

US00D940680S

(12) **United States Design Patent** (10) **Patent No.:** **US D940,680 S**
Lee et al. (45) **Date of Patent:** **** *Jan. 11, 2022**

(54) **MOBILE PHONE**

FOREIGN PATENT DOCUMENTS

(71) Applicant: **LG ELECTRONICS INC.**, Seoul (KR)

CN 303329651 * 8/2015
CN 304509551 * 2/2018

(Continued)

(72) Inventors: **Jonghak Lee**, Seoul (KR); **Hongkyu Park**, Seoul (KR); **Jinki Min**, Seoul (KR); **Seunghyun Ji**, Seoul (KR); **Sojin Kim**, Seoul (KR)

OTHER PUBLICATIONS

Internet Publication by GadgetMatch, Rollable display smartphones, Publication Date: Mar. 5, 2020, [online], [retrieved on Aug. 24, 2021], Retrieved from Internet ,<URL: <https://www.youtube.com/watch?v=uzExejMsVOY>>.*

(Continued)

(73) Assignee: **LG ELECTRONICS INC.**, Seoul (KR)

Primary Examiner — Bridget L Eland

(*) Notice: This patent is subject to a terminal disclaimer.

(74) *Attorney, Agent, or Firm* — Birch, Stewart, Kolasch & Birch, LLP

(**) Term: **15 Years**

(57) **CLAIM**

The ornamental design for a mobile phone, as shown and described.

(21) Appl. No.: **29/722,928**

DESCRIPTION

(22) Filed: **Feb. 3, 2020**

(30) **Foreign Application Priority Data**

Aug. 8, 2019 (JP) 2019-017787

(51) **LOC (13) Cl.** **14-03**

(52) **U.S. Cl.**
USPC **D14/138 AD**

(58) **Field of Classification Search**
USPC D14/138 G, 138 AD, 248, 341, 345, 432,
D14/439, 371, 374, 138 R, 138 AA,
D14/138 AB, 138 AC, 138 C
(Continued)

FIG. 1 is a front perspective view of the mobile phone showing our new design;
FIG. 2 is a front view thereof;
FIG. 3 is a rear view thereof;
FIG. 4 is a left side view thereof;
FIG. 5 is a right side view thereof;
FIG. 6 is a top plan view thereof;
FIG. 7 is a bottom plan view thereof;
FIG. 8 is a rear perspective view thereof;
FIG. 9 is a rear perspective view of the mobile phone of FIG. 1, shown with environment;
FIG. 10 is a front perspective view of the mobile phone of FIG. 1, shown in an open state;
FIG. 11 is a front view of FIG. 10;
FIG. 12 is a rear view of FIG. 10;
FIG. 13 is a left side view of FIG. 10;
FIG. 14 is a right side view of FIG. 10;
FIG. 15 is a top plan view of FIG. 10;
FIG. 16 is a bottom plan view of FIG. 10; and,
FIG. 17 is a rear perspective view of FIG. 10.

(Continued)

(56) **References Cited**

U.S. PATENT DOCUMENTS

D594,028 S * 6/2009 Fuchsberg D14/496
D606,961 S * 12/2009 Aarras D14/138 AD

(Continued)

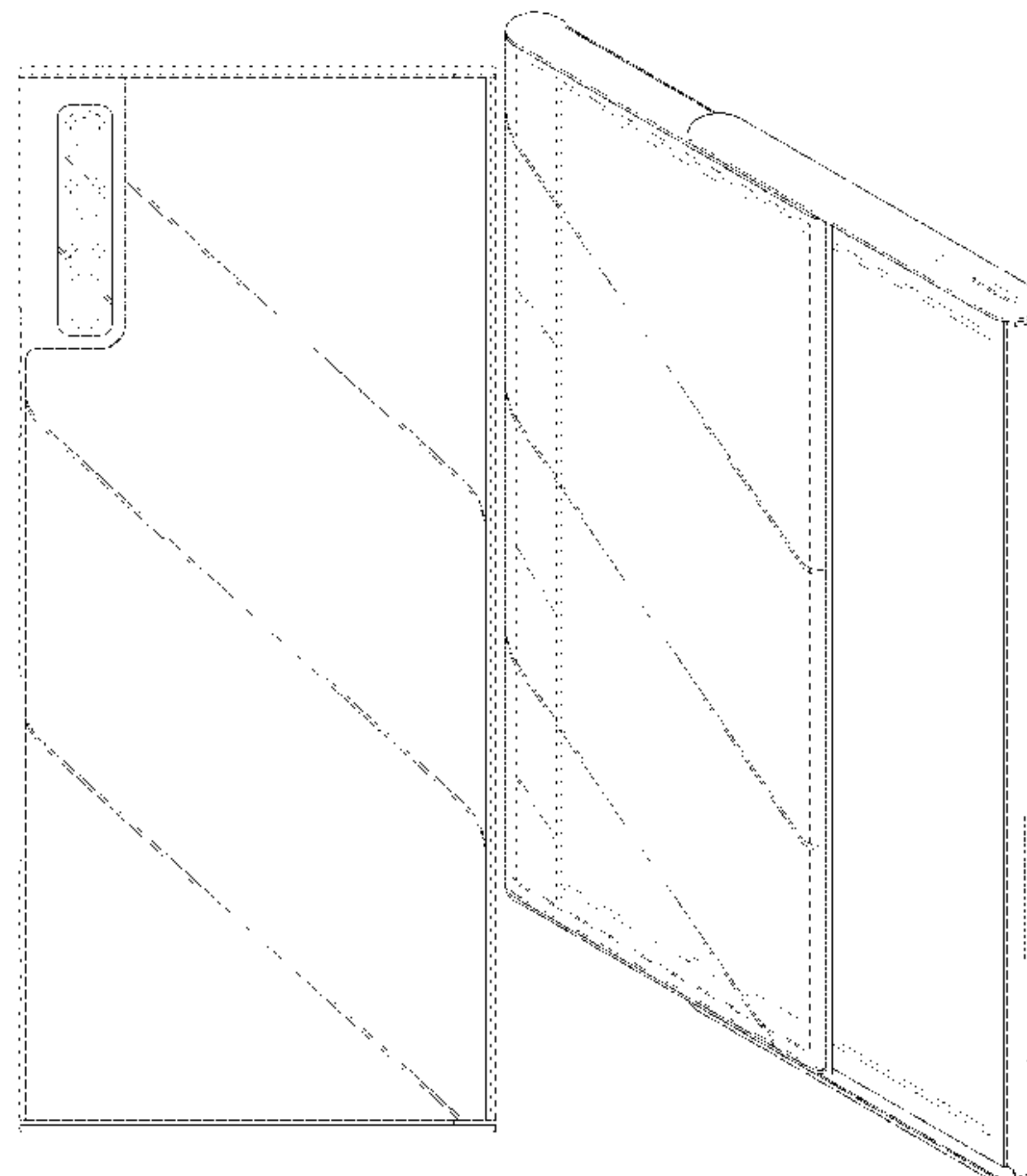

The broken lines depict portions of the mobile phone that form no part of the claimed design.

1 Claim, 17 Drawing Sheets

(58) **Field of Classification Search**

CPC H04M 1/0202; H04M 1/0235; H04M 1/0237; H04M 1/0239; H04M 1/0266; H04M 1/0268; H04M 1/027; H04M 1/0295; H04M 1/02; H04M 1/0279; H04M 1/0283

See application file for complete search history.

(56) **References Cited**

U.S. PATENT DOCUMENTS

D622,253 S * 8/2010 Park D14/138 G
 D631,458 S * 1/2011 Liao D14/138 G
 D676,818 S * 2/2013 Park D14/138 G
 D698,341 S * 1/2014 Lee D14/248
 D712,401 S * 9/2014 Lee D14/341
 D716,253 S * 10/2014 Lee D14/138 AB
 D717,262 S * 11/2014 Phillips D14/138 G
 D722,036 S * 2/2015 Nam D14/138 G
 D750,063 S * 2/2016 Chung D14/341
 D750,067 S * 2/2016 Park D14/341
 D750,617 S * 3/2016 Akana D14/341
 D757,716 S * 5/2016 Park D14/341
 D757,718 S * 5/2016 Park D14/341
 D761,253 S * 7/2016 Yamazaki D14/341
 D766,891 S * 9/2016 Hong D14/341
 D768,594 S * 10/2016 Szeto D14/138 G
 D777,700 S * 1/2017 Kwon D14/138 G
 D778,863 S * 2/2017 Lee D14/138 AD
 D784,945 S * 4/2017 Choo D14/138 AB
 D794,004 S * 8/2017 Kwon D14/248
 D794,005 S * 8/2017 Kwon D14/248
 D794,623 S * 8/2017 Kwon D14/248
 D795,825 S * 8/2017 Kim D14/138 R
 D798,851 S * 10/2017 Kim D14/248
 D798,852 S * 10/2017 Kim D14/248
 D871,397 S * 12/2019 Seo D14/341
 10,553,135 B2 * 2/2020 Lee G02F 1/133305
 D890,113 S * 7/2020 Ma D14/138 G
 D896,769 S * 9/2020 Lee D14/138 AD
 D897,301 S * 9/2020 Lee D14/138 AB
 D899,408 S * 10/2020 Seo D14/248
 D901,418 S * 11/2020 Ma D14/138 G
 10,880,417 B1 * 12/2020 Song H04M 1/0237
 D907,614 S * 1/2021 Kim D14/248
 D912,045 S * 3/2021 Han D14/341
 10,936,017 B1 * 3/2021 Choi G06F 1/1643

10,955,876 B1 * 3/2021 Song H04M 1/0268
 D915,334 S * 4/2021 Lee D14/138 AD
 D915,335 S * 4/2021 Lee D14/138 AD
 D915,336 S * 4/2021 Lee D14/138 AD
 D923,598 S * 6/2021 Lee D14/138 AD
 D926,718 S * 8/2021 Lee D14/138 AD
 2012/0314400 A1 * 12/2012 Bohn G06F 1/1652
 362/97.1
 2013/0058063 A1 * 3/2013 O'Brien G06F 1/1652
 361/807
 2020/0253063 A1 * 8/2020 Jiang G06F 1/1652
 2020/0264660 A1 * 8/2020 Song H04M 1/0268
 2020/0267246 A1 * 8/2020 Song G06F 1/1624
 2021/0004055 A1 * 1/2021 Chueh G06F 1/1624

FOREIGN PATENT DOCUMENTS

CN 304509556 * 2/2018
 CN 305307457 * 8/2019

OTHER PUBLICATIONS

Internet Publication by TechAvid, LG's Rollable Phone, Publication Date: Dec. 7, 2020, [online], [retrieved on Aug. 24, 2021]. Retrieved from Internet ,<URL: <https://www.youtube.com/watch?v=tZK6a4-GunE>>.*
 Internet Publication by Creator Studio, Oppo Rollable Display Phone, Publication Date: Nov. 17, 2020, [online], [retrieved on Aug. 24, 2021]. Retrieved from Internet ,<URL: <https://www.youtube.com/watch?v=CUTmYqJcVpQ>>.*
 Internet Publication by Kelvin, Oppo X 2021 Rollable Concept Phone, Publication Date: Nov. 18, 2020, [online], [retrieved on Aug. 24, 2021]. Retrieved from Internet ,<URL: <https://www.concept-phones.com/news/oppo-x-2021-rollable-concept-phone-truly-looks-like-the-next-big-thing/>>.*
 Internet Publication by Kelvin, The Scroll is Back!, Publication Date: Mar. 14, 2018, [online], [retrieved on Aug. 24, 2021]. Retrieved from Internet ,<URL: <https://www.concept-phones.com/samsung/scroll-flexible-device-scrollable-part-coming/>>.*
 Internet Publication by Kelvin, LG Rollable Phone Versus TCL Rollable Phone, Publication Date: Jan. 14, 2021, [online], [retrieved on Aug. 24, 2021]. Retrieved from Internet ,<URL: <https://www.concept-phones.com/lg/lg-rollable-phone-versus-tcl-rollable-phone-who-won-ces-2021/>>.*
 Internet Publication by Daniel Petrov, Shh, Samsung will demo phone, Publication Date: Jan. 7, 2020, [online], [retrieved on Aug. 24, 2021]. Retrieved from Internet ,<URL: https://www.phonearena.com/news/samsung-slide-display-phone-ces-2020_id121415>.*
 Internet Publication by Mars Gadgets, Top 5 Rollable Phones, Publication Date: Nov. 25, 2020, [online], [retrieved on Aug. 24, 2021]. Retrieved from Internet ,<URL: <https://www.youtube.com/watch?v=Zjoft-71k8U>>.*

* cited by examiner

FIG. 1

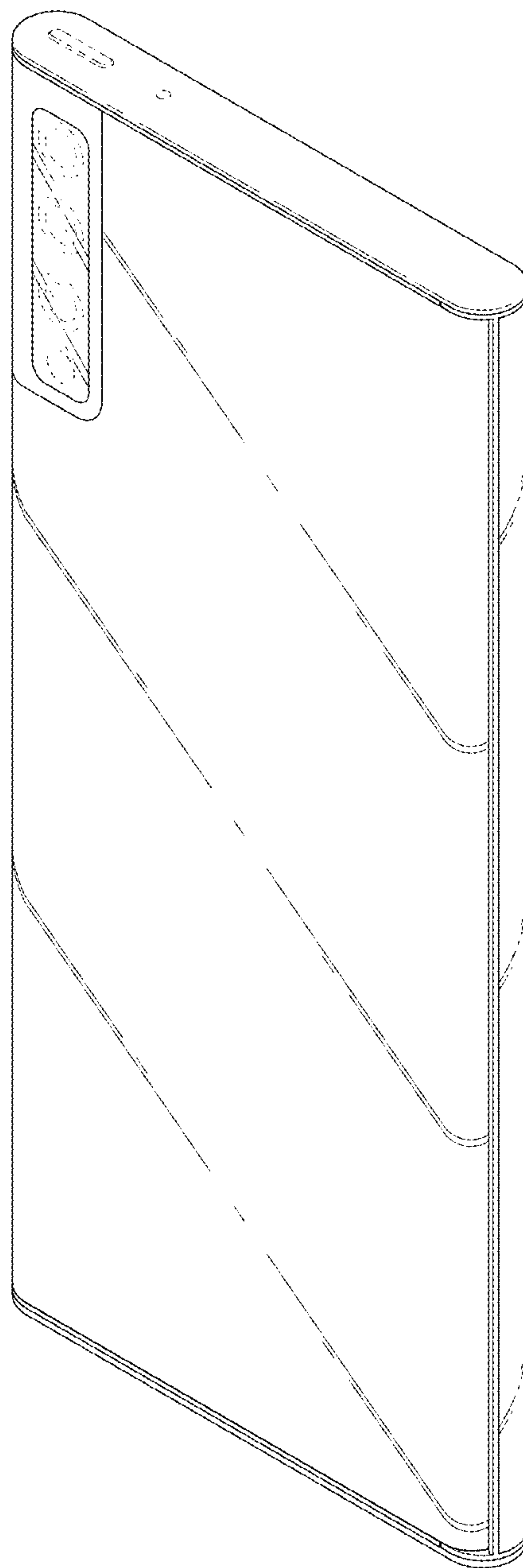

FIG. 2

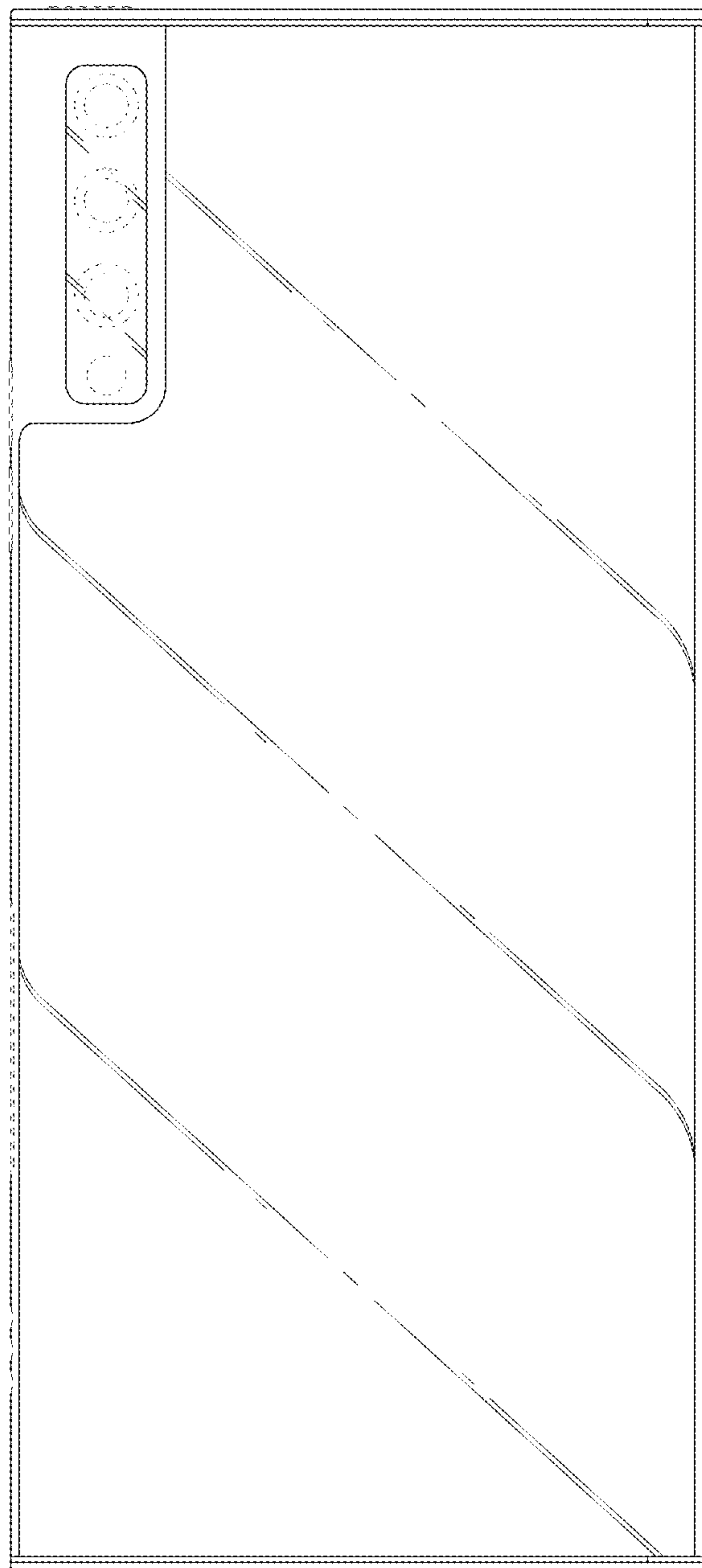

FIG. 3

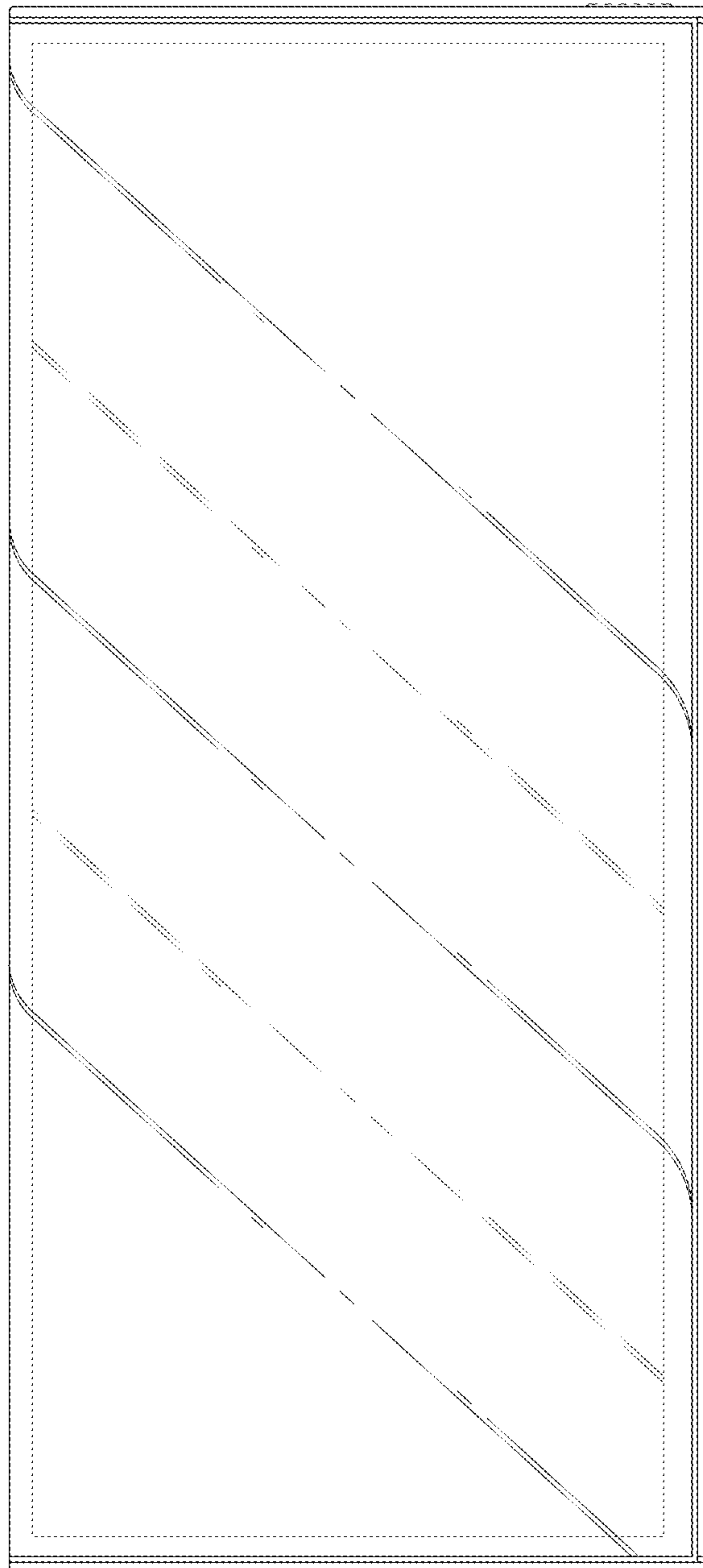

FIG. 4

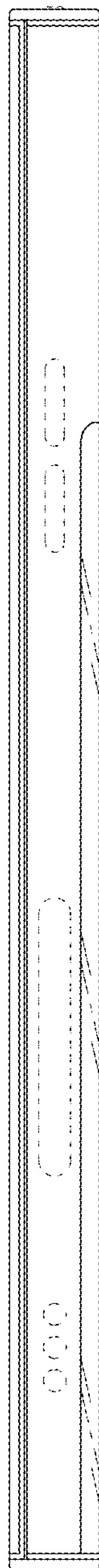

FIG. 5



FIG. 6



FIG. 7



FIG. 8

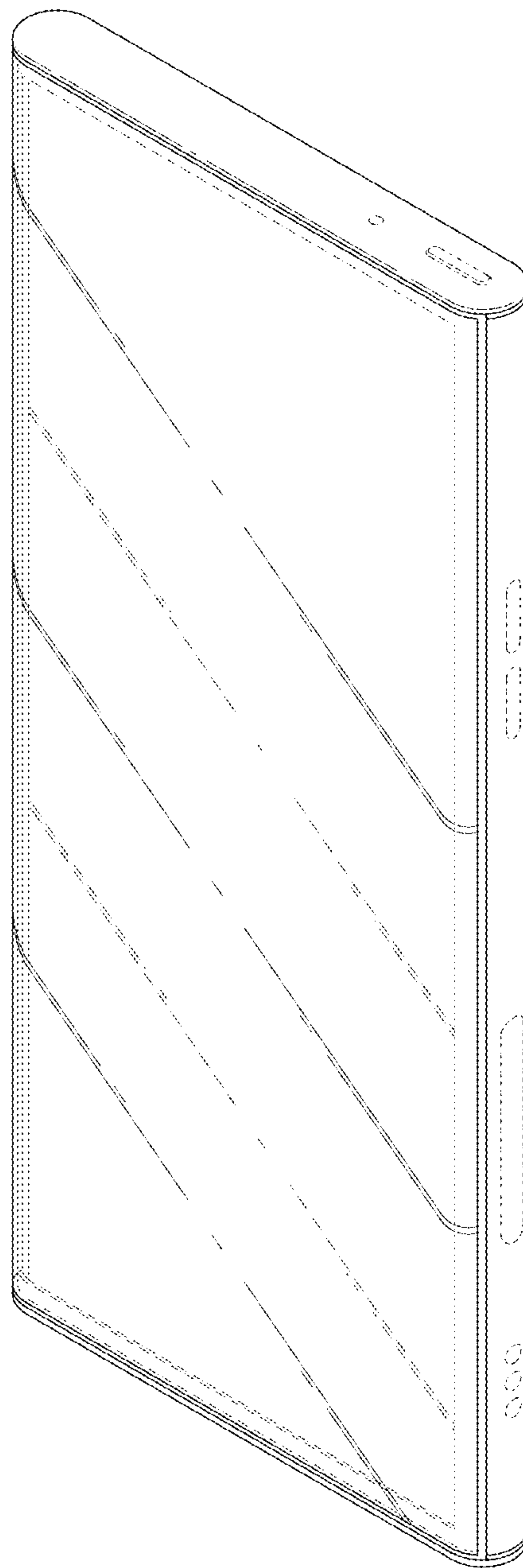

FIG. 9

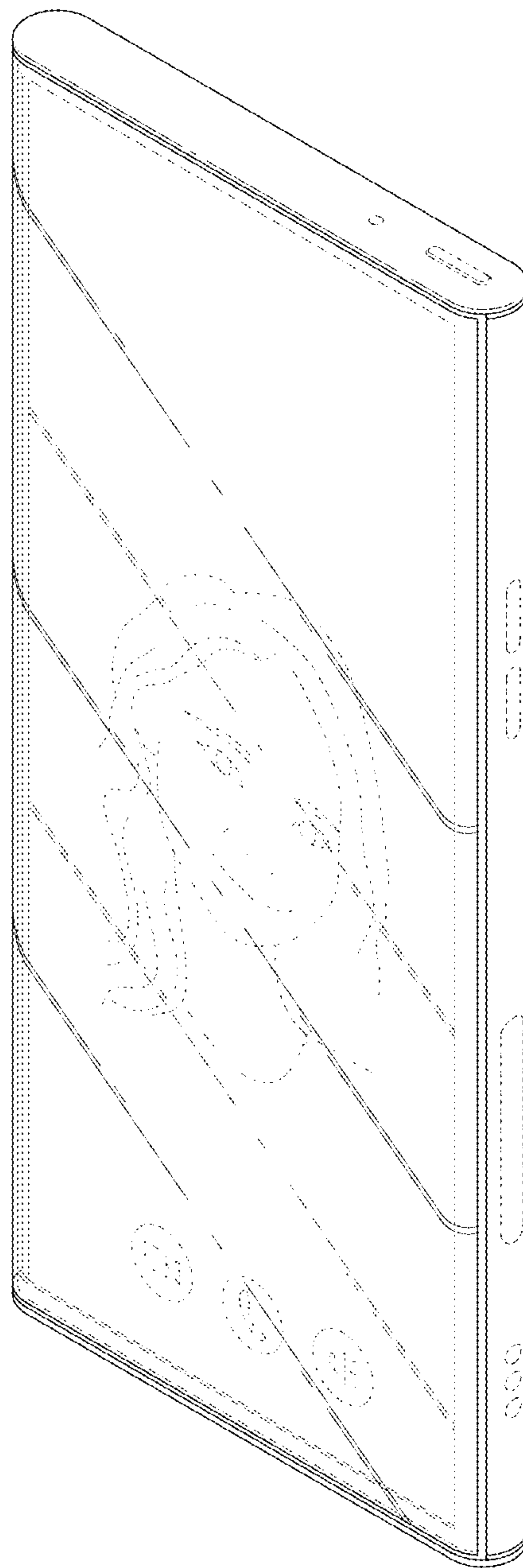

FIG. 10

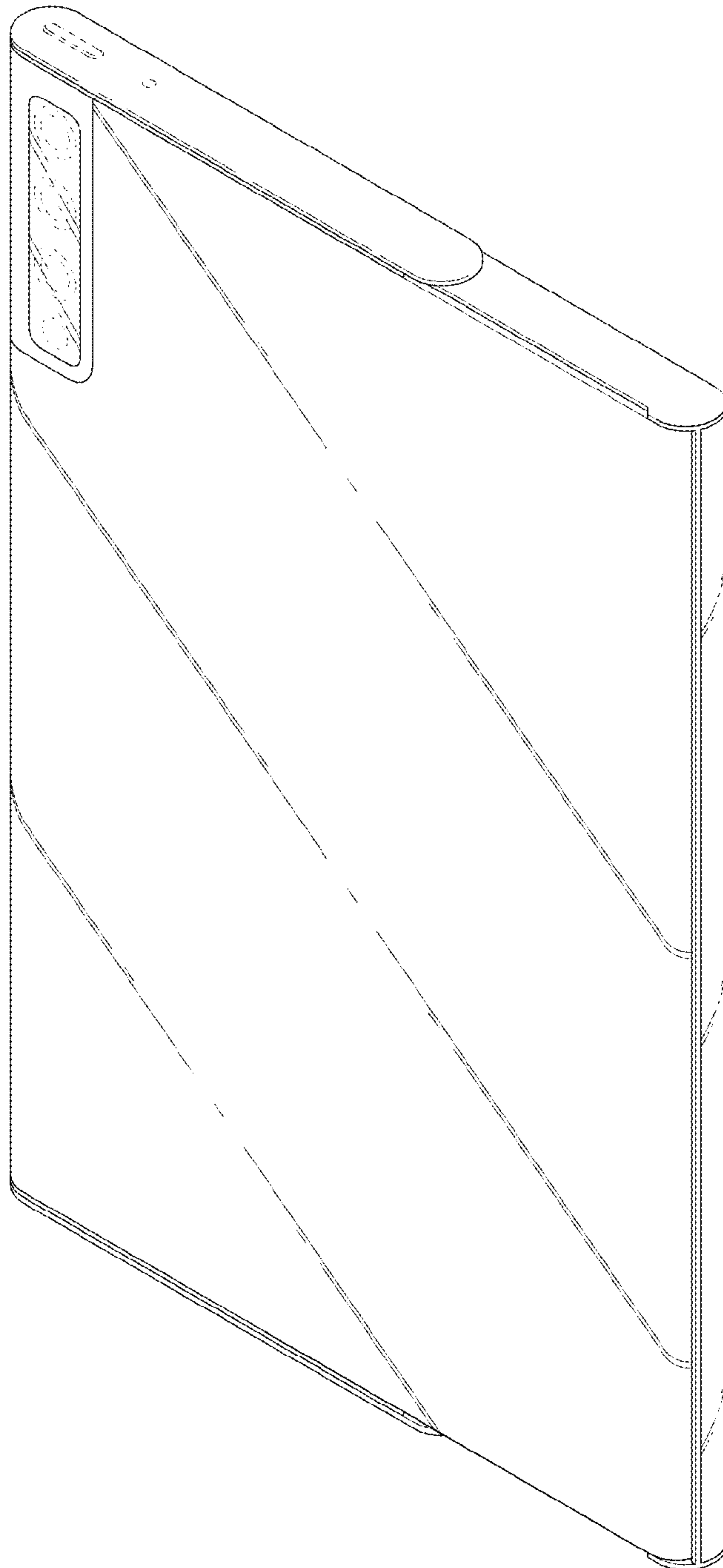

FIG. 11

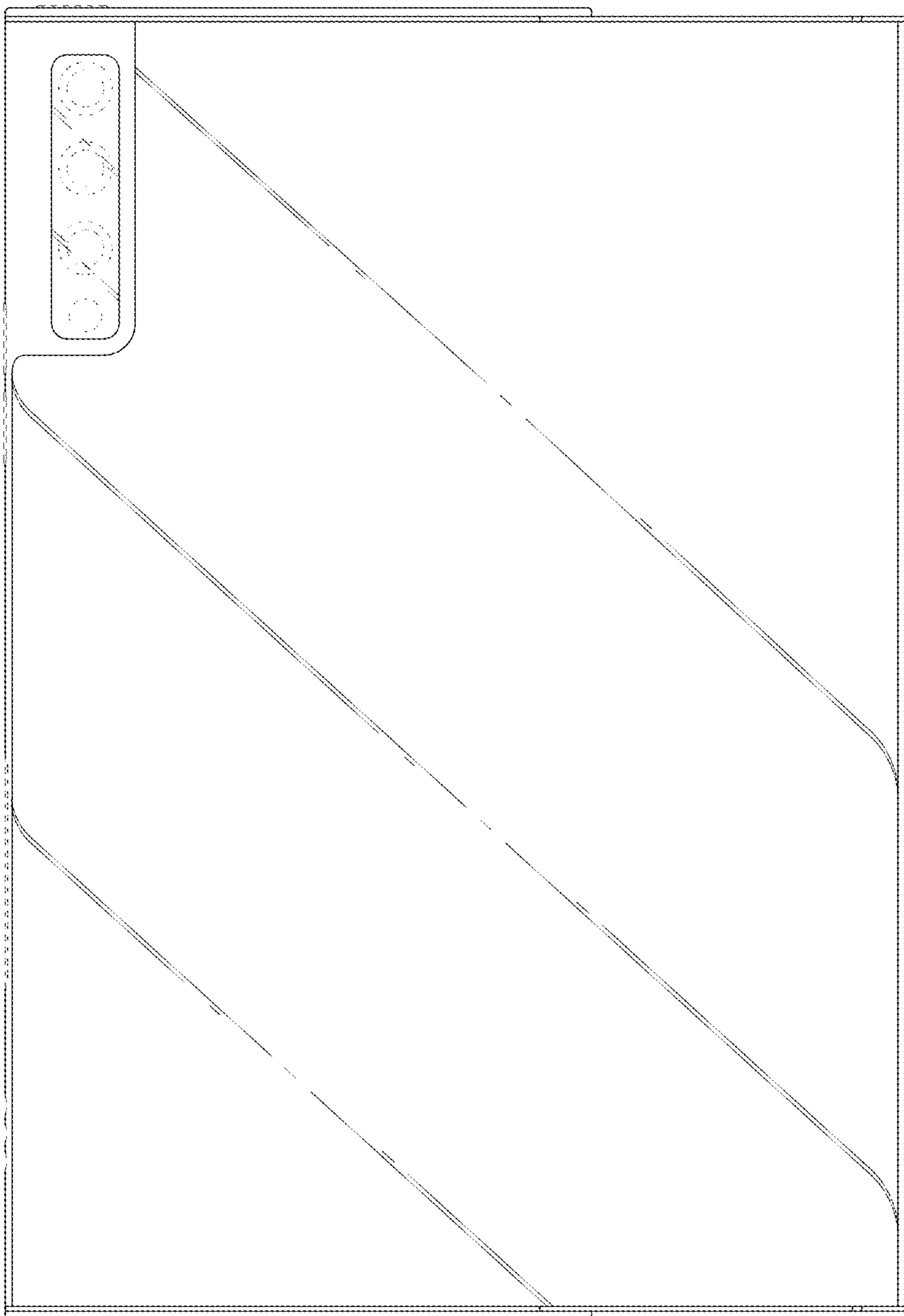

FIG. 12

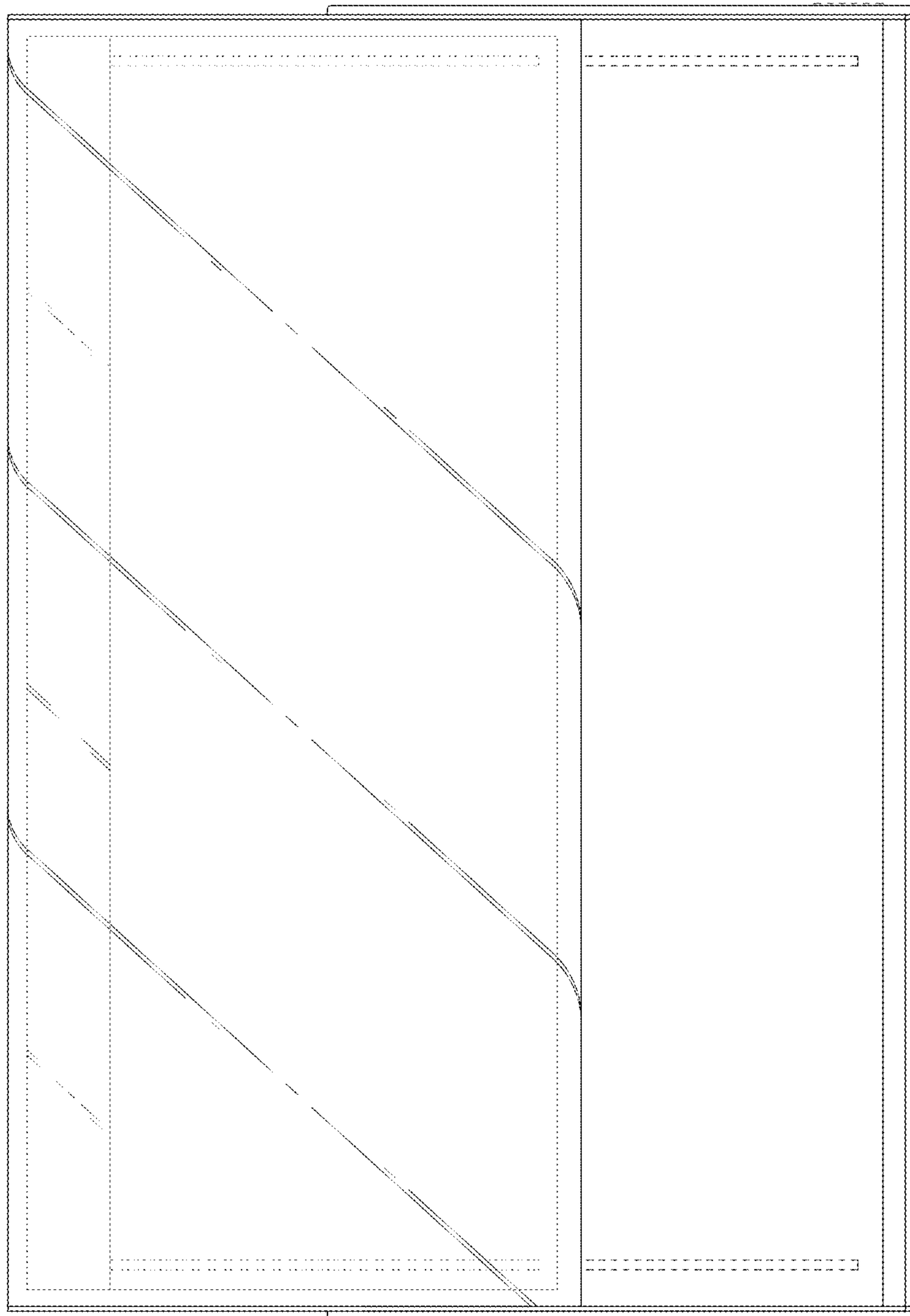

FIG. 13

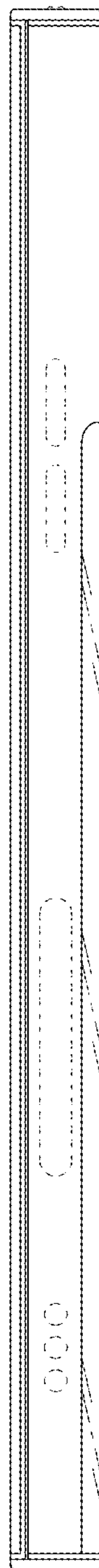

FIG. 14

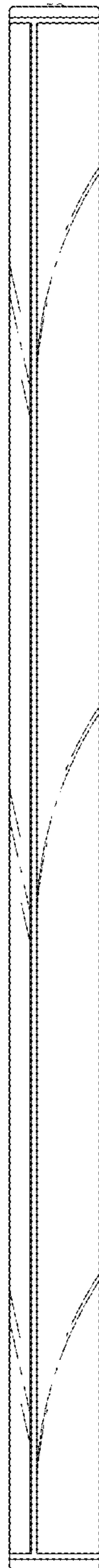

FIG. 15

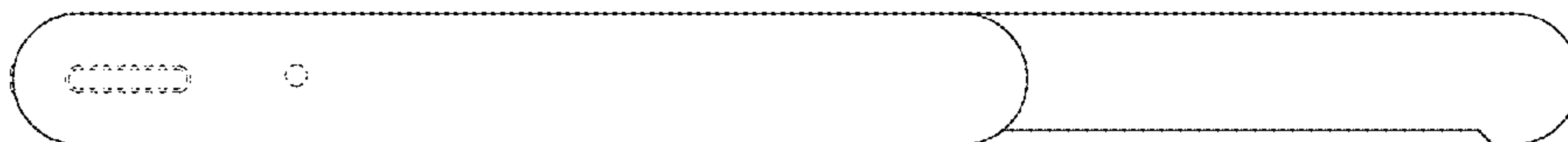

FIG. 16



FIG. 17

