



US00D940679S

(12) **United States Design Patent** (10) **Patent No.:** **US D940,679 S**  
**Min et al.** (45) **Date of Patent:** **\*\* \*Jan. 11, 2022**

(54) **MOBILE PHONE**

FOREIGN PATENT DOCUMENTS

(71) Applicant: **LG ELECTRONICS INC.**, Seoul (KR)

CN 303329651 \* 8/2015  
CN 304509551 \* 2/2018

(Continued)

(72) Inventors: **Jinki Min**, Seoul (KR); **Sojin Kim**, Seoul (KR); **Hongkyu Park**, Seoul (KR); **Jonghak Lee**, Seoul (KR); **Seunghyun Ji**, Seoul (KR)

OTHER PUBLICATIONS

Internet Publication by GadgetMatch, Rollable display smartphones, Publication Date: Mar. 5, 2020, [online], [retrieved on Aug. 24, 2021]. Retrieved from Internet ,<URL: <https://www.youtube.com/watch?v=uzExejMsVOY>>.\*

(Continued)

(73) Assignee: **LG ELECTRONICS INC.**, Seoul (KR)

(\* ) Notice: This patent is subject to a terminal disclaimer.

*Primary Examiner* — Bridget L Eland

(\*\*) Term: **15 Years**

(74) *Attorney, Agent, or Firm* — Birch, Stewart, Kolasch & Birch, LLP

(21) Appl. No.: **29/720,293**

(22) Filed: **Jan. 10, 2020**

(57) **CLAIM**

(30) **Foreign Application Priority Data**

The ornamental design for a mobile phone, as shown and described.

Jul. 11, 2019 (JP) ..... 2019-015680

(51) **LOC (13) Cl.** ..... **14-03**

(52) **U.S. Cl.**  
USPC ..... **D14/138 AD**

(58) **Field of Classification Search**  
USPC .... D14/138 G, 138 AD, 248, 341, 345, 432, D14/439, 371, 374, 138 R, 138 AA, D14/138 AB, 138 AC, 138 C  
CPC ..... H04M 1/0202; H04M 1/0235; H04M 1/0237; H04M 1/0239; H04M 1/0266; H04M 1/0268; H04M 1/027; H04M 1/0295; H04M 1/02; H04M 1/0279; H04M 1/0283

See application file for complete search history.

**DESCRIPTION**

FIG. 1 is a front perspective view of the mobile phone showing our new design;  
FIG. 2 is a front view thereof;  
FIG. 3 is a rear view thereof;  
FIG. 4 is a left side view thereof;  
FIG. 5 is a right side view thereof;  
FIG. 6 is a top plan view thereof;  
FIG. 7 is a bottom plan view thereof;  
FIG. 8 is a rear perspective view thereof;  
FIG. 9 is a front perspective view of the mobile phone of FIG. 1, shown with environment; and,  
FIG. 10 is a rear perspective view of the mobile phone of FIG. 1, shown with environment.  
The broken lines depict portions of the mobile phone that form no part of the claimed design.

(56) **References Cited**

U.S. PATENT DOCUMENTS

D594,028 S \* 6/2009 Fuchsberg ..... D14/496  
D606,961 S \* 12/2009 Aarras ..... D14/138 AD

(Continued)

**1 Claim, 10 Drawing Sheets**

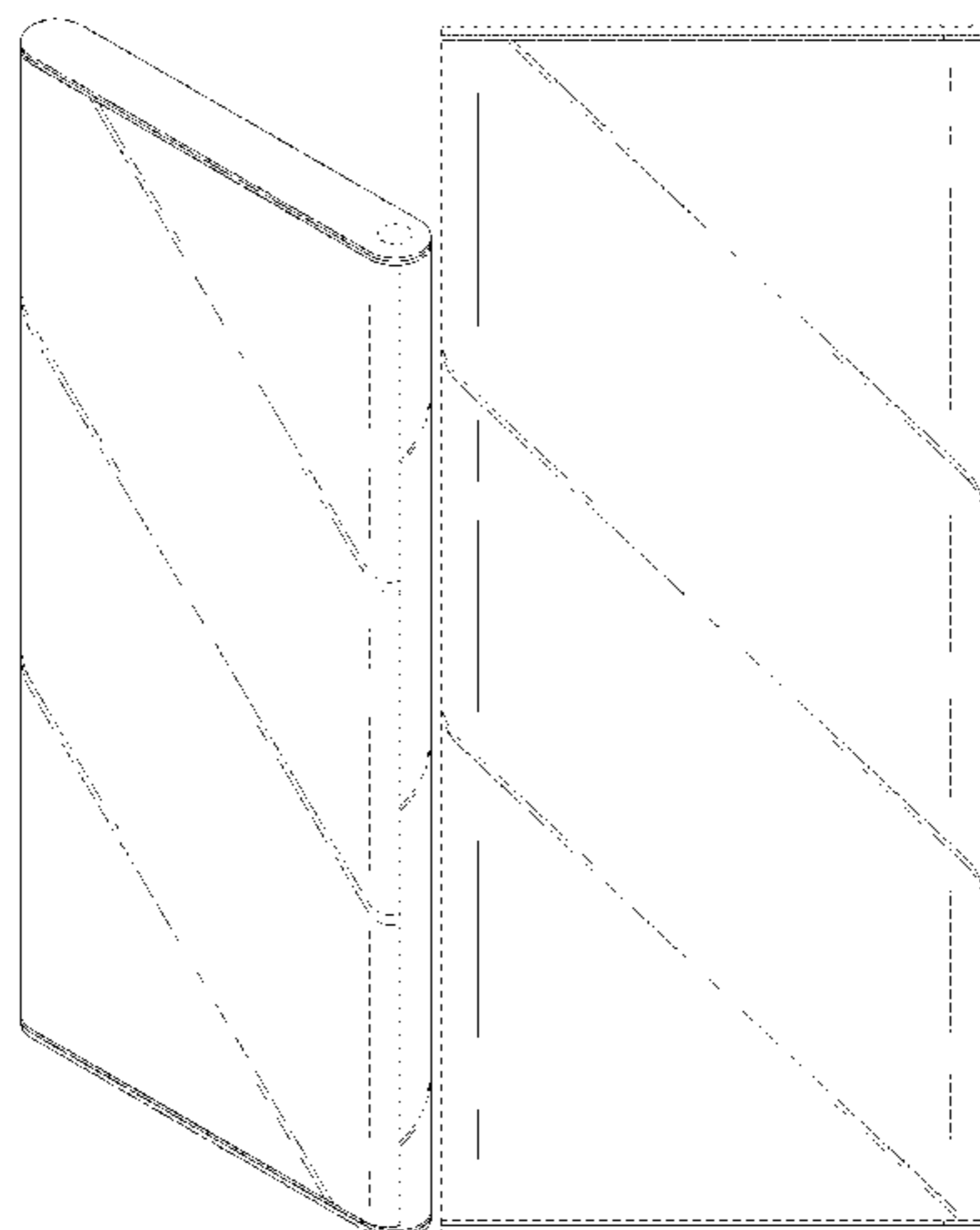

(56)

## References Cited

## U.S. PATENT DOCUMENTS

D622,253 S \* 8/2010 Park ..... D14/138 G  
 D631,458 S \* 1/2011 Liao ..... D14/138 G  
 D676,818 S \* 2/2013 Park ..... D14/138 G  
 D698,341 S \* 1/2014 Lee ..... D14/248  
 D712,401 S \* 9/2014 Lee ..... D14/341  
 D716,253 S \* 10/2014 Lee ..... D14/138 AB  
 D717,262 S \* 11/2014 Phillips ..... D14/138 G  
 D722,036 S \* 2/2015 Nam ..... D14/138 G  
 D750,063 S \* 2/2016 Chung ..... D14/341  
 D750,067 S \* 2/2016 Park ..... D14/341  
 D750,617 S \* 3/2016 Akana ..... D14/341  
 D757,716 S \* 5/2016 Park ..... D14/341  
 D757,718 S \* 5/2016 Park ..... D14/341  
 D761,253 S \* 7/2016 Yamazaki ..... D14/341  
 D766,891 S \* 9/2016 Hong ..... D14/341  
 D768,594 S \* 10/2016 Szeto ..... D14/138 G  
 D777,700 S \* 1/2017 Kwon ..... D14/138 G  
 D778,863 S \* 2/2017 Lee ..... D14/138 AD  
 D784,945 S \* 4/2017 Choo ..... D14/138 AB  
 D794,004 S \* 8/2017 Kwon ..... D14/248  
 D794,005 S \* 8/2017 Kwon ..... D14/248  
 D794,623 S \* 8/2017 Kwon ..... D14/248  
 D795,825 S \* 8/2017 Kim ..... D14/138 R  
 D798,851 S \* 10/2017 Kim ..... D14/248  
 D798,852 S \* 10/2017 Kim ..... D14/248  
 D871,397 S \* 12/2019 Seo ..... D14/341  
 10,553,135 B2 \* 2/2020 Lee ..... G02F 1/133305  
 D890,113 S \* 7/2020 Ma ..... D14/138 G  
 D896,769 S \* 9/2020 Lee ..... D14/138 AD  
 D897,301 S \* 9/2020 Lee ..... D14/138 AB  
 D899,408 S \* 10/2020 Seo ..... D14/248  
 D901,418 S \* 11/2020 Ma ..... D14/138 G  
 10,880,417 B1 \* 12/2020 Song ..... H04M 1/0237  
 D907,614 S \* 1/2021 Kim ..... D14/248  
 D912,045 S \* 3/2021 Han ..... D14/341  
 10,936,017 B1 \* 3/2021 Choi ..... G06F 1/1643  
 10,955,876 B1 \* 3/2021 Song ..... H04M 1/0268  
 D915,334 S \* 4/2021 Lee ..... D14/138 AD  
 D915,335 S \* 4/2021 Lee ..... D14/138 AD  
 D915,336 S \* 4/2021 Lee ..... D14/138 AD  
 D923,598 S \* 6/2021 Lee ..... D14/138 AD  
 D926,718 S \* 8/2021 Lee ..... D14/138 AD  
 2012/0314400 A1 \* 12/2012 Bohn ..... G06F 1/1652  
 362/97.1  
 2013/0058063 A1 \* 3/2013 O'Brien ..... G06F 1/1652  
 361/807

2020/0253063 A1 \* 8/2020 Jiang ..... G06F 1/1652  
 2020/0264660 A1 \* 8/2020 Song ..... H04M 1/0268  
 2020/0267246 A1 \* 8/2020 Song ..... G06F 1/1624  
 2021/0004055 A1 \* 1/2021 Chueh ..... G06F 1/1624

## FOREIGN PATENT DOCUMENTS

CN 304509556 \* 2/2018  
 CN 305307457 \* 8/2019

## OTHER PUBLICATIONS

Internet Publication by TechAvid, LG's Rollable Phone, Publication Date: Dec. 7, 2020, [online], [retrieved on Aug. 24, 2021]. Retrieved from Internet ,<URL: <https://www.youtube.com/watch?v=tZK6a4-GunE>>.\*

Internet Publication by Creator Studio, Oppo Rollable Display Phone, Publication Date: Nov. 17, 2020, [online], [retrieved on Aug. 24, 2021]. Retrieved from Internet ,<URL: <https://www.youtube.com/watch?v=CUTmYqJcVpQ>>.\*

Internet Publication by Kelvin, Oppo X 2021 Rollable Concept Phone, Publication Date: Nov. 18, 2020, [online], [retrieved on Aug. 24, 2021]. Retrieved from Internet ,<URL: <https://www.concept-phones.com/news/oppo-x-2021-rollable-concept-phone-truly-looks-like-the-next-big-thing/>>.\*

Internet Publication by Kelvin, The Scroll is Back!, Publication Date: Mar. 14, 2018, [online], [retrieved on Aug. 24, 2021]. Retrieved from Internet ,<URL: <https://www.concept-phones.com/samsung/scroll-flexible-device-scrollable-part-coming/>>.\*

Internet Publication by Kelvin, LG Rollable Phone Versus TCL Rollable Phone, Publication Date: Jan. 14, 2021, [online], [retrieved on Aug. 24, 2021]. Retrieved from Internet ,<URL: <https://www.concept-phones.com/lg/lg-rollable-phone-versus-tcl-rollable-phone-who-won-ces-2021/>>.\*

Internet Publication by Daniel Petrov, Shh, Samsung will demo phone, Publication Date: Jan. 7, 2020, [online], [retrieved on Aug. 24, 21]. Retrieved from Internet ,<URL: [https://www.phonearena.com/news/samsung-slide-display-phone-ces-2020\\_id121415](https://www.phonearena.com/news/samsung-slide-display-phone-ces-2020_id121415)>.\*

Internet Publication by Mars Gadgets, Top 5 Rollable Phones, Publication Date: Nov. 25, 2020, [online], [retrieved on Aug. 24, 2021]. Retrieved from Internet ,<URL: <https://www.youtube.com/watch?v=Zjoft-71k8U>>.\*

\* cited by examiner

FIG. 1

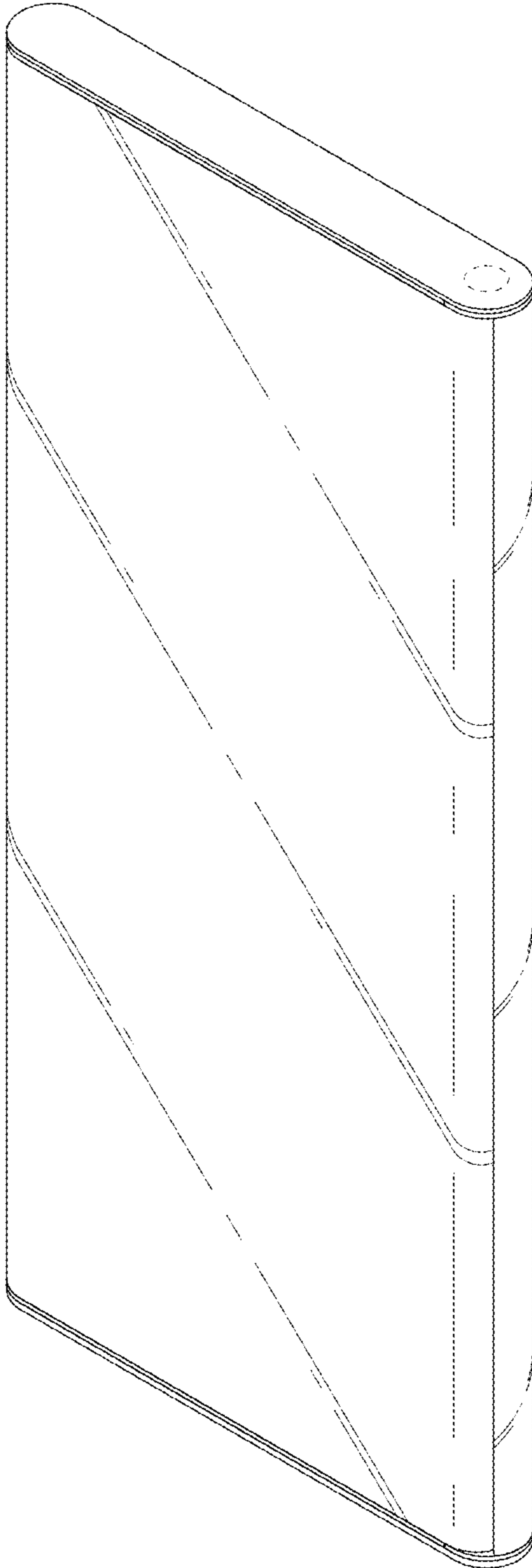

FIG. 2

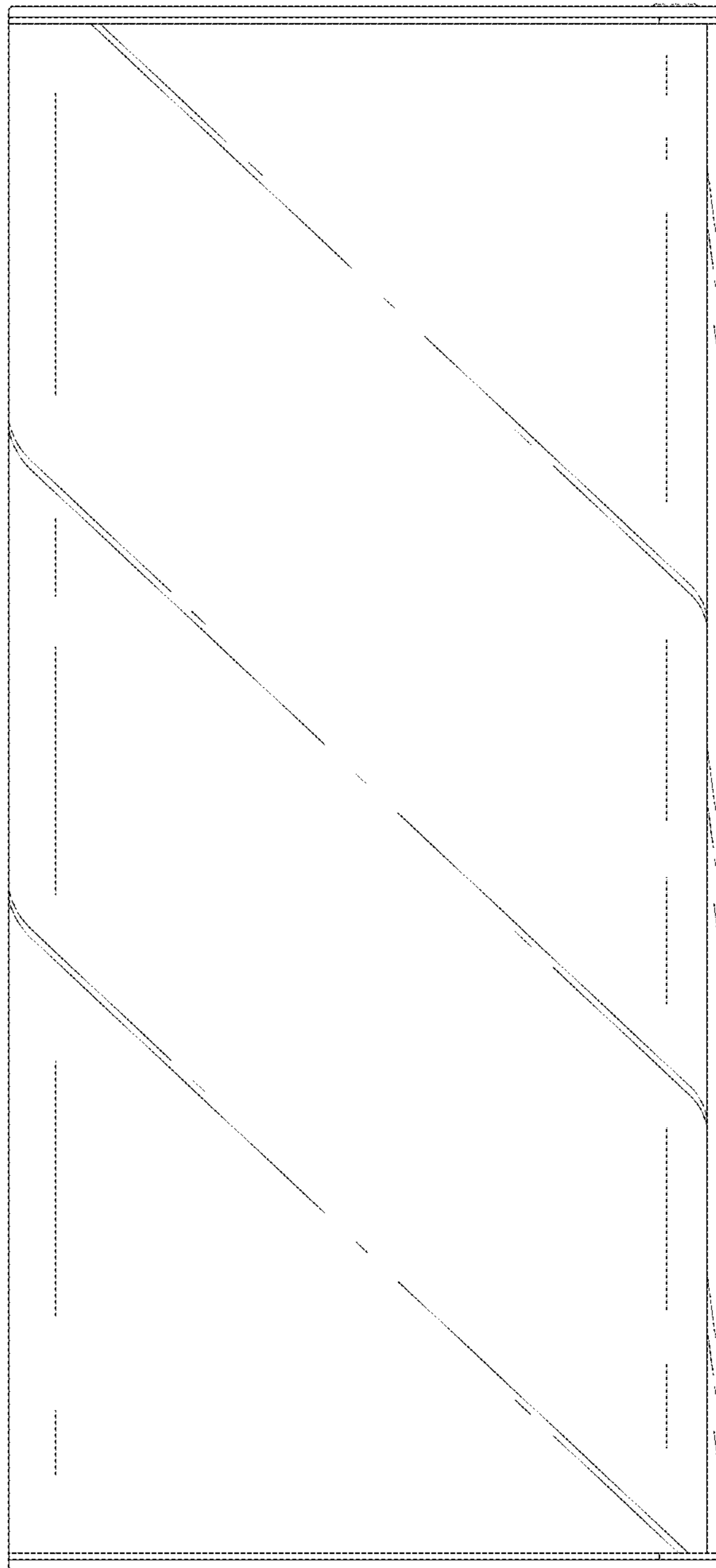

FIG. 3

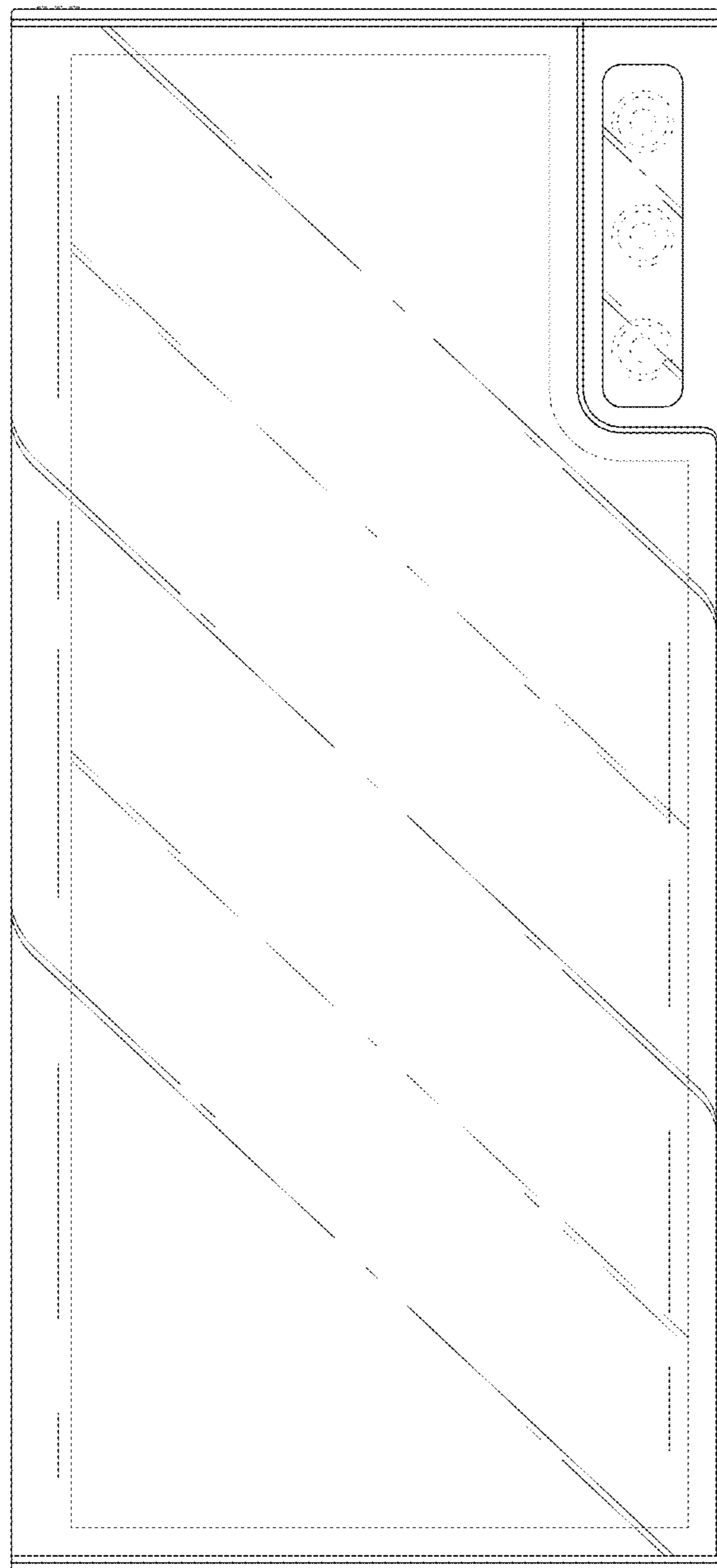

FIG. 4

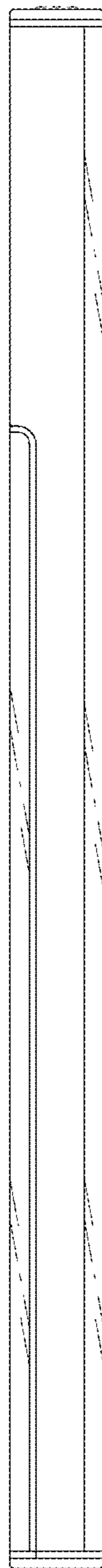

FIG. 5

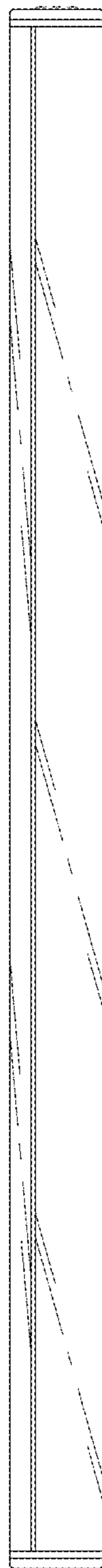

FIG. 6

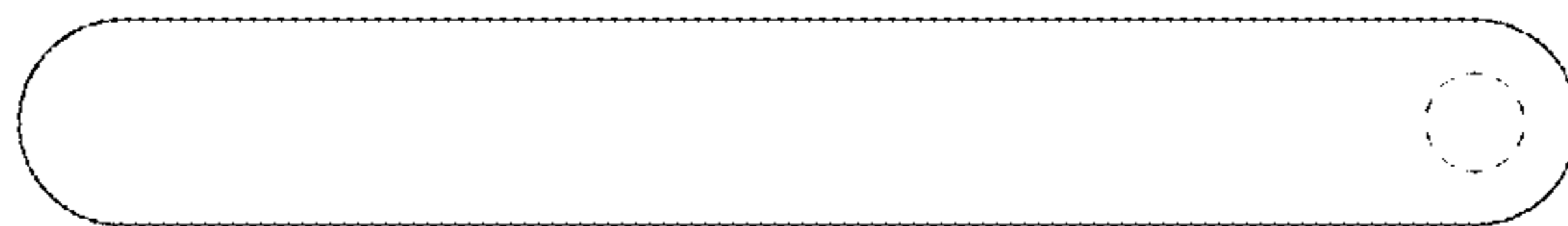



FIG. 7



FIG. 8

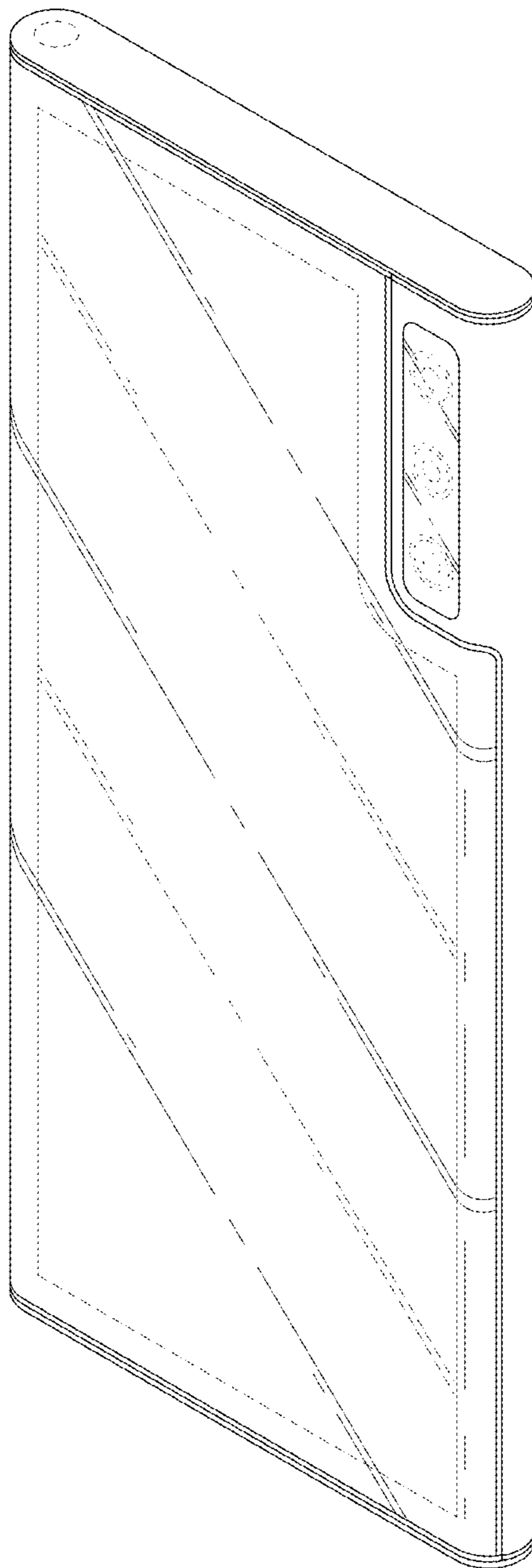

FIG. 9

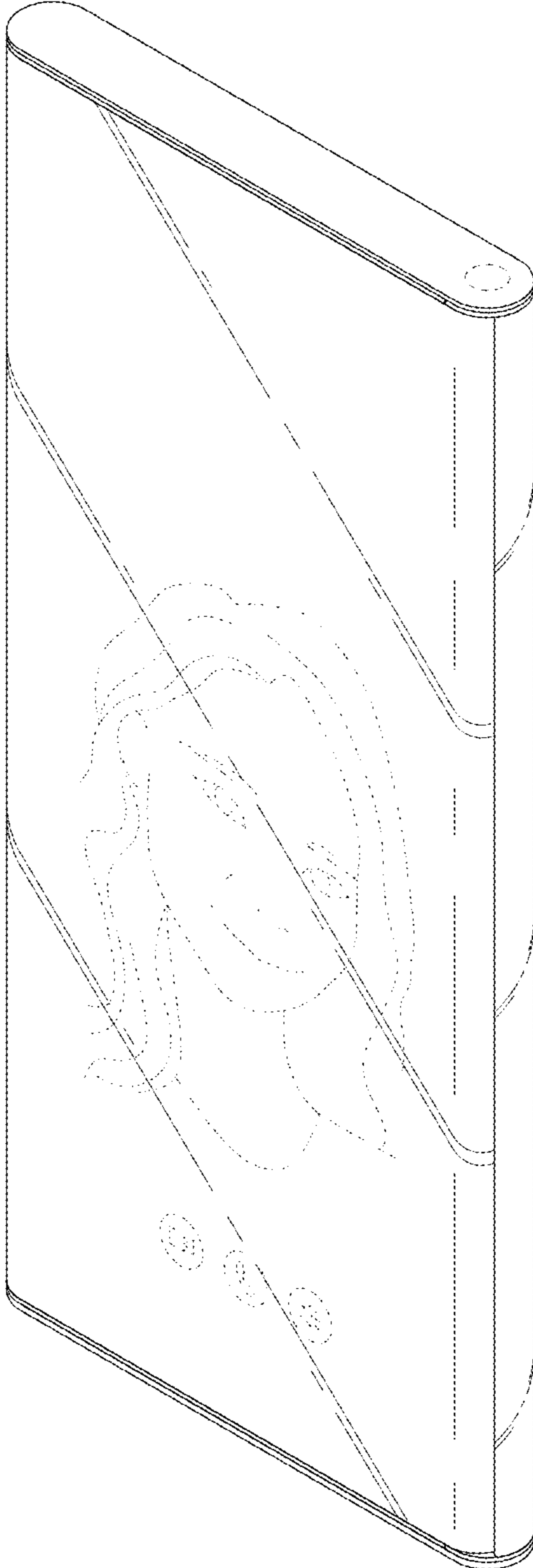

FIG. 10

