



US00D940515S

(12) **United States Design Patent** (10) **Patent No.:** **US D940,515 S**  
**Li** (45) **Date of Patent:** **\*\* Jan. 11, 2022**

(54) **FRESH-KEEPING BAG**  
(71) Applicant: **Caiyun Li**, Hunan Province (CN)  
(72) Inventor: **Caiyun Li**, Hunan Province (CN)  
(\*\*) Term: **15 Years**

D699,128 S \* 2/2014 Moynihan ..... D9/707  
D701,125 S \* 3/2014 Propper ..... D9/709  
D707,042 S \* 6/2014 Ruzzenente ..... D3/273  
D711,251 S \* 8/2014 Epstein ..... D9/707  
D718,529 S \* 12/2014 Wang ..... D3/290  
(Continued)

(21) Appl. No.: **29/725,331**  
(22) Filed: **Feb. 24, 2020**  
(51) **LOC (13) Cl.** ..... **09-07**  
(52) **U.S. Cl.**  
USPC ..... **D7/629**; D9/709  
(58) **Field of Classification Search**  
USPC ..... D7/605, 607, 629, 705, 709; D3/205,  
D3/231-232, 240-246, 254, 258, 262,  
D3/267, 276, 283-291, 301, 303-305,  
D3/324, 326-327, 902, 201, 239;  
D9/737, 761-762, 704, 708-709  
CPC .. A47J 47/02; A47J 47/06; A47J 47/10; A47J  
47/14; A47G 23/04; A47G 23/0683  
See application file for complete search history.

**FOREIGN PATENT DOCUMENTS**

CA 173458 \* 1/2018  
CN 305497346 \* 12/2019  
(Continued)

**OTHER PUBLICATIONS**

Reusable Silicone Food Storage Bag, Gshine, amazon.com, published by Gshine, first available on Jan. 9, 2020 © 1996-2021 Amazon.com, Inc. online, site visited Jul. 15, 2021. Available at URL: <https://www.amazon.in/Gshine-Reusable-Silicone-Airtight-Sandwich/dp/B07MK2TZ2R> (Year: 2020).\*  
(Continued)

*Primary Examiner* — Holly E Thurman  
*Assistant Examiner* — Altaira J Swangin

(56) **References Cited**

**U.S. PATENT DOCUMENTS**

D278,974 S \* 5/1985 Ray ..... D9/434  
4,718,778 A \* 1/1988 Ichikawa ..... B65D 75/5883  
383/100  
D319,780 S \* 9/1991 Laaki ..... D9/707  
D353,744 S \* 12/1994 Ferris ..... D7/629  
D399,708 S \* 10/1998 Grissom ..... D7/629  
D445,567 S \* 7/2001 Imbert ..... D3/246  
6,332,564 B2 \* 12/2001 Ichikawa ..... B65D 75/5883  
222/464.1  
D478,504 S \* 8/2003 Crozet ..... D9/708  
D582,788 S \* 12/2008 Smith ..... D9/708  
D586,232 S \* 2/2009 Friebe ..... D9/707  
D607,343 S \* 1/2010 Poirier ..... D9/707  
D658,948 S \* 5/2012 Zorovich ..... D7/629  
D692,280 S \* 10/2013 Aldridge ..... D7/629  
D695,133 S \* 12/2013 Teman ..... D9/709

(57) **CLAIM**

The ornamental design for a fresh-keeping bag, as shown and described.

**DESCRIPTION**

FIG. 1 is a top front perspective view of a fresh-keeping bag, showing my new design;  
FIG. 2 is a rear bottom perspective view thereof;  
FIG. 3 is a front elevational view thereof;  
FIG. 4 is a rear elevational view thereof;  
FIG. 5 is a left side elevational view thereof;  
FIG. 6 is a right side elevational view thereof;  
FIG. 7 is a top plan view thereof; and,  
FIG. 8 is a bottom plan view thereof.

**1 Claim, 8 Drawing Sheets**

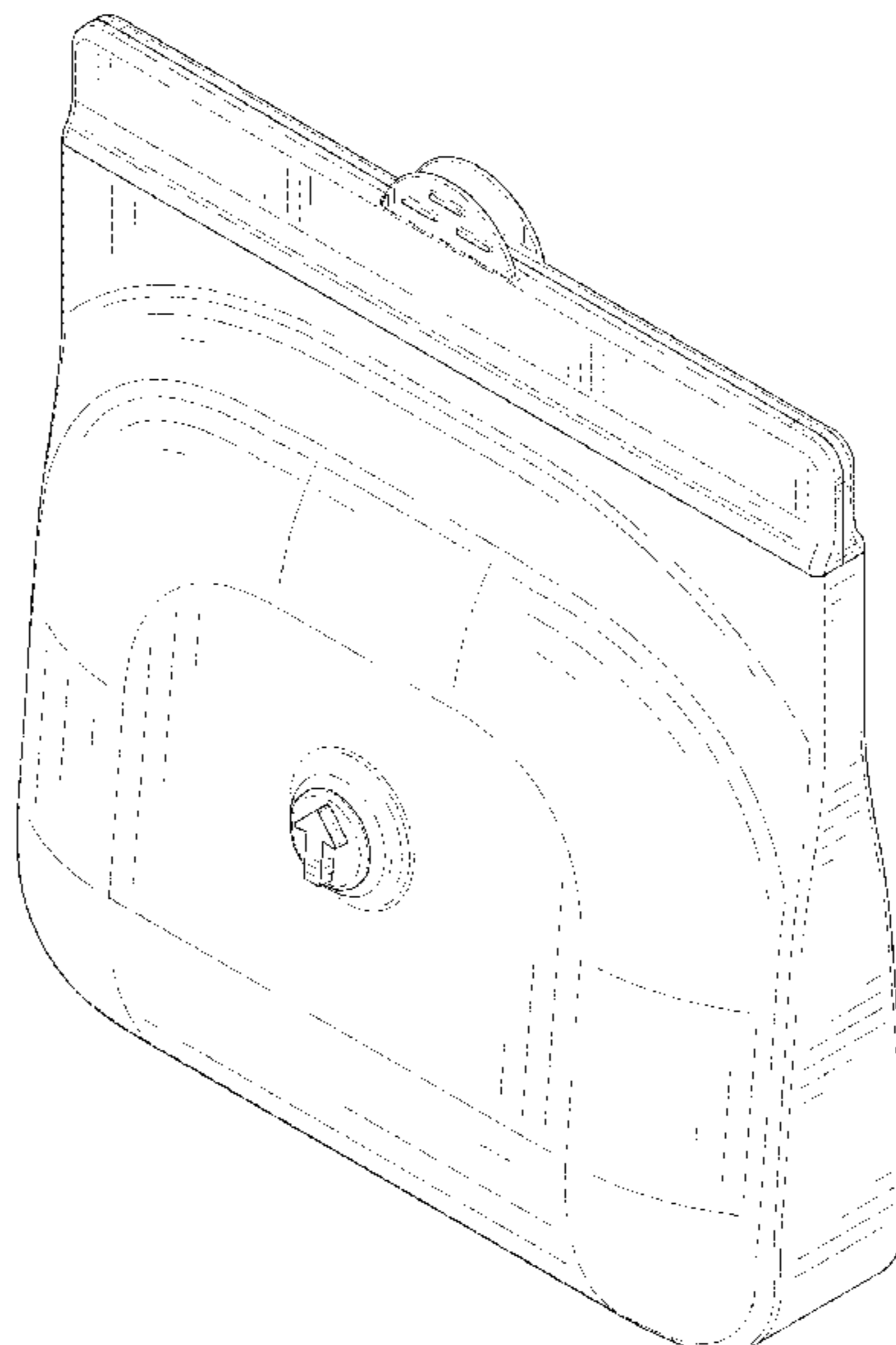

(56)

**References Cited**

U.S. PATENT DOCUMENTS

D772,565 S \* 11/2016 Gavriel ..... D3/243  
D779,972 S \* 2/2017 Yu ..... D9/709  
D874,294 S \* 2/2020 McGrath ..... D9/709  
D878,925 S \* 3/2020 McGrath ..... D9/709  
D878,926 S \* 3/2020 McGrath ..... D9/709  
D880,249 S \* 4/2020 Xu ..... D7/602  
D885,931 S \* 6/2020 Yosufy ..... D9/709  
D913,108 S \* 3/2021 Han ..... D9/707

FOREIGN PATENT DOCUMENTS

KR 300885165.0000 \* 12/2016  
KR 301047755.0000 \* 2/2020

OTHER PUBLICATIONS

Reusable Silicone Food Storage Bag, Mobisilicone, supplyleader.com, author and date unlisted © Supply Leader Group Limited, online, site visited Jul. 15, 2021. Available at URL: <https://supplyleader.com/product/MOBISILICONE-Reusable-Silicone-Food-Storage-Bags-2-Size-Bag-Set-44-oz-and-68-oz-Self-Seal-Platinum-Cured-Thick-Silicone-Bags-Leakproof-Seal-100-Pure-Food-Grade-Silicone-with-Freshness-Dial/B089WHKGKX> (Year: 2021).\*

\* cited by examiner

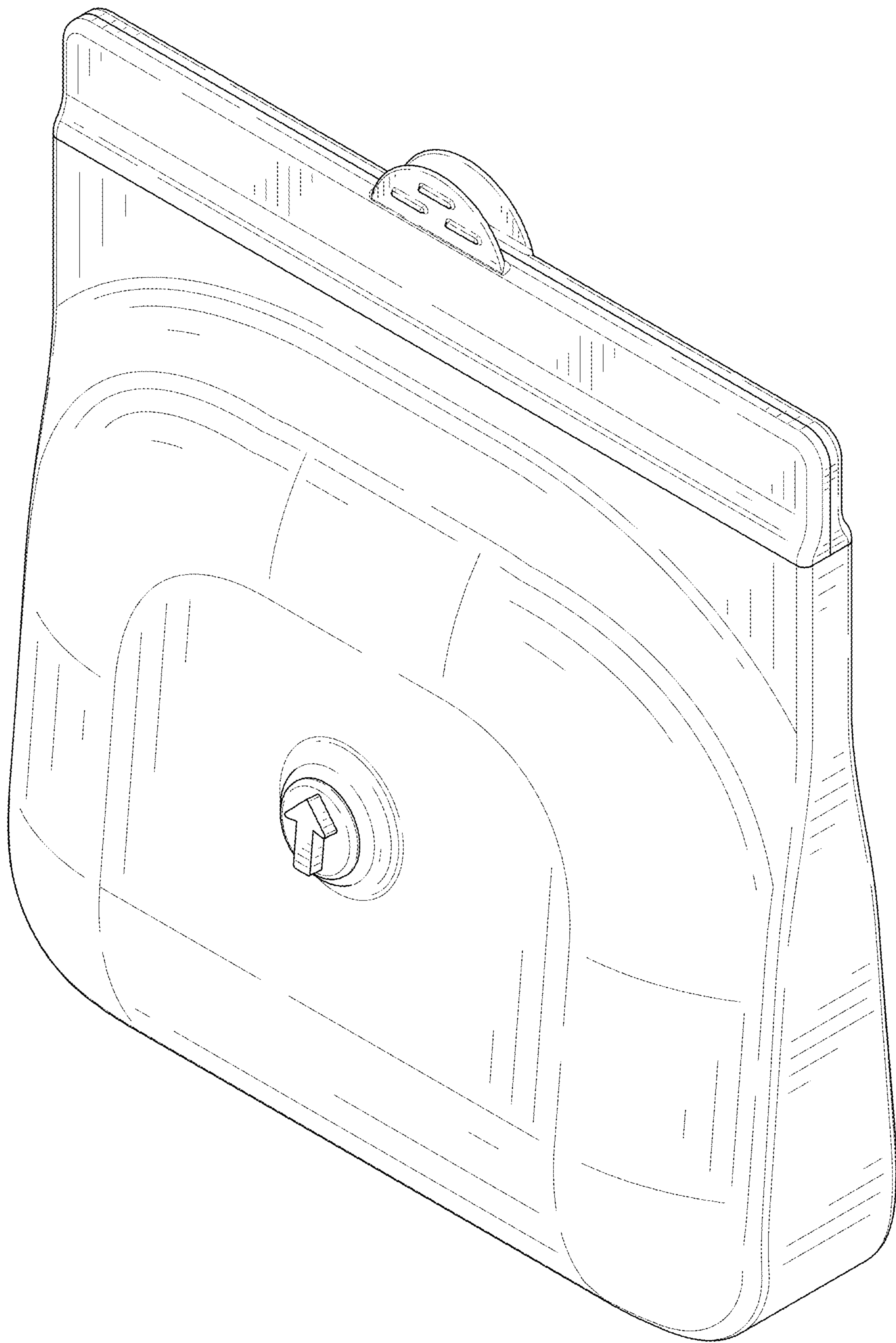

FIG. 1

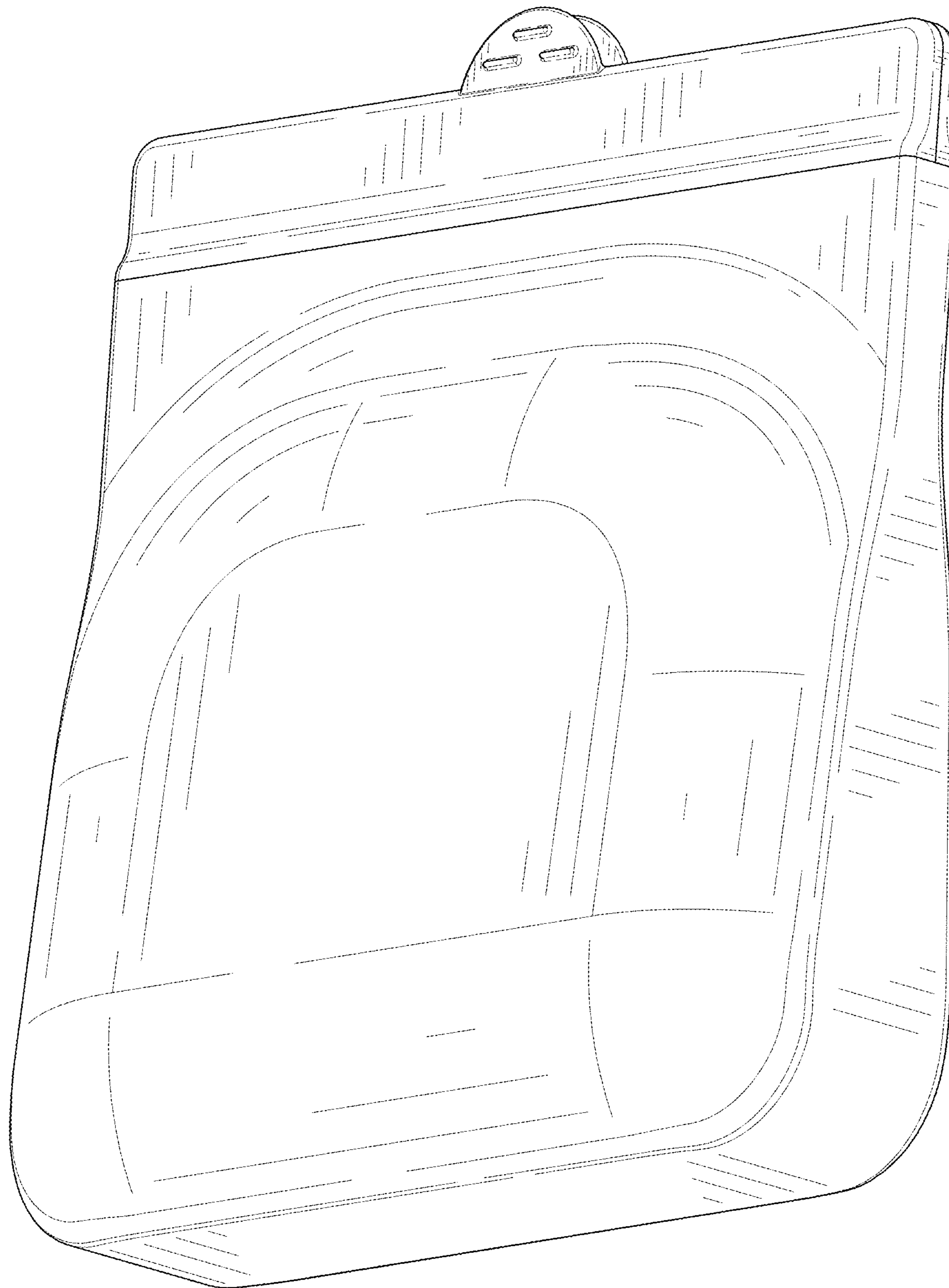

FIG. 2

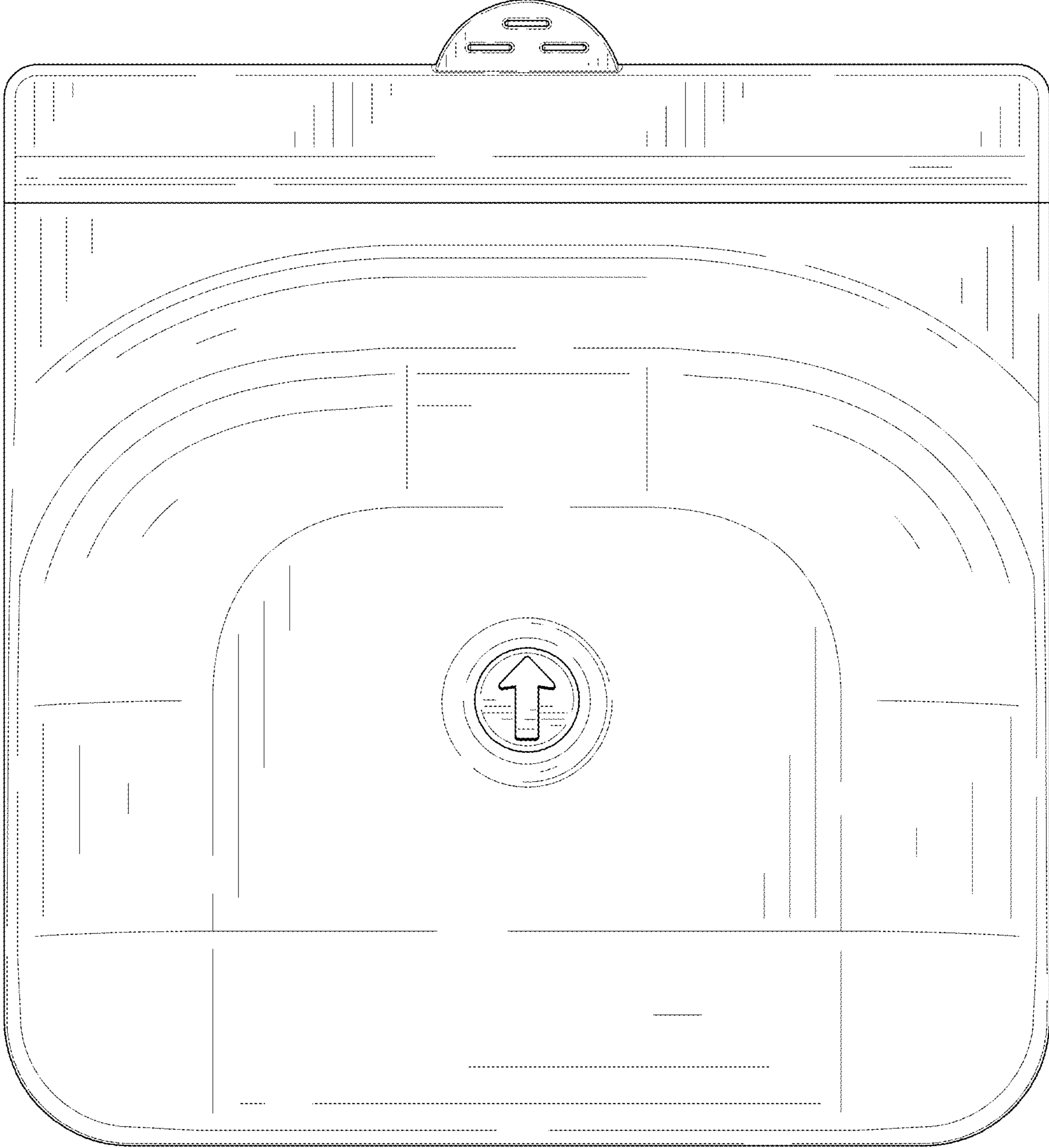

FIG. 3

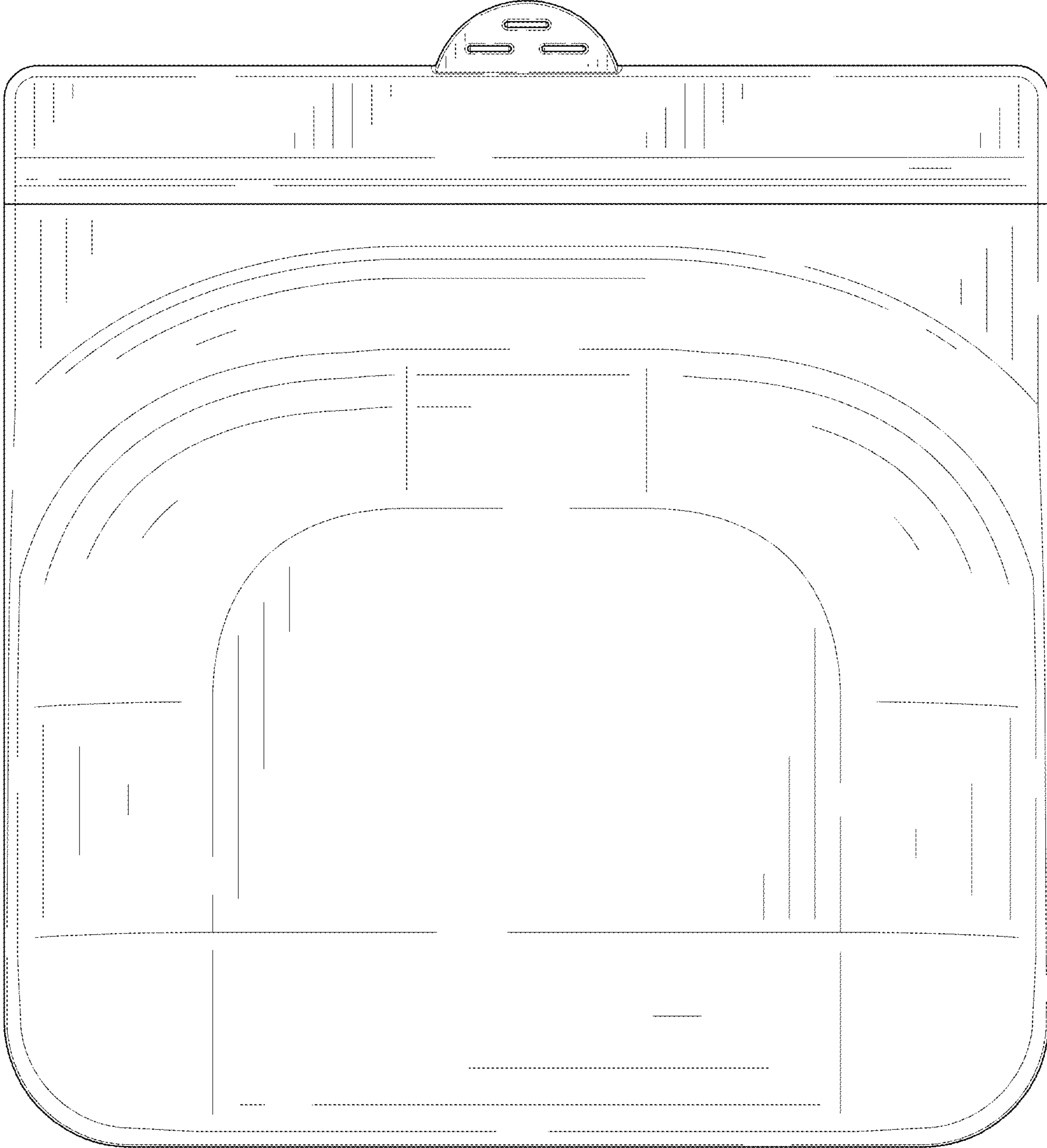

FIG. 4

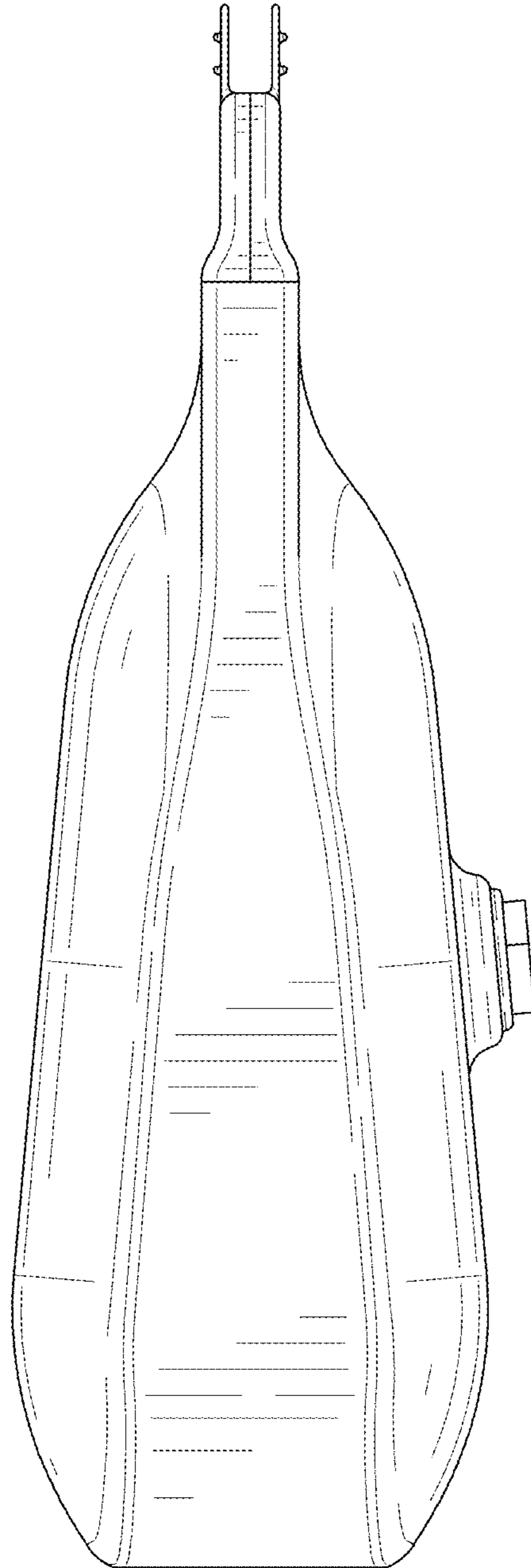

FIG. 5

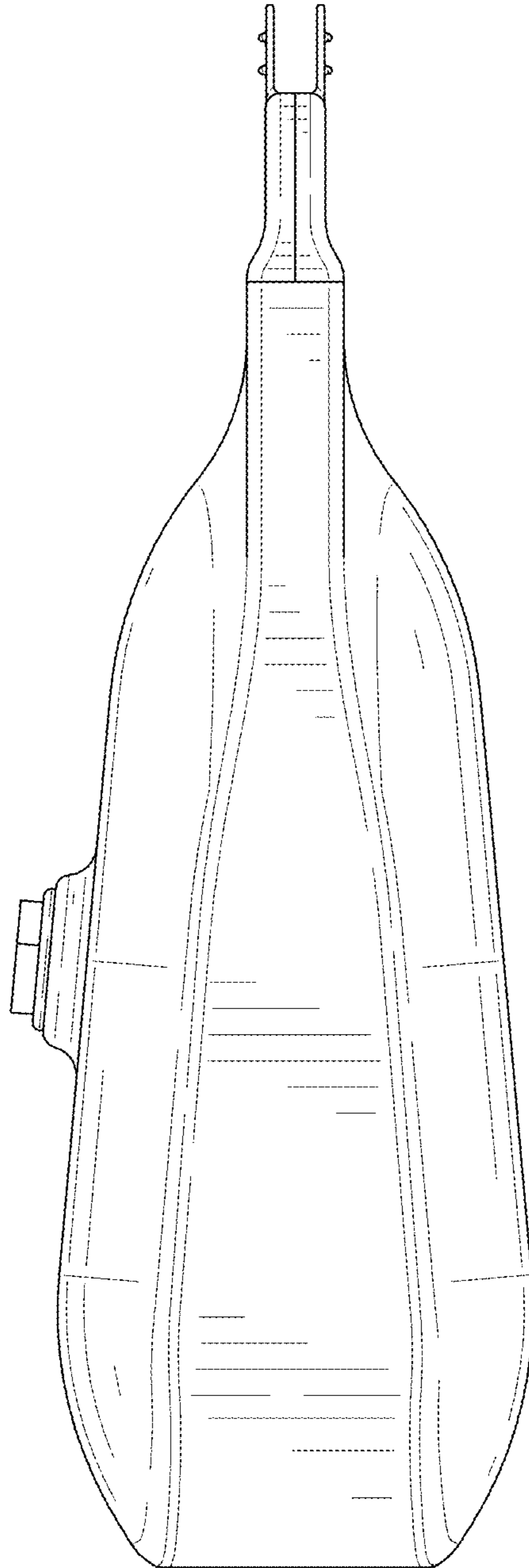

FIG. 6



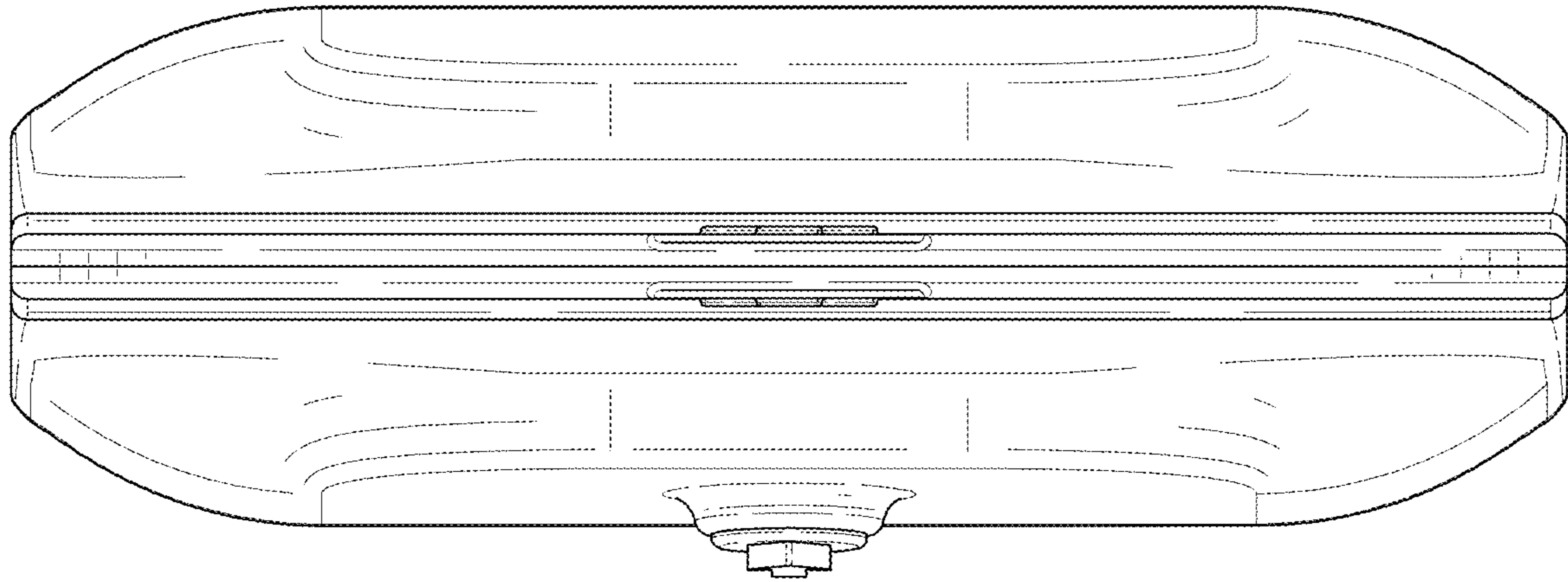

FIG. 7

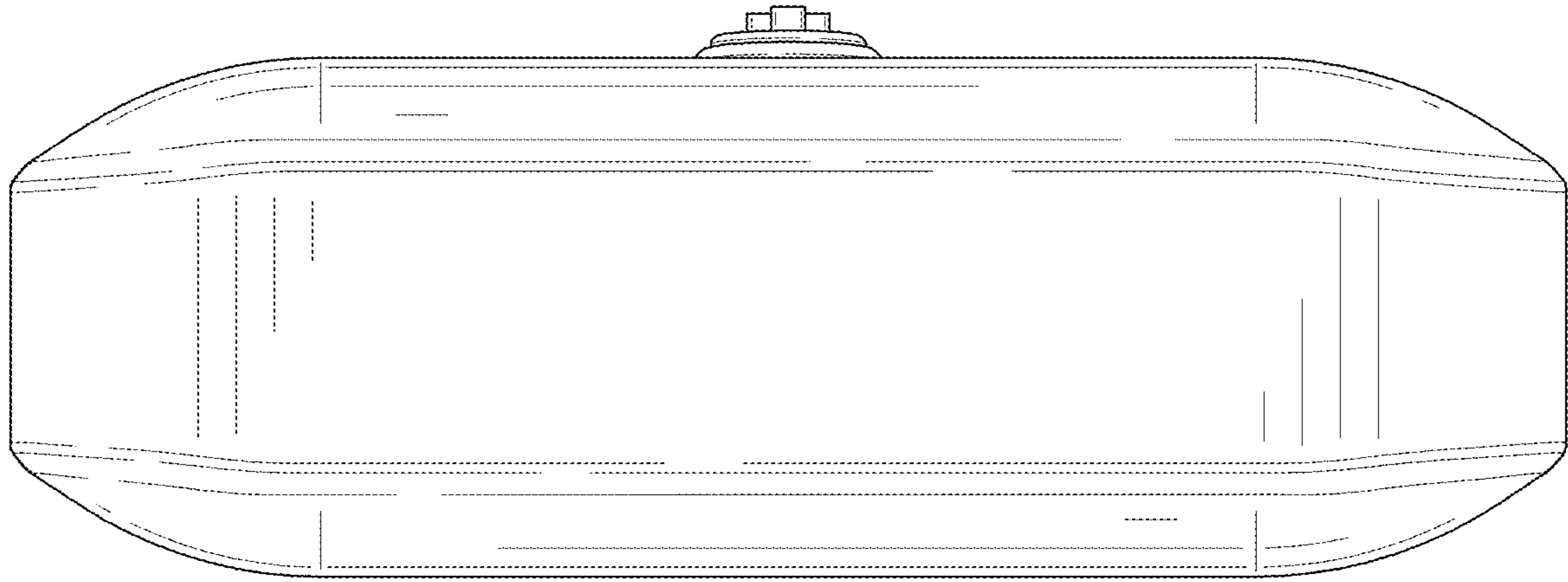

FIG. 8