



US00D940503S

(12) **United States Design Patent**
Guerin et al.

(10) **Patent No.:** **US D940,503 S**
(45) **Date of Patent:** **** Jan. 11, 2022**

(54) **COOKING BASKET**

- (71) Applicant: **SharkNinja Operating LLC**,
Needham, MA (US)
- (72) Inventors: **Thomas Guerin**, Boston, MA (US);
Chris Martin, Concord, MA (US);
Nathaniel R. Lavins, Somerville, MA
(US); **Da Deng**, Newton, MA (US)
- (73) Assignee: **Sharkninja Operating LLC**, Needham,
MA (US)
- (**) Term: **15 Years**
- (21) Appl. No.: **29/756,648**
- (22) Filed: **Oct. 29, 2020**

Related U.S. Application Data

- (60) Division of application No. 29/679,925, filed on Feb.
11, 2019, now Pat. No. Des. 903,415, which is a
(Continued)
- (51) **LOC (13) Cl.** **07-02**
- (52) **U.S. Cl.**
USPC **D7/409; D7/354**
- (58) **Field of Classification Search**
USPC **D7/323, 332, 335-337, 354-364,**
D7/387-388, 402-403, 407-409, 667, 415
(Continued)

(56) **References Cited**

U.S. PATENT DOCUMENTS

508,831 A 11/1893 Nicholls
1,272,222 A * 7/1918 clayton A47J 27/60
99/418

(Continued)

FOREIGN PATENT DOCUMENTS

CN 2253170 Y 4/1997
CN 1218653 A 6/1999

(Continued)

OTHER PUBLICATIONS

U.S. Appl. No. 29/653,847, filed Jun. 19, 2018; Restriction Require-
ment dated May 29, 2020; 7 pages.

(Continued)

Primary Examiner — Ricky Pham

(74) *Attorney, Agent, or Firm* — Mintz Levin Cohn Ferris
Glovsky and Popeo, PC; Lisa Adams

(57) **CLAIM**

The ornamental design for a cooking basket, as shown and
described.

DESCRIPTION

FIG. 1 is an upper perspective view of a cooking basket,
showing our new design;
FIG. 2 is a lower perspective view of the embodiment shown
in FIG. 1;
FIG. 3 is a front view of the embodiment shown in FIG. 1;
FIG. 4 is a rear view of the embodiment shown in FIG. 1;
FIG. 5 is a side view of the embodiment shown in FIG. 1;
FIG. 6 is another side view of the embodiment shown in
FIG. 1;
FIG. 7 is a top view of the embodiment shown in FIG. 1;
and,
FIG. 8 is a bottom view of the embodiment shown in FIG.
1.

The broken lines in the figures are for environmental pur-
poses only and form no part of the claimed design.

The dash dot lines represent boundary lines between claimed
and unclaimed subject matter.

1 Claim, 6 Drawing Sheets

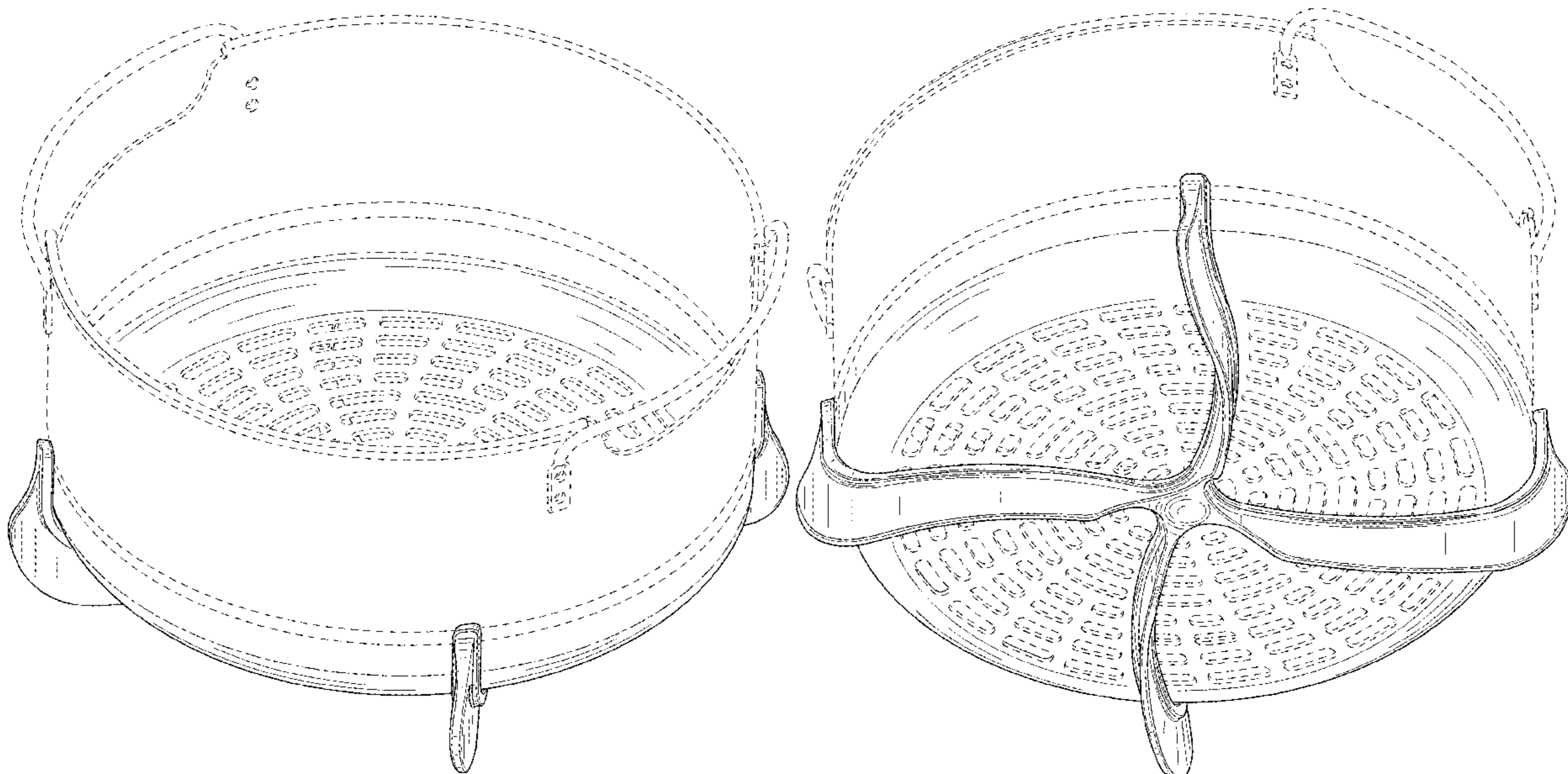

Related U.S. Application Data

continuation of application No. 29/659,576, filed on Aug. 9, 2018, now Pat. No. Des. 903,413.

(58) **Field of Classification Search**

CPC A21B 2/00; A21B 3/00; A21B 3/13; A21B 3/15; A21B 5/00; A21B 5/02; A23N 12/06; A23N 12/08; A23N 12/10; A47J 27/04; A47J 27/10; A47J 27/60; A47J 37/00; A47J 37/04; A47J 37/041; A47J 37/042; A47J 37/06; A47J 37/0688; A47J 37/0694; A47J 37/07; A47J 37/0704; A47J 37/10; A47J 37/1295; A47J 47/20; A47J 2037/00; A47J 2037/06; A47J 2037/0611; A47J 2037/07; A47J 2037/0786; A47J 2037/0795; A47J 27/00; A47J 27/08; A47J 27/09; A47J 27/092; A47J 36/025; A47J 36/06; A47J 36/08; A47J 36/10; A47J 36/12; A47J 36/18; A47J 36/20; A47J 36/22; A47J 36/165; A47J 37/01; A47J 37/079; A47J 37/12; A47J 37/129; A47J 37/1204; A47J 37/1209; A47J 37/1214; A47J 37/1219; A47J 37/1266; A47J 37/1285; F24C 15/10; F24C 15/12; F24C 15/14; F24C 15/16; F24C 15/18; F24C 15/164; A01K 97/01; A23L 1/01; A23L 1/0107; A23L 1/0114; F26B 9/003; G07F 17/0064; G07F 17/0078; G07F 17/0085; H05B 6/02; H05B 6/06; H05B 6/12

See application file for complete search history.

(56) **References Cited**

U.S. PATENT DOCUMENTS

1,272,722 A 7/1918 Clayton
 D91,011 S * 11/1933 Crisenberry D23/415
 1,986,088 A 1/1935 Wild
 1,994,268 A 3/1935 Bartels
 2,055,972 A 9/1936 Fritsche
 D105,670 S 8/1937 Nelson
 2,313,968 A 10/1937 Reich
 2,378,950 A 10/1937 Reich
 2,188,757 A 8/1938 Moon
 2,253,833 A 12/1939 Volks
 D119,039 S * 2/1940 Hennessy D7/408
 D157,480 S * 2/1950 Foss D7/388
 2,785,277 A 3/1957 Jepson
 3,076,405 A 2/1963 Lang
 3,122,134 A 2/1964 Reeves
 3,514,301 A 5/1970 Berger
 3,529,582 A 9/1970 Hurko et al.
 3,610,885 A 10/1971 Zingg
 3,821,454 A 6/1974 Lobel
 3,828,760 A 8/1974 Farber et al.
 4,106,486 A 8/1978 Lee
 D249,924 S 10/1978 Fischer
 D251,107 S * 2/1979 Ottier D7/409
 4,148,250 A 4/1979 Miki et al.
 4,162,741 A 7/1979 Walker et al.
 D255,751 S 7/1980 Daenen
 4,210,072 A 7/1980 Pedrini
 4,241,288 A 12/1980 Aoshima et al.
 4,268,741 A 5/1981 O'Brien
 4,374,318 A 2/1983 Gilliom
 4,484,063 A 11/1984 Whittenburg et al.
 4,509,412 A 4/1985 Whittenburg et al.
 4,591,698 A 5/1986 Chang
 4,728,762 A 3/1988 Roth et al.
 D296,643 S 7/1988 Mueller
 4,771,162 A 9/1988 Schatz
 D300,108 S 3/1989 Iwahashi

4,848,217 A 7/1989 Koziol
 4,889,972 A 12/1989 Chang
 4,913,126 A * 4/1990 McCall A01K 97/01
 126/204
 D309,078 S 7/1990 Kokubo
 5,000,085 A 3/1991 Archer
 D316,007 S 4/1991 Wagner
 5,008,508 A 4/1991 Skerker et al.
 5,012,071 A 4/1991 Henke
 5,029,519 A 7/1991 Boyen
 5,031,519 A 7/1991 Toida et al.
 5,036,179 A 7/1991 Westerberg et al.
 5,048,400 A 9/1991 Ueda et al.
 5,092,229 A 3/1992 Chen
 5,097,753 A 3/1992 Naft
 5,105,725 A 4/1992 Haglund
 D328,549 S 8/1992 Skerker et al.
 5,195,424 A * 3/1993 Guajaca A47J 27/04
 126/348
 5,205,274 A 4/1993 Smith et al.
 5,211,105 A * 5/1993 Liu A47J 37/01
 126/348
 D338,132 S 8/1993 Chang
 D339,266 S * 9/1993 Lockett D7/323
 5,251,542 A 10/1993 Itoh
 5,355,777 A 10/1994 Chen et al.
 5,416,950 A 5/1995 Dornbush et al.
 5,445,061 A 8/1995 Barradas
 5,458,054 A 10/1995 Yu
 5,485,780 A 1/1996 Koether et al.
 5,513,558 A 5/1996 Erickson et al.
 5,526,374 A 6/1996 Harrison
 5,526,734 A 6/1996 Harrison
 5,549,039 A 8/1996 Ito et al.
 5,567,458 A 10/1996 Wu
 5,588,352 A 12/1996 Harrison
 5,590,583 A 1/1997 Harrison
 D378,565 S * 3/1997 Cousins D7/667
 D378,566 S * 3/1997 Cousins D7/667
 5,615,607 A 4/1997 Delaquis et al.
 5,619,983 A 4/1997 Smith
 5,632,403 A 5/1997 Deng
 D380,504 S 7/1997 Yang
 5,649,476 A 7/1997 Montagnino et al.
 5,676,044 A 10/1997 Lara, Jr.
 5,699,722 A 12/1997 Erickson et al.
 5,740,721 A 4/1998 Bizard et al.
 5,768,976 A 6/1998 Suk
 D397,261 S 8/1998 Sellers
 5,839,357 A 11/1998 Ha et al.
 5,865,104 A 2/1999 Sham et al.
 5,896,808 A 4/1999 Graur
 5,932,130 A 8/1999 Taino
 5,957,038 A 9/1999 Shimazaki
 5,967,021 A 10/1999 Yung
 6,006,939 A 12/1999 Wai
 6,014,986 A 1/2000 Baumgarten
 6,019,029 A 2/2000 Chan
 6,023,050 A 2/2000 Violi
 6,060,698 A 5/2000 Petrides et al.
 6,066,837 A 5/2000 McCormick et al.
 6,067,896 A 5/2000 Elorza
 6,070,518 A 6/2000 Kao
 6,082,249 A 7/2000 Su
 6,083,543 A 7/2000 Kim et al.
 6,097,016 A 8/2000 Hirata et al.
 6,103,291 A 8/2000 Fernandez Tapia
 6,104,004 A 8/2000 Ragland et al.
 6,105,808 A 8/2000 Mendonca
 D430,776 S 9/2000 Pai
 6,116,151 A 9/2000 Fickert et al.
 6,125,737 A 10/2000 Chang
 6,135,012 A 10/2000 Kao
 6,135,013 A 10/2000 Barrena
 6,158,606 A 12/2000 Oliver
 6,173,643 B1 1/2001 Qian et al.
 6,178,876 B1 1/2001 Kao
 6,191,393 B1 2/2001 Park
 6,201,217 B1 3/2001 Moon et al.

(56)

References Cited

U.S. PATENT DOCUMENTS

6,242,025 B1	6/2001	Lesky et al.	6,903,310 B1	6/2005	Lee
6,252,206 B1	6/2001	Leukhardt, III et al.	6,917,017 B2	7/2005	Moon et al.
6,255,630 B1	7/2001	Barnes et al.	6,933,477 B2	8/2005	Becker et al.
6,257,124 B1	7/2001	Chen	6,935,223 B2	8/2005	Kobayashi
6,262,396 B1	7/2001	Witt et al.	6,936,795 B1	8/2005	Moon et al.
6,267,046 B1	7/2001	Wanat	6,936,801 B1	8/2005	Head
6,268,592 B1	7/2001	Hu et al.	6,941,857 B2	9/2005	McLemore
6,269,737 B1	8/2001	Rigney et al.	D514,383 S	2/2006	Vetter
6,271,504 B1	8/2001	Barritt	7,009,147 B1	3/2006	Schulte
6,283,014 B1	9/2001	Ng et al.	7,012,220 B2	3/2006	Boyer et al.
6,283,015 B1	9/2001	Kwon et al.	7,012,221 B2	3/2006	Li
6,320,166 B1	11/2001	Park	7,021,203 B2	4/2006	Backus et al.
6,355,914 B1	3/2002	Stockley	7,021,204 B2	4/2006	Backus et al.
6,384,381 B2	5/2002	Witt et al.	7,053,337 B2	5/2006	Ragan et al.
D458,078 S	6/2002	Lin	7,060,943 B2	6/2006	Hwang
6,399,925 B1	6/2002	Pickering et al.	7,081,601 B2	7/2006	Boyer et al.
6,414,254 B1	7/2002	McNair	7,082,871 B2	8/2006	Schultz
6,425,320 B1	7/2002	Chameroy et al.	7,086,326 B2	8/2006	Yokoyama
6,443,053 B1	9/2002	Rossi	7,126,088 B2	10/2006	Horton et al.
6,450,085 B1	9/2002	Riesselman	D532,644 S	11/2006	Ball
6,450,361 B1	9/2002	Mendelson et al.	7,148,451 B2	12/2006	Miyake et al.
6,454,225 B1	9/2002	Jaworski	7,154,069 B1	12/2006	Gordon
6,455,085 B1	9/2002	Duta	7,156,087 B1	1/2007	Churchill et al.
D464,233 S	10/2002	Pai	7,157,675 B2	1/2007	Imura
6,467,645 B2	10/2002	Park	7,166,822 B1	1/2007	Chang et al.
6,486,453 B1	11/2002	Bales et al.	D549,517 S	8/2007	Moran
6,494,337 B1	12/2002	Moroni	7,276,677 B1	10/2007	Shelton
6,509,550 B1	1/2003	Li	7,285,751 B2	10/2007	Li et al.
6,513,420 B1	2/2003	Park	D555,777 S	11/2007	Aveldson et al.
6,523,459 B1	2/2003	Chameroy et al.	7,322,279 B2	1/2008	Cartigny et al.
6,528,772 B1	3/2003	Graves et al.	7,322,280 B2	1/2008	Seurat Guiochet et al.
6,540,097 B1	4/2003	Beck et al.	7,325,481 B2	2/2008	Helm
6,545,252 B2	4/2003	Wang	7,368,688 B2	5/2008	Kim et al.
6,552,309 B1	4/2003	Kish et al.	7,373,874 B2	5/2008	Seurat Guiochet et al.
6,559,427 B1	5/2003	Barnes et al.	7,377,208 B2	5/2008	Ho et al.
6,565,903 B2	5/2003	Ng et al.	D573,466 S	7/2008	White et al.
6,573,483 B1	6/2003	Decobert et al.	7,411,159 B2	8/2008	Oosterling
6,604,453 B2	8/2003	Niese	7,412,922 B2	8/2008	McLemore
6,615,706 B1	9/2003	Wu	D581,200 S	11/2008	Lee
6,615,708 B1	9/2003	Lin	D581,201 S	11/2008	Lee
6,631,824 B2	10/2003	Park	7,451,691 B2	11/2008	Robertson
6,669,047 B2	10/2003	Wooderson et al.	7,451,692 B2	11/2008	Baraille et al.
6,648,162 B1	11/2003	Wooderson et al.	7,468,495 B2	12/2008	Carbone et al.
6,617,554 B2	12/2003	Moon et al.	7,523,696 B2	4/2009	Seurat Guiochet et al.
6,657,167 B2	12/2003	Loveless	D592,445 S	5/2009	Sorenson et al.
6,695,319 B1	2/2004	Anota et al.	7,530,302 B2	5/2009	Stephanou
D487,212 S	3/2004	Park	7,565,862 B2	7/2009	Cartigny et al.
6,698,337 B1	3/2004	Park	D602,283 S	10/2009	Glenn
6,705,209 B2	3/2004	Yang et al.	7,605,349 B2	10/2009	Gaynor et al.
6,723,963 B2	4/2004	Ronda	D604,098 S	11/2009	Hamlin
6,730,881 B1	5/2004	Arntz et al.	7,619,186 B2	11/2009	Cavada et al.
6,730,882 B2	5/2004	Atkinson	D606,799 S	12/2009	Saunders
6,730,889 B1	5/2004	Jones-Lawlor	7,624,674 B2	12/2009	Chameroy et al.
6,732,636 B1	5/2004	Germano	7,637,206 B2	12/2009	Seurat Guiochet et al.
6,736,131 B2	5/2004	Yamamoto et al.	7,669,521 B2	3/2010	Cartigny et al.
6,740,855 B1	5/2004	Decobert et al.	D613,131 S	4/2010	Chen et al.
6,742,445 B2	6/2004	Backus et al.	7,703,385 B2	4/2010	Seurat Guiochet et al.
6,747,250 B1	6/2004	Cha	D616,246 S	5/2010	Filho et al.
6,755,319 B2	6/2004	Park	7,718,928 B2	5/2010	He et al.
6,758,132 B1	7/2004	Kuo et al.	D616,731 S	6/2010	Hart
6,777,651 B1	8/2004	Boyer	7,726,508 B2	6/2010	Hasegawa
6,782,805 B2	8/2004	Backus et al.	7,762,420 B2	7/2010	Auwarter et al.
6,782,806 B2	8/2004	Backus et al.	D622,100 S	8/2010	Carlini
6,802,429 B1	10/2004	Wildman	7,766,003 B2	8/2010	Kim
6,809,297 B2	10/2004	Moon et al.	7,775,390 B2	8/2010	de Bastos Reis Portugal et al.
6,812,433 B1	11/2004	Barritt	7,800,022 B2	9/2010	Kim
6,815,644 B1	11/2004	Muegge et al.	7,838,799 B2	11/2010	Freedman
6,831,254 B2	12/2004	Barritt	7,875,836 B2	1/2011	Imura et al.
6,837,150 B2	1/2005	Backus et al.	D632,129 S	2/2011	Chen
6,841,762 B2	1/2005	Suzuki	D637,861 S	5/2011	Degnan
6,845,707 B1	1/2005	Xu et al.	7,935,914 B2	5/2011	Imura
6,851,351 B2	2/2005	Payen et al.	7,964,824 B2	6/2011	Moon
6,872,921 B1	3/2005	DeCobert et al.	7,968,824 B2	6/2011	Lee et al.
6,874,408 B2	4/2005	Backus et al.	D640,896 S	7/2011	Molayem
6,877,633 B2	4/2005	Niese	8,006,685 B2	8/2011	Bolton et al.
			D645,703 S	9/2011	Sadtler
			8,011,293 B2	9/2011	McFadden et al.
			D646,525 S	10/2011	Molayem
			D651,456 S	1/2012	Moon et al.

(56)

References Cited

U.S. PATENT DOCUMENTS

8,096,436 B2	1/2012	Rhetat et al.	9,057,526 B2	6/2015	Barritt	
8,096,440 B2	1/2012	Rhetat et al.	D734,094 S *	7/2015	Vogds	D7/409
D658,949 S	5/2012	Tsui	D735,520 S	8/2015	Mandil	
8,205,543 B2	6/2012	Rhetat et al.	D737,623 S	9/2015	Hu et al.	
8,247,751 B2	8/2012	Jagannathan	D738,676 S	9/2015	Accoceberry	
D667,255 S	9/2012	Reiner	9,119,501 B2	9/2015	Xie	
8,258,435 B2	9/2012	Bonuso et al.	9,125,513 B2	9/2015	Kim	
D668,109 S	10/2012	Börjesson	9,138,106 B2	9/2015	Walker	
D669,730 S	10/2012	Mandil	D743,201 S	11/2015	Aderka	
8,276,507 B1	10/2012	Walker	9,177,460 B2	11/2015	Fissler	
8,286,548 B2	10/2012	Krishnan et al.	9,191,998 B2	11/2015	Hegedis et al.	
8,299,404 B2	10/2012	Van Der Weij	9,220,362 B2	12/2015	Eades et al.	
D671,354 S	11/2012	Ou et al.	9,237,829 B2	1/2016	Alet Vidal et al.	
8,302,800 B2	11/2012	Hasegawa	D749,906 S	2/2016	Lee	
8,304,695 B2	11/2012	Bonuso et al.	D750,421 S	3/2016	Ho	
D671,803 S *	12/2012	Myoung	9,271,595 B2	3/2016	Lee	
8,330,083 B2	12/2012	Moon et al.	9,295,354 B2	3/2016	Sloot et al.	
8,338,757 B2	12/2012	Isoda et al.	D754,469 S	4/2016	Deters	
8,378,265 B2	2/2013	Greenwood et al.	D754,494 S *	4/2016	Schuler	D7/667
8,381,712 B1	2/2013	Simms, II	9,301,644 B2	4/2016	Payen et al.	
D677,515 S	3/2013	Cloutier	9,314,134 B2	4/2016	Molnar	
8,393,262 B1	3/2013	Molayem	9,320,381 B2	4/2016	Chameroy et al.	
8,461,488 B2	6/2013	Jeong et al.	9,339,145 B1	5/2016	Owczarzak	
D686,452 S	7/2013	Nordwall	9,341,382 B2	5/2016	Kim	
8,517,205 B2	8/2013	Thelen	9,351,495 B2	5/2016	McFadden	
8,544,381 B2	10/2013	Cartigny et al.	9,353,954 B2	5/2016	Linnewiel	
8,546,731 B2	10/2013	Pellerin et al.	9,414,713 B2	8/2016	Jinzhao	
8,561,525 B2	10/2013	Bauchot et al.	9,433,036 B2	8/2016	Kurtimoto et al.	
D693,643 S	11/2013	Moon et al.	9,439,530 B2	9/2016	Logan et al.	
8,578,293 B2	11/2013	Breunig et al.	D769,058 S	10/2016	Lee	
8,581,137 B2	11/2013	Egenter	9,456,713 B2	10/2016	Backaert et al.	
8,618,447 B2	12/2013	De'Longhi	9,470,423 B2	10/2016	Jacob et al.	
8,637,797 B2	1/2014	Imura	9,474,412 B2	10/2016	Fung et al.	
D699,514 S	2/2014	Lovley, II et al.	D770,221 S	11/2016	Lee	
8,640,908 B2	2/2014	Yang et al.	D771,997 S *	11/2016	Affatato	D7/354
8,674,270 B2	3/2014	Anderson et al.	D772,648 S	11/2016	Palermo	
8,689,680 B2	4/2014	Park	9,480,364 B2	11/2016	McKee et al.	
8,709,905 B2	4/2014	Crayfourd	D774,350 S	12/2016	Mandil	
D703,993 S	5/2014	Garman	D774,356 S	12/2016	Maiorana et al.	
8,714,391 B2	5/2014	Milanesi	9,526,367 B2	12/2016	Anota et al.	
8,726,792 B2	5/2014	Shealy et al.	9,585,509 B2	3/2017	Wassmus et al.	
8,733,574 B2	5/2014	Heidrich et al.	9,596,954 B2	3/2017	Park	
D707,078 S *	6/2014	Rivera	D784,076 S	4/2017	Constantieux	
8,739,690 B2	6/2014	Chameroy et al.	9,615,691 B2	4/2017	Xiao	
8,747,933 B1	6/2014	McGinn	9,615,692 B2	4/2017	Hoffmann et al.	
8,766,144 B2	7/2014	McLoughlin et al.	9,615,694 B2	4/2017	Yoshidome	
8,777,038 B2	7/2014	Wen	9,629,499 B2	4/2017	Kim	
8,783,498 B2	7/2014	Li	9,629,500 B2	4/2017	Chance	
8,783,947 B2	7/2014	Ferron et al.	D786,630 S	5/2017	Walsh et al.	
D710,647 S	8/2014	Mandil et al.	9,636,618 B2	5/2017	Fung et al.	
8,800,803 B2	8/2014	Stellwag	9,642,487 B1	5/2017	McGinn	
8,808,772 B2	8/2014	Lubrina et al.	9,648,975 B2	5/2017	Imura	
8,813,989 B2	8/2014	Hoffmann et al.	9,648,985 B2	5/2017	Huang et al.	
8,820,220 B2	9/2014	Thelen et al.	9,681,770 B2	6/2017	Backaert et al.	
8,847,129 B2	9/2014	Kim et al.	9,681,773 B2	6/2017	McKee et al.	
8,869,829 B2	10/2014	Hasegawa	9,706,871 B2	7/2017	Matthijs	
8,887,939 B2	11/2014	Chameroy et al.	9,717,364 B2	8/2017	Sladeczek	
D719,398 S	12/2014	Deters	9,737,936 B2	8/2017	Linglin et al.	
D720,571 S	1/2015	Deters	9,750,089 B2	8/2017	Wiedemann et al.	
8,931,402 B2	1/2015	Chameroy et al.	D797,492 S	9/2017	Shieh	
8,931,659 B2	1/2015	Rhetat et al.	9,756,980 B1	9/2017	Li et al.	
8,944,272 B2	2/2015	Chameroy et al.	9,763,531 B2	9/2017	Baraille et al.	
8,944,273 B2	2/2015	Chameroy et al.	D801,106 S	10/2017	Mirchandani et al.	
8,955,426 B2 *	2/2015	Glynn	9,775,461 B2	10/2017	Yang et al.	
		A47J 27/04	9,795,250 B2	10/2017	Huang	
		99/450	9,801,491 B2	10/2017	Cohade et al.	
D723,323 S	3/2015	Carlson	D802,987 S	11/2017	Corlay	
8,973,770 B2	3/2015	He et al.	9,808,119 B1	11/2017	Hough	
8,985,372 B2	3/2015	Yang et al.	9,814,355 B2	11/2017	Winter et al.	
8,991,307 B2	3/2015	Grozinger et al.	9,841,261 B2	12/2017	Raghavan et al.	
D727,095 S	4/2015	Bak	9,854,932 B2	1/2018	Tiruvallur	
9,018,566 B2	4/2015	Wang	9,854,941 B2	1/2018	Bonaccorso	
D728,301 S	5/2015	Hack	9,861,231 B2	1/2018	Kim	
9,027,468 B2	5/2015	Rhetat et al.	9,867,234 B2	1/2018	Thomann et al.	
9,035,223 B2	5/2015	Noguchi et al.	9,872,582 B2	1/2018	Song et al.	
9,055,618 B2	6/2015	Bunzel et al.	9,877,610 B2	1/2018	Bucher et al.	
			D809,340 S	2/2018	Poon	
			9,883,768 B2	2/2018	Starflinger	
			9,888,811 B2	2/2018	Zwanenburg et al.	

(56)

References Cited

U.S. PATENT DOCUMENTS

9,895,028 B2	2/2018	Gerard et al.	2007/0199557 A1	8/2007	Von Kaenel, Jr.
9,900,936 B2	2/2018	Imm et al.	2007/0295221 A1	12/2007	Seurat Guiochet et al.
9,909,764 B2	3/2018	Bach	2008/0022861 A1	1/2008	Ferron
9,924,830 B1	3/2018	Glucksman et al.	2008/0078371 A1	4/2008	Boscaino
D814,232 S	4/2018	Barquin et al.	2008/0078755 A1	4/2008	Jeon et al.
D815,491 S	4/2018	Hollinger	2008/0083730 A1	4/2008	Dolgov et al.
9,930,990 B1	4/2018	Gupta et al.	2008/0095905 A1	4/2008	Sells et al.
D817,658 S	5/2018	Cute	2008/0099008 A1	5/2008	Bolton et al.
D817,697 S	5/2018	Zhao	2008/0105137 A1	5/2008	Genslak et al.
9,961,721 B2	5/2018	Guillemot et al.	2008/0142498 A1	6/2008	He et al.
9,962,029 B2	5/2018	Baraille et al.	2008/0163764 A1	7/2008	Payen et al.
9,980,605 B2	5/2018	De Haas et al.	2008/0206420 A1	8/2008	McFadden
D821,140 S	6/2018	Mirchandani et al.	2008/0213447 A1	9/2008	Payen et al.
D821,805 S	7/2018	Lee	2008/0216671 A1	9/2008	Chen
10,016,085 B2	7/2018	Sapire	2008/0223224 A1	9/2008	Martin
10,021,889 B2	7/2018	Vinett	2008/0290090 A1	11/2008	Kindler et al.
10,034,578 B2	7/2018	Ahmed	2008/0314258 A1	12/2008	Martin
D824,717 S	8/2018	Allen	2009/0011101 A1	1/2009	Doherty et al.
D826,638 S	8/2018	Zhang	2009/0013988 A1	1/2009	Kim et al.
10,045,651 B2	8/2018	Huang	2009/0064868 A1	3/2009	Cartossi
10,051,986 B2	8/2018	Schultz et al.	2009/0095166 A1	4/2009	Jian
10,051,995 B2	8/2018	Buckley et al.	2009/0134140 A1	5/2009	Vern Der Weij
10,057,946 B2	8/2018	Mills et al.	2009/0223380 A1	9/2009	Van Aken
10,058,210 B2	8/2018	Palermo	2009/0223386 A1	9/2009	Edwards
10,060,632 B2	8/2018	Lim et al.	2009/0250452 A1	10/2009	Tse
10,064,518 B2	9/2018	Xiao et al.	2010/0089248 A1	4/2010	Jones
10,076,206 B2	9/2018	Chameroy et al.	2010/0136194 A1	6/2010	Schutte
D832,023 S	10/2018	Barberi et al.	2010/0147159 A1	6/2010	Fossati
D832,030 S	10/2018	Veldeman	2010/0147824 A1	6/2010	Bonuso et al.
10,088,371 B2	10/2018	Kaiser et al.	2010/0206289 A1	8/2010	Larsen et al.
D833,204 S	11/2018	Lee	2010/0282097 A1	11/2010	Schulte
10,117,546 B2	11/2018	Le Grand	2011/0003048 A1	1/2011	Sugimoto et al.
10,123,656 B2	11/2018	Shanmugam	2011/0095015 A1	4/2011	Kao
10,130,205 B2	11/2018	Fung et al.	2011/0168158 A1	4/2011	Barkhouse
D834,889 S	12/2018	Moon et al.	2011/0120319 A1	5/2011	Chang
10,154,750 B2	12/2018	Allemand et al.	2011/0126719 A1	6/2011	Valance
D838,535 S	1/2019	Garman	2011/0146653 A1	6/2011	Kitatani
D838,548 S	1/2019	Schutte	2011/0147376 A1	6/2011	Ueda et al.
D841,396 S	2/2019	Prithviraj et al.	2011/0168033 A1	7/2011	Lee
D842,649 S	3/2019	Mishan	2011/0248020 A1	10/2011	Yuan
10,231,565 B2	3/2019	Song et al.	2011/0268153 A1	11/2011	He et al.
D845,072 S	4/2019	Colston et al.	2012/0003364 A1	1/2012	Kling et al.
D846,335 S	4/2019	Yang et al.	2012/0009317 A1	1/2012	McLemore
10,244,883 B2	4/2019	Chameroy et al.	2012/0012584 A1	1/2012	Chameroy et al.
D850,200 S	6/2019	Jiang	2012/0024164 A1	2/2012	Park et al.
D865,445 S *	11/2019	Lin D7/409	2012/0024169 A1	2/2012	Hsu
D869,903 S *	12/2019	Zhong D7/409	2012/0040067 A1	2/2012	Baraille et al.
D884,422 S *	5/2020	Zhong D7/409	2012/0048843 A1	3/2012	Feng et al.
D891,178 S *	7/2020	Lu D7/409	2012/0125313 A1	5/2012	Van Der Weij
D894,677 S *	9/2020	Tran D7/403	2012/0174797 A1	7/2012	Froza
10,806,299 B2 *	10/2020	Yan F24B 1/022	2012/0181363 A1	7/2012	Huang
D903,413 S *	12/2020	Guerin D7/409	2012/0192726 A1	8/2012	Clearman et al.
D903,414 S *	12/2020	Guerin D7/409	2012/0217236 A1	8/2012	Takagi
D903,415 S *	12/2020	Guerin D7/409	2012/0217252 A1	8/2012	Jung
D914,447 S *	3/2021	Gill D7/407	2012/0222665 A1	9/2012	Ahmed
D918,655 S *	5/2021	Lin D7/409	2012/0318149 A1	12/2012	Ahmed
2002/0179587 A1	12/2002	Hui	2013/0019759 A1	1/2013	Tumenbatur et al.
2002/0185012 A1	12/2002	Yokoyama	2013/0074702 A1	3/2013	DiFante
2003/0034027 A1	2/2003	Yamamoto et al.	2013/0092145 A1	4/2013	Murphy et al.
2003/0127447 A1	7/2003	Lin	2013/0104875 A1	5/2013	Schultz et al.
2004/0035845 A1	2/2004	Moon et al.	2013/0180413 A1	7/2013	Tjerkgaast et al.
2004/0045446 A1	3/2004	Park	2013/0180986 A1	7/2013	He et al.
2004/0055474 A1	3/2004	Lekic et al.	2013/0196038 A1	8/2013	Liu
2004/0124197 A1	7/2004	Hasegawa	2013/0255509 A1	10/2013	He et al.
2004/0222208 A1	11/2004	Ko	2013/0276643 A1	10/2013	Krolick et al.
2005/0011370 A1	1/2005	Xu et al.	2013/0298781 A1	11/2013	Ganuza et al.
2005/0034716 A1	2/2005	Harbin	2013/0305933 A1	11/2013	Heidrich et al.
2005/0089318 A1	4/2005	Lai et al.	2013/0333685 A1	12/2013	Jeong et al.
2005/0223906 A1	10/2005	Xu	2014/0021191 A1	1/2014	Moon et al.
2005/0284305 A1	12/2005	Angue	2014/0083306 A1	3/2014	Lee
2006/0081235 A1	4/2006	Lundh et al.	2014/0083992 A1	3/2014	Linnewiel
2007/0045284 A1	3/2007	Balk et al.	2014/0102315 A1	4/2014	Park
2007/0095215 A1	5/2007	Ho et al.	2014/0157994 A1	6/2014	Ryan et al.
2007/0125768 A1	6/2007	Kim et al.	2014/0175085 A1	6/2014	Yang et al.
2007/0158335 A1	7/2007	Mansbery	2014/0199459 A1	7/2014	Jackson et al.
			2014/0201688 A1	7/2014	Guilleminot et al.
			2014/0220196 A1	8/2014	Veloo
			2014/0227411 A1	8/2014	Popeil et al.
			2014/0245898 A1	9/2014	Froza

(56)

References Cited

U.S. PATENT DOCUMENTS

2014/0251158	A1	9/2014	Yang et al.	2016/0353914	A1	12/2016	Chameroy et al.
2014/0318385	A1	10/2014	Kim	2016/0353915	A1	12/2016	Chameroy et al.
2014/0318386	A1	10/2014	Kim	2016/0353916	A1	12/2016	Chameroy et al.
2014/0318387	A1	10/2014	Kim	2016/0360922	A1	12/2016	Xiao et al.
2014/0318388	A1	10/2014	Kim	2016/0367061	A1	12/2016	Chou
2014/0318389	A1	10/2014	Kim	2016/0374510	A1	12/2016	Albizuri Landazabal
2014/0322417	A1	10/2014	Kim	2017/0000293	A1	1/2017	Sladeczek et al.
2014/0348987	A1	11/2014	Cheng et al.	2017/0020334	A1	1/2017	Sorenson et al.
2014/0353316	A1	12/2014	Lin	2017/0055770	A1	3/2017	Case
2014/0360384	A1	12/2014	Kim	2017/0065127	A1	3/2017	Bonaccorso
2014/0366746	A1	12/2014	Tsai	2017/0071034	A1	3/2017	Metz
2014/0370176	A1	12/2014	Imura et al.	2017/0079475	A1	3/2017	Buckley et al.
2014/0377417	A1	12/2014	Martinez	2017/0089590	A1	3/2017	Bruin-Slot et al.
2015/0000535	A1	1/2015	Yoshidome et al.	2017/0099977	A1	4/2017	Liu
2015/0040775	A1	2/2015	Shieh	2017/0099984	A1	4/2017	Koetz
2015/0083107	A1	3/2015	Busch et al.	2017/0099990	A1	4/2017	Magnouloux et al.
2015/0122137	A1	5/2015	Chang	2017/0099995	A1	4/2017	Magnouloux
2015/0136769	A1	5/2015	Quinn et al.	2017/0119192	A1	5/2017	Sanserverino
2015/0201788	A1*	7/2015	Douma A47J 27/04 99/330	2017/0172335	A1	6/2017	Colas et al.
2015/0201806	A1	7/2015	Yoshidome	2017/0181564	A1	6/2017	He et al.
2015/0208845	A1	7/2015	Robbins et al.	2017/0199658	A1	7/2017	Stoufer et al.
2015/0208858	A1	7/2015	Robbins et al.	2017/0231415	A1	8/2017	Cheng et al.
2015/0223627	A1	8/2015	Li et al.	2017/0231430	A1	8/2017	Moon et al.
2015/0226438	A1	8/2015	Ozyurt et al.	2017/0245674	A1	8/2017	Imura
2015/0250187	A1	9/2015	Sakane et al.	2017/0245683	A1	8/2017	Chen et al.
2015/0257208	A1	9/2015	Li et al.	2017/0245686	A1	8/2017	Man
2015/0292750	A1	10/2015	Delrue et al.	2017/0251872	A1	9/2017	Li et al.
2015/0305093	A1	10/2015	Smith et al.	2017/0251874	A1	9/2017	Sladeczek
2015/0313399	A1	11/2015	Park	2017/0280914	A1	10/2017	Kumar et al.
2015/0351578	A1	12/2015	Song et al.	2017/0290452	A1	10/2017	Guillaume et al.
2015/0366402	A1	12/2015	Wu et al.	2017/0295993	A1	10/2017	Li et al.
2016/0007644	A1	1/2016	Hack et al.	2017/0303740	A1	10/2017	Bonaccorso
2016/0007789	A1	1/2016	Tiruvallur	2017/0332823	A1	11/2017	Sanseverino
2016/0029829	A1	2/2016	Klein	2017/0360238	A1	12/2017	Bogazzi
2016/0033141	A1	2/2016	Rizzuto	2017/0360254	A1	12/2017	Muhr et al.
2016/0037955	A1	2/2016	Kim	2017/0360255	A1	12/2017	Karau
2016/0045067	A1	2/2016	Liao	2017/0367514	A1	12/2017	In 'T Groen et al.
2016/0051077	A1	2/2016	Sloot et al.	2017/0370595	A1	12/2017	Yang et al.
2016/0051078	A1	2/2016	Jenkins et al.	2018/0000285	A1	1/2018	Backus et al.
2016/0051086	A1	2/2016	De' Longhi	2018/0007738	A1	1/2018	Knappenberger et al.
2016/0081509	A1	3/2016	Delrue et al.	2018/0007744	A1	1/2018	Nonaka et al.
2016/0100707	A1	4/2016	Huang	2018/0028017	A1	2/2018	Wu
2016/0100713	A1	4/2016	De Haas et al.	2018/0035698	A1	2/2018	McNerney et al.
2016/0113442	A1	4/2016	De Haas et al.	2018/0073739	A1	3/2018	Dumenil
2016/0120363	A1	5/2016	Zwanenburg et al.	2018/0078089	A1	3/2018	Sauer et al.
2016/0120364	A1	5/2016	De Haas et al.	2018/0103796	A1	4/2018	Park
2016/0123660	A1	5/2016	Peng	2018/0110355	A1	4/2018	Huang et al.
2016/0165676	A1	6/2016	Imm et al.	2018/0116264	A1	5/2018	De Winter et al.
2016/0174749	A1	6/2016	Eades et al.	2018/0116438	A1	5/2018	He et al.
2016/0174764	A1	6/2016	Xiao	2018/0125293	A1	5/2018	McNerney et al.
2016/0174771	A1	6/2016	Benoit et al.	2018/0125294	A1	5/2018	Conte et al.
2016/0183722	A1	6/2016	Fisher	2018/0140126	A1	5/2018	Van Dillen
2016/0206139	A1	6/2016	Johnson	2018/0143086	A1	5/2018	Stoufer et al.
2016/0206140	A1	6/2016	Johnson et al.	2018/0153329	A1	6/2018	Glucksman et al.
2016/0192808	A1	7/2016	Van Der Burg et al.	2018/0160840	A1	6/2018	De' Longhi
2016/0198882	A1	7/2016	Linglin	2018/0160849	A1	6/2018	Hebert, Jr. et al.
2016/0198883	A1	7/2016	Wang et al.	2018/0177322	A1	6/2018	Kim
2016/0206131	A1	7/2016	Chien	2018/0177343	A1	6/2018	Bonaccorso
2016/0219653	A1	7/2016	Kim et al.	2018/0184843	A1	7/2018	Kim et al.
2016/0220057	A1	8/2016	Smith et al.	2018/0184848	A1	7/2018	De' Longhi
2016/0235078	A1	8/2016	Farina et al.	2018/0192825	A1	7/2018	Popeil et al.
2016/0235239	A1	8/2016	Patadia	2018/0199756	A1	7/2018	Huang
2016/0253080	A1	9/2016	Ban et al.	2018/0206672	A1	7/2018	Grace et al.
2016/0270596	A1	9/2016	Allemand et al.	2018/0206677	A1	7/2018	Ivarsson et al.
2016/0278563	A1	9/2016	Choudhary	2018/0220498	A1	8/2018	Jeon et al.
2016/0278565	A1	9/2016	Chameroy et al.	2018/0220842	A1	8/2018	Delrue et al.
2016/0281994	A1	9/2016	Nuessler	2018/0228318	A1	8/2018	Zwanenburg et al.
2016/0309956	A1	10/2016	Glucksman	2018/0238560	A1	8/2018	Deng et al.
2016/0316525	A1	10/2016	Vainionpaa	2018/0255967	A1	9/2018	Haas et al.
2016/0316968	A1	11/2016	Linglin	2018/0255971	A1	9/2018	Moon et al.
2016/0324359	A1	11/2016	Aboujassoum et al.	2018/0263084	A1	9/2018	Yoshino et al.
2016/0327280	A1	11/2016	Smith et al.	2018/0266697	A1	9/2018	Dash et al.
2016/0345766	A1	12/2016	Sapire	2018/0271321	A1	9/2018	Delrue et al.
2016/0353913	A1	12/2016	Chameroy et al.	2018/0271323	A1	9/2018	Zhang et al.
				2018/0279832	A1	10/2018	Ohta et al.
				2018/0279836	A1	10/2018	Prithviraj et al.
				2018/0289212	A1	10/2018	Sladeczek et al.
				2018/0296019	A1	10/2018	Kim et al.
				2018/0303285	A1	10/2018	Cheng

(56)

References Cited

U.S. PATENT DOCUMENTS

2018/0317691 A1 11/2018 Huang
 2018/0317692 A1 11/2018 Huang
 2018/0317693 A1 11/2018 Huang
 2018/0325313 A1 11/2018 De' Longhi et al.
 2018/0325318 A1 11/2018 De Longhi et al.
 2018/0325322 A1 11/2018 De'Longhi et al.
 2018/0333004 A1 11/2018 DeLonghi
 2018/0333005 A1 11/2018 Fritz et al.
 2018/0344085 A1 12/2018 Dutter
 2018/0347829 A1 12/2018 Martini et al.
 2018/0353007 A1 12/2018 Eberhart et al.
 2018/0353010 A1 12/2018 Delrue et al.
 2018/0359823 A1 12/2018 Shin et al.
 2019/0000267 A1 1/2019 Li et al.
 2019/0008316 A1 1/2019 Kim et al.
 2019/0021142 A1 1/2019 Mizuta et al.
 2019/0045964 A1 2/2019 Gill et al.
 2019/0045973 A1 2/2019 Gill et al.
 2019/0053521 A1 2/2019 Tian et al.
 2019/0059647 A1 2/2019 Floessholzer
 2019/0069719 A1 3/2019 Huang et al.
 2019/0082876 A1 3/2019 Shi et al.
 2020/0093329 A1 3/2020 Glucksman

FOREIGN PATENT DOCUMENTS

CN 2389593 Y 8/2000
 CN 2450993 Y 10/2001
 CN 2469839 Y 1/2002
 CN 2479871 Y 3/2002
 CN 1139352 C 2/2004
 CN 1148142 C 5/2004
 CN 1158963 C 7/2004
 CN 2719176 y 8/2005
 CN 1883351 A 12/2006
 CN 2855256 Y 1/2007
 CN 2904903 Y 5/2007
 CN 1981682 A 6/2007
 CN 1985727 A 6/2007
 CN 1989884 A 7/2007
 CN 100998476 A 7/2007
 CN 101023842 A 8/2007
 CN 101053485 A 10/2007
 CN 200987595 y 12/2007
 CN 101099635 A 1/2008
 CN 101108064 A 1/2008
 CN 101112291 A 1/2008
 CN 101112292 A 1/2008
 CN 101112293 A 1/2008
 CN 101142448 A 3/2008
 CN 101185556 A 5/2008
 CN 100401957 C 7/2008
 CN 101209179 A 7/2008
 CN 101209180 A 7/2008
 CN 201079267 Y 7/2008
 CN 100425186 C 10/2008
 CN 100428906 C 10/2008
 CN 101273834 A 10/2008
 CN 201139427 y 10/2008
 CN 101322614 A 12/2008
 CN 201197609 Y 2/2009
 CN 100464682 C 3/2009
 CN 100469289 C 3/2009
 CN 201207144 Y 3/2009
 CN 101432608 A 5/2009
 CN 101438929 A 5/2009
 CN 100496350 C 6/2009
 CN 100522018 C 8/2009
 CN 100531628 C 8/2009
 CN 100534363 C 9/2009
 CN 101518409 A 9/2009
 CN 100559999 C 11/2009
 CN 201365839 Y 12/2009
 CN 100588351 C 2/2010
 CN 101669761 A 3/2010

CN 101766443 A 7/2010
 CN 101791190 A 8/2010
 CN 101828856 A 9/2010
 CN 101856086 A 10/2010
 CN 201602600 U 10/2010
 CN 201624512 U 11/2010
 CN 101936550 A 1/2011
 CN 101940273 A 1/2011
 CN 101420893 B 2/2011
 CN 101977536 A 2/2011
 CN 201888709 U 7/2011
 CN 201929758 U 8/2011
 CN 201948771 U 8/2011
 CN 102178445 A 9/2011
 CN 102178464 A 9/2011
 CN 201958652 U 9/2011
 CN 101305890 B 11/2011
 CN 102240164 A 11/2011
 CN 102307500 A 1/2012
 CN 102313306 A 2/2012
 CN 102349791 A 2/2012
 CN 202151310 U 2/2012
 CN 102368936 A 3/2012
 CN 202184614 U 4/2012
 CN 101692958 B 5/2012
 CN 202207075 U 5/2012
 CN 202234720 U 5/2012
 CN 202234761 U 5/2012
 CN 202312886 U 7/2012
 CN 202408428 U 9/2012
 CN 202408455 U 9/2012
 CN 102755120 A 10/2012
 CN 102824120 A 12/2012
 CN 202619362 U 12/2012
 CN 102100481 B 1/2013
 CN 102883641 A 1/2013
 CN 202636678 U 1/2013
 CN 103006045 A 4/2013
 CN 103006092 A 4/2013
 CN 202858889 U 4/2013
 CN 103142128 A 6/2013
 CN 103142151 A 6/2013
 CN 103169371 A 6/2013
 CN 103179884 A 6/2013
 CN 202960194 U 6/2013
 CN 202981682 U 6/2013
 CN 203000535 U 6/2013
 CN 103188947 A 7/2013
 CN 103188970 A 7/2013
 CN 103220947 A 7/2013
 CN 103222807 A 7/2013
 CN 203041954 U 7/2013
 CN 203041955 U 7/2013
 CN 102342739 B 8/2013
 CN 203122175 U 8/2013
 CN 103299132 A 9/2013
 CN 203195497 U 9/2013
 CN 203195499 U 9/2013
 CN 103375826 A 10/2013
 CN 203234602 U 10/2013
 CN 203234613 U 10/2013
 CN 102319018 B 11/2013
 CN 203302862 U 11/2013
 CN 103445669 A 12/2013
 CN 103491830 A 1/2014
 CN 203407931 U 1/2014
 CN 103649643 A 3/2014
 CN 103750730 A 4/2014
 CN 203539138 U 4/2014
 CN 203597772 U 5/2014
 CN 203615383 U 5/2014
 CN 203634023 U 6/2014
 CN 203647141 U 6/2014
 CN 203662545 U 6/2014
 CN 103892696 A 7/2014
 CN 103948308 A 7/2014
 CN 203693372 U 7/2014
 CN 203723888 U 7/2014
 CN 104000478 A 8/2014

(56)

References Cited

FOREIGN PATENT DOCUMENTS

CN	203762926	U	8/2014	CN	105380512	A	3/2016
CN	203776718	U	8/2014	CN	105380513	A	3/2016
CN	203776719	U	8/2014	CN	105380514	A	3/2016
CN	203776729	U	8/2014	CN	105411378	A	3/2016
CN	203828675	U	9/2014	CN	105411379	A	3/2016
CN	203873602	U	10/2014	CN	105433778	A	3/2016
CN	203885286	U	10/2014	CN	105433779	A	3/2016
CN	203953373	U	11/2014	CN	105451610	A	3/2016
CN	203970073	U	12/2014	CN	105455628	A	4/2016
CN	203970160	U	12/2014	CN	105455664	A	4/2016
CN	203987492	U	12/2014	CN	105455671	A	4/2016
CN	203987520	U	12/2014	CN	105476461	A	4/2016
CN	203987550	U	12/2014	CN	105476464	A	4/2016
CN	203987551	U	12/2014	CN	105476472	A	4/2016
CN	204016055	U	12/2014	CN	105476491	A	4/2016
CN	204016056	U	12/2014	CN	105496184	A	4/2016
CN	204049362	U	12/2014	CN	105496185	A	4/2016
CN	204091768	U	1/2015	CN	105496224	A	4/2016
CN	104323708	A	2/2015	CN	205126014	U	4/2016
CN	104367182	A	2/2015	CN	105534269	A	5/2016
CN	204133165	U	2/2015	CN	105559571	A	5/2016
CN	204133291	U	2/2015	CN	105595792	A	5/2016
CN	204158183	U	2/2015	CN	105595803	A	5/2016
CN	104433841	A	3/2015	CN	205197727	U	5/2016
CN	204192406	U	3/2015	CN	205214967	U	5/2016
CN	104490294	A	4/2015	CN	205215045	U	5/2016
CN	102917623	B	5/2015	CN	102783908	B	6/2016
CN	104613515	A	5/2015	CN	103648337	B	6/2016
CN	104622274	A	5/2015	CN	105615638	A	6/2016
CN	104676681	A	6/2015	CN	105615639	A	6/2016
CN	104688019	A	6/2015	CN	105615686	A	6/2016
CN	104706212	A	6/2015	CN	105640299	A	6/2016
CN	104754992	A	7/2015	CN	105640302	A	6/2016
CN	104757872	A	7/2015	CN	105640309	A	6/2016
CN	104814665	A	8/2015	CN	105640351	A	6/2016
CN	104856561	A	8/2015	CN	105662112	A	6/2016
CN	104856563	A	8/2015	CN	105662125	A	6/2016
CN	204580991	U	8/2015	CN	105662126	A	6/2016
CN	104873098	A	9/2015	CN	105662127	A	6/2016
CN	104887063	A	9/2015	CN	105708312	A	6/2016
CN	204636063	U	9/2015	CN	205322075	U	6/2016
CN	104983318	A	10/2015	CN	104605727	B	7/2016
CN	104997394	A	10/2015	CN	105725730	A	7/2016
CN	204697804	U	10/2015	CN	105725829	A	7/2016
CN	105011741	A	11/2015	CN	105768859	A	7/2016
CN	105030035	A	11/2015	CN	105768860	A	7/2016
CN	105054772	B	11/2015	CN	103908166	B	8/2016
CN	105054773	B	11/2015	CN	105816023	A	8/2016
CN	204734374	U	11/2015	CN	105832176	A	8/2016
CN	204743846	U	11/2015	CN	105852667	A	8/2016
CN	204765197	U	11/2015	CN	105852668	A	8/2016
CN	204797615	U	11/2015	CN	105902144	A	8/2016
CN	204797616	U	11/2015	CN	105902150	A	8/2016
CN	103813738	B	12/2015	CN	205410811	U	8/2016
CN	105105624	A	12/2015	CN	205425108	U	8/2016
CN	105105626	A	12/2015	CN	205433281	U	8/2016
CN	105167591	B	12/2015	CN	205433317	U	8/2016
CN	105167592	A	12/2015	CN	205433320	U	8/2016
CN	105193301	A	12/2015	CN	105919411	A	9/2016
CN	204839219	U	12/2015	CN	105919417	A	9/2016
CN	204889693	U	12/2015	CN	105935244	A	9/2016
CN	105212693	B	1/2016	CN	105935258	A	9/2016
CN	105212730	A	1/2016	CN	105972653	A	9/2016
CN	105231811	A	1/2016	CN	205568641	U	9/2016
CN	105231812	A	1/2016	CN	205568772	U	9/2016
CN	105231813	A	1/2016	CN	205597052	U	9/2016
CN	105266565	A	1/2016	CN	105982529	A	10/2016
CN	105266577	A	1/2016	CN	105996737	A	10/2016
CN	204995259	U	1/2016	CN	105996752	A	10/2016
CN	105286496	A	2/2016	CN	105996753	A	10/2016
CN	105286498	A	2/2016	CN	106037448	A	10/2016
CN	105286627	A	2/2016	CN	106037457	A	10/2016
CN	105326332	A	2/2016	CN	106037458	A	10/2016
CN	105342454	A	2/2016	CN	106037458	A	10/2016
CN	205018878	U	2/2016	CN	106073481	A	11/2016
				CN	106073517	A	11/2016
				CN	106108627	A	11/2016
				CN	106108631	A	11/2016
				CN	106166030	A	11/2016
				CN	205671926	U	11/2016

(56)

References Cited

FOREIGN PATENT DOCUMENTS

CN	205671927	U	11/2016	CN	107296493	A	10/2017
CN	106175412	A	12/2016	CN	107296494	A	10/2017
CN	106175476	A	12/2016	CN	104643954	B	11/2017
CN	106213979	A	12/2016	CN	107307729	A	11/2017
CN	106235878	A	12/2016	CN	107307730	A	11/2017
CN	205831665	U	12/2016	CN	107361637	A	11/2017
CN	106264085	A	1/2017	CN	107397431	A	11/2017
CN	106264095	A	1/2017	CN	107411540	A	12/2017
CN	106343895	A	1/2017	CN	107440490	A	12/2017
CN	205860134	U	1/2017	CN	107468052	A	12/2017
CN	106377158	A	2/2017	CN	107495849	A	12/2017
CN	106377159	A	2/2017	CN	107495856	A	12/2017
CN	106388565	A	2/2017	CN	107510356	A	12/2017
CN	106388572	A	2/2017	CN	107510379	A	12/2017
CN	106419486	A	2/2017	CN	206687606	U	12/2017
CN	106419521	A	2/2017	CN	106213986	B	1/2018
CN	106419524	A	2/2017	CN	107550258	A	1/2018
CN	102805554	B	3/2017	CN	107616686	A	1/2018
CN	106473623	A	3/2017	CN	107647763	A	2/2018
CN	106490967	A	3/2017	CN	107647769	A	2/2018
CN	106510449	A	3/2017	CN	107647771	A	2/2018
CN	206026100	U	3/2017	CN	107647772	A	2/2018
CN	206044349	U	3/2017	CN	107647777	A	2/2018
CN	106551617	A	4/2017	CN	107660996	A	2/2018
CN	106580074	A	4/2017	CN	107660997	A	2/2018
CN	206062888	U	4/2017	CN	107684336	A	2/2018
CN	206102391	U	4/2017	CN	107684337	A	2/2018
CN	206119969	U	4/2017	CN	107684338	A	2/2018
CN	106618154	A	5/2017	CN	107684339	A	2/2018
CN	106667244	A	5/2017	CN	107684340	A	2/2018
CN	106691171	A	5/2017	CN	107684341	A	2/2018
CN	206166726	U	5/2017	CN	107684342	A	2/2018
CN	106805744	A	6/2017	CN	107692806	A	2/2018
CN	106805746	A	6/2017	CN	107702838	A	2/2018
CN	106805747	A	6/2017	CN	107713732	A	2/2018
CN	106805749	A	6/2017	CN	107713733	A	2/2018
CN	106805750	A	6/2017	CN	107713734	A	2/2018
CN	106805752	A	6/2017	CN	107726388	A	2/2018
CN	106820951	A	6/2017	CN	106419522	B	3/2018
CN	106820954	A	6/2017	CN	107752726	A	3/2018
CN	106821017	A	6/2017	CN	107752748	A	3/2018
CN	106852641	A	6/2017	CN	107752751	A	3/2018
CN	106859298	A	6/2017	CN	107752788	A	3/2018
CN	106913201	A	7/2017	CN	107773021	A	3/2018
CN	106923655	A	7/2017	CN	107773026	A	3/2018
CN	106943000	A	7/2017	CN	107773029	A	3/2018
CN	106943002	A	7/2017	CN	107773090	A	3/2018
CN	106955017	A	7/2017	CN	107788820	A	3/2018
CN	106974548	A	7/2017	CN	107788827	A	3/2018
CN	106983360	A	7/2017	CN	107811499	A	3/2018
CN	107019418	A	8/2017	CN	107811517	A	3/2018
CN	107019419	A	8/2017	CN	107811518	A	3/2018
CN	107019420	A	8/2017	CN	107822492	A	3/2018
CN	107019423	A	8/2017	CN	107822494	A	3/2018
CN	107048976	A	8/2017	CN	107822496	A	3/2018
CN	107048991	A	8/2017	CN	107836981	A	3/2018
CN	107048993	A	8/2017	CN	107836986	A	3/2018
CN	107105914	A	8/2017	CN	107836988	A	3/2018
CN	104334066	B	9/2017	CN	207084680	U	3/2018
CN	107136910	A	9/2017	CN	107874584	A	4/2018
CN	107136911	A	9/2017	CN	107874599	A	4/2018
CN	107149395	A	9/2017	CN	107874601	A	4/2018
CN	107149398	A	9/2017	CN	107874602	A	4/2018
CN	105142473	B	10/2017	CN	107898351	A	4/2018
CN	107224188	A	10/2017	CN	107928388	A	4/2018
CN	107224197	A	10/2017	CN	107928395	A	4/2018
CN	107232962	A	10/2017	CN	107951369	A	4/2018
CN	107259978	A	10/2017	CN	107951376	A	4/2018
CN	107290094	A	10/2017	CN	107951407	A	4/2018
CN	107296485	A	10/2017	CN	107969907	A	5/2018
CN	107296486	A	10/2017	CN	107969908	A	5/2018
CN	107296487	A	10/2017	CN	107981713	A	5/2018
CN	107296488	A	10/2017	CN	107997571	A	5/2018
CN	107296489	A	10/2017	CN	108013742	A	5/2018
CN	107296490	A	10/2017	CN	108013743	A	5/2018
				CN	108030404	A	5/2018
				CN	108041976	A	5/2018
				CN	108095570	A	6/2018
				CN	108113501	A	6/2018

(56)

References Cited

FOREIGN PATENT DOCUMENTS

CN	108143256	A	6/2018	CN	108703675	A	10/2018
CN	108143259	A	6/2018	CN	106580073	B	11/2018
CN	108143260	A	6/2018	CN	108720548	A	11/2018
CN	108143261	A	6/2018	CN	108720577	A	11/2018
CN	108143262	A	6/2018	CN	108720581	A	11/2018
CN	108143263	A	6/2018	CN	108720584	A	11/2018
CN	108143264	A	6/2018	CN	108720585	A	11/2018
CN	108158429	A	6/2018	CN	108720586	A	11/2018
CN	108209547	A	6/2018	CN	108720633	A	11/2018
CN	104207651	B	7/2018	CN	108732958	A	11/2018
CN	106175423	A	7/2018	CN	108771466	A	11/2018
CN	108244994	A	7/2018	CN	108784323	A	11/2018
CN	108244995	A	7/2018	CN	108784324	A	11/2018
CN	108244997	A	7/2018	CN	108784330	A	11/2018
CN	108244998	A	7/2018	CN	108784401	A	11/2018
CN	108244999	A	7/2018	CN	108814274	A	11/2018
CN	108245000	A	7/2018	CN	108836104	A	11/2018
CN	108261055	A	7/2018	CN	108836105	A	11/2018
CN	108261056	A	7/2018	CN	108836107	A	11/2018
CN	108261061	A	7/2018	CN	108836108	A	11/2018
CN	108272336	A	7/2018	CN	108836131	A	11/2018
CN	108272338	A	7/2018	CN	108851966	A	11/2018
CN	108294616	A	7/2018	CN	108851969	A	11/2018
CN	108309035	A	7/2018	CN	108851969	A	11/2018
CN	108324096	A	7/2018	CN	108888087	A	11/2018
CN	106388570	B	8/2018	CN	108888099	A	11/2018
CN	106419517	B	8/2018	CN	108903620	A	11/2018
CN	108354444	A	8/2018	CN	108903621	A	11/2018
CN	108354466	A	8/2018	CN	106419520	B	12/2018
CN	108378678	A	8/2018	CN	106419526	B	12/2018
CN	108378690	A	8/2018	CN	108926239	A	12/2018
CN	108402888	A	8/2018	CN	108926249	A	12/2018
CN	108402889	A	8/2018	CN	108937520	A	12/2018
CN	108402920	A	8/2018	CN	108937525	A	12/2018
CN	108420304	A	8/2018	CN	108937556	A	12/2018
CN	108433517	A	8/2018	CN	108937558	A	12/2018
CN	108433529	A	8/2018	CN	108937559	A	12/2018
CN	108451351	A	8/2018	CN	108937560	A	12/2018
CN	108451388	A	8/2018	CN	108955959	A	12/2018
CN	108464732	A	8/2018	CN	108968659	A	12/2018
CN	207754989	U	8/2018	CN	108968660	A	12/2018
CN	207755036	U	8/2018	CN	108968662	A	12/2018
CN	106539491	B	9/2018	CN	108968663	A	12/2018
CN	107019415	B	9/2018	CN	108968667	A	12/2018
CN	107019416	B	9/2018	CN	108968668	A	12/2018
CN	108477987	A	9/2018	CN	108968669	A	12/2018
CN	108497908	A	9/2018	CN	108991918	A	12/2018
CN	108497914	A	9/2018	CN	108991919	A	12/2018
CN	108497918	A	9/2018	CN	109008595	A	12/2018
CN	108497942	A	9/2018	CN	109008598	A	12/2018
CN	108523647	A	9/2018	CN	208259529	U	12/2018
CN	108523649	A	9/2018	CN	106562666	B	1/2019
CN	108552969	A	9/2018	CN	106606293	B	1/2019
CN	108552989	A	9/2018	CN	106724784	B	1/2019
CN	108567309	A	9/2018	CN	106820956	B	1/2019
CN	108567321	A	9/2018	CN	106820957	B	1/2019
CN	108567322	A	9/2018	CN	107019417	B	1/2019
CN	108577514	A	9/2018	CN	109247837	A	1/2019
CN	106264094	B	10/2018	CN	106388566	B	3/2019
CN	108606627	A	10/2018	CN	107174116	B	3/2019
CN	108618592	A	10/2018	CN	107174117	B	3/2019
CN	108618593	A	10/2018	CN	109393957	A	3/2019
CN	108618594	A	10/2018	CN	105640308	A	6/2019
CN	108618595	A	10/2018	EP	1767860	A1	3/2007
CN	108618597	A	10/2018	JP	2014200627	A	10/2014
CN	108618651	A	10/2018	JP	2014204770	A	10/2014
CN	108634771	A	10/2018	WO	8911773	A1	11/1989
CN	108634777	A	10/2018	WO	9837796	A1	9/1998
CN	108634807	A	10/2018	WO	9952328	A1	10/1999
CN	108652431	A	10/2018	WO	0044096		7/2000
CN	108652432	A	10/2018	WO	0049839	A1	8/2000
CN	108670021	A	10/2018	WO	2006122643	A1	11/2006
CN	108670023	A	10/2018	WO	2009043812	A1	4/2009
CN	108703644	A	10/2018	WO	2015006891	A1	1/2015
CN	108703645	A	10/2018	WO	2015028940	A1	3/2015
				WO	2015081549	A1	6/2015
				WO	2016007002	A1	1/2016
				WO	2016028549	A1	2/2016
				WO	2016091063	A1	6/2016
				WO	2016141009	A1	9/2016

(56)

References Cited

FOREIGN PATENT DOCUMENTS

WO 2016148492 A1 9/2016
 WO 2016154114 A1 9/2016
 WO 2016165198 A1 10/2016
 WO 2016171385 A1 10/2016
 WO 2016182975 A1 11/2016
 WO 2016189440 12/2016
 WO 2016193008 A1 12/2016
 WO 2016193643 A1 12/2016
 WO 2017005533 A1 1/2017
 WO 2017039091 A1 3/2017
 WO 2017045387 A1 3/2017
 WO 2017049635 A1 3/2017
 WO 2017049717 A1 3/2017
 WO 2017050693 A2 3/2017
 WO 2017063872 A1 4/2017
 WO 2017072068 A1 5/2017
 WO 2017074119 A1 5/2017
 WO 2017076797 A1 5/2017
 WO 2017081420 A1 5/2017
 WO 2017085026 A1 5/2017
 WO 2017085671 A1 5/2017
 WO 2017085673 A1 5/2017
 WO 2017086543 A1 5/2017
 WO 2017092062 A1 6/2017
 WO 2017092063 A1 6/2017
 WO 2017094968 A1 6/2017
 WO 2017097790 A1 6/2017
 WO 2017104892 A1 6/2017
 WO 2017104894 A1 6/2017
 WO 2017104895 A1 6/2017
 WO 2017104896 A1 6/2017
 WO 2017104898 A1 6/2017
 WO 2017104900 A1 6/2017
 WO 2017105076 A2 6/2017
 WO 2017111425 A1 6/2017
 WO 2017121691 A1 7/2017
 WO 2017127655 A1 7/2017
 WO 2017144795 A1 8/2017
 WO 2017149519 A1 9/2017
 WO 2017152518 A1 9/2017
 WO 2017153360 A1 9/2017
 WO 2017158068 A1 9/2017
 WO 2017166317 A1 10/2017
 WO 2017177007 A1 10/2017
 WO 2017177423 A1 10/2017
 WO 2017178229 A1 10/2017
 WO 2017178650 A1 10/2017
 WO 2017178739 A1 10/2017
 WO 2017179804 A1 10/2017
 WO 2017191377 A1 11/2017
 WO 2017191395 A1 11/2017
 WO 2017195777 A1 11/2017
 WO 2017197482 A1 11/2017
 WO 2017198815 A1 11/2017
 WO 2017198848 A1 11/2017
 WO 2017201530 A1 11/2017
 WO 2017202641 A1 11/2017
 WO 2017209465 A1 12/2017
 WO 2017211045 A1 12/2017
 WO 2017213330 A2 12/2017
 WO 2017213423 A1 12/2017
 WO 2017215926 A1 12/2017
 WO 2017215988 A1 12/2017
 WO 2018004226 A1 1/2018
 WO 2018007218 A1 1/2018
 WO 2018014806 A1 1/2018
 WO 2018015695 A1 1/2018
 WO 2017077571 A1 2/2018
 WO 2018018670 A1 2/2018
 WO 2018023863 A1 2/2018
 WO 2018024781 A1 2/2018
 WO 2018024782 A1 2/2018
 WO 2018024783 A1 2/2018
 WO 2018026041 A1 2/2018
 WO 2018026906 A1 2/2018

WO 2018026928 A1 2/2018
 WO 2018032540 A1 2/2018
 WO 2018032541 A1 2/2018
 WO 2018032542 A1 2/2018
 WO 2018032589 A1 2/2018
 WO 2018032648 A1 2/2018
 WO 2018037177 A1 3/2018
 WO 2018040250 A1 3/2018
 WO 2018041536 A1 3/2018
 WO 2018045643 A1 3/2018
 WO 2018050520 A1 3/2018
 WO 2018050838 A1 3/2018
 WO 2018058384 A1 4/2018
 WO 2018058569 A1 4/2018
 WO 2018058740 A1 4/2018
 WO 2018059994 A1 4/2018
 WO 2018060260 A1 4/2018
 WO 2018060273 A1 4/2018
 WO 2018060331 A1 4/2018
 WO 2018065424 A1 4/2018
 WO 2018068376 A1 4/2018
 WO 2018068425 A1 4/2018
 WO 2018068976 A1 4/2018
 WO 2018076164 A1 5/2018
 WO 2018076166 A1 5/2018
 WO 2018076415 A1 5/2018
 WO 2018082131 A1 5/2018
 WO 2018090287 A1 5/2018
 WO 2018093004 A1 5/2018
 WO 2018095247 A1 5/2018
 WO 2018095420 A1 5/2018
 WO 2018095949 A1 5/2018
 WO 2018120561 A1 5/2018
 WO 2017104893 A1 6/2018
 WO 2018099233 A1 6/2018
 WO 2018102128 A1 6/2018
 WO 2018107522 A1 6/2018
 WO 2018107973 A1 6/2018
 WO 2018116056 A1 6/2018
 WO 2018116057 A1 6/2018
 WO 2018121166 A1 7/2018
 WO 2018121199 A1 7/2018
 WO 2018133993 A1 7/2018
 WO 2018137832 A1 8/2018
 WO 2018140954 A1 8/2018
 WO 2018147640 A1 8/2018
 WO 2018165698 A1 9/2018
 WO 2018197720 A1 11/2018
 WO 2018207221 A1 11/2018
 WO 2018220659 A1 12/2018
 WO 2018223713 A1 12/2018
 WO 2019032876 A1 2/2019
 WO 2019032878 A1 2/2019

OTHER PUBLICATIONS

U.S. Appl. No. 29/653,863, filed Jun. 19, 2018; Restriction Requirement dated Jun. 2, 2020; 7 pages.
 Ninja Kitchen; "Ninja Foodi: Pro Grill"; Announced Aug. 15, 2019 [online]; Site visited Jun. 15, 2020; 14 pages; Available from Internet URL: <https://direct.ninjakitchen.com/16/products/ninja-foodi-grill-ag302/16/microsite/ogxvii/?ppt=2>.
 U.S. Appl. No. 29/733,284, filed Apr. 30, 2020; Non-Final Office Action dated Jun. 25, 2020; 10 pages.
 U.S. Appl. No. 29/679,923, filed Feb. 11, 2019; Restriction Requirement dated May 13, 2020; 8 pages.
 U.S. Appl. No. 29/679,924, filed Feb. 11, 2019; Restriction Requirement dated May 13, 2020; 8 pages.
 U.S. Appl. No. 29/659,571, filed Aug. 9, 2018; Restriction Requirement dated Oct. 1, 2019; pp. 1-8.
 U.S. Appl. No. 29/659,577, filed Aug. 9, 2018; Restriction Requirement dated Oct. 1, 2019; pp. 1-8.
 U.S. Appl. No. 29/660,495, filed Aug. 21, 2018; Food Preparation Device and Parts Thereof; Notice of Allowance dated Oct. 25, 2019; pp. 1-9.

(56)

References Cited

OTHER PUBLICATIONS

U.S. Appl. No. 29/660,472, filed Aug. 21, 2018; Restriction Requirement dated Oct. 1, 2019; pp. 1-8.

U.S. Appl. No. 29/679,920, filed Feb. 11, 2019; User Interface for a Food Preparation Device; Notice of Allowance dated Oct. 23, 2019; pp. 1-10.

U.S. Appl. No. 29/659,576, filed Aug. 9, 2018; Restriction Requirement dated May 19, 2020; 8 pages.

DeLonghi, [online]; [retrieved on Mar. 18, 2019]; retrieved from the Internet <https://www.delonghi.com/en-us/products/kitchen/kitchen-appliances/low-oil-fryer-and-multicooker/multifry-fh11631bk-0125392006?TabSegment=support#supportDeLonghi>, "FH1163 FH1363 MultiFry", DeLonghi Instruction Manual, www.delonghi.com, 5712511041/05.15, pp. 1-11.

Gill et al.; U.S. Appl. No. 16/059,876, filed Aug. 9, 2018; Cooking Device and Components Thereof.

Gill et al.; U.S. Appl. No. 16/059,874, filed Aug. 9, 2018; Cooking Device and Components Thereof.

Gill et al.; Design U.S. Appl. No. 29/653,847, filed Jun. 19, 2018; Air Diffuser and Air Diffuser With Food Preparation Pot.

Notification of Transmittal of the International Search Report of the International Searching Authority, or the Declaration. PCT/US2018/046077, dated Dec. 19, 2018, 7 pages.

Notification of Transmittal of the International Search Report of the International Searching Authority, or the Declaration; PCT/US2018/046079; Jan. 2, 2019, 7 pages.

Notification of Transmittal of the Written Opinion of the International Searching Authority, or the Declaration. PCT/US2018/046077, dated Dec. 19, 2018, 10 pages.

Notification of Transmittal of the Written Opinion of the International Searching Authority, or the Declaration; PCT/US2018/046079; dated Jan. 2, 2019, 10 pages.

WO2018122652A1; Jul. 5, 2018; English Abstract Only (3 Pages).

U.S. Appl. No. 29/679,925, filed Feb. 11, 2019; Restriction Requirement dated May 13, 2020; 8 pages.

U.S. Appl. No. 29/679,922, filed Feb. 11, 2019; Restriction Requirement dated May 13, 2020; 8 pages.

U.S. Appl. No. 29/756,636, filed Oct. 29, 2020; Restriction Requirement dated Jan. 13, 2021; 211 pages.

U.S. Appl. No. 29/756,645, filed Oct. 29, 2020; Notice of Allowance dated Jan. 21, 2021; 183 pages.

U.S. Appl. No. 29/659,576, filed Aug. 9, 2018, Cooking Basket.

U.S. Appl. No. 29/679,922, filed Feb. 11, 2019, Cooking Basket.

U.S. Appl. No. 29/679,923, filed Feb. 11, 2019, Cooking Basket.

U.S. Appl. No. 29/679,924, filed Feb. 11, 2019, Cooking Basket.

U.S. Appl. No. 29/679,925, filed Feb. 11, 2019, Cooking Basket.

U.S. Appl. No. 29/756,636, filed Oct. 29, 2020, Cooking Basket.

U.S. Appl. No. 29/756,645, filed Oct. 29, 2020, Cooking Basket.

* cited by examiner

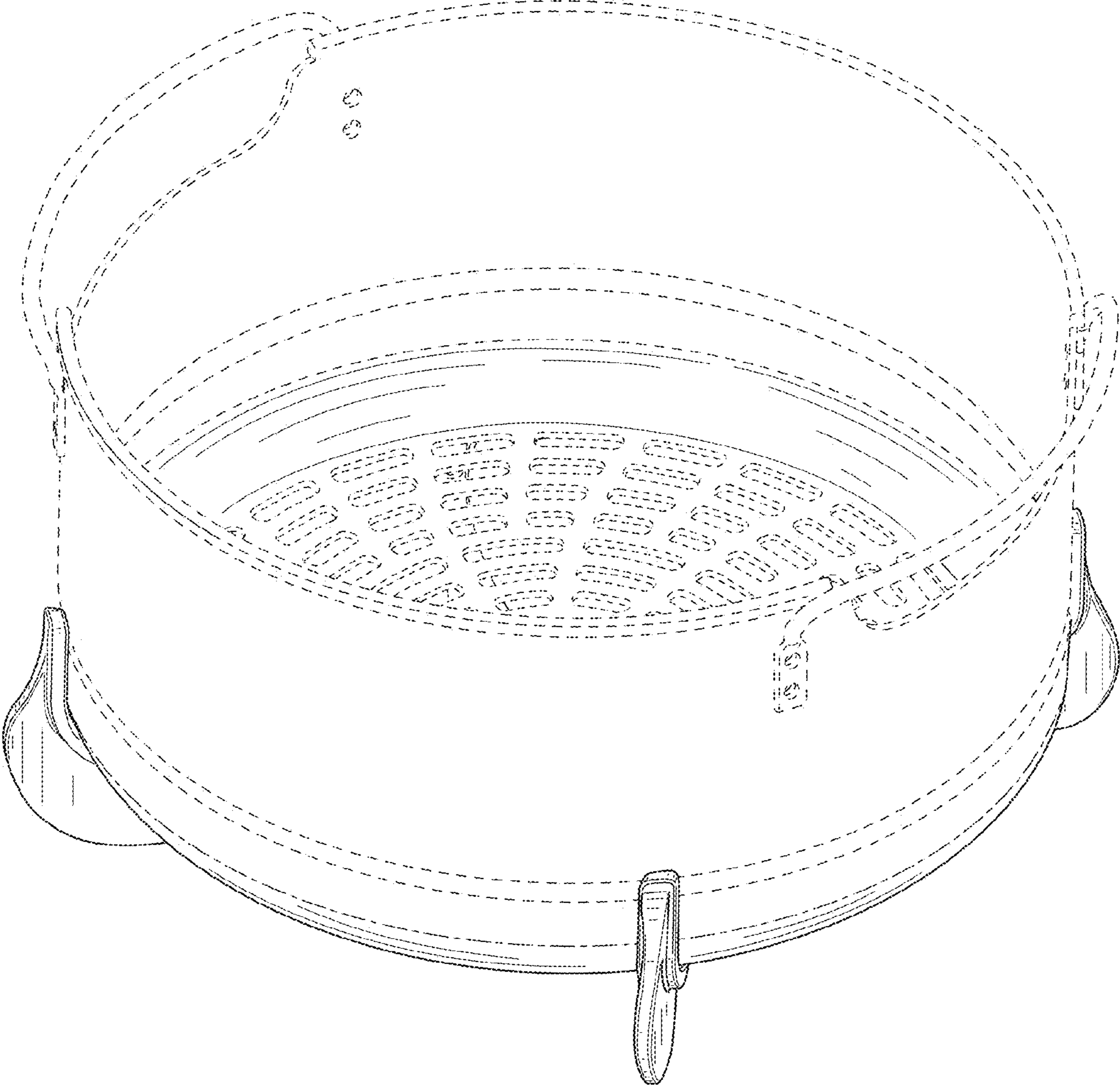

FIG. 1

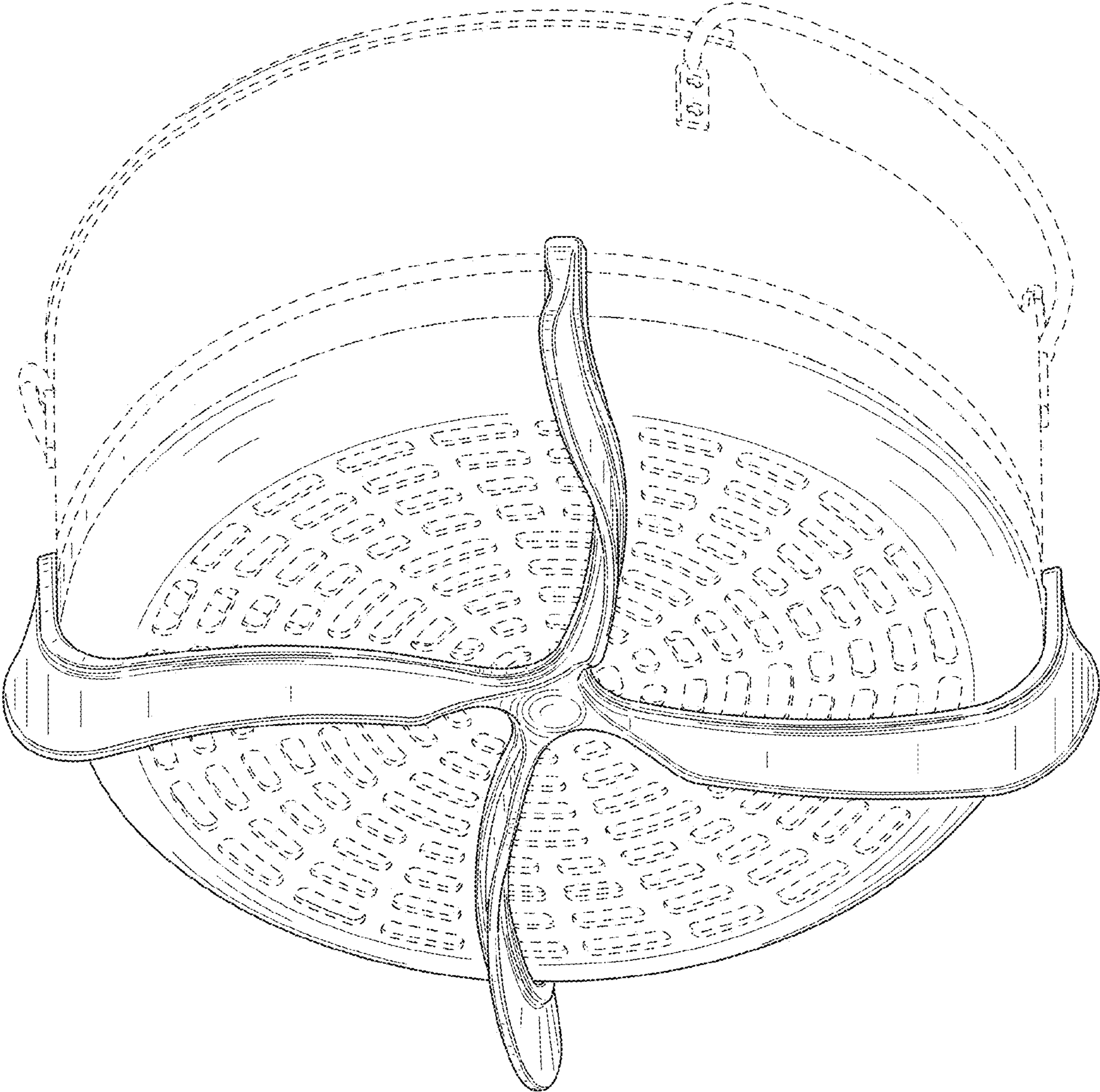

FIG. 2

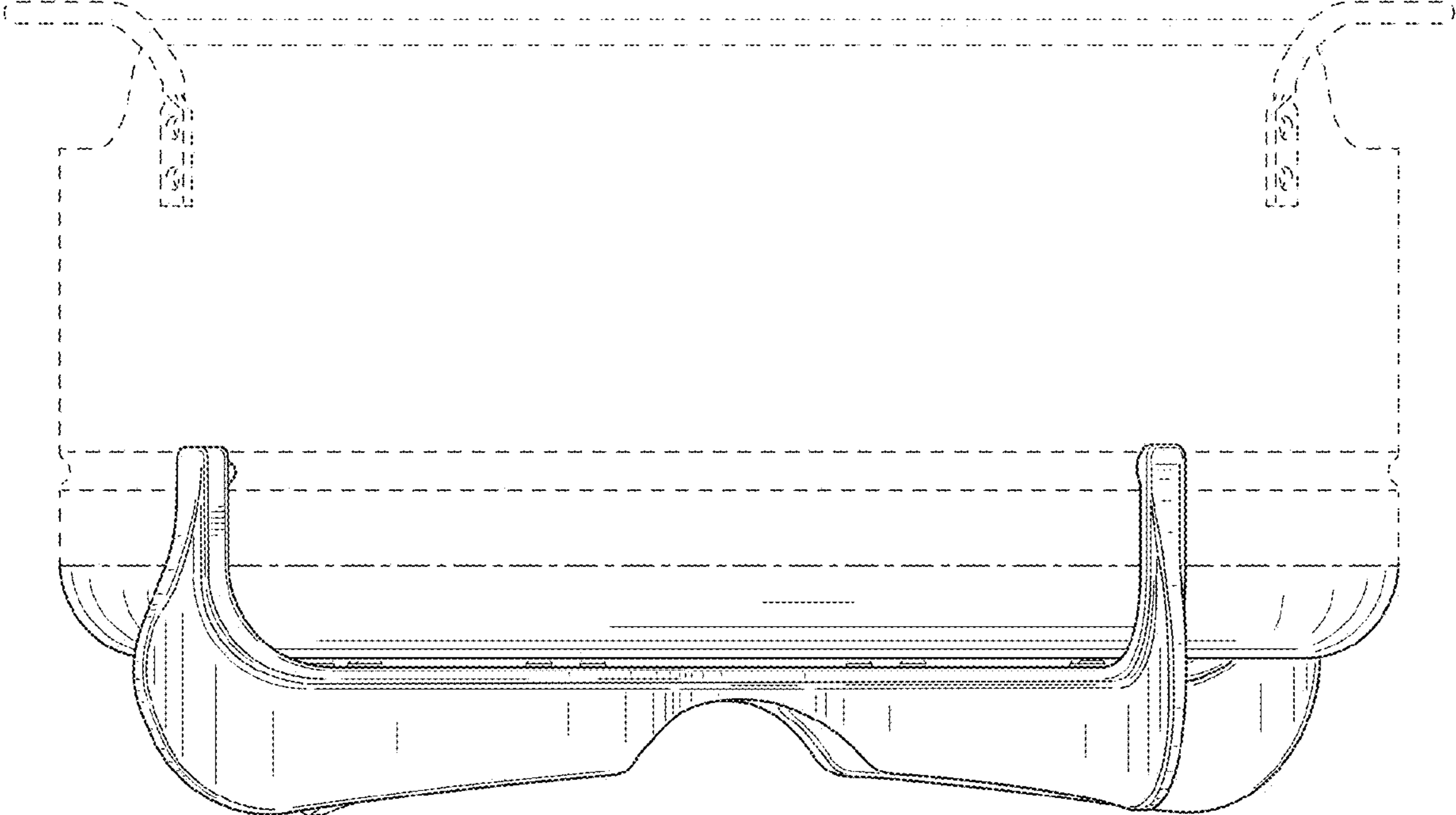

FIG. 3

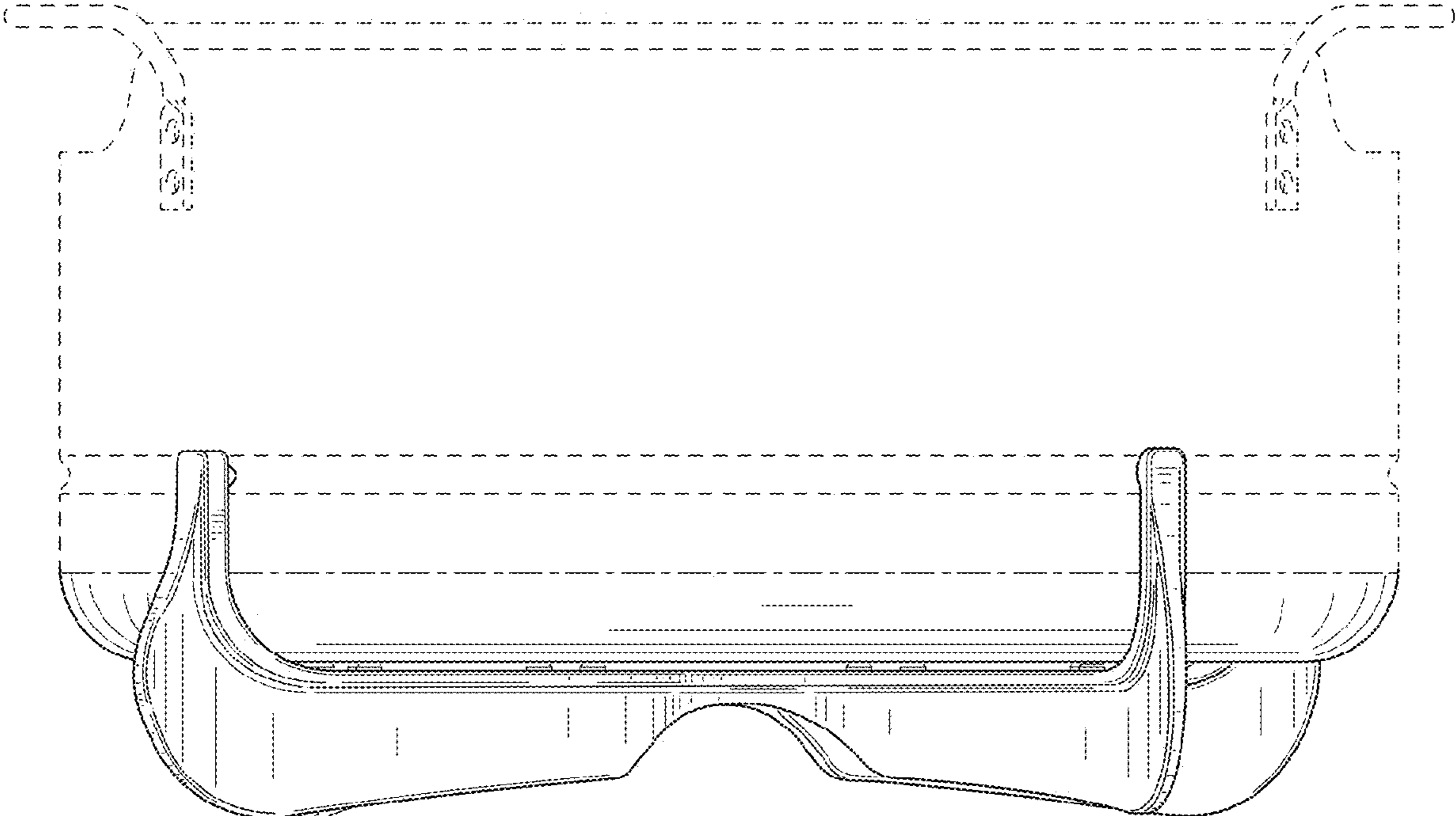

FIG. 4

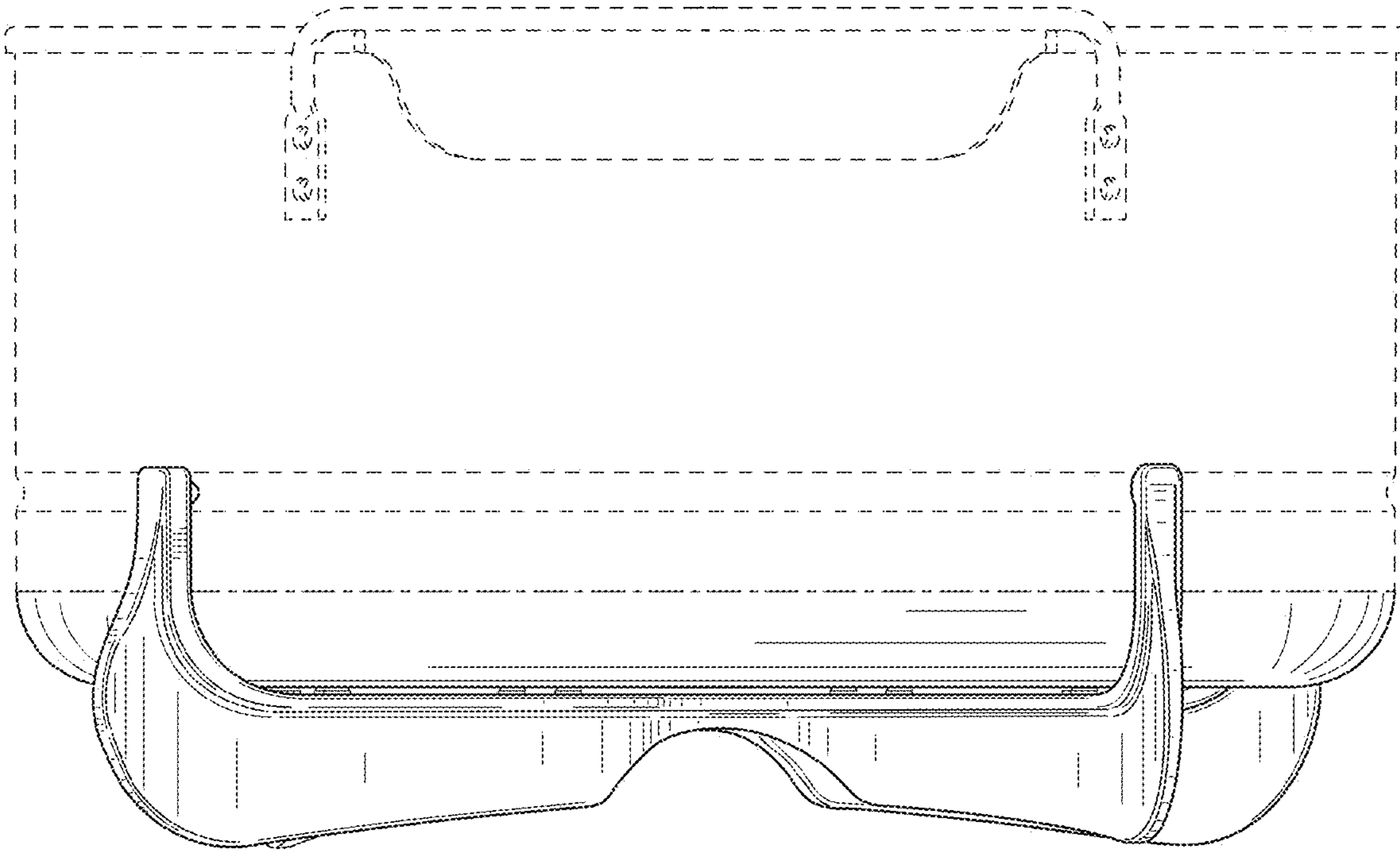

FIG. 5

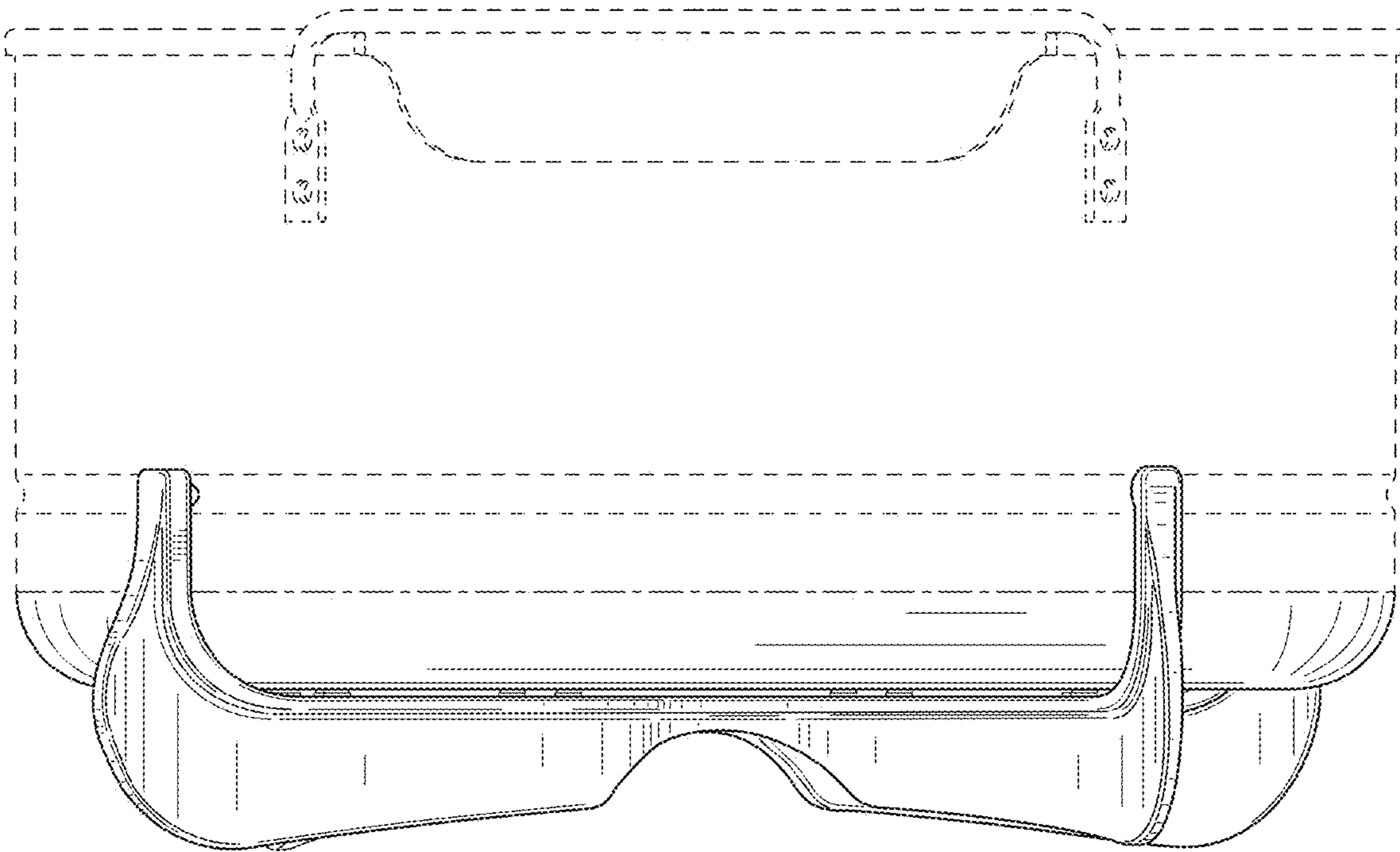

FIG. 6

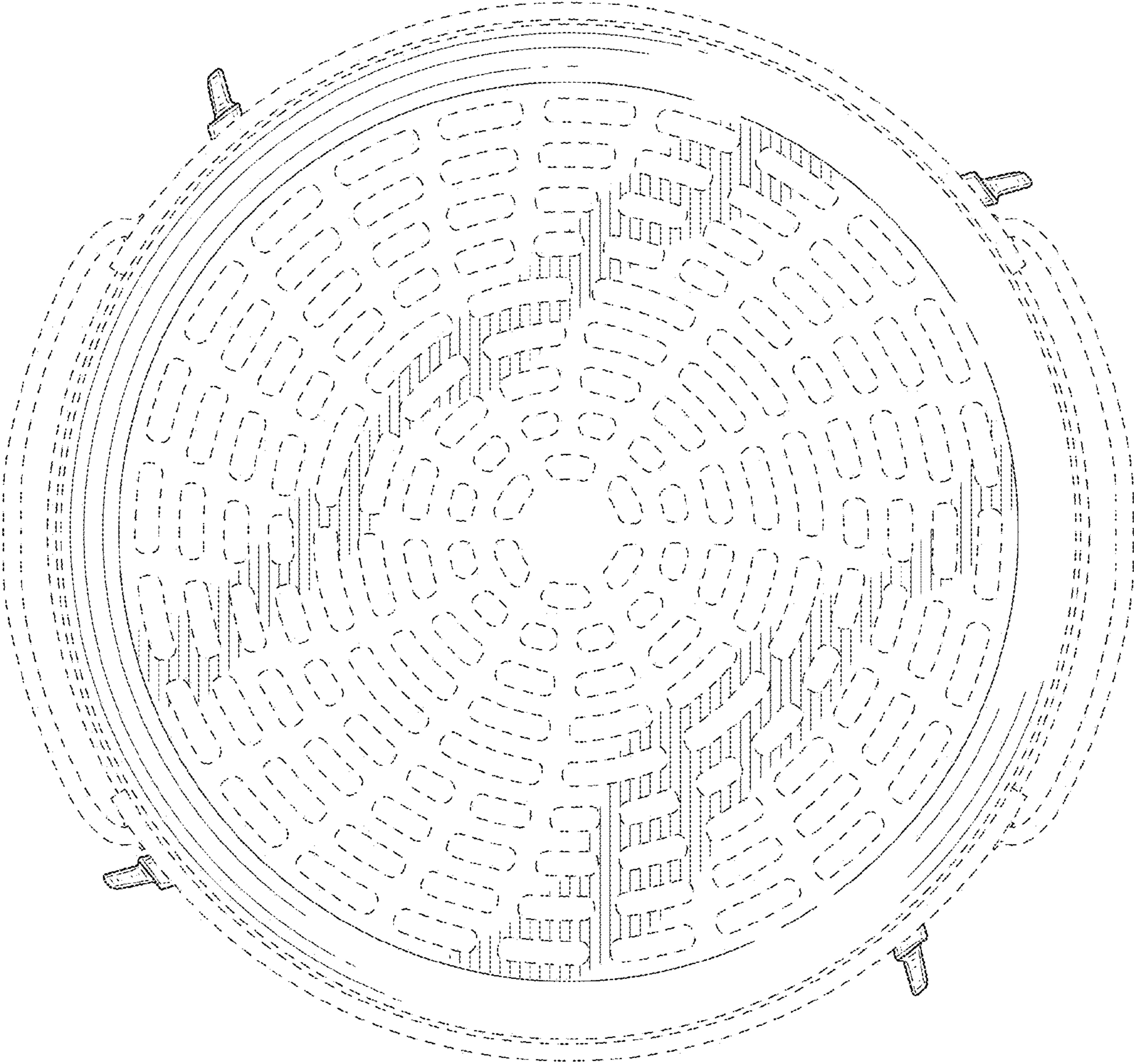

FIG. 7

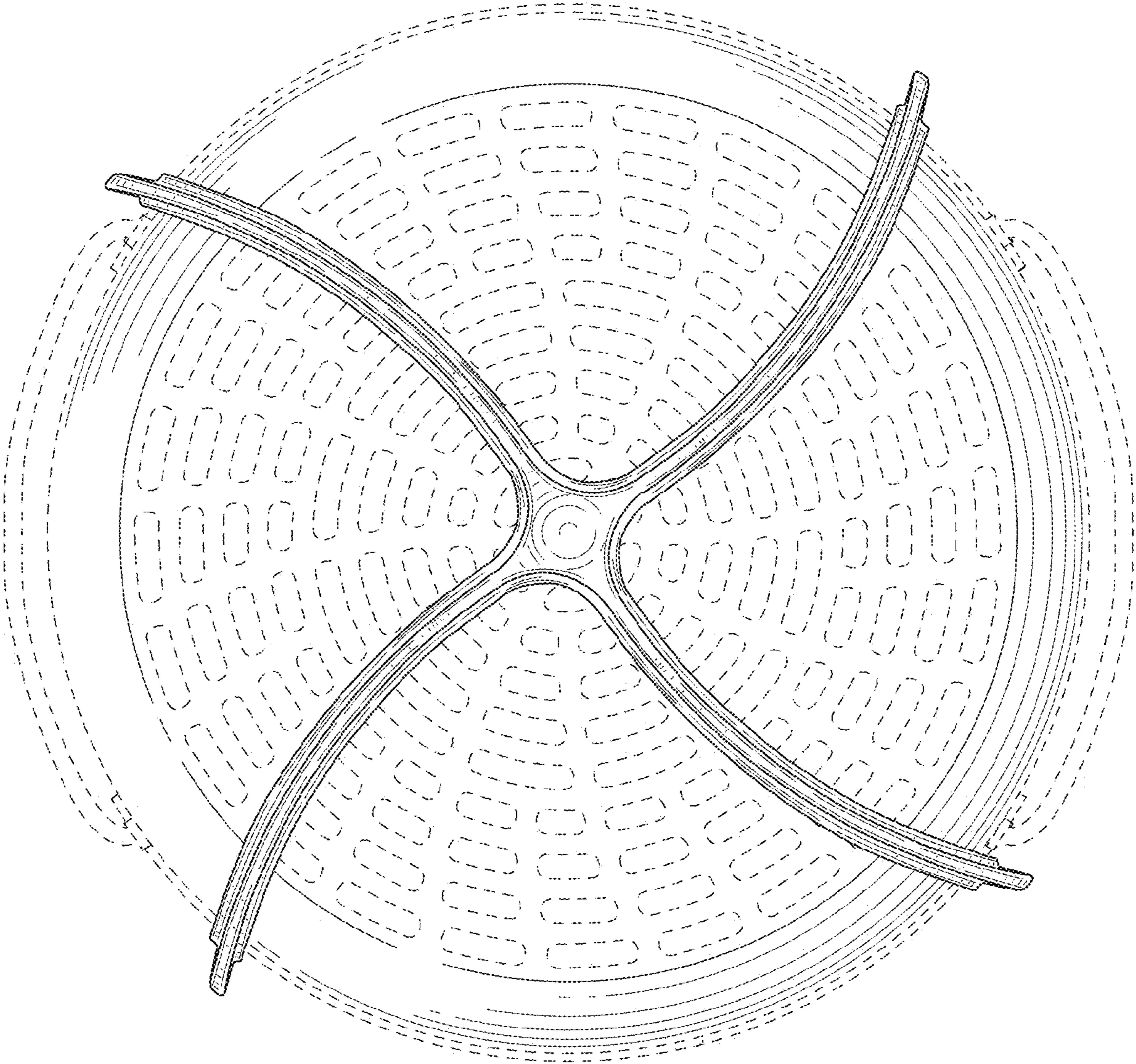

FIG. 8