



US00D940426S

(12) **United States Design Patent**
Maynor Nesbitt

(10) **Patent No.:** **US D940,426 S**
(45) **Date of Patent:** **** Jan. 4, 2022**

- (54) **CART HANDLE SAFETY COVER**
- (71) Applicant: **Gwendolyn Maynor Nesbitt**,
Brandywine, MD (US)
- (72) Inventor: **Gwendolyn Maynor Nesbitt**,
Brandywine, MD (US)
- (**) Term: **15 Years**
- (21) Appl. No.: **29/784,821**
- (22) Filed: **May 21, 2021**
- (51) **LOC (13) Cl.** **12-02**
- (52) **U.S. Cl.**
USPC **D34/27**
- (58) **Field of Classification Search**
USPC D34/27; D25/126, 136, 122
CPC B62B 3/14; B62B 3/1409; B62B 3/1472;
B62B 3/1428; B62B 3/1444; B62B
3/1416; B62B 5/06; B62B 5/069; B62B
5/00
See application file for complete search history.

- 6,869,085 B2 3/2005 Pettigrew
- 6,981,707 B1 * 1/2006 Dandy B62B 5/06
150/154
- D521,207 S * 5/2006 Anderson B62B 5/069
D34/27
- D525,008 S * 7/2006 Hubbard D34/27
- D539,000 S * 3/2007 Perrier D34/27
- D605,823 S * 12/2009 Walter D34/20
- D605,824 S * 12/2009 DiMento D34/27
- D635,733 S * 4/2011 Willig B62B 5/069
D34/27
- D707,009 S * 6/2014 Walter D34/27
- D732,260 S * 6/2015 Wiley D34/27
- D743,663 S * 11/2015 Hoffheimer D34/27
- D746,531 S 12/2015 Barclift et al.
- D779,688 S * 2/2017 Gourley D25/199
- 9,566,994 B1 * 2/2017 Leslie B62B 3/146
- D800,690 S * 10/2017 Groves, Jr. D14/204
- D813,487 S 3/2018 Eskridge
- D830,661 S 10/2018 Jensen et al.
- D919,921 S * 5/2021 McMurtrey D34/27

(Continued)

Primary Examiner — Cynthia Ramirez
(74) *Attorney, Agent, or Firm* — Cramer Patent & Design,
PLLC; Aaron R. Cramer

(56) **References Cited**

U.S. PATENT DOCUMENTS

- 3,866,649 A 2/1975 Bringmann
- D298,077 S * 10/1988 Goodwin B62B 5/069
D34/27
- 4,868,544 A * 9/1989 Havens G08B 13/14
340/568.5
- 4,955,914 A * 9/1990 Caniglia A61J 17/113
606/235
- 4,966,318 A * 10/1990 Dutka A45C 3/00
206/425
- D341,691 S * 11/1993 Begum D34/12
- D412,609 S * 8/1999 Karp D34/27
- 5,953,790 A 9/1999 Auxier
- D425,681 S * 5/2000 Johnson D34/27
- 6,065,764 A * 5/2000 Moseley B62B 5/06
150/154
- 6,543,794 B1 4/2003 Tyree

(57) **CLAIM**

The ornamental design for a cart handle safety cover, as shown and described.

DESCRIPTION

FIG. 1 is a perspective top front right view of a cart handle safety cover, showing my new design;
FIG. 2 is a perspective top rear left view thereof;
FIG. 3 is a front elevation view thereof;
FIG. 4 is a rear elevation view thereof;
FIG. 5 is a top plan view thereof;
FIG. 6 is a bottom plan view thereof;
FIG. 7 is a left elevation view thereof; and,
FIG. 8 is a right elevation view thereof.

1 Claim, 5 Drawing Sheets

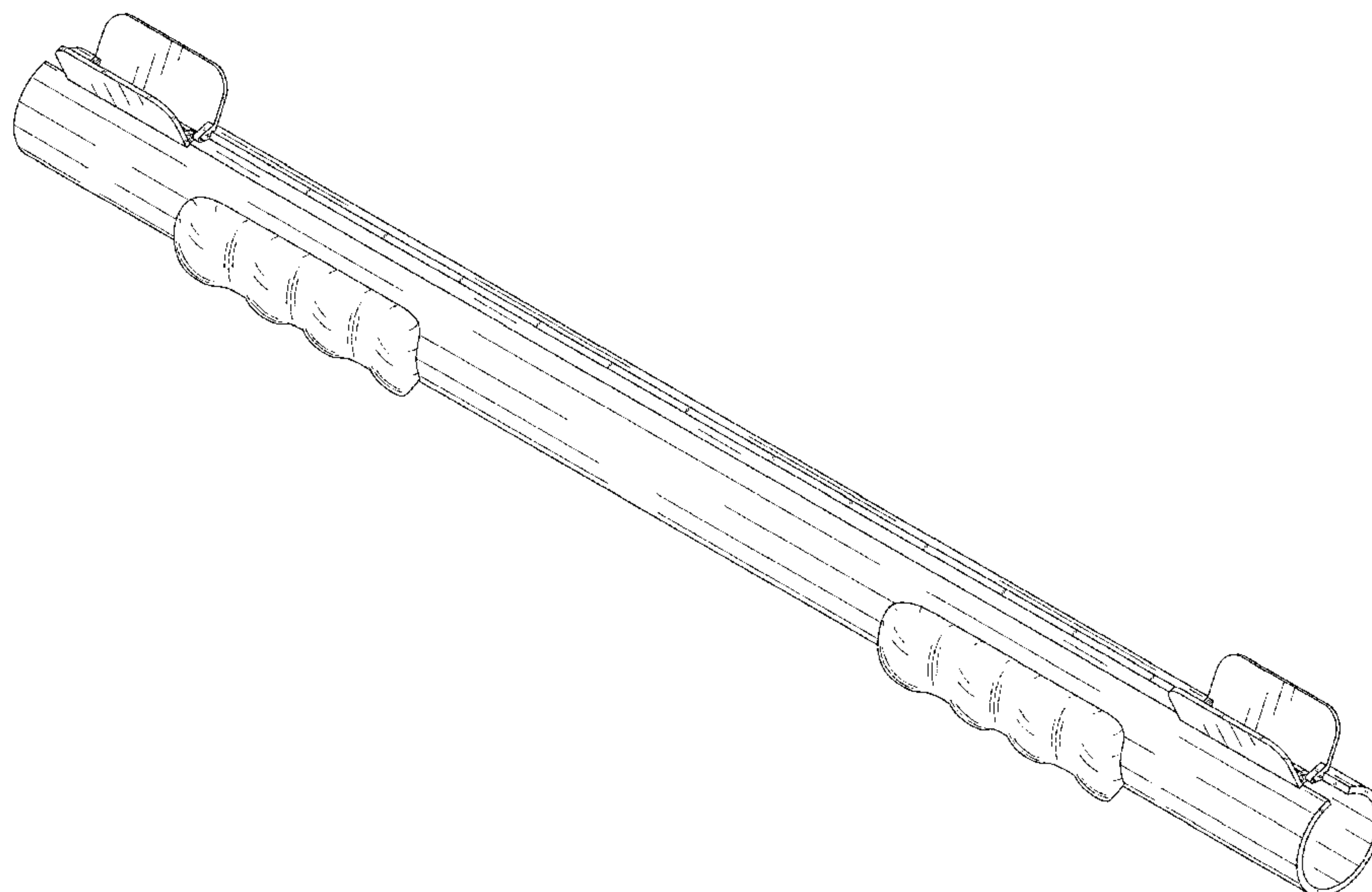

(56)

References Cited

U.S. PATENT DOCUMENTS

2009/0058024 A1* 3/2009 Cagan B62B 3/1468
280/33.991
2020/0223467 A1* 7/2020 Olbrich B62B 3/1472

* cited by examiner

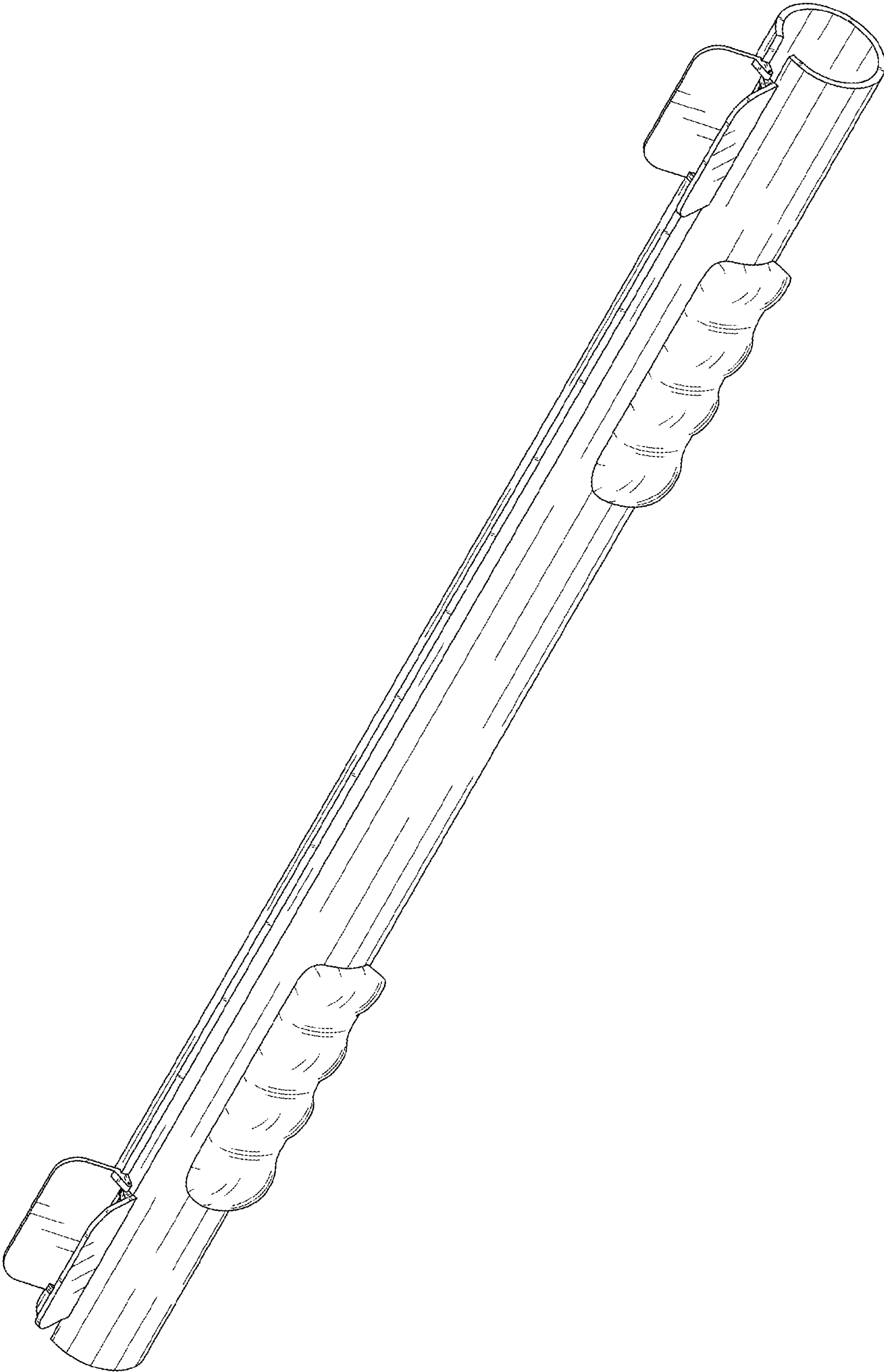

FIG. 1

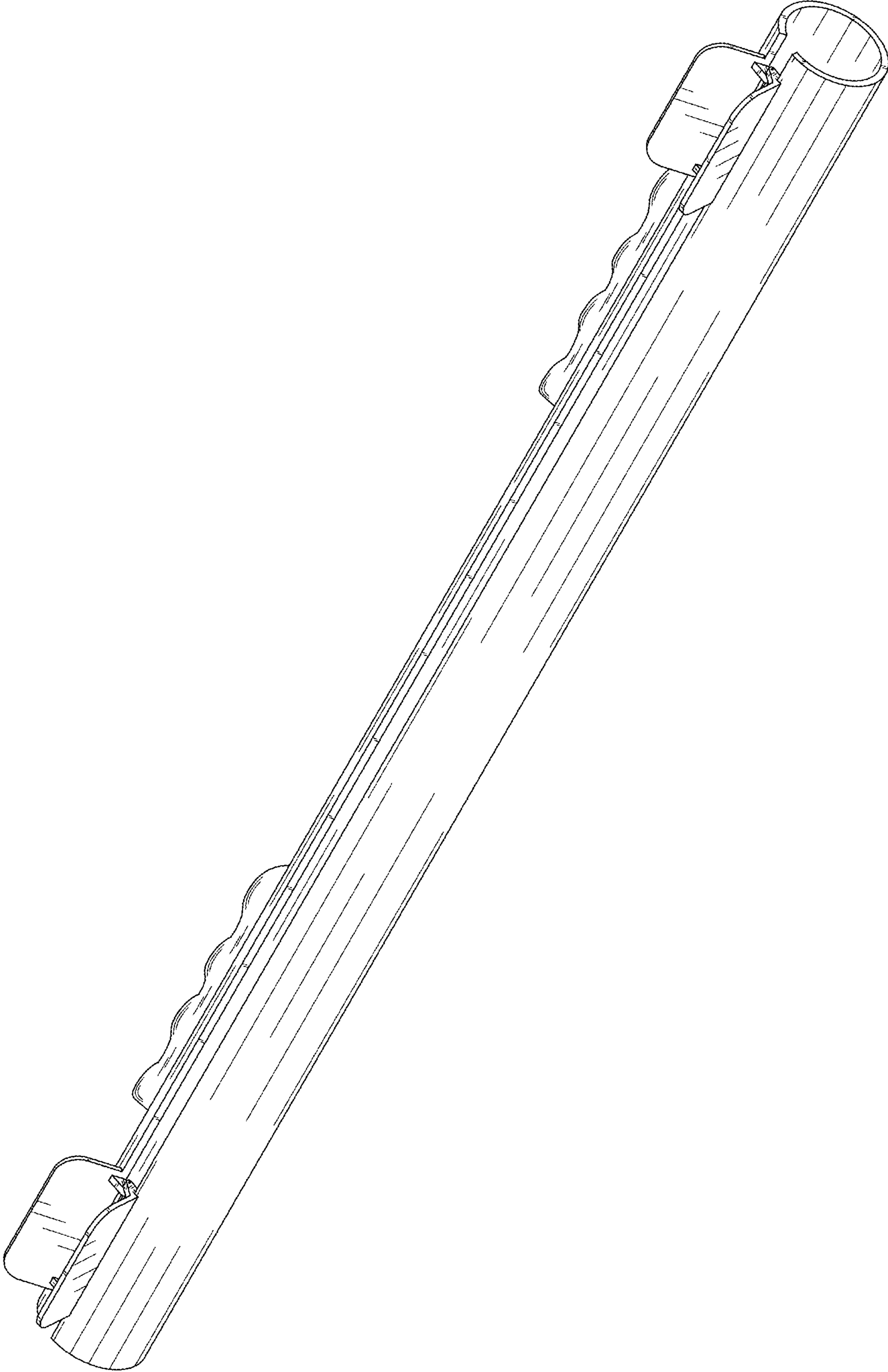

FIG. 2

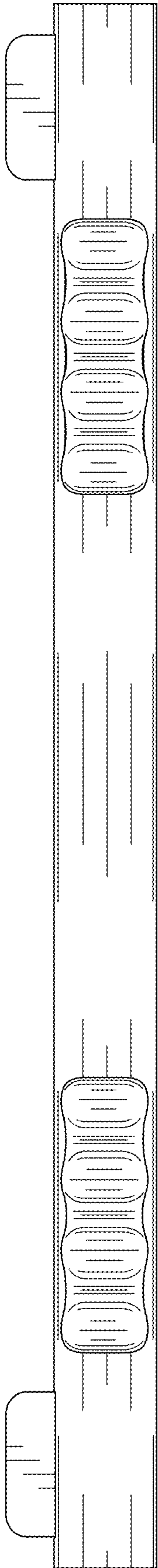

FIG. 3

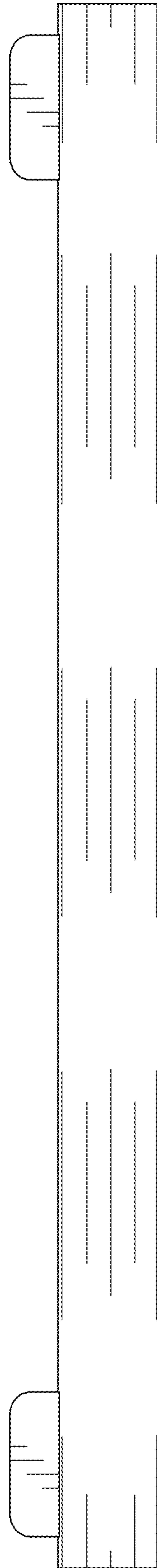

FIG. 4

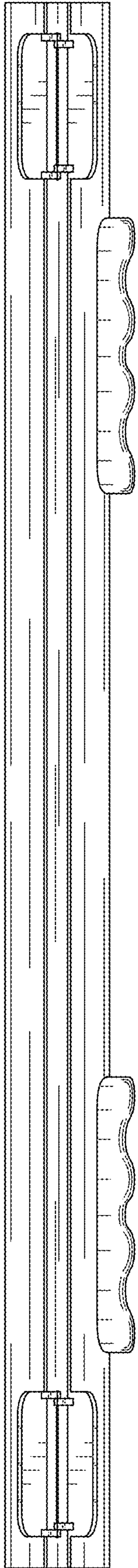

FIG. 5

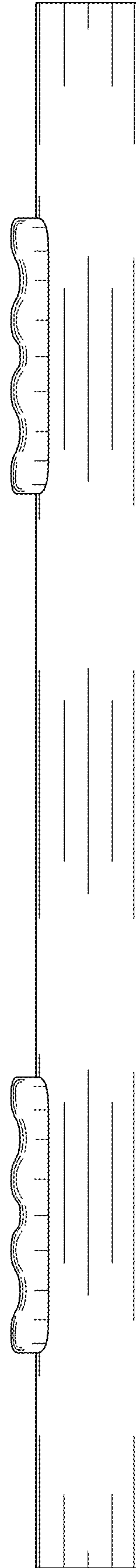

FIG. 6

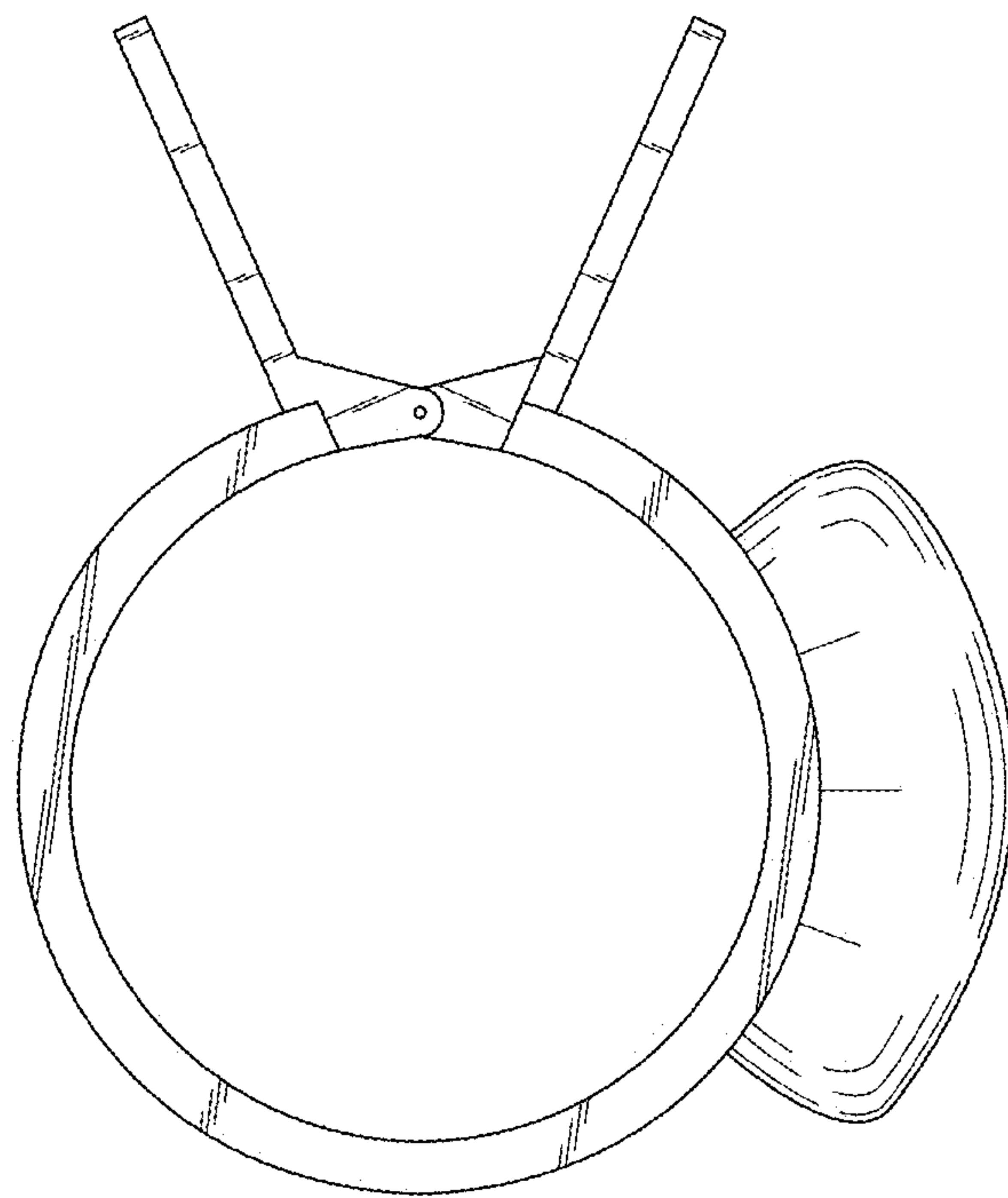

FIG. 7

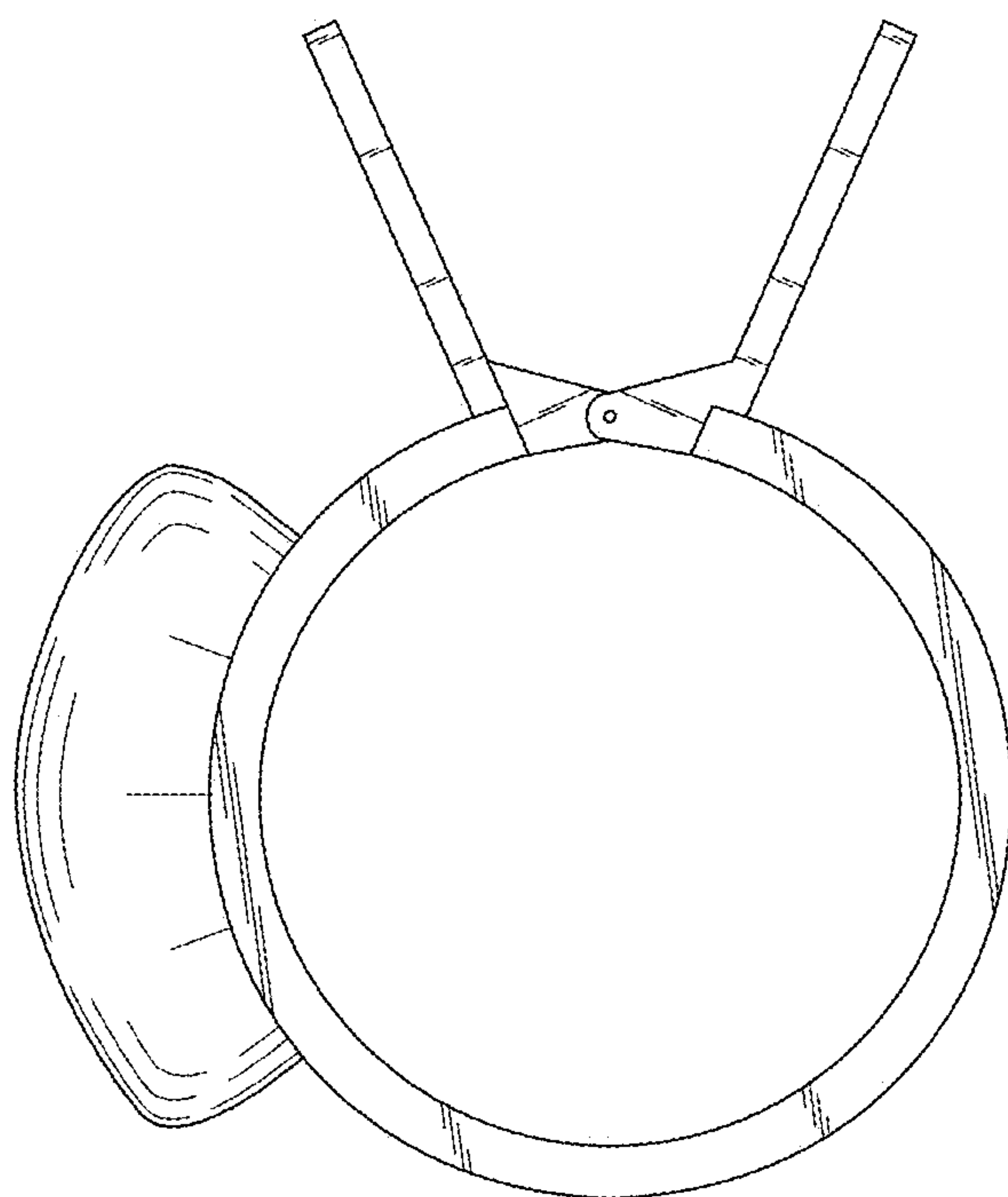

FIG. 8