



US00D940327S

(12) **United States Design Patent**
Lee et al.

(10) **Patent No.:** **US D940,327 S**
(45) **Date of Patent:** **** Jan. 4, 2022**

(54) **COMBINATION MEDICAL DEVICE
RECEIVER AND DISPLAY**

(71) Applicant: **DexCom, Inc.**, San Diego, CA (US)

(72) Inventors: **Young Woo Lee**, San Diego, CA (US);
Bobby Davis, San Diego, CA (US)

(73) Assignee: **DexCom, Inc.**, San Diego, CA (US)

(**) Term: **15 Years**

(21) Appl. No.: **29/718,612**

(22) Filed: **Dec. 26, 2019**

(51) **LOC (13) Cl.** **24-01**

(52) **U.S. Cl.**

USPC **D24/169**; D24/186

(58) **Field of Classification Search**

USPC D24/107, 164, 165-169, 186, 187;
D10/75, 70, 98; D14/341, 344, 138 R,
D14/138 AA

(Continued)

(56) **References Cited**

U.S. PATENT DOCUMENTS

D545,438 S * 6/2007 Huang D24/186
D582,043 S * 12/2008 Koike D24/165

(Continued)

OTHER PUBLICATIONS

The Rationale for Continuous Glucose Monitoring-based Diabetes Treatment Decisions and Non-adjunctive Continuous Glucose Monitoring Use. *European Endocrinology*. Mar. 15, 2016.*

Primary Examiner — Anhdao Doan

(74) *Attorney, Agent, or Firm* — Knobbe Martens Olson & Bear LLP

(57) **CLAIM**

The ornamental design for a combination medical device receiver and display, as shown and described.

DESCRIPTION

FIG. 1 is an elevated perspective view of an embodiment of a combination medical device receiver and display; FIG. 2 is a front view of the combination medical device receiver and display shown in FIG. 1; FIG. 3 is a rear view of the combination medical device receiver and display shown in FIG. 1; FIG. 4 is a left side view of the combination medical device receiver and display shown in FIG. 1; FIG. 5 is a right side view of the combination medical device receiver and display shown in FIG. 1; FIG. 6 is a top view of the combination medical device receiver and display shown in FIG. 1; FIG. 7 is a bottom view of the combination medical device receiver and display shown in FIG. 1; FIG. 8 is a front view of a second embodiment of a combination medical device receiver and display, having rear, left side, right side, top, and bottom views as shown in FIGS. 3-7, respectively. FIG. 9 is an elevated perspective view of a third embodiment of a combination medical device receiver and display; FIG. 10 is a front view of the combination medical device receiver and display shown in FIG. 9; FIG. 11 is a rear view of the combination medical device receiver and display shown in FIG. 9; FIG. 12 is a left side view of the combination medical device receiver and display shown in FIG. 9; FIG. 13 is a right side view of the combination medical device receiver and display shown in FIG. 9; FIG. 14 is a top view of the combination medical device receiver and display shown in FIG. 9; FIG. 15 is a bottom view of the combination medical device receiver and display shown in FIG. 9; FIG. 16 is a front view of a fourth embodiment of a combination medical device receiver and display, having rear, left side, right side, top, and bottom views as shown in FIGS. 11-15, respectively.

(Continued)

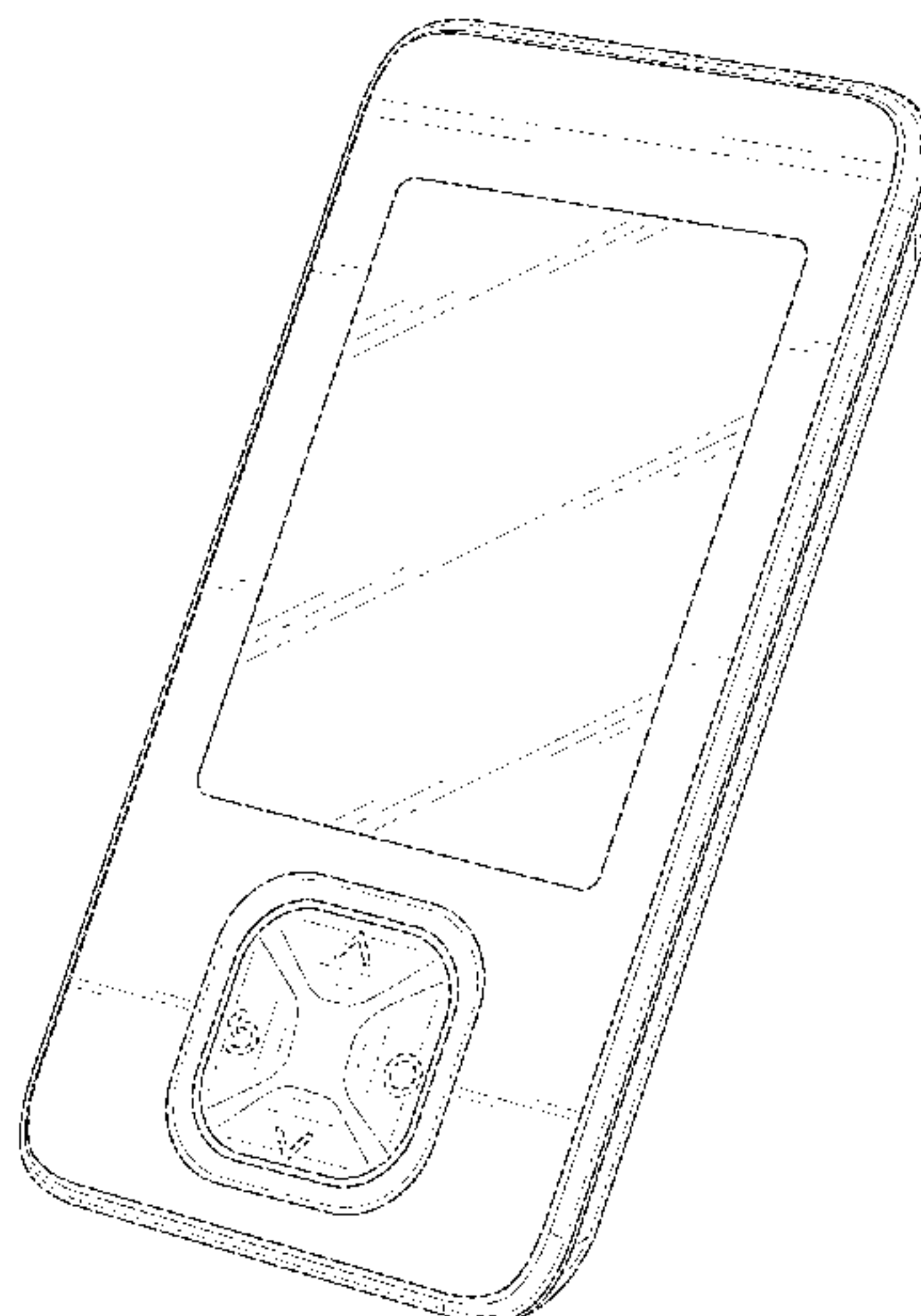

FIG. 17 is an elevated perspective view of a fifth embodiment of a combination medical device receiver and display; FIG. 18 is a front view of the combination medical device receiver and display shown in FIG. 17;

FIG. 19 is a rear view of the combination medical device receiver and display shown in FIG. 17;

FIG. 20 is a left side view of the combination medical device receiver and display shown in FIG. 17;

FIG. 21 is a right side view of the combination medical device receiver and display shown in FIG. 17;

FIG. 22 is a top view of the combination medical device receiver and display shown in FIG. 17;

FIG. 23 is a bottom view of the combination medical device receiver and display shown in FIG. 17; and,

FIG. 24 is a front view of a sixth embodiment of a combination medical device receiver and display, having rear, left side, right side, top, and bottom views as shown in FIGS. 19-23, respectively.

The broken lines depict portions of the combination medical device receiver and display that form no part of the claimed design.

1 Claim, 24 Drawing Sheets

(58) **Field of Classification Search**

CPC A61B 5/14532; A61B 2560/0412; A61B 2560/0443; A61B 2560/0462; G06F 1/1626

See application file for complete search history.

(56) **References Cited**

U.S. PATENT DOCUMENTS

D621,515	S *	8/2010	Chua	D24/186
8,010,174	B2	8/2011	Goode, Jr. et al.	
D659,836	S *	5/2012	Bensch	D24/167
D679,274	S *	4/2013	Canizares	D14/341
D696,404	S *	12/2013	Golnik	D24/169
D723,695	S *	3/2015	Chung	D24/169
9,041,730	B2	5/2015	Johnson et al.	
D745,167	S *	12/2015	Canas	D24/167
D752,229	S *	3/2016	Chen	D24/165
D764,060	S *	8/2016	Singh	D24/167
D793,983	S *	8/2017	Xu	D14/138 AA
D794,803	S	8/2017	Thom	
D890,346	S *	7/2020	Lam	D24/167
D893,735	S *	8/2020	Yin	D24/200

* cited by examiner

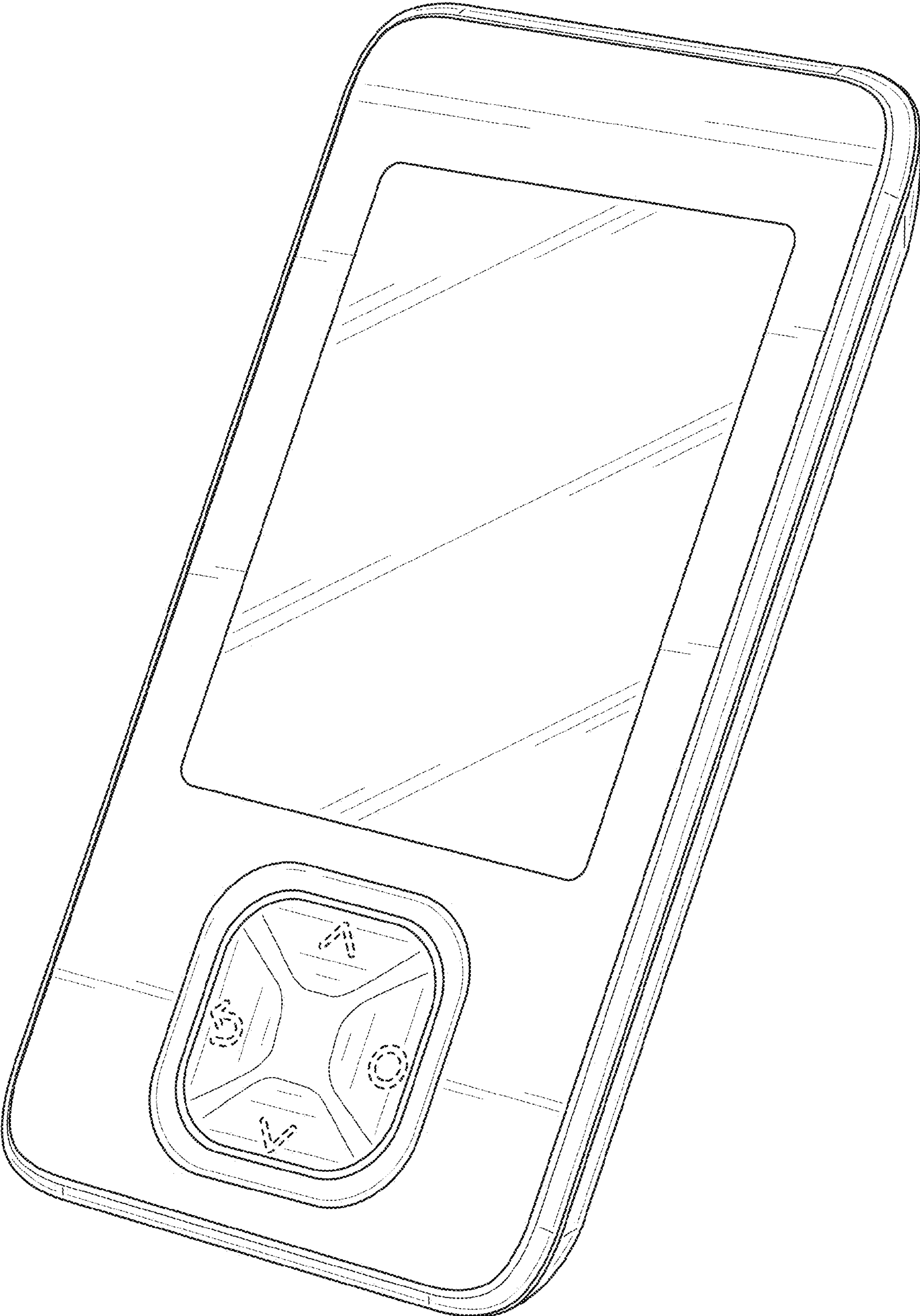

FIG. 1

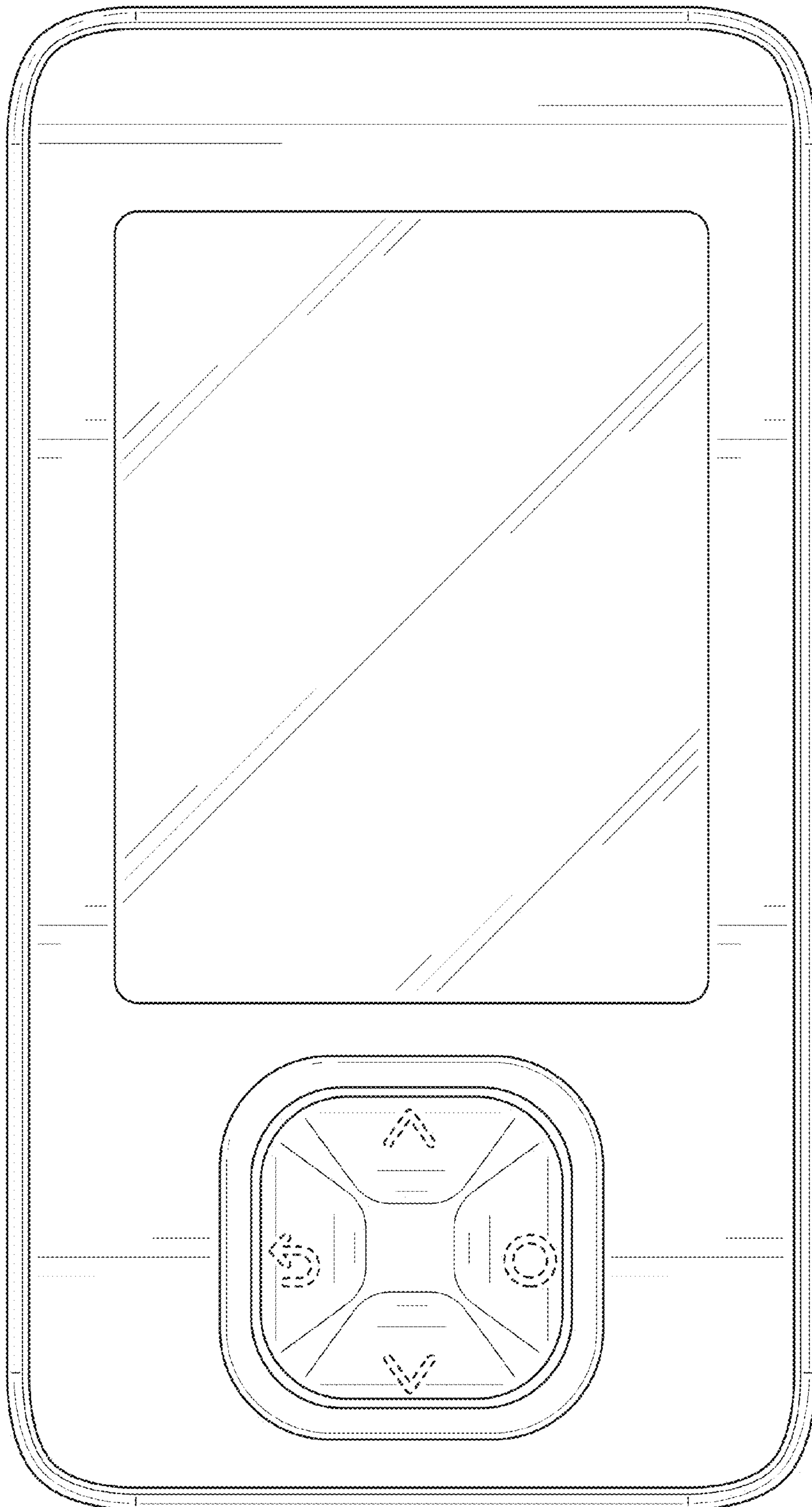

FIG. 2

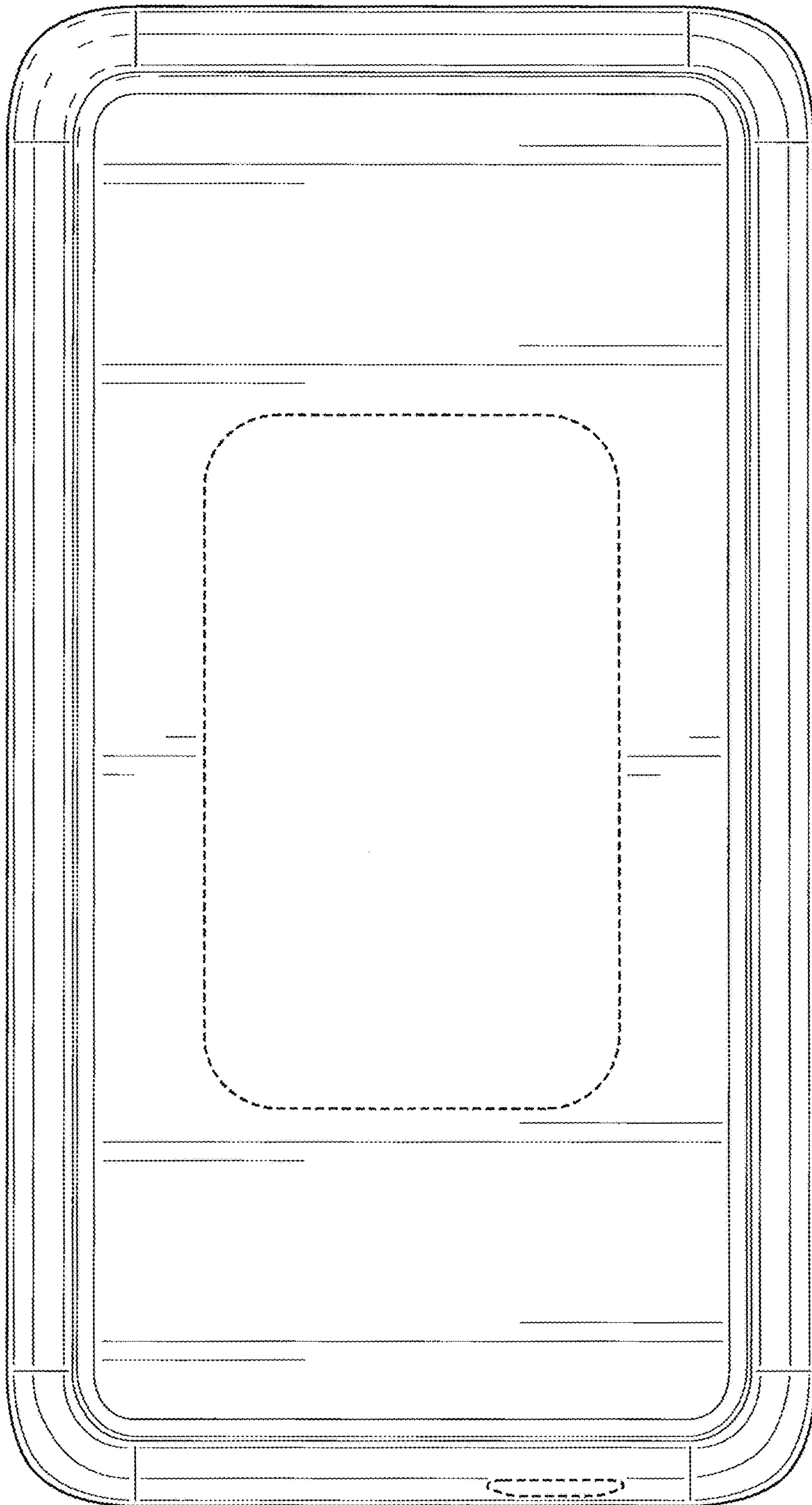

FIG. 3

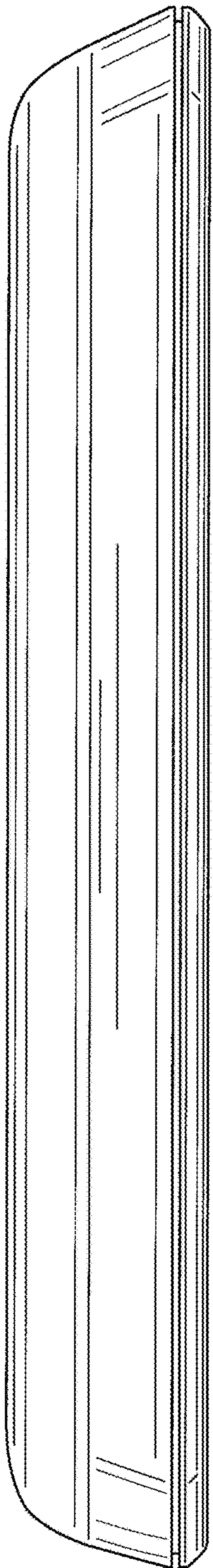

FIG. 4

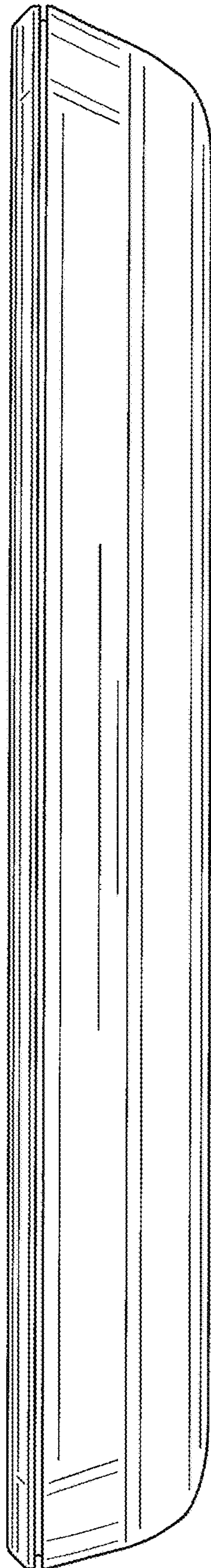

FIG. 5

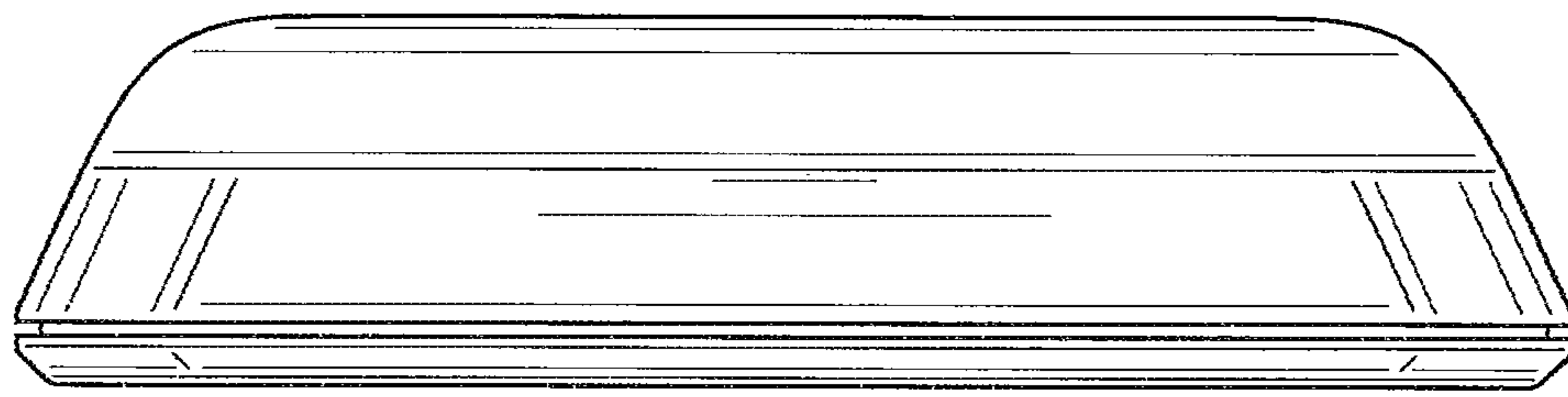

FIG. 6

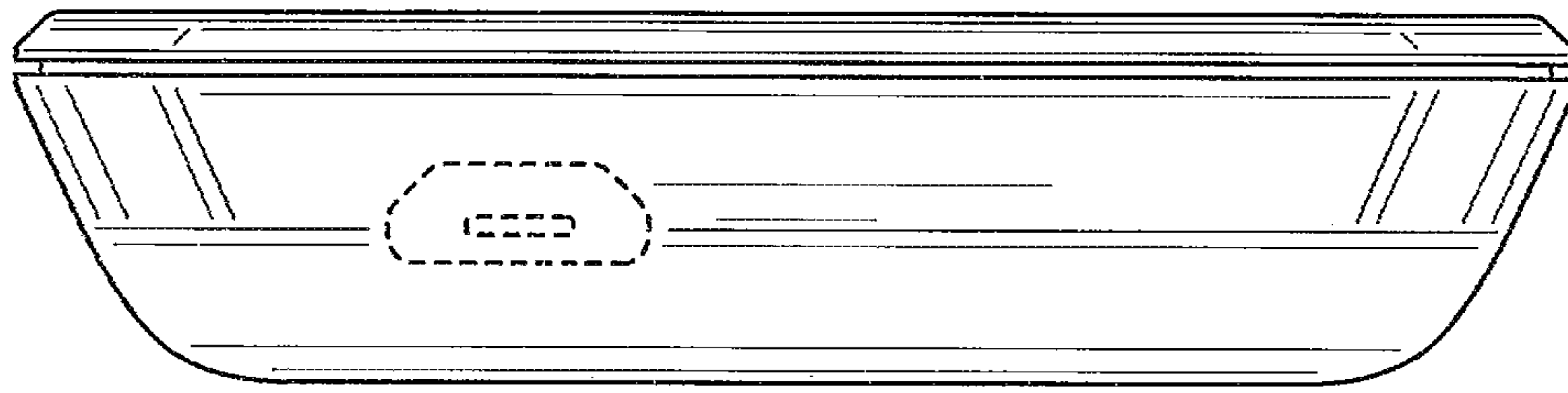

FIG. 7

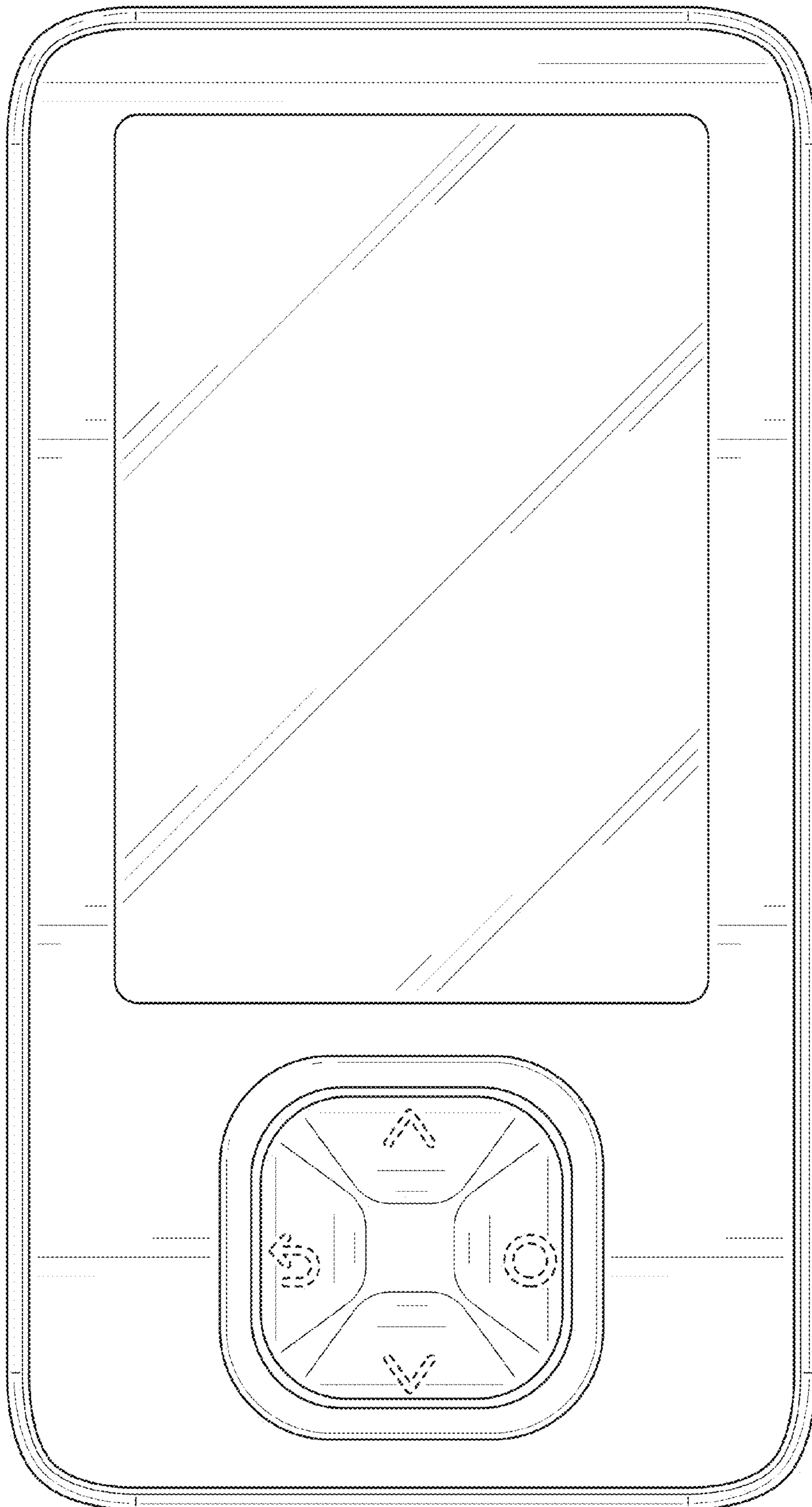

FIG. 8

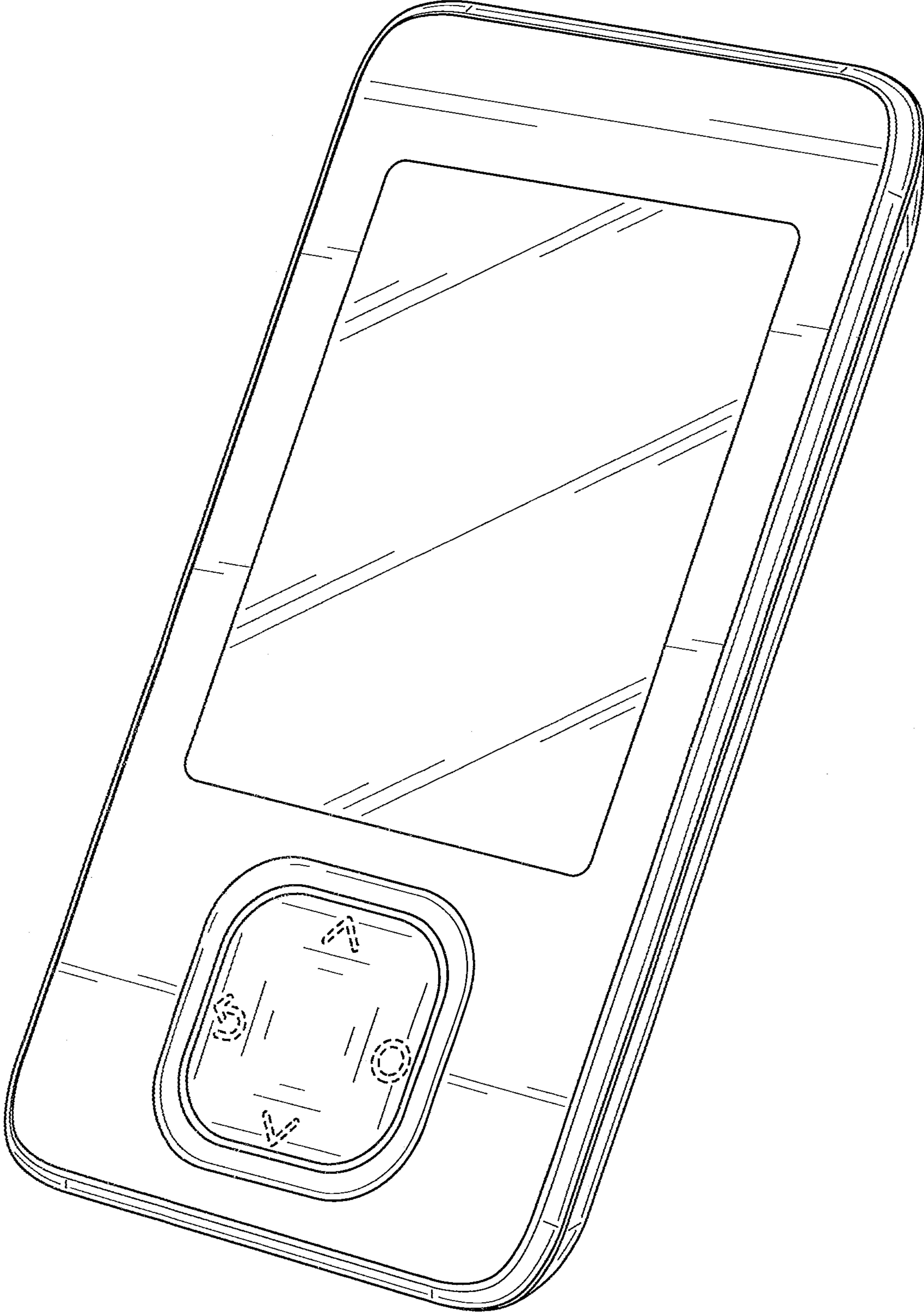

FIG. 9

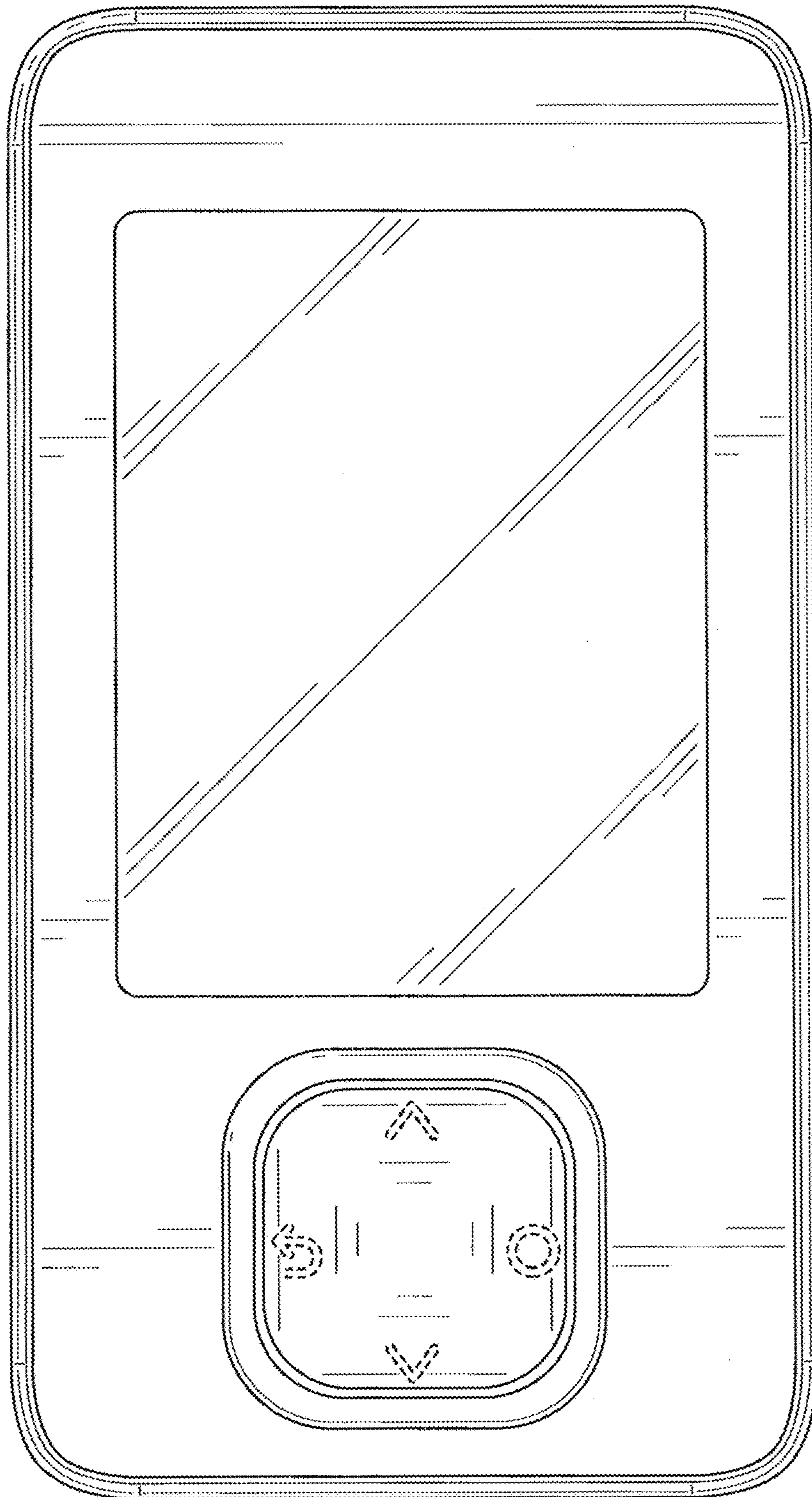

FIG. 10

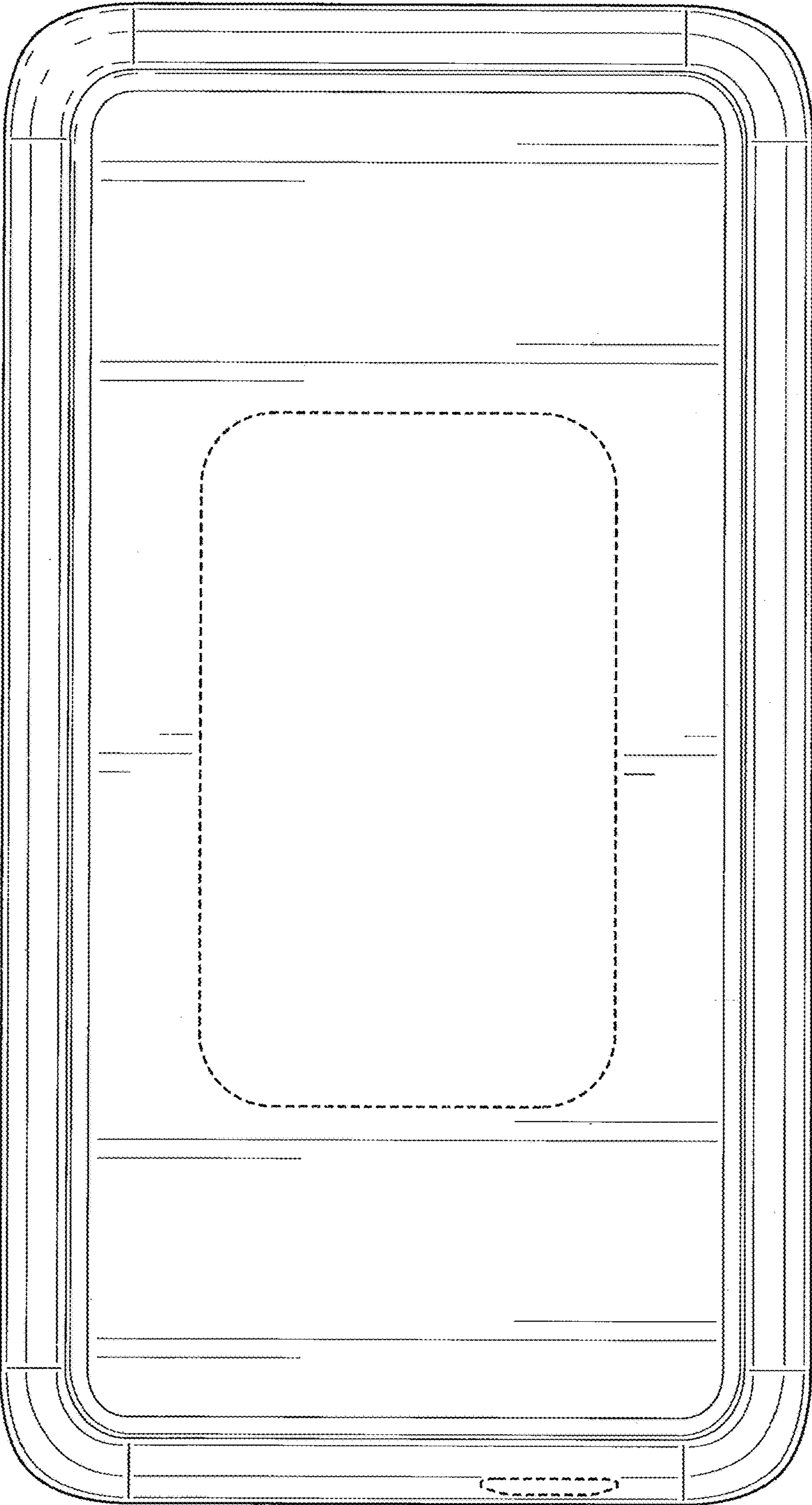

FIG. 11

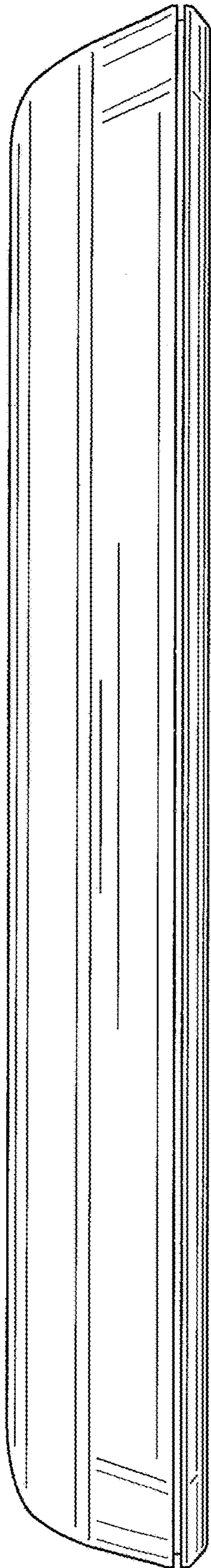

FIG. 12

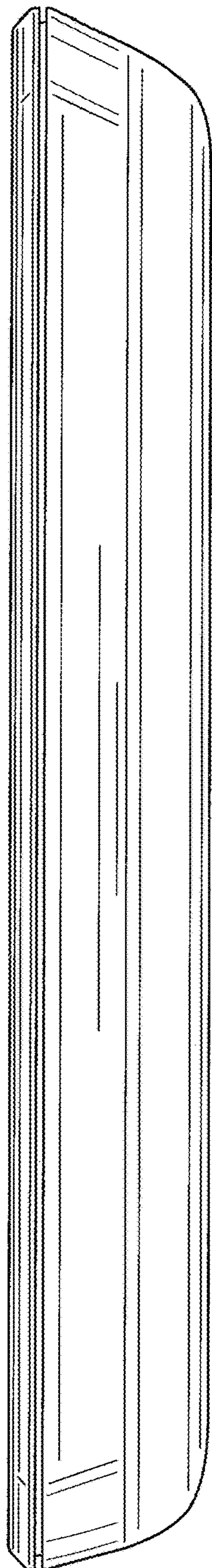

FIG. 13

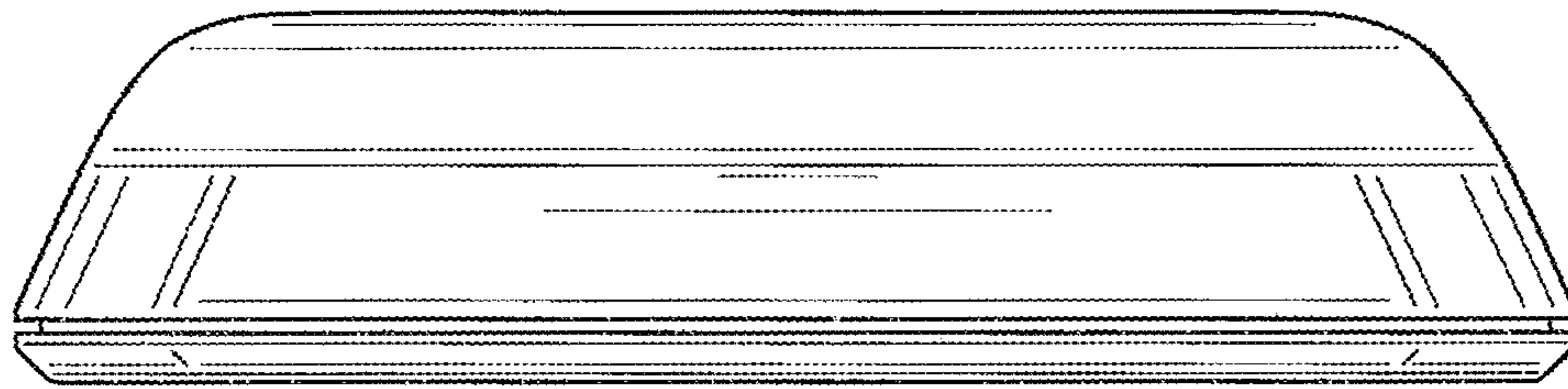

FIG. 14

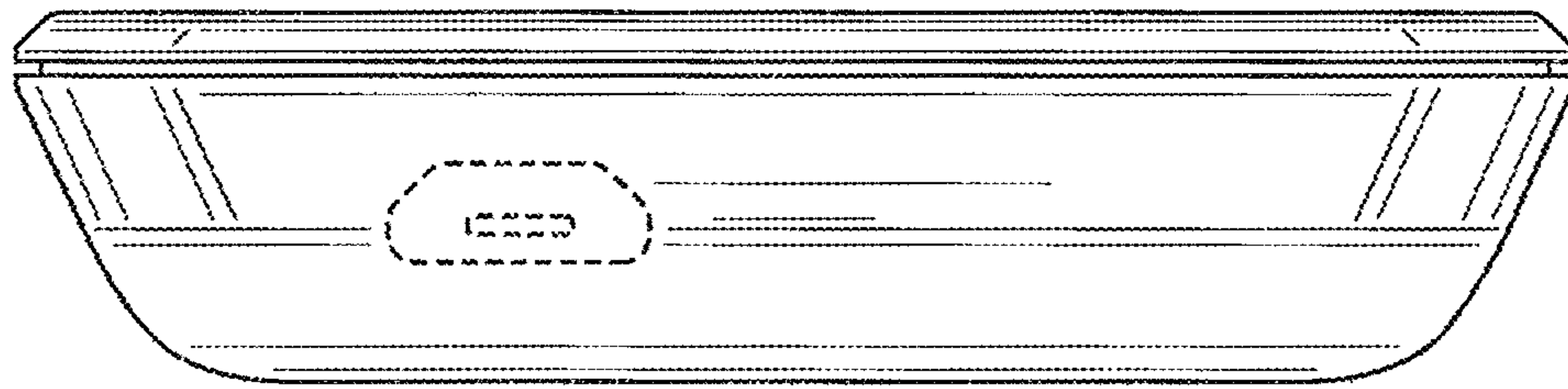

FIG. 15

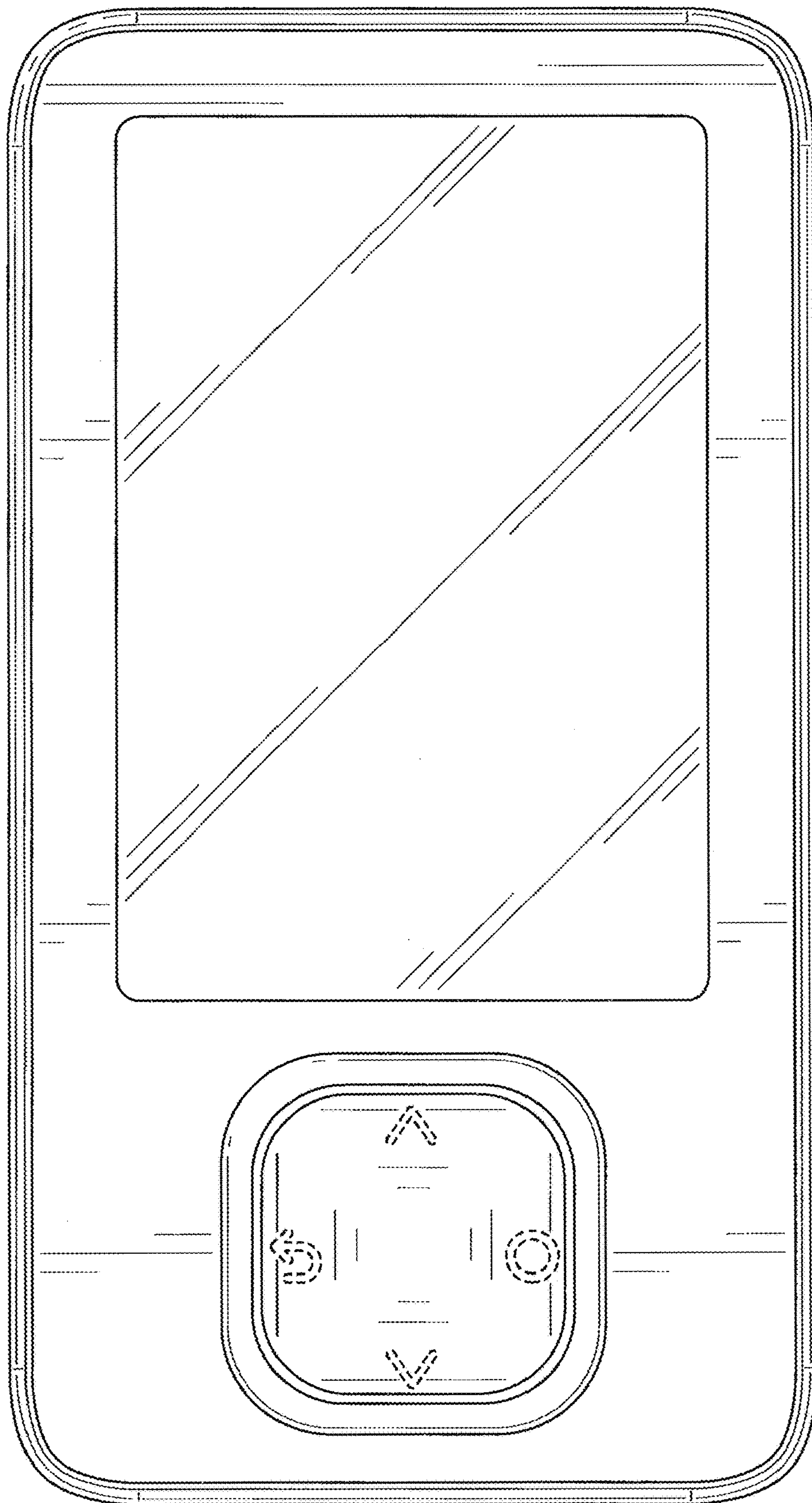

FIG. 16

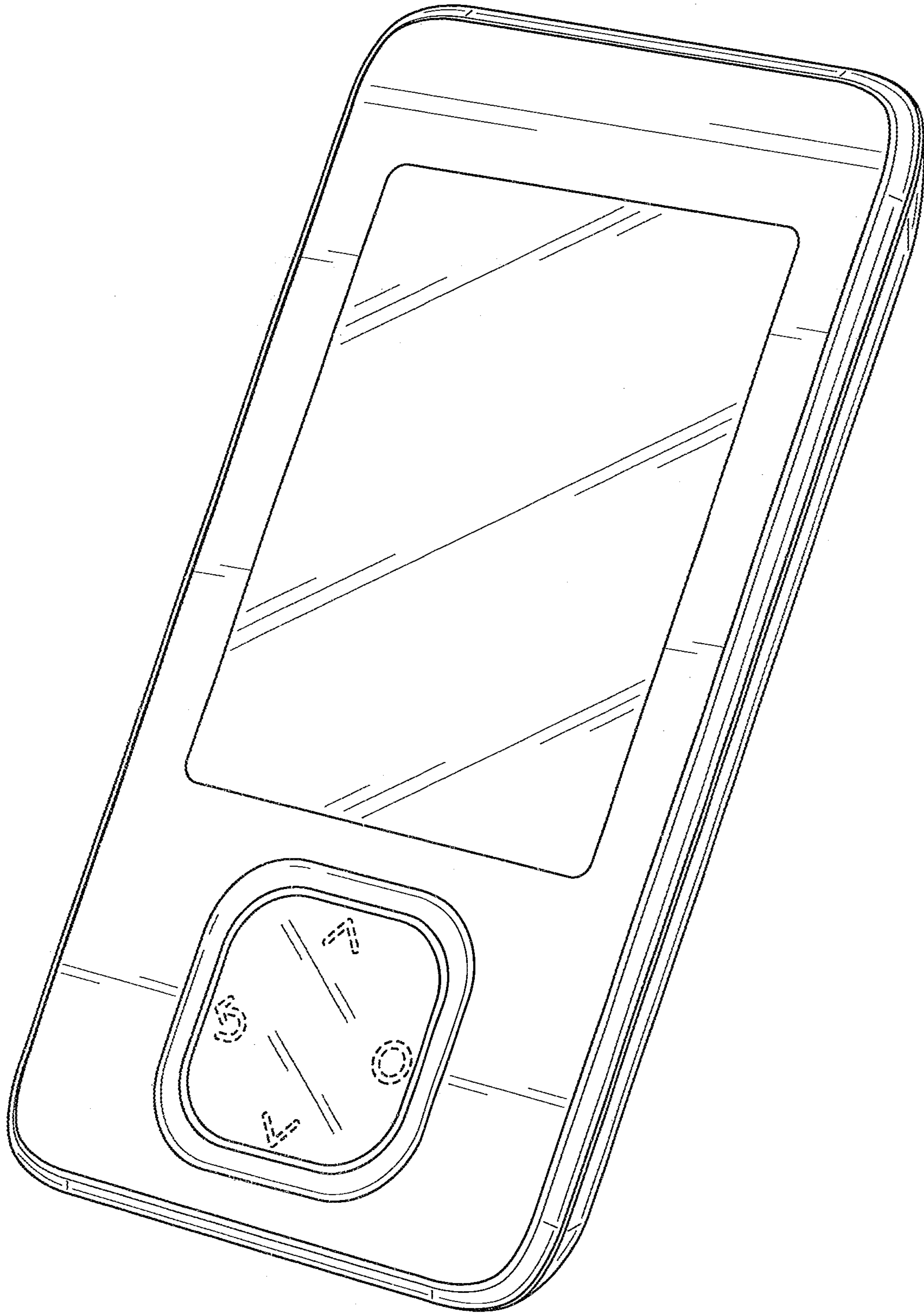

FIG. 17

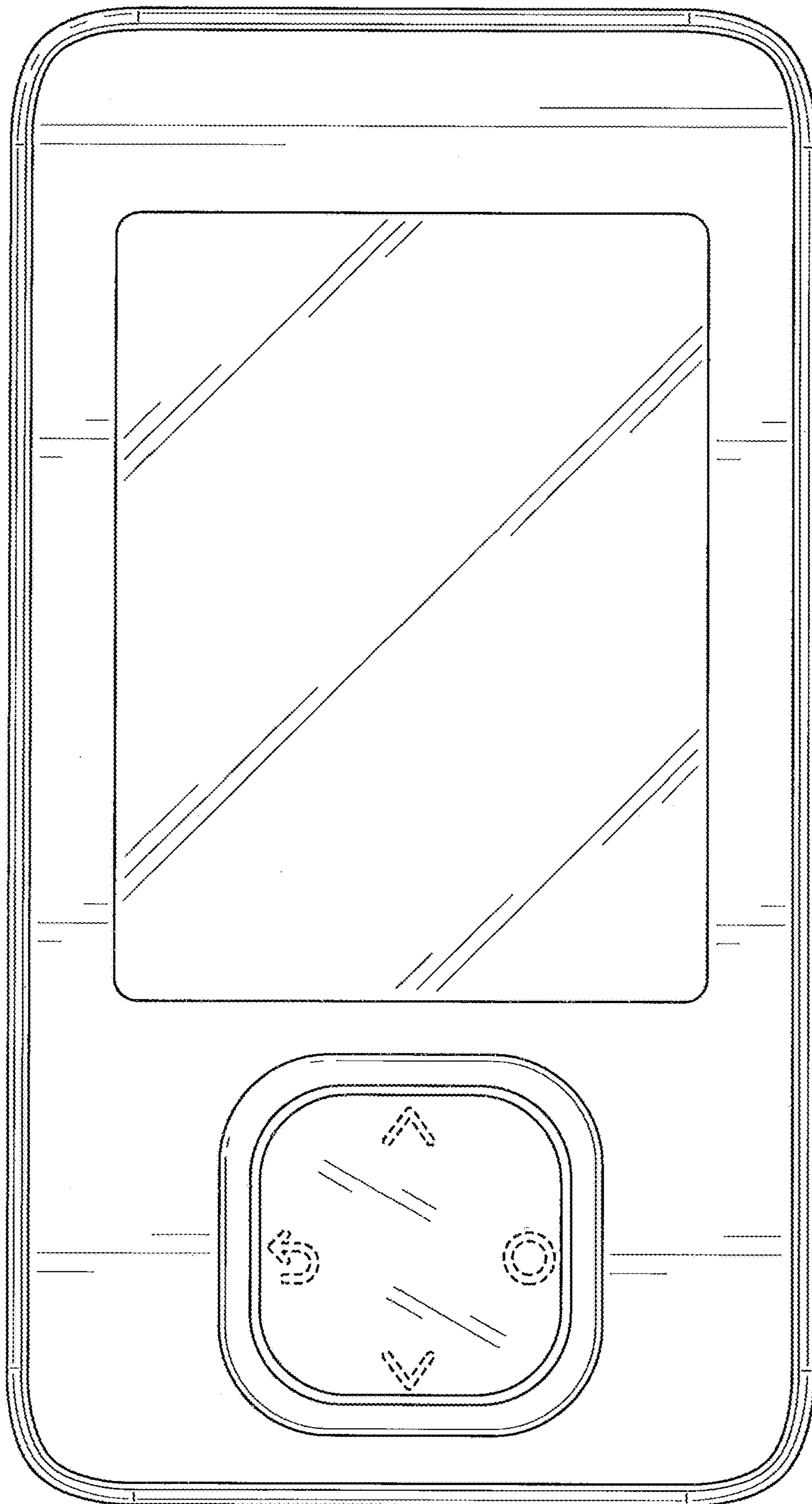

FIG. 18

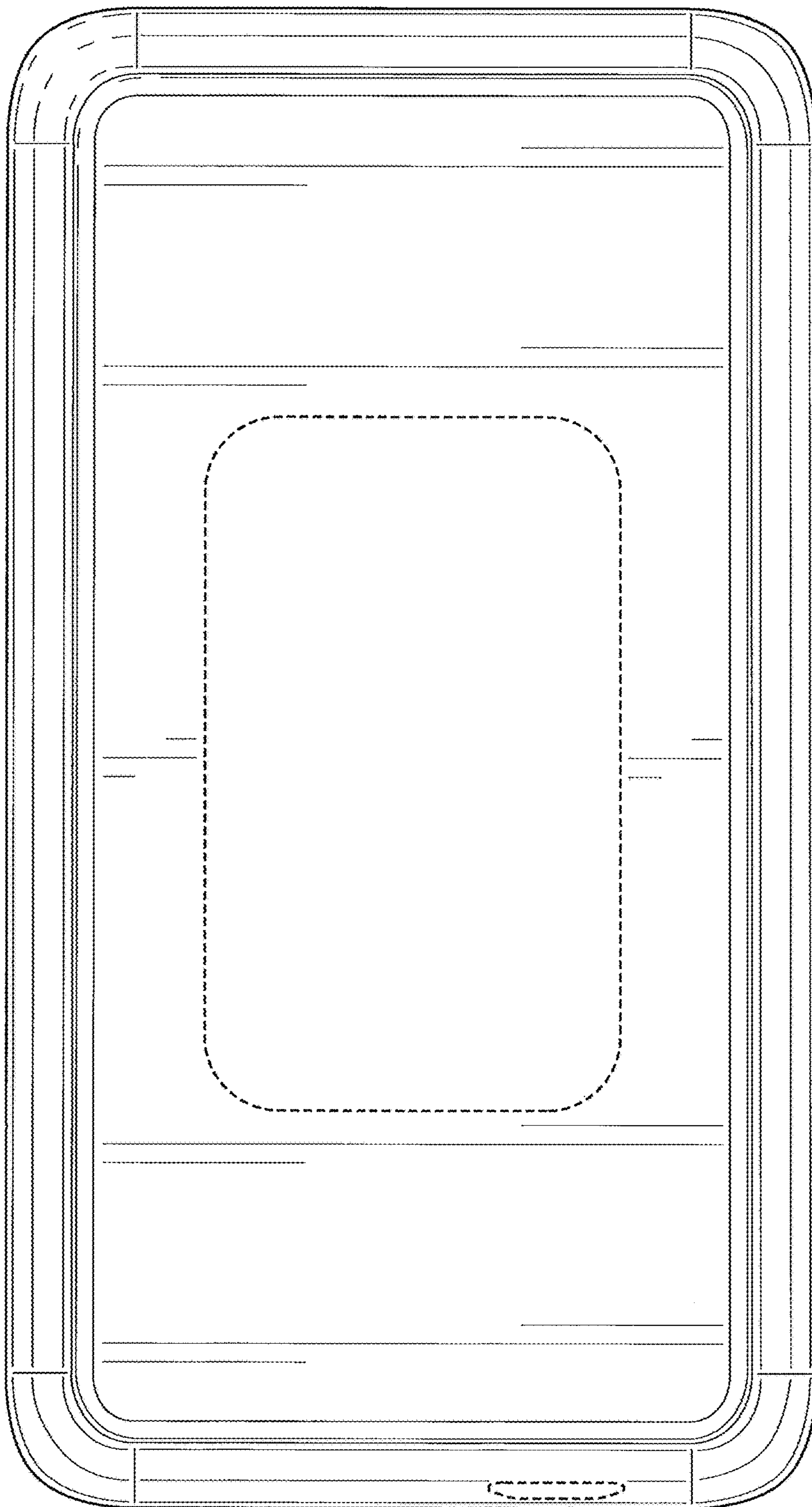

FIG. 19

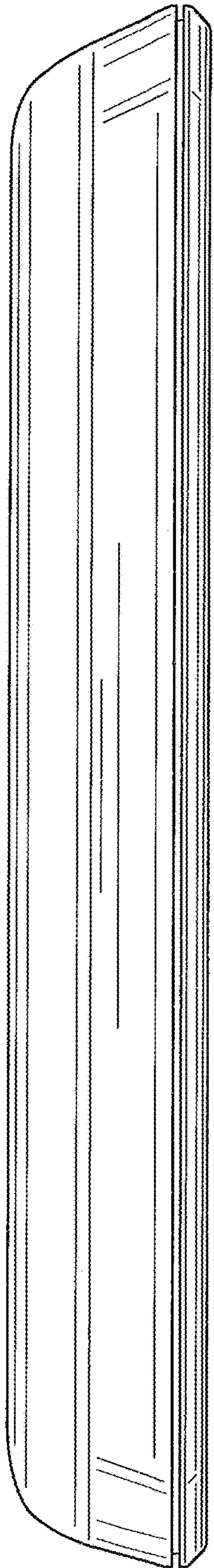

FIG. 20

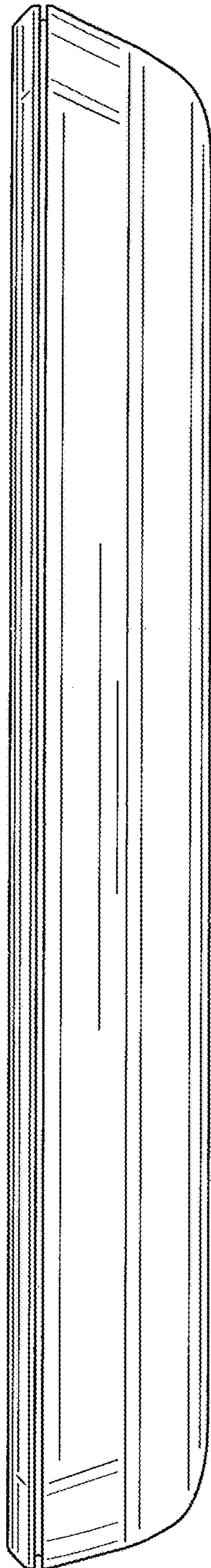

FIG. 21

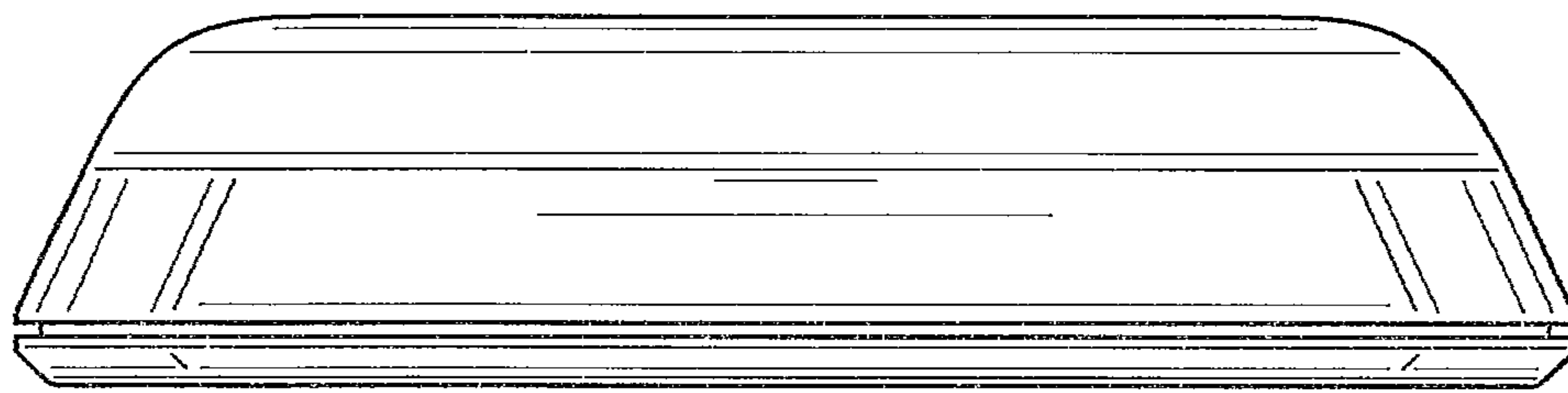

FIG. 22

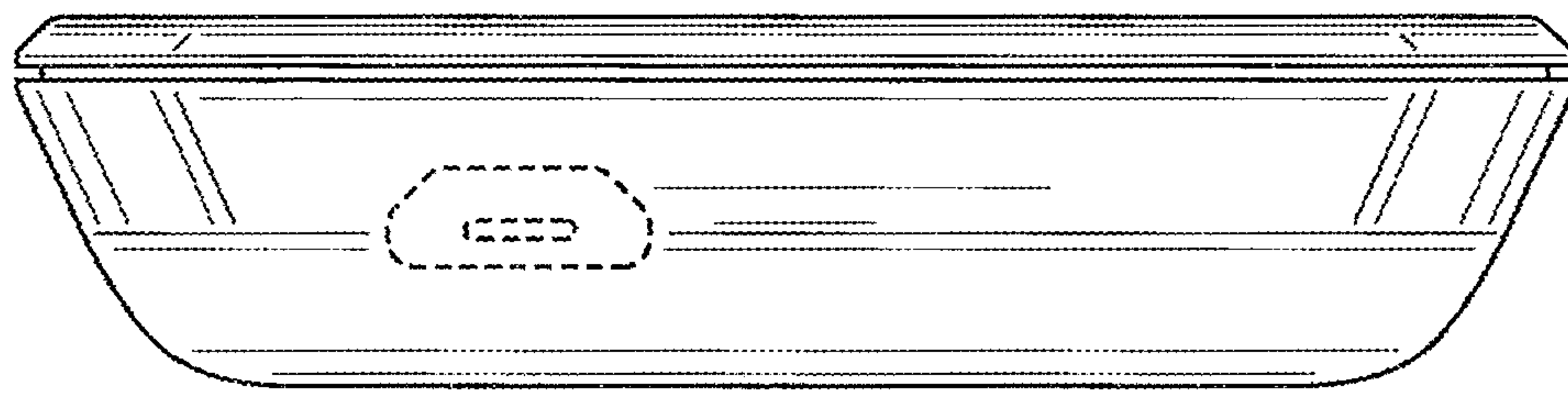

FIG. 23

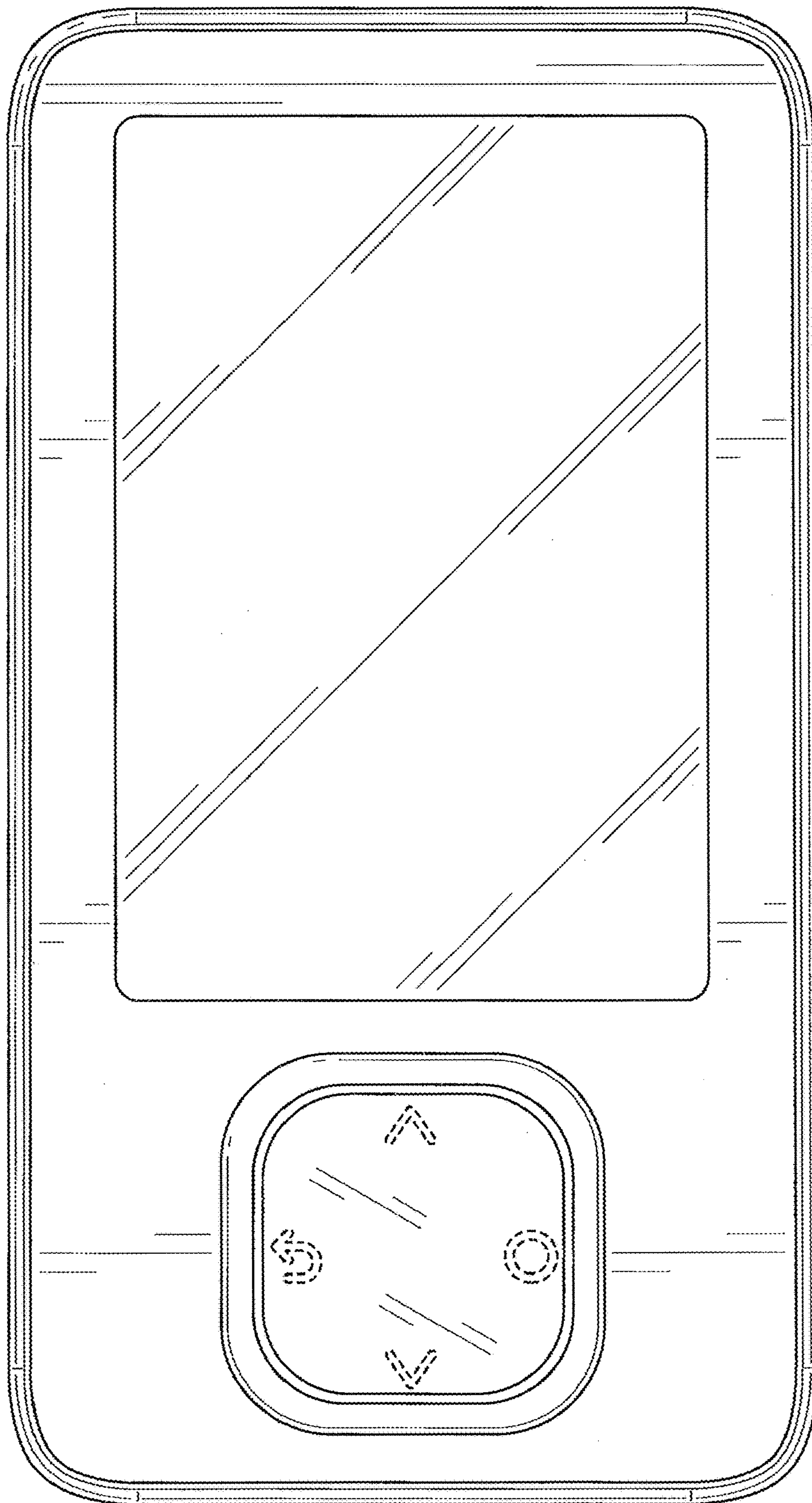

FIG. 24