



US00D940257S

(12) **United States Design Patent**  
**Kravchenko**

(10) **Patent No.:** **US D940,257 S**  
(45) **Date of Patent:** **\*\* Jan. 4, 2022**

- (54) **INVERTED-HEART-SHAPED DUMBBELL**
- (71) Applicant: **Alina Kravchenko**, Houston, TX (US)
- (72) Inventor: **Alina Kravchenko**, Houston, TX (US)
- (73) Assignee: **Alina Kravchenko**, Houston, TX (US)
- (\*\*) Term: **15 Years**
- (21) Appl. No.: **29/729,635**
- (22) Filed: **Mar. 28, 2020**
- (51) **LOC (13) Cl.** ..... **21-02**
- (52) **U.S. Cl.**  
USPC ..... **D21/681**
- (58) **Field of Classification Search**  
USPC ..... D21/694, 662, 684, 675, 677, 681, 807,  
D21/680  
See application file for complete search history.

D663,365	S	*	7/2012	Vinther	.....	D21/350
D699,120	S	*	2/2014	Kraai	.....	D9/629
D722,206	S	*	2/2015	Gavish	.....	D29/100
D731,010	S	*	6/2015	Levitt	.....	D21/681
D752,160	S		3/2016	Widerman		
D773,568	S	*	12/2016	De Marchis	.....	D21/681
10,016,649	B2	*	7/2018	Widerman	.....	A63B 21/285
D837,383	S	*	1/2019	Wigal	.....	D24/180
D844,483	S	*	4/2019	Tuennemann	.....	D11/149
D867,505	S	*	11/2019	Quinlan	.....	D21/776
D897,234	S	*	9/2020	Peters	.....	D11/149
2011/0098159	A1	*	4/2011	Wiseman	.....	A63B 21/072 482/108
2017/0000587	A1	*	1/2017	Wigal	.....	A61C 7/125
2018/0186070	A1	*	7/2018	Yun	.....	B29C 64/321

(56) **References Cited**  
U.S. PATENT DOCUMENTS

D32,665	S	*	5/1900	Stevens	.....	D24/214
2,169,382	A	*	8/1939	Di Domenico	.....	B65D 5/32 229/116.2
3,115,338	A	*	12/1963	Acs	.....	A63B 21/4035 482/141
D269,789	S	*	7/1983	Monson	.....	D14/190
D273,030	S	*	3/1984	Anderson	.....	D21/682
5,897,471	A	*	4/1999	Multanen	.....	A63B 21/045 482/44
D460,687	S	*	7/2002	Weinstock	.....	D9/629
D476,130	S	*	6/2003	Joy	.....	D99/5
D551,978	S	*	10/2007	Daniels	.....	D9/456
D564,935	S	*	3/2008	Steshik	.....	D11/91
D577,385	S	*	9/2008	Sand	.....	D19/91
7,438,512	B2	*	10/2008	Jakuszeski	.....	F16B 2/065 411/389
7,458,921	B2	*	12/2008	Hallar	.....	A63B 21/0726 482/106

**OTHER PUBLICATIONS**

Hangzhou Yizhi Sporting Store, "Gift for your girlfriend, heart-shaped dumbbell gym equipment", <https://www.aliexpress.com/item/4000467134960.html> (accessed and archived Mar. 28, 2020).

\* cited by examiner

*Primary Examiner* — Khawaja Anwar  
*Assistant Examiner* — Julice Seung Eun Oum  
(74) *Attorney, Agent, or Firm* — Scot Fagerland

(57) **CLAIM**

I claim the ornamental design for an inverted-heart-shaped dumbbell, as shown and described.

**DESCRIPTION**

FIG. 1 is an upper perspective view.  
FIG. 2 is a lower perspective view.  
FIG. 3 is the front view, which is identical to the rear view.  
FIG. 4 is the left view, which is identical to the right view.  
FIG. 5 is the top view; and,  
FIG. 6 is the bottom view.

**1 Claim, 6 Drawing Sheets**

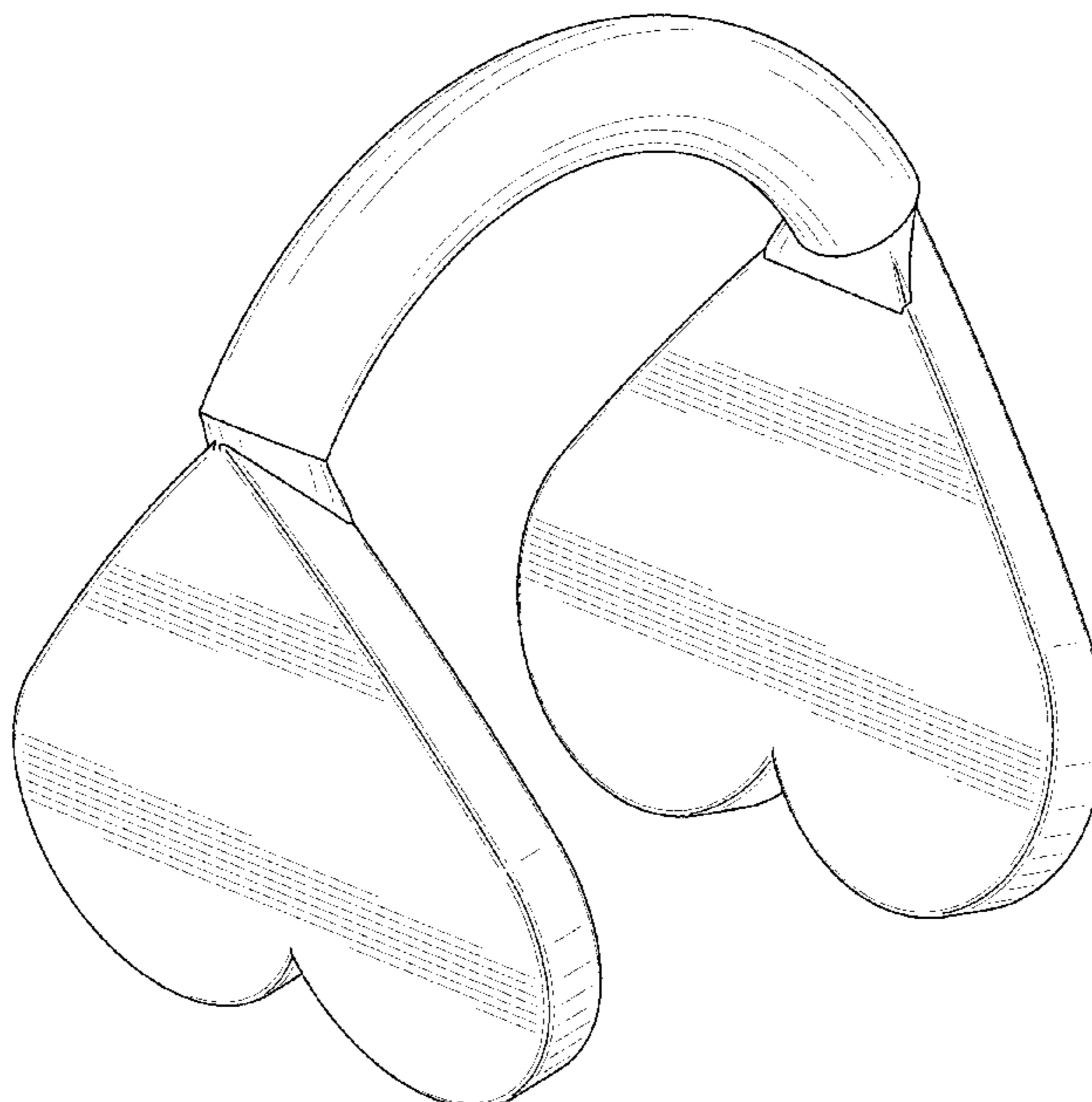

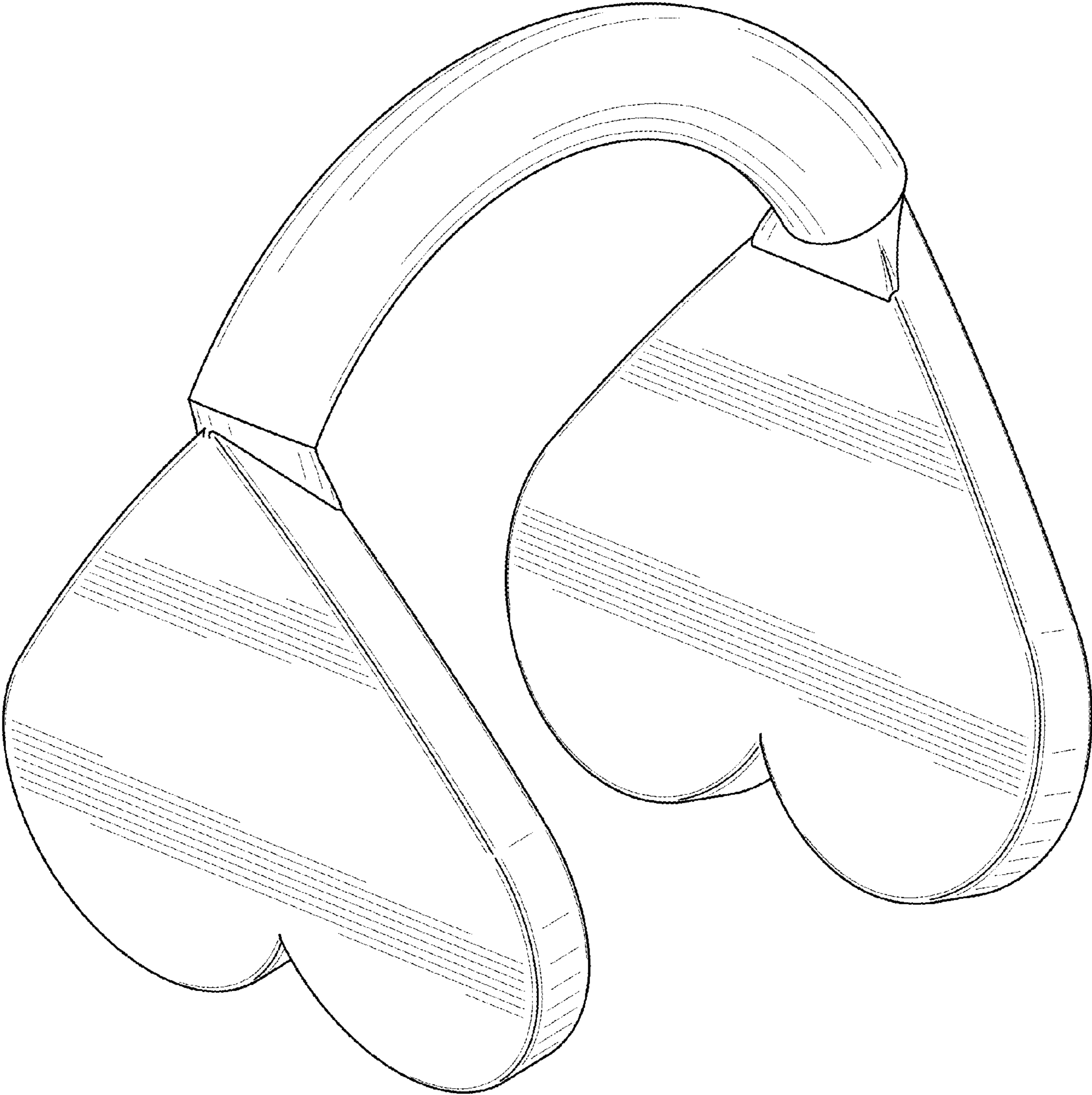

FIG. 1

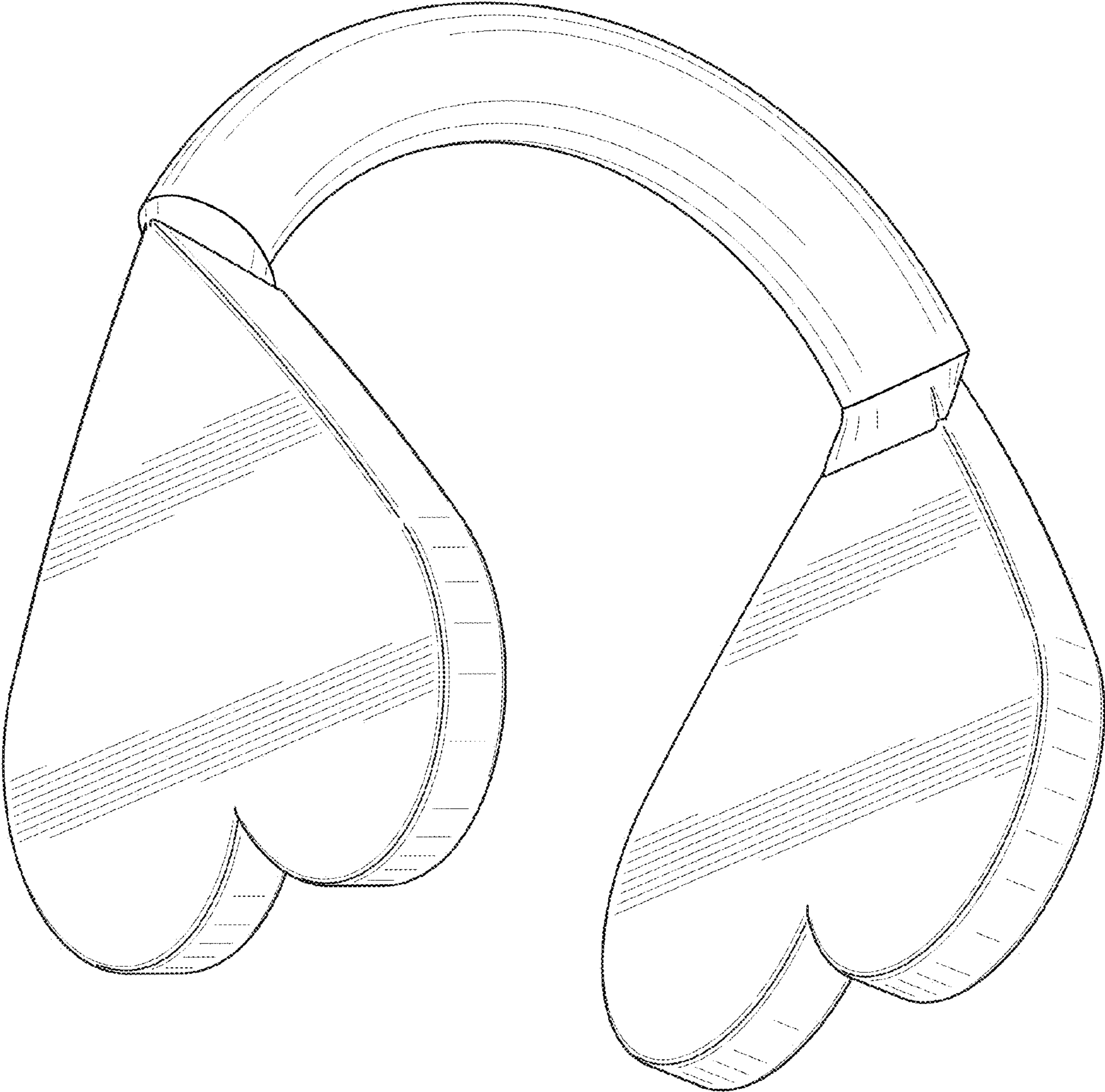

FIG. 2

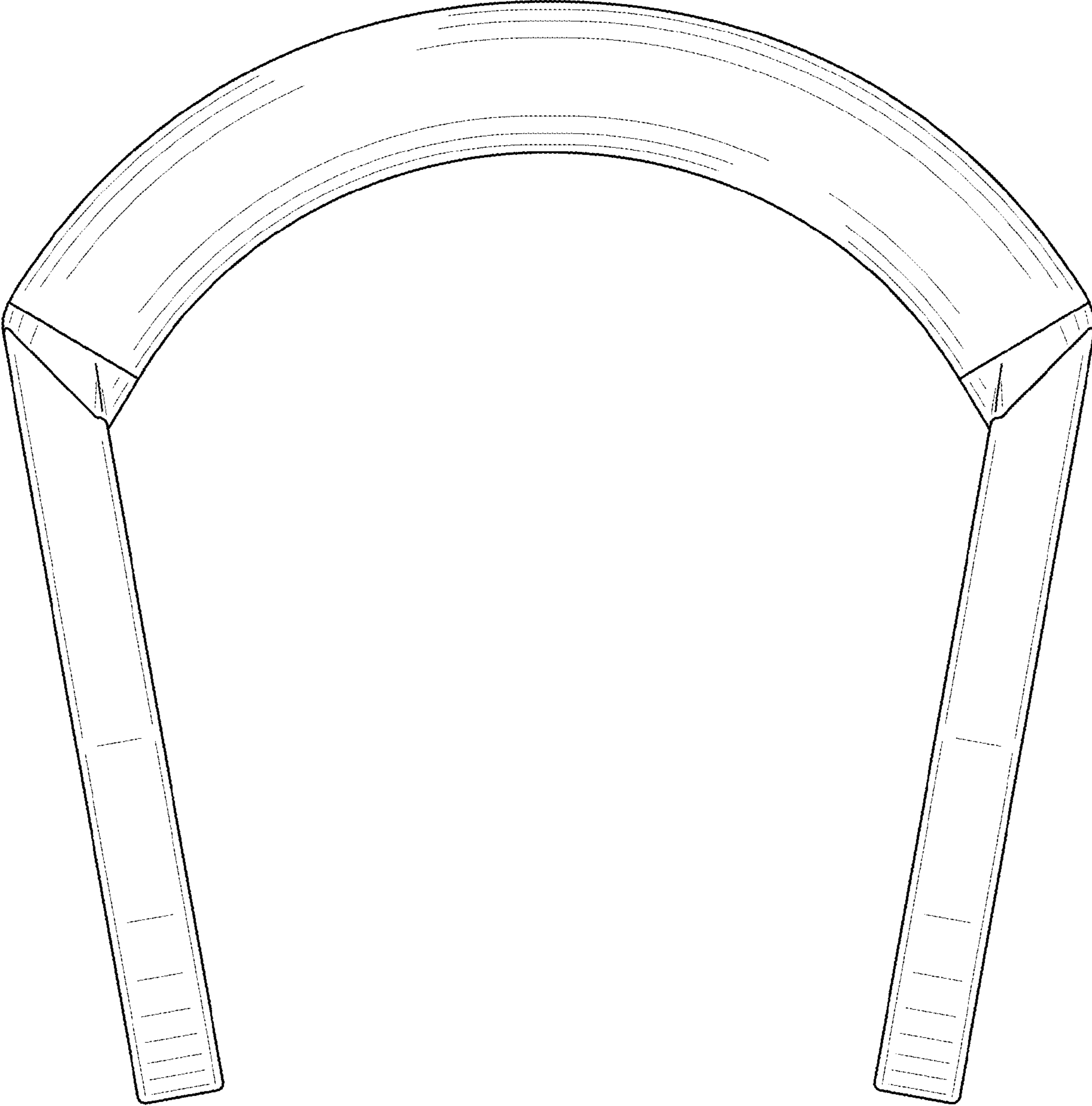

FIG. 3

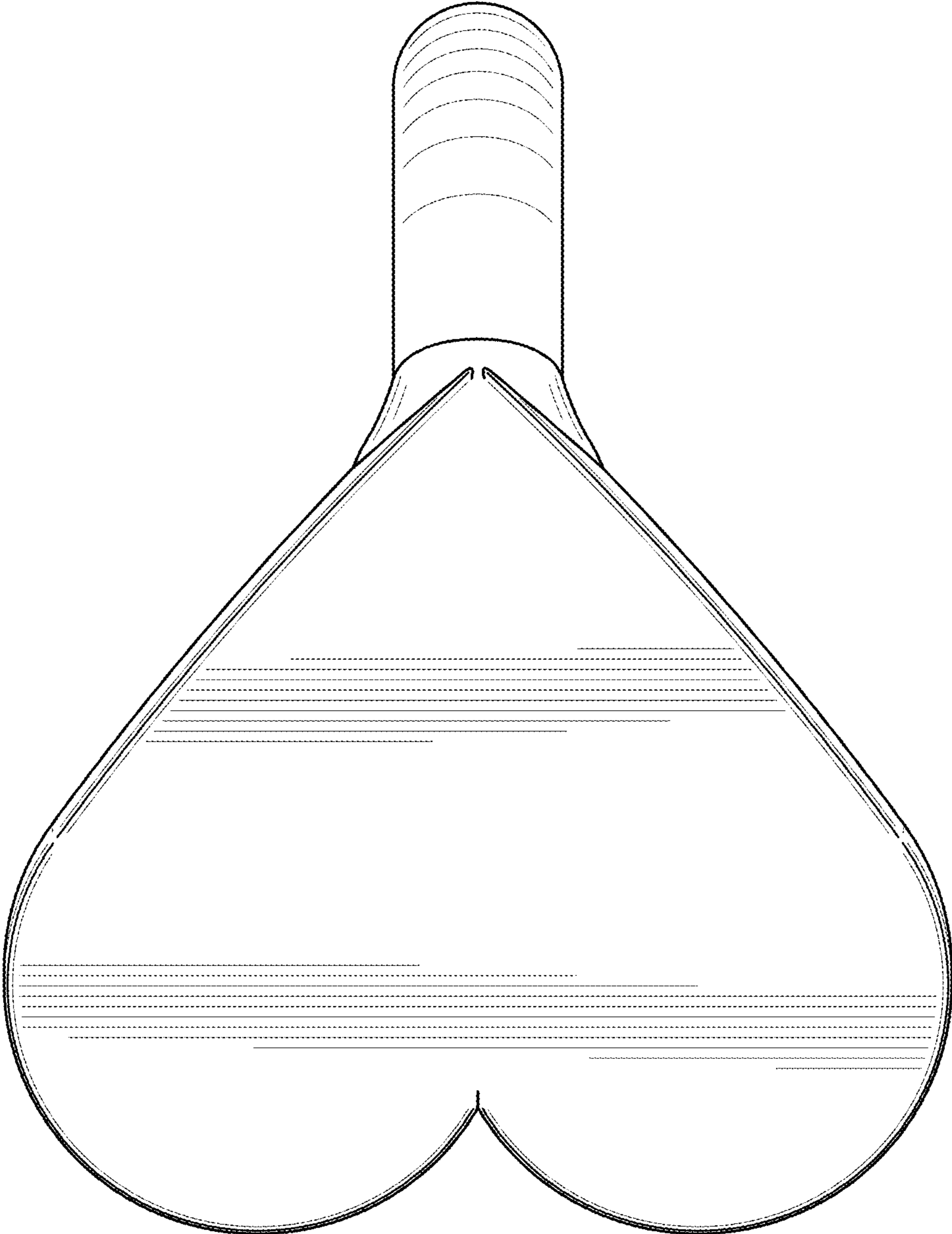

FIG. 4

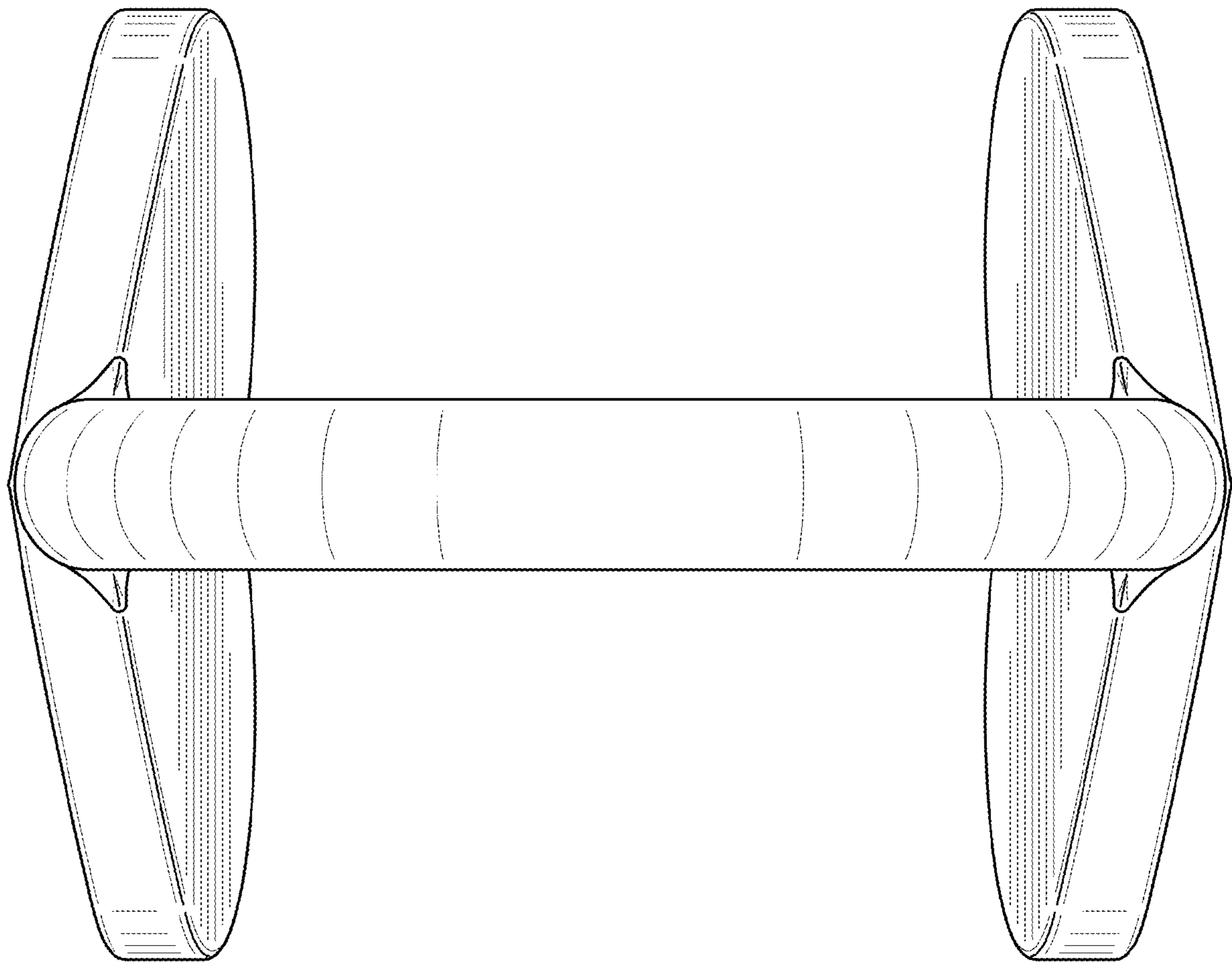

FIG. 5

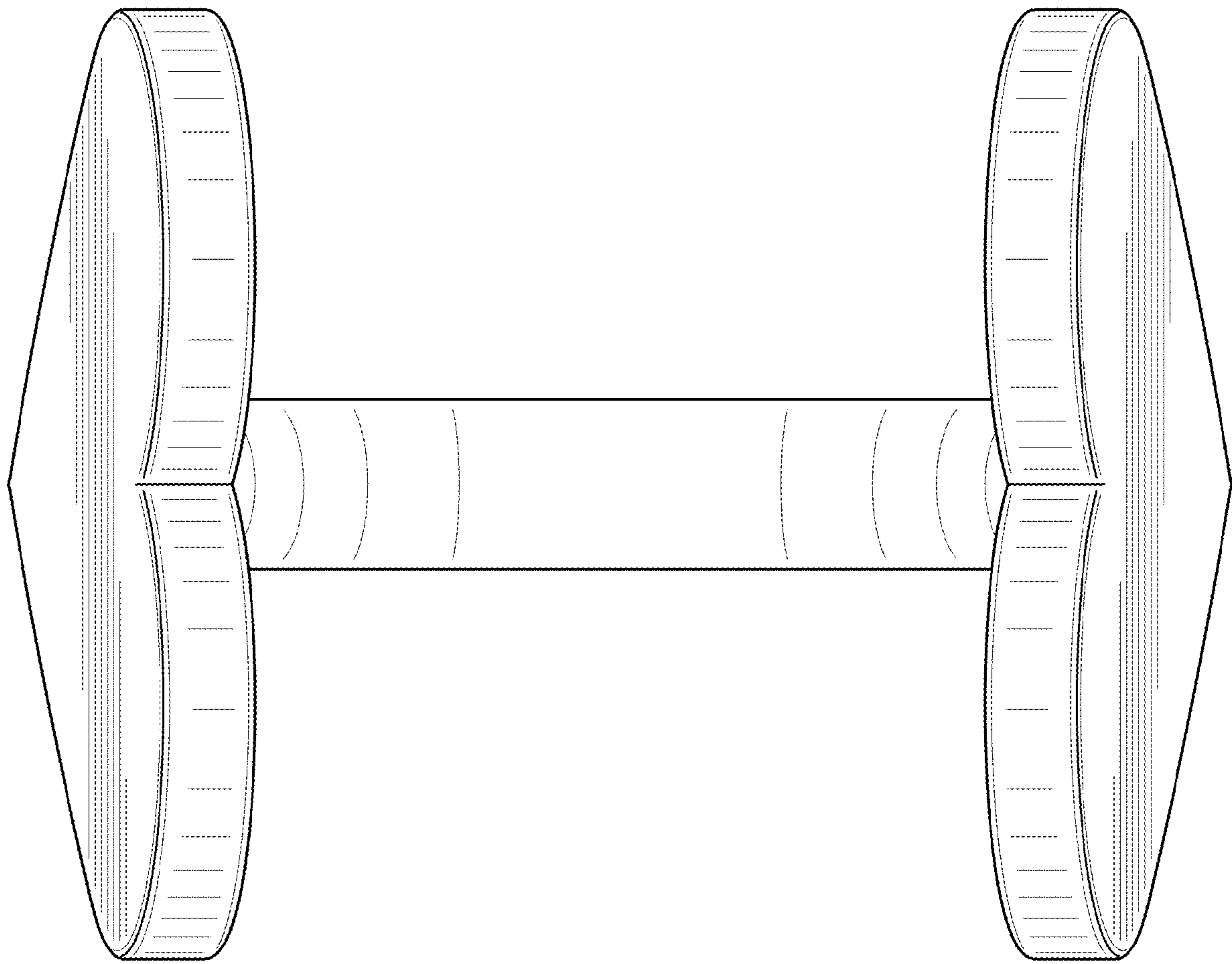

FIG. 6