



US00D940243S

(12) **United States Design Patent** (10) **Patent No.:** **US D940,243 S**
Yu (45) **Date of Patent:** **** Jan. 4, 2022**

(54) **STRAWBERRY SHAPED GAME BOARD**
(71) Applicant: **Xiaobing Yu**, Guangdong (CN)
(72) Inventor: **Xiaobing Yu**, Guangdong (CN)
(73) Assignee: **Dongguan Chokway Co., Ltd.**,
Dongguan (CN)
(**) Term: **15 Years**
(21) Appl. No.: **29/768,366**
(22) Filed: **Jan. 29, 2021**
(51) **LOC (13) Cl.** **21-01**
(52) **U.S. Cl.**
USPC **D21/313**
(58) **Field of Classification Search**
USPC D21/313, 366, 386, 389, 392, 397, 466,
D21/493, 496; D9/423, 499, 645, 721,
D9/756, 757, 761, 762
CPC A63F 3/00; A63F 3/00694; A63F 3/00176;
G07F 17/00
See application file for complete search history.

7,270,328 B1 * 9/2007 Parrales A63F 3/00176
273/260
D555,783 S * 11/2007 Chen D1/106
D585,735 S * 2/2009 Vovan D9/416
D604,114 S * 11/2009 Braidotti D7/628
D661,541 S * 6/2012 Braden D7/359
D692,066 S * 10/2013 Miller D21/392
D713,890 S * 9/2014 Elwell D21/341
D714,877 S * 10/2014 Kneitel D21/392
D715,867 S * 10/2014 Snijders D21/397
D717,879 S 11/2014 Shade
D779,321 S * 2/2017 Rubio D9/645
D782,334 S * 3/2017 Bishop D9/757
D818,835 S * 5/2018 Caly D9/645
D855,111 S * 7/2019 Cowan D21/344
D863,449 S * 10/2019 Shoptaugh D21/342
D873,660 S * 1/2020 Akana D9/436
D883,804 S * 5/2020 Petrosian D9/756
D886,446 S * 6/2020 Lee D3/218

(Continued)

Primary Examiner — Sandra Snapp
Assistant Examiner — Mehri Bajoul

(57) **CLAIM**

The ornamental design for a strawberry shaped game board,
as shown and described.

DESCRIPTION

FIG. 1 is a top, front, right side perspective view of a
strawberry shaped game board showing my new design;
FIG. 2 is a bottom, rear, left side perspective view thereof;
FIG. 3 is an enlarged front elevation view thereof;
FIG. 4 is an enlarged rear elevation view thereof;
FIG. 5 is an enlarged left side elevation view thereof;
FIG. 6 is an enlarged right side elevation view thereof;
FIG. 7 is a top plan view thereof; and,
FIG. 8 is a bottom plan view thereof.
The broken lines in the drawings illustrate portions of the
strawberry shaped game board that form no part of the
claimed design.

1 Claim, 6 Drawing Sheets

(56) **References Cited**
U.S. PATENT DOCUMENTS
D56,833 S * 12/1920 Plume D21/313
D86,586 S * 3/1932 Smith, Jr. D21/313
D158,112 S * 4/1950 Marks D21/313
D262,896 S * 2/1982 Dabbs D21/312
D265,408 S * 7/1982 Ericson D21/344
D275,020 S * 8/1984 Charves 273/284
D288,697 S * 3/1987 Newton D21/341
D346,552 S * 5/1994 Krupa D9/757
D371,961 S * 7/1996 Krupa D9/757
D372,051 S * 7/1996 Cullen D21/307
D389,870 S * 1/1998 Hart D19/86
D484,919 S * 1/2004 Campos D21/335
D489,971 S * 5/2004 Tamez D28/67

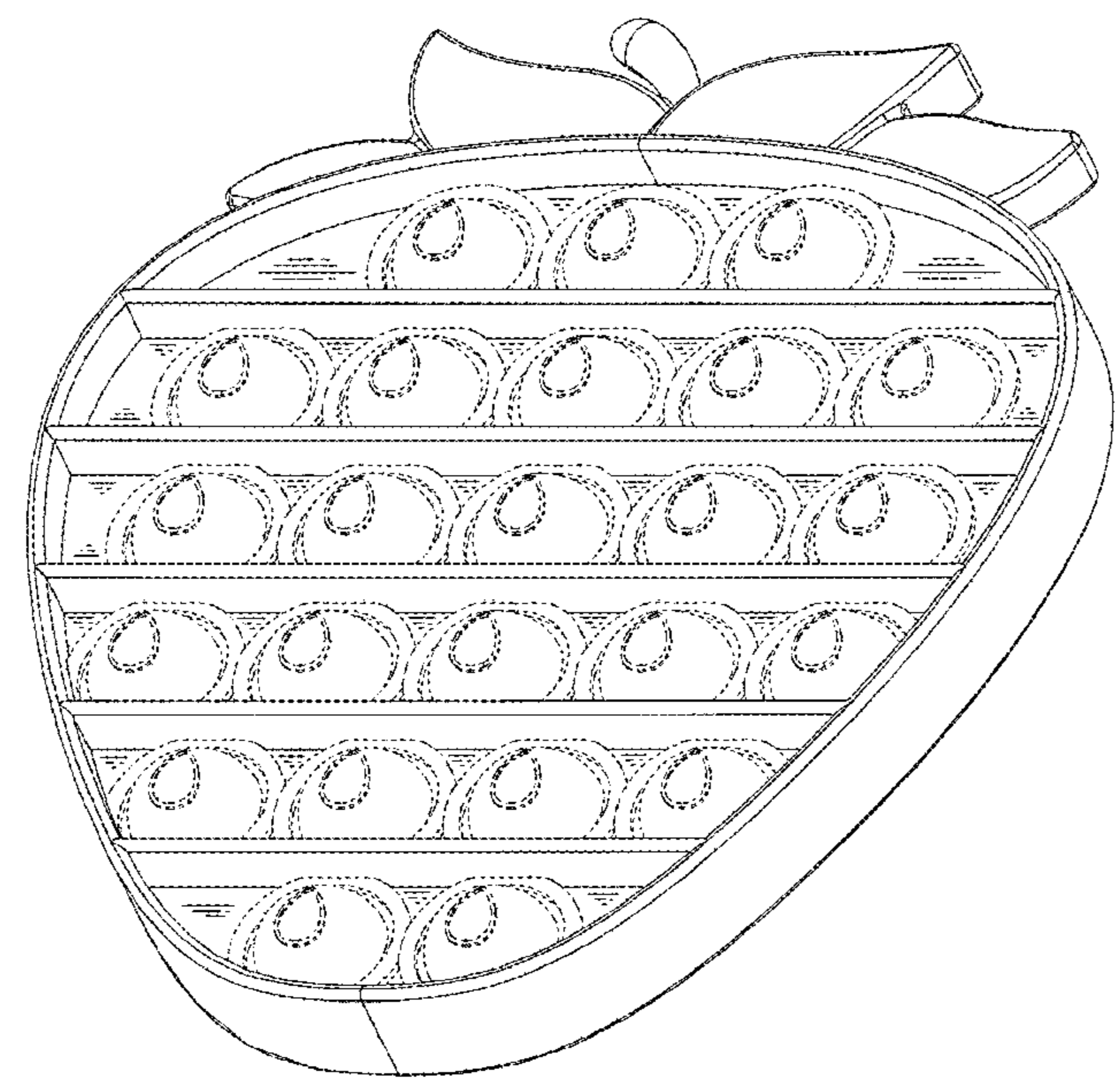

(56)

References Cited

U.S. PATENT DOCUMENTS

D890,847 S	7/2020	McClure	
D893,170 S *	8/2020	Lee	D3/218
D895,734 S	9/2020	Kallabat	
D914,067 S *	3/2021	Wu	D15/90
D915,475 S *	4/2021	Wu	D15/90
2006/0219594 A1 *	10/2006	Andrews	B65D 85/32 206/521.8

* cited by examiner

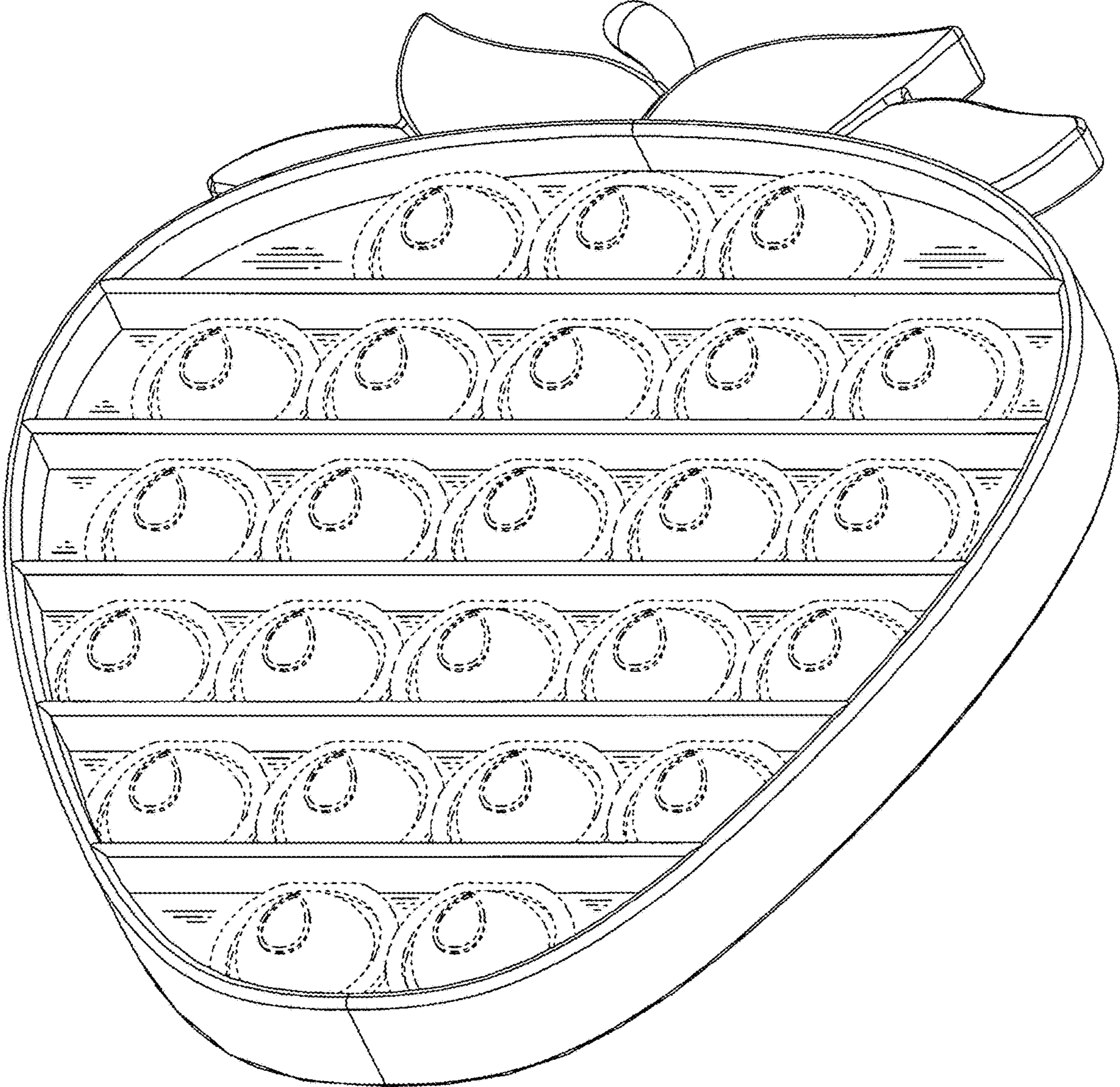

FIG.1

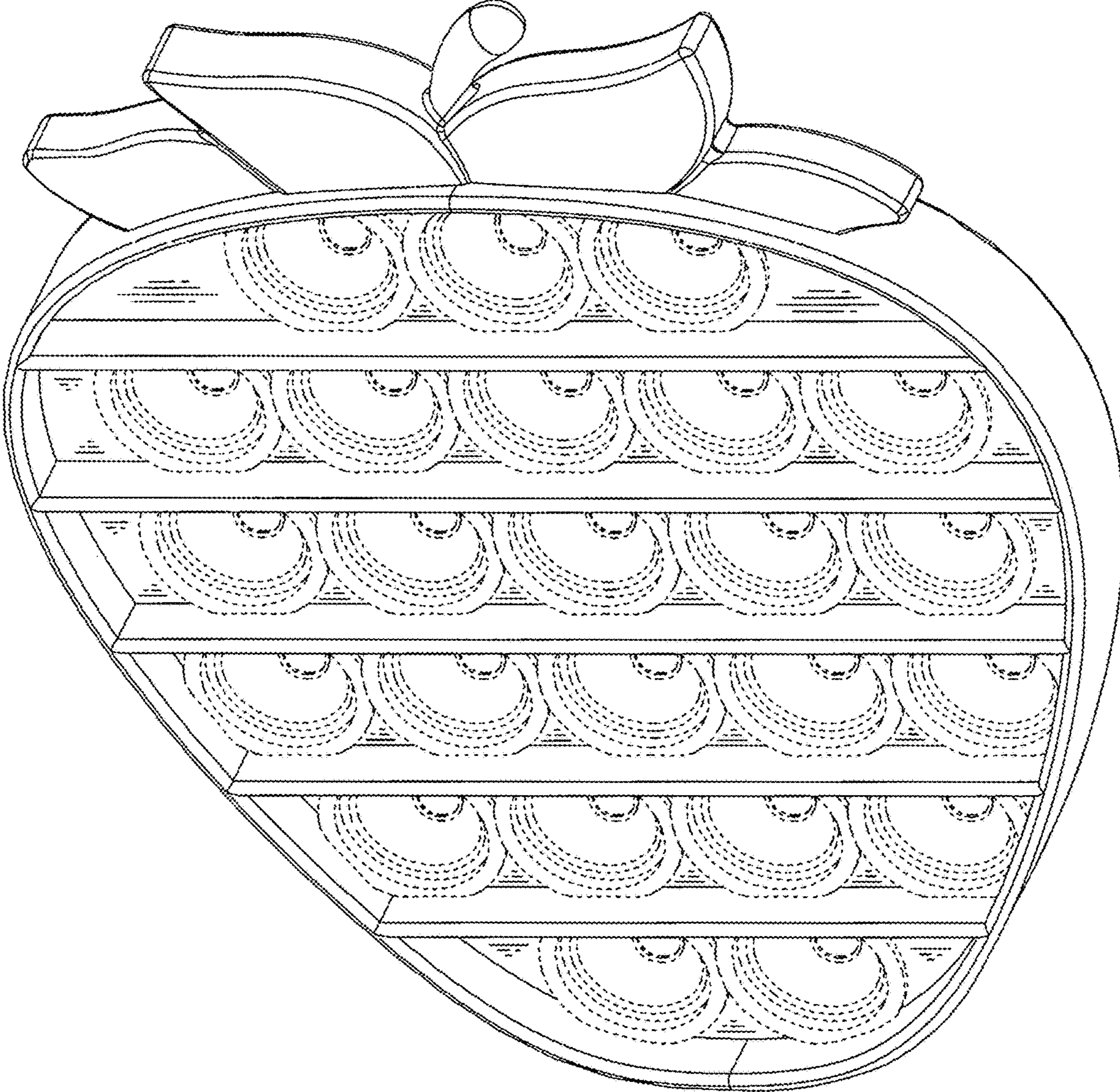

FIG.2

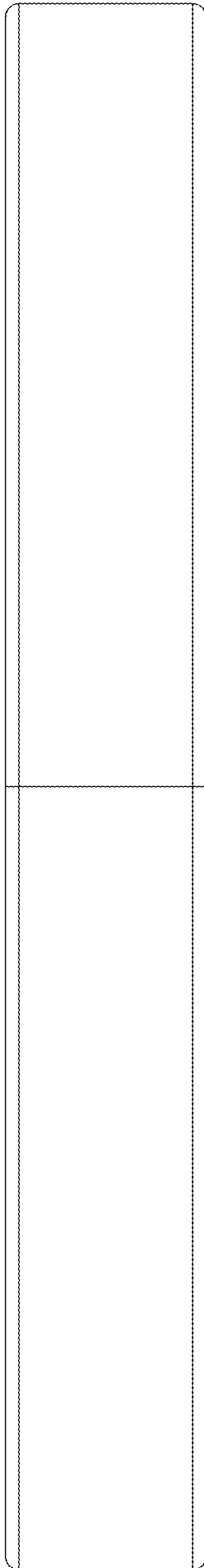

FIG. 3

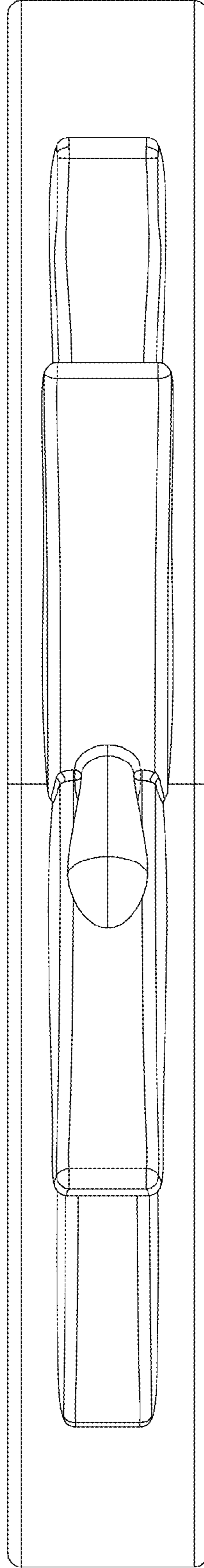

FIG. 4

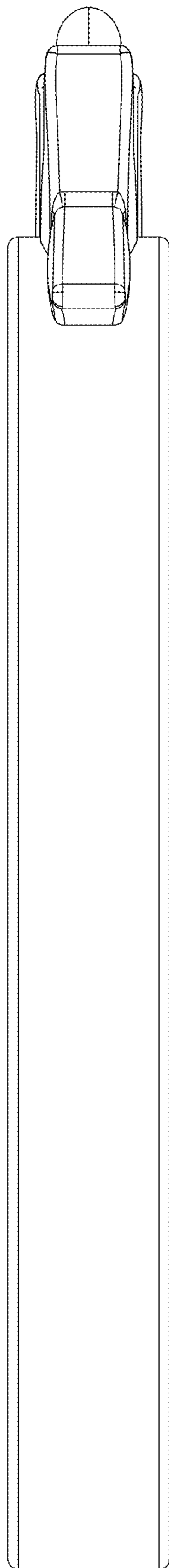

FIG.5

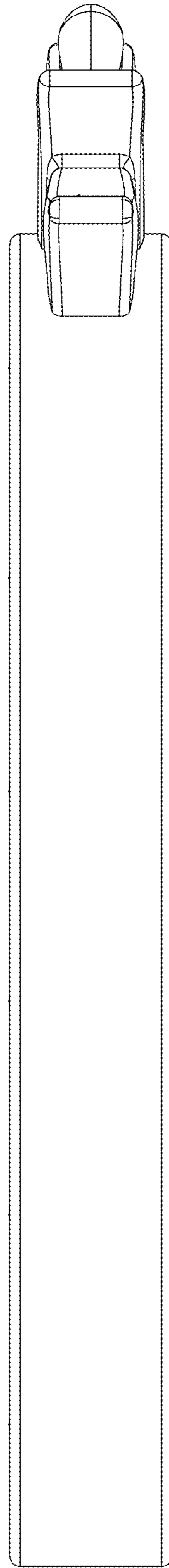

FIG.6

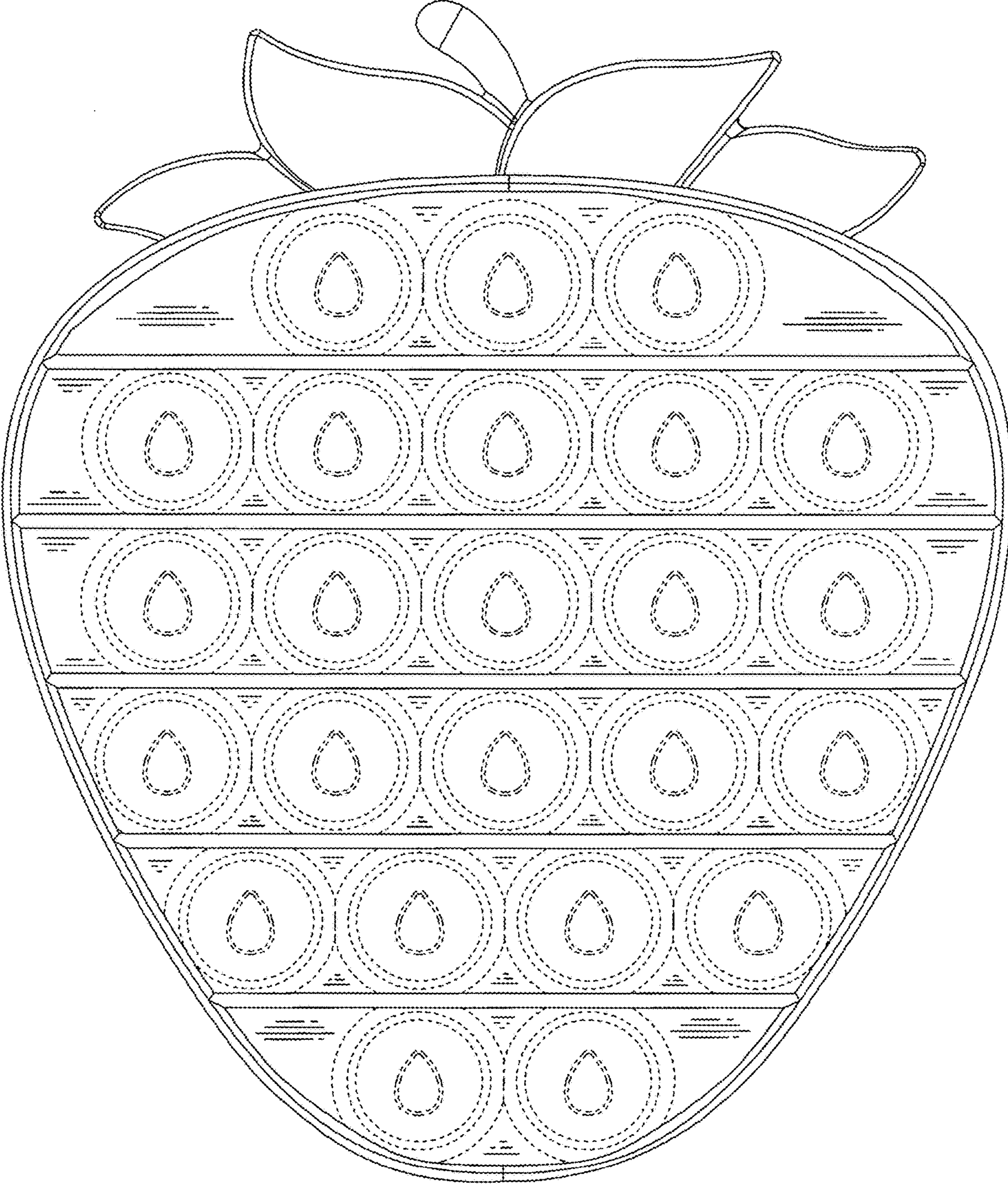

FIG.7

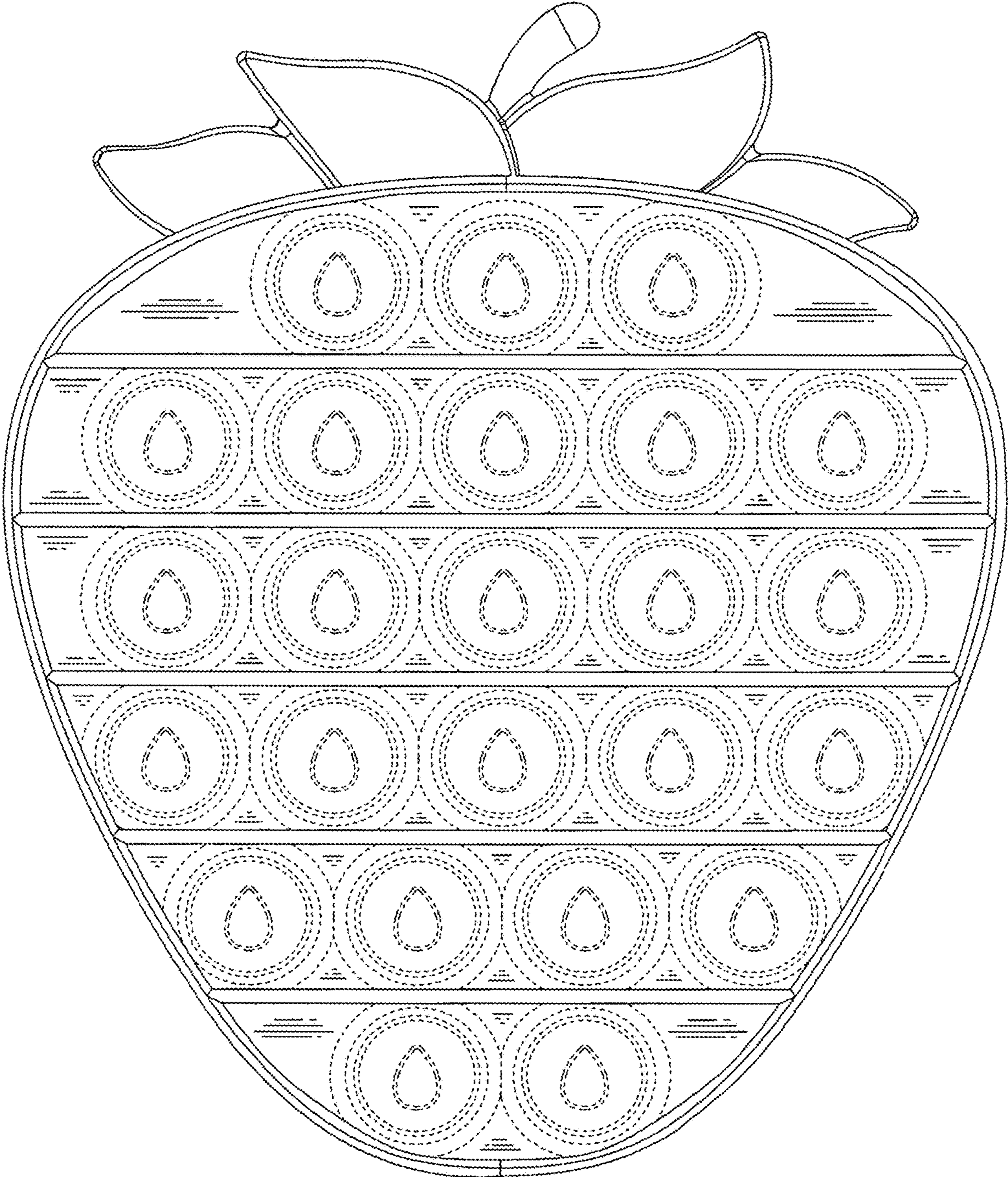

FIG.8