

US00D940230S

(12) **United States Design Patent**
Yang

(10) **Patent No.:** **US D940,230 S**
(45) **Date of Patent:** **** Jan. 4, 2022**

(54) **THUMB PIANO**

(71) Applicant: **Fei Yang**, Guangzhou (CN)

(72) Inventor: **Fei Yang**, Guangzhou (CN)

(**) Term: **15 Years**

(21) Appl. No.: **29/761,713**

(22) Filed: **Dec. 11, 2020**

(30) **Foreign Application Priority Data**

Aug. 4, 2020 (CN) 202030434791.5

(51) **LOC (13) Cl.** **17-01**

(52) **U.S. Cl.**
USPC **D17/7**

(58) **Field of Classification Search**
USPC D17/1, 2, 7, 99; D21/405, 409;
D14/203.1, 217
CPC ... G10C 1/00; G10C 1/02; G10C 1/04; G10C
3/00; G10C 3/12; G10C 5/00; G10C 5/10
See application file for complete search history.

(56) **References Cited**

U.S. PATENT DOCUMENTS

1,763,518	A *	6/1930	Haweis	G10D 13/08 84/408
3,610,085	A *	10/1971	Wilson et al.	G10D 13/08 84/402
D222,813	S *	1/1972	Wilson	D17/99
3,961,553	A *	6/1976	Schorr	G10D 13/08 84/408
D688,729	S *	8/2013	Trinca	D17/7
D920,424	S *	5/2021	Lin	D17/7
D923,081	S *	6/2021	Yang	D17/7

OTHER PUBLICATIONS

Music Store. https://www.musicstore.com/en_FI/EUR/Meinl-KL1705H-Wah-Wah-Kalimba-Acacia/art-DRU0040673-000. "Meinl

KL1705H Wah-Wah Kalimba Acacia". Date Unknown: Viewed Oct. 2021 (Year: 2021).*

Amazon. https://www.amazon.com/MIFOGE-Waterproof-Protective-Instrument-Beginners/dp/B085ZL6D1N/ref=sxin_13_pa_sp_search_thematic_sspa?cv_ct_cx=thumb%2Bpiano&dchild=1&keywords=thumb%2Bpiano&pd_rd_i=B085ZL6D1N&pd_rd_r=80974217-77bc-499e-9c71-c2e78d5002e3&pd_rd_w=usl16&pd_rd_wg=0pDRU&pf_rd_p=f21da57e-06e4-46a5-9148-e2dea2e78384&pf_rd_r=2RYBGJ9QCQXGRHXKZ6PM&qid=1635039775&sr=1-3-a73d1c8c-2fd2-4f19-aa41-2df022bcb241-spons&spLa=ZW5jcnlwdGVkUXVhbGlmaWVyPUFJWkJKQzgxRVBRS0ImZW5jcnlwdGVkSWQ9QTA0OTQ1MzRZWE9CT003R1IxNTkmZW5jcnlwdGVkQWRJZD1BMDk4NjkyODFOS0VYU01ENUVTUUsmd2lkZ2V0TmFtZT1zcF9zZWYy2hfdGh1bWF0aWMmYWN0aW9uPWNsaWNrUmVkaXJlY3QmZG9Ob3RMb2dDbGljaz10cnVI&th=1. "MIFOGE Kalimba Thumb Piano". Mar. 2020 (Year: 2020).*

* cited by examiner

Primary Examiner — R. Johnson

(57) **CLAIM**

The ornamental design for a thumb piano, as shown and described.

DESCRIPTION

FIG. 1 is a perspective view of a thumb piano showing my new design;
FIG. 2 is another perspective view thereof;
FIG. 3 is a front elevational view thereof;
FIG. 4 is a rear elevational view thereof;
FIG. 5 is a left side elevational view thereof;
FIG. 6 is a right side elevational view thereof;
FIG. 7 is a top plan view thereof; and,
FIG. 8 is a bottom plan view thereof.
The broken lines in the drawings depict portions of the thumb piano that form no part of the claimed design.

1 Claim, 8 Drawing Sheets

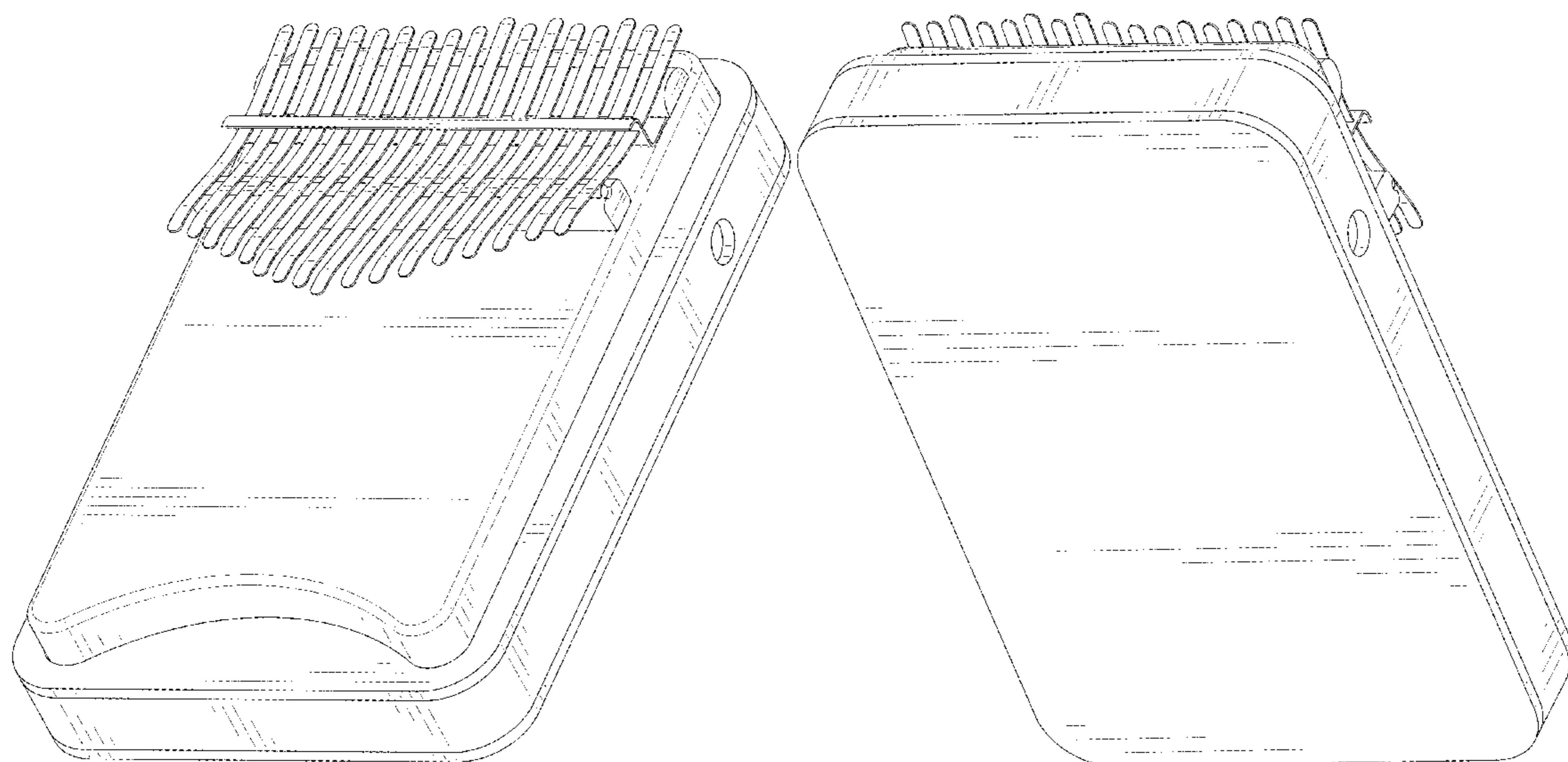

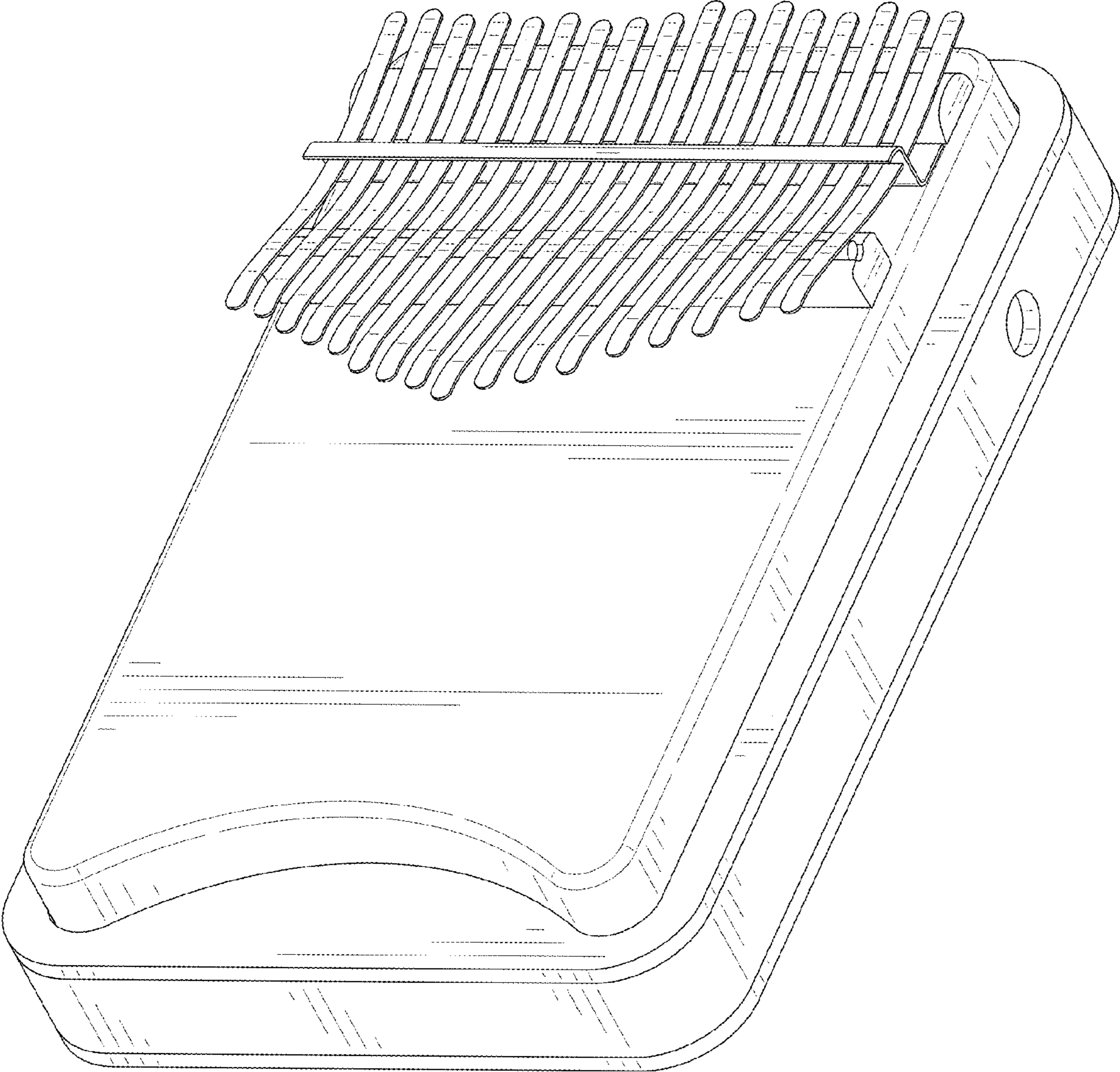

FIG. 1

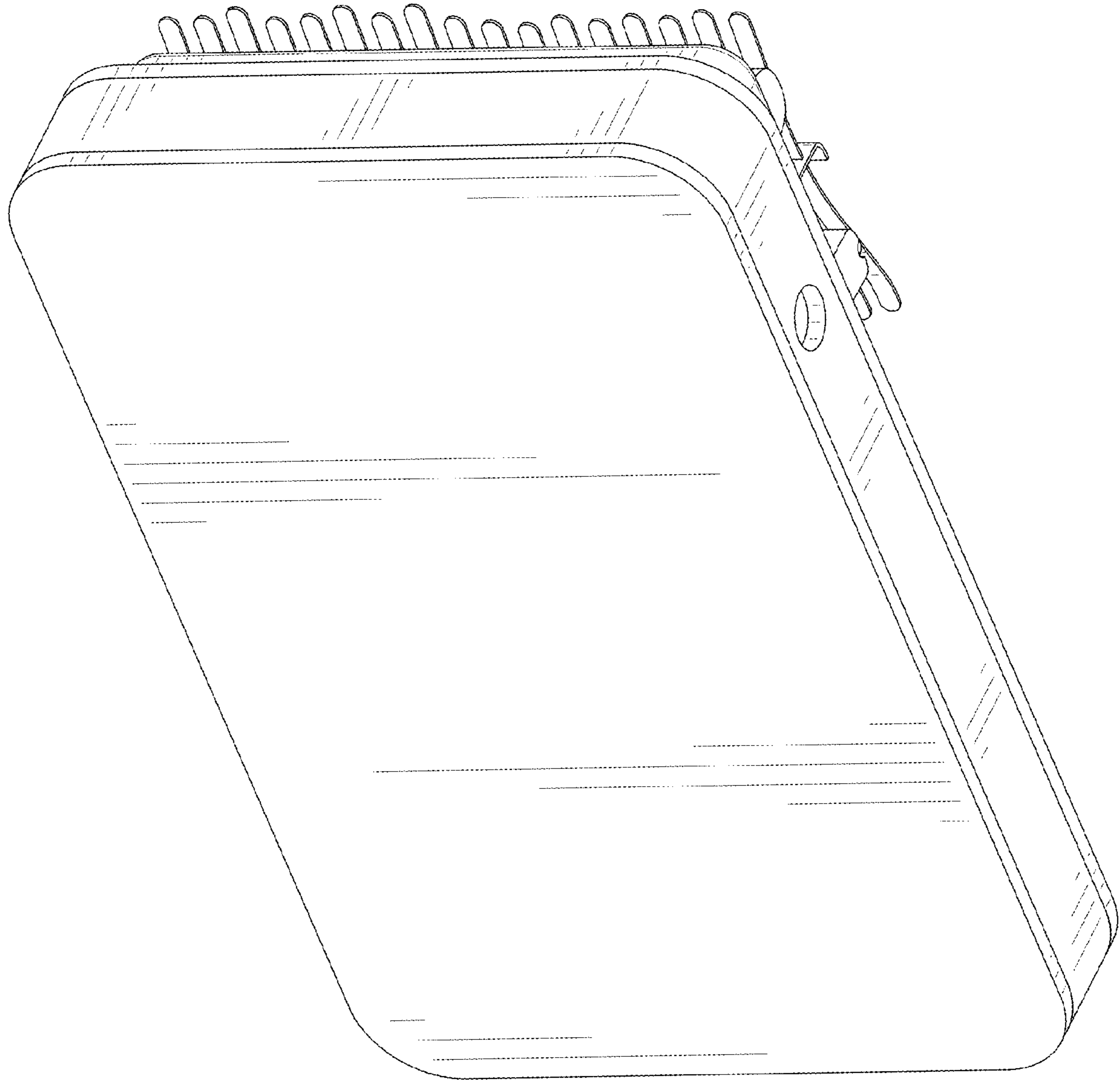

FIG. 2

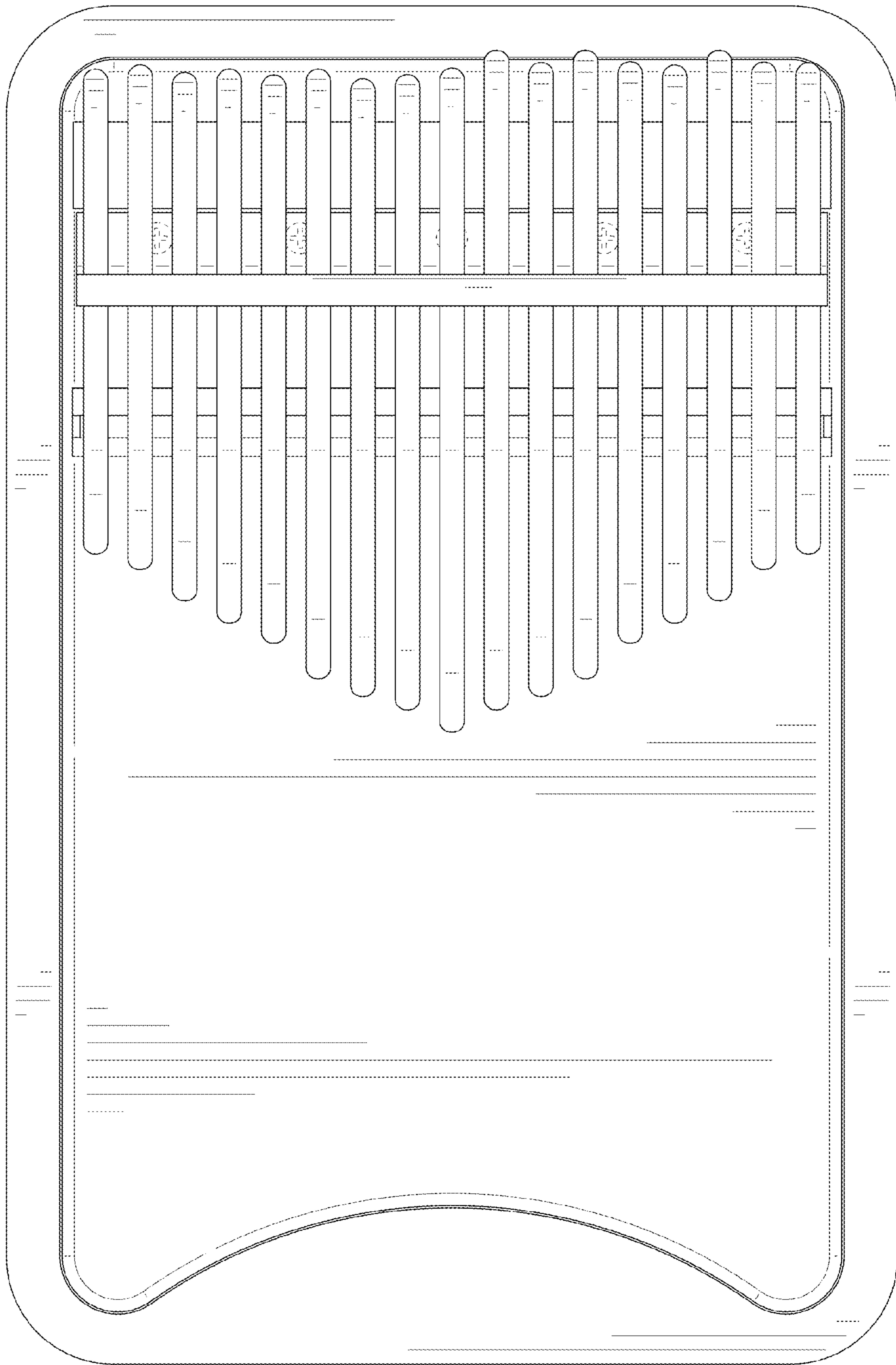

FIG. 3

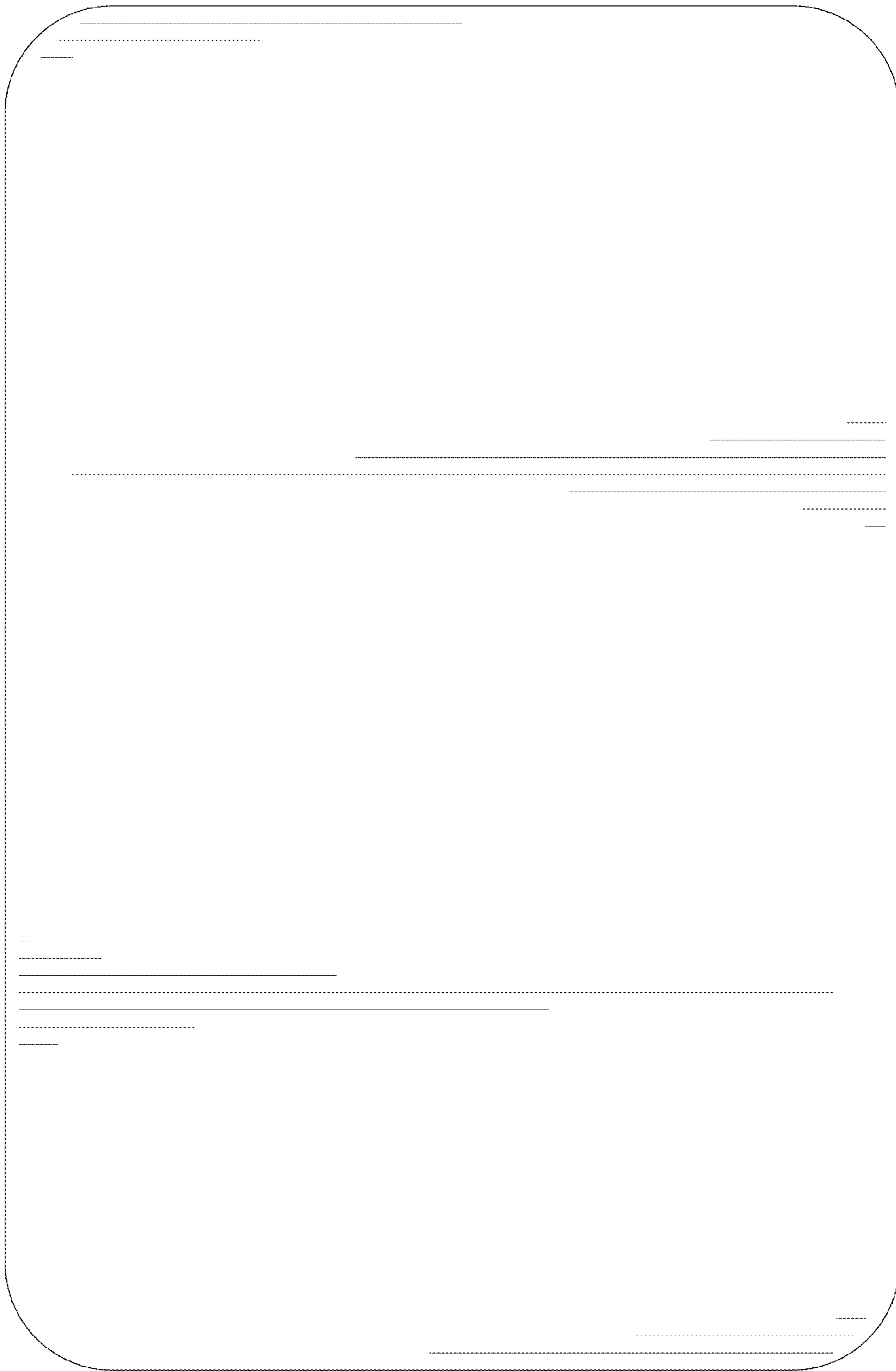

FIG. 4

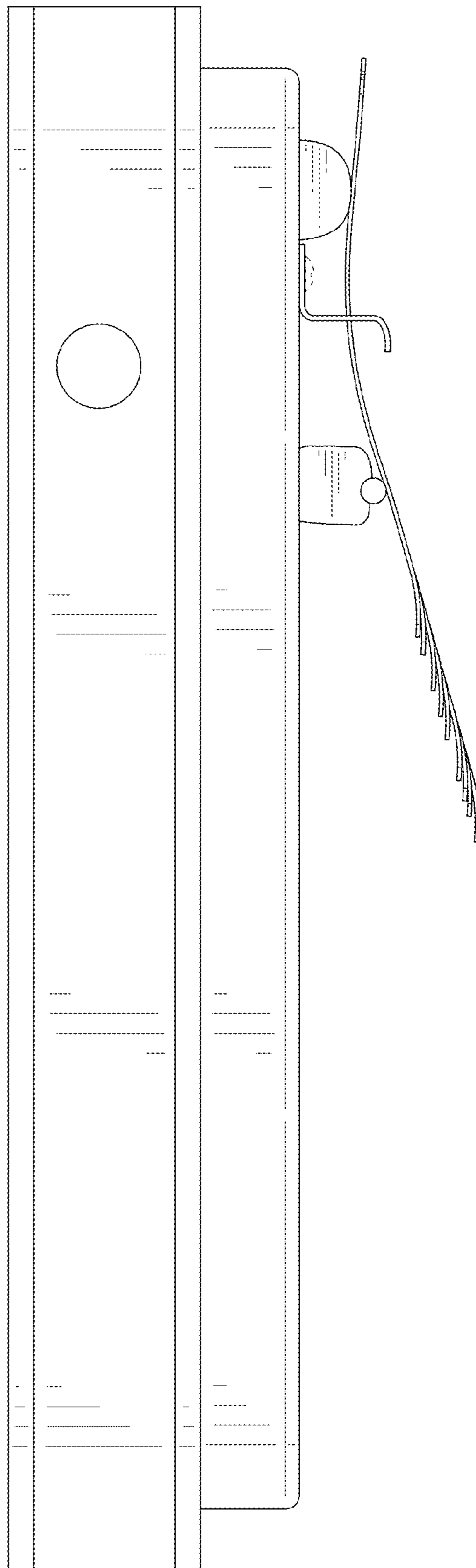

FIG. 5

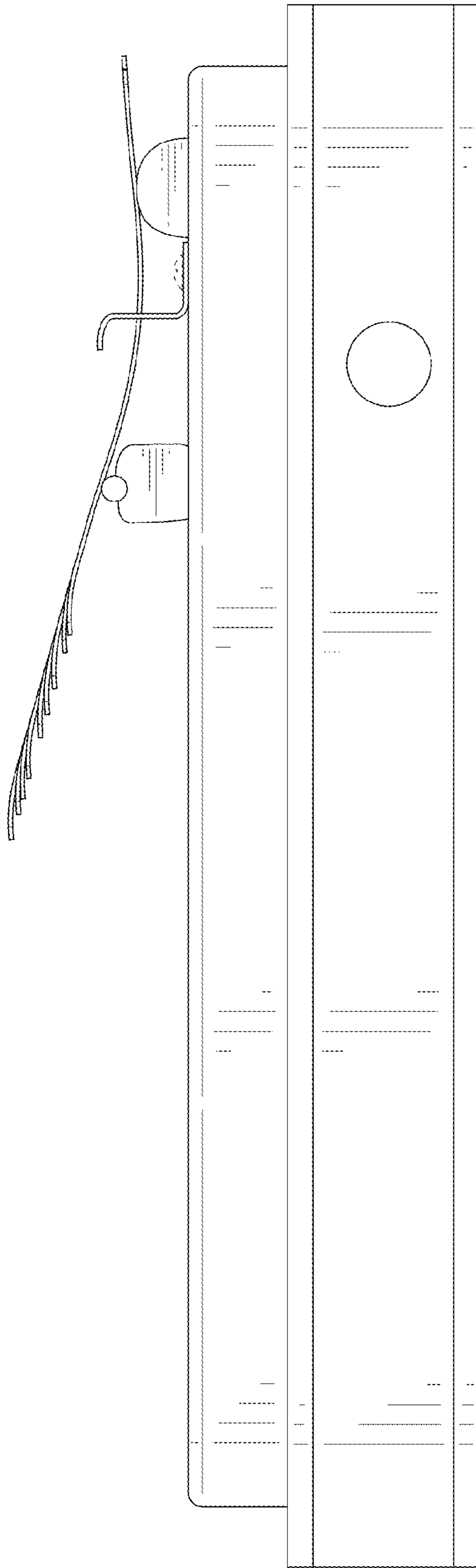

FIG. 6

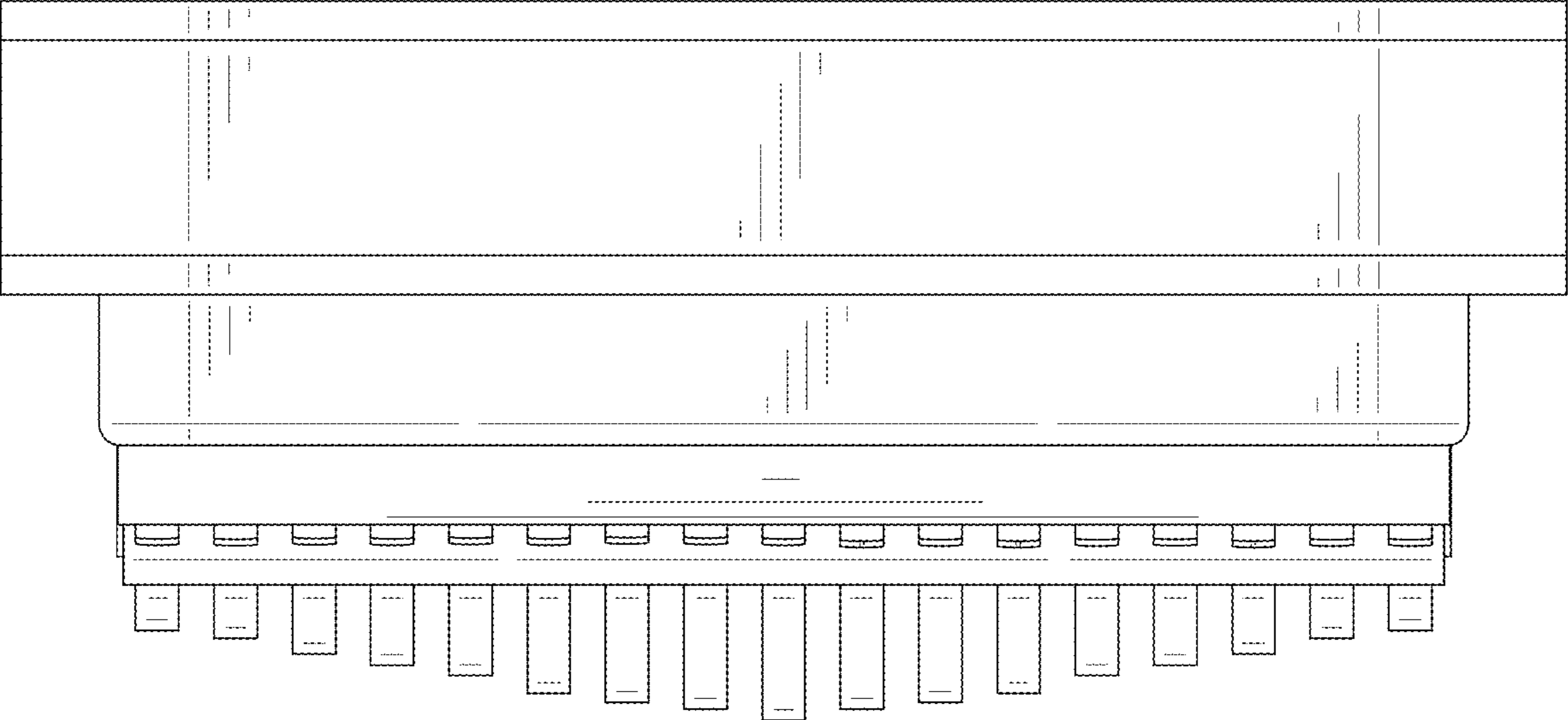

FIG. 7

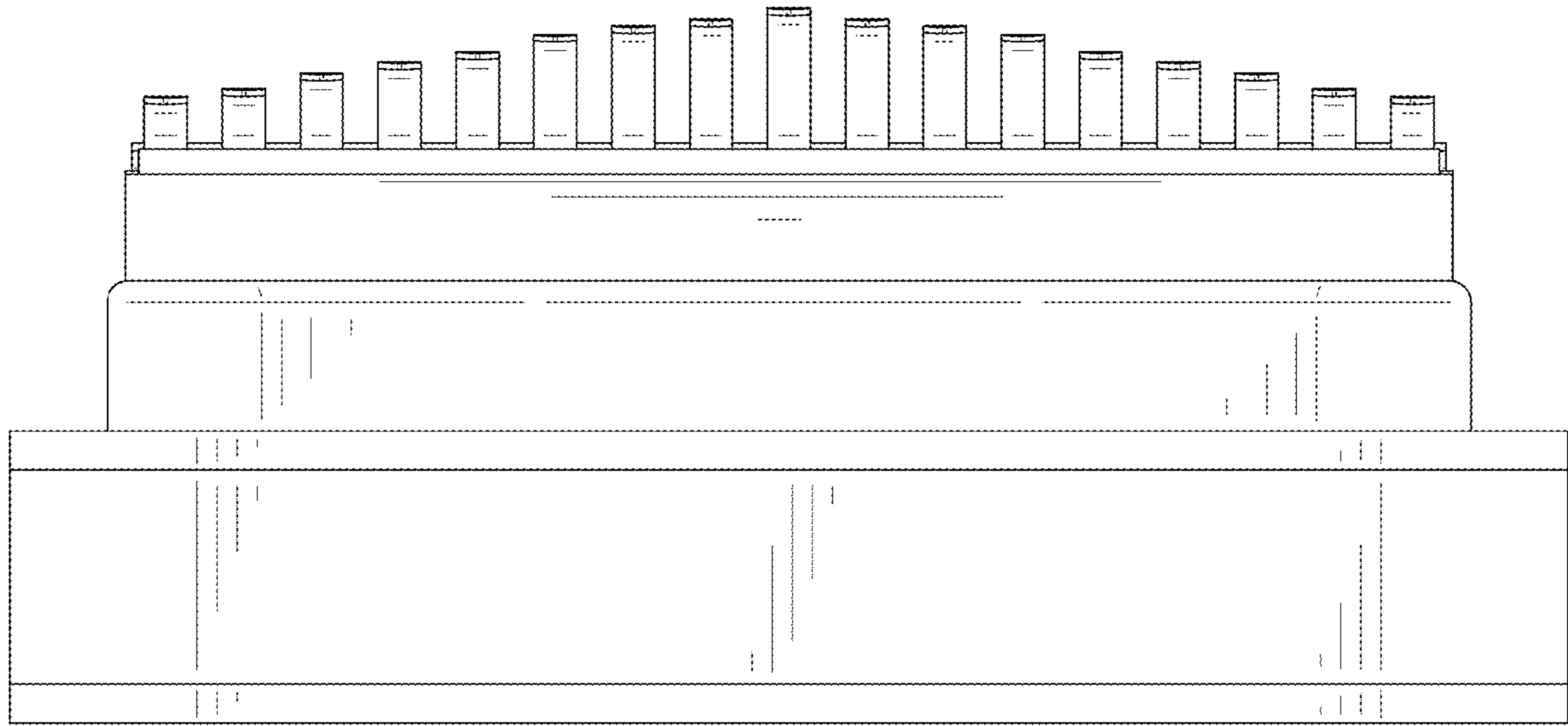

FIG. 8