

US00D940121S

(12) **United States Design Patent** (10) **Patent No.:** **US D940,121 S**
Lu (45) **Date of Patent:** **** Jan. 4, 2022**

(54) **MOBILE PHONE CASE**

(71) Applicant: **Ye Lu**, Hangzhou (CN)

(72) Inventor: **Ye Lu**, Hangzhou (CN)

(**) Term: **15 Years**

(21) Appl. No.: **29/660,502**

(22) Filed: **Aug. 21, 2018**

(30) **Foreign Application Priority Data**

Jun. 6, 2018 (CN) 201830281987.8

(51) **LOC (13) Cl.** **14-03**

(52) **U.S. Cl.**
USPC **D14/250**

(58) **Field of Classification Search**
USPC D14/203.3–203.7, 439, 251–253, 447,
D14/217, 240, 238.1, 250, 440, 248;
(Continued)

(56) **References Cited**

U.S. PATENT DOCUMENTS

D525,986 S * 8/2006 Kim D14/203.3
D580,424 S * 11/2008 Wang D14/248
(Continued)

Primary Examiner — Carla J Wright

(74) *Attorney, Agent, or Firm* — Wang Law Firm, Inc.

(57) **CLAIM**

The ornamental design for a mobile phone case, as shown and described.

DESCRIPTION

FIG. 1 is a front, right-side, and top perspective view of a mobile phone case showing a first embodiment of my new design with the camera cover in a closed position;
FIG. 2 is a front view thereof;
FIG. 3 is a rear view thereof;

FIG. 4 is a left view thereof;
FIG. 5 is a right view thereof;
FIG. 6 is a top view thereof;
FIG. 7 is a bottom view thereof;
FIG. 8 is a front, right-side, and top perspective view thereof showing an environmental mobile phone within the case;
FIG. 9 is a front, right-side, and top perspective view of the mobile phone case with the camera cover in an open position;
FIG. 10 is a front view thereof;
FIG. 11 is a rear view thereof;
FIG. 12 is a left view thereof;
FIG. 13 is a right view thereof;
FIG. 14 is a top view thereof;
FIG. 15 is a bottom view thereof;
FIG. 16 is a front, right-side, and top perspective view thereof showing an environmental mobile phone within the case;
FIG. 17 is a front, right-side, and top perspective view of a mobile phone case showing a second embodiment of my new design with the camera cover in a closed position;
FIG. 18 is a front view thereof;
FIG. 19 is a rear view thereof;
FIG. 20 is a left view thereof;
FIG. 21 is a right view thereof;
FIG. 22 is a top view thereof;
FIG. 23 is a bottom view thereof;
FIG. 24 is a front, right-side, and top perspective view thereof showing an environmental mobile phone within the case;
FIG. 25 is a front, right-side, and top perspective view of the mobile phone case with the camera cover in an open position;
FIG. 26 is a front view thereof;
FIG. 27 is a rear view thereof;
FIG. 28 is a left view thereof;
FIG. 29 is a right view thereof;
FIG. 30 is a top view thereof;
FIG. 31 is a bottom view thereof;
FIG. 32 is a front, right-side, and top perspective view thereof showing an environmental mobile phone within the case;

(Continued)

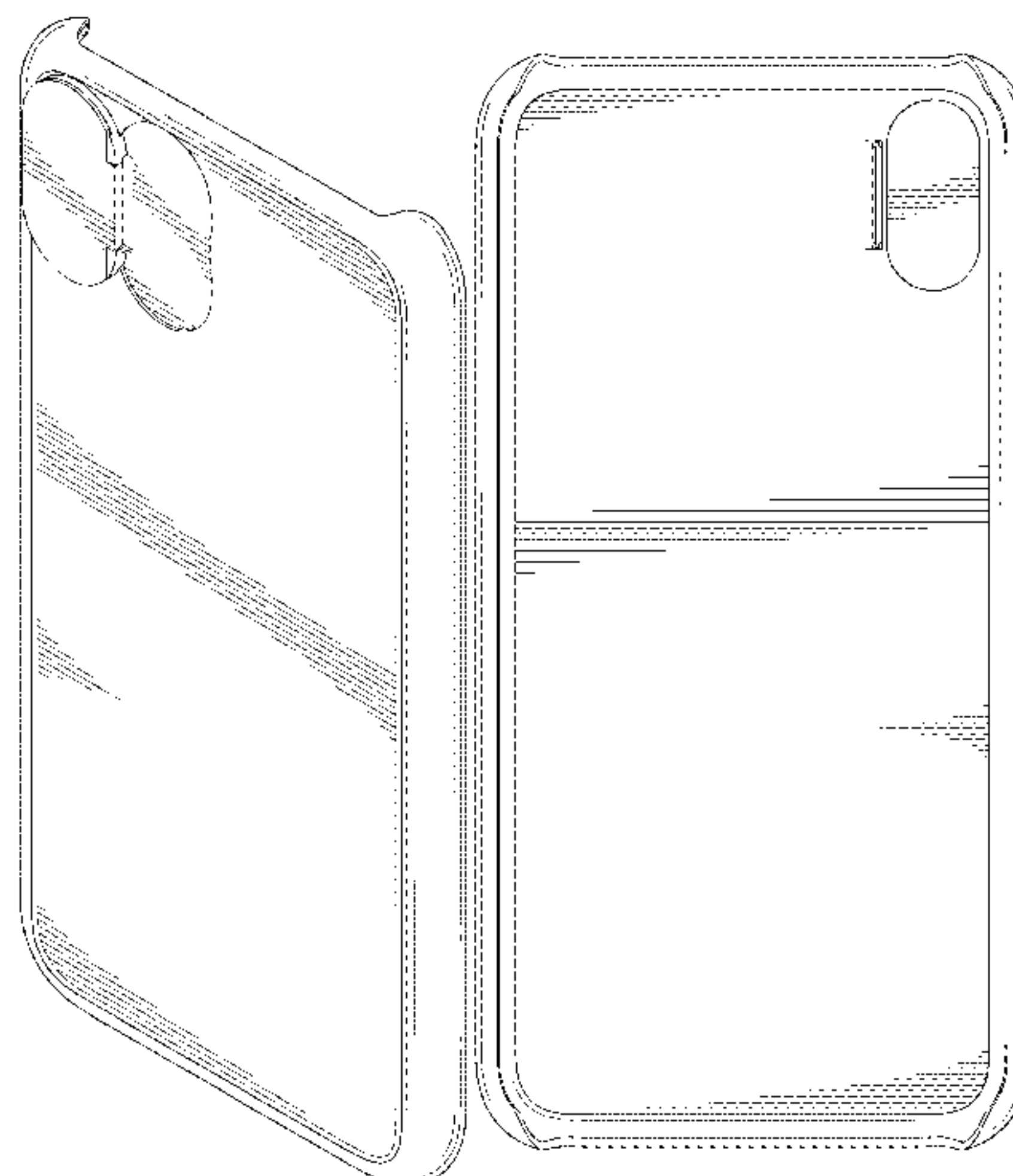

FIG. 33 is a front, right-side, and top perspective view of a mobile phone case showing a third embodiment of my new design with the camera cover in a closed position;

FIG. 34 is a front view thereof;

FIG. 35 is a rear view thereof;

FIG. 36 is a left view thereof;

FIG. 37 is a right view thereof;

FIG. 38 is a top view thereof;

FIG. 39 is a bottom view thereof;

FIG. 40 is a front, right-side, and top perspective view thereof showing an environmental mobile phone within the case;

FIG. 41 is a front, right-side, and top perspective view of the mobile phone case with the camera cover in an open position;

FIG. 42 is a front view thereof;

FIG. 43 is a rear view thereof;

FIG. 44 is a left view thereof;

FIG. 45 is a right view thereof;

FIG. 46 is a top view thereof;

FIG. 47 is a bottom view thereof;

FIG. 48 is a front, right-side, and top perspective view thereof showing an environmental mobile phone within the case;

FIG. 49 is a front, right-side, and top perspective view of a mobile phone case showing a fourth embodiment of my new design with the camera cover in a closed position;

FIG. 50 is a front view thereof;

FIG. 51 is a rear view thereof;

FIG. 52 is a left view thereof;

FIG. 53 is a right view thereof;

FIG. 54 is a top view thereof;

FIG. 55 is a bottom view thereof;

FIG. 56 is a front, right-side, and top perspective view thereof showing an environmental mobile phone within the case;

FIG. 57 is a front, right-side, and top perspective view of the mobile phone case with the camera cover in an open position;

FIG. 58 is a front view thereof;

FIG. 59 is a rear view thereof;

FIG. 60 is a left view thereof;

FIG. 61 is a right view thereof;

FIG. 62 is a top view thereof;

FIG. 63 is a bottom view thereof;

FIG. 64 is a front, right-side, and top perspective view thereof showing an environmental mobile phone within the case;

FIG. 65 is a front, right-side, and top perspective view of a mobile phone case showing a fifth embodiment of my new design with the camera cover in a closed position;

FIG. 66 is a front view thereof;

FIG. 67 is a rear view thereof;

FIG. 68 is a left view thereof;

FIG. 69 is a right view thereof;

FIG. 70 is a top view thereof;

FIG. 71 is a bottom view thereof;

FIG. 72 is a front, right-side, and top perspective view thereof showing an environmental mobile phone within the case;

FIG. 73 is a front, right-side, and top perspective view of the mobile phone case with the camera cover in an open position;

FIG. 74 is a front view thereof;

FIG. 75 is a rear view thereof;

FIG. 76 is a left view thereof;

FIG. 77 is a right view thereof;

FIG. 78 is a top view thereof;

FIG. 79 is a bottom view thereof;

FIG. 80 is a front, right-side, and top perspective view thereof showing an environmental mobile phone within the case;

FIG. 81 is a front, right-side, and top perspective view of a mobile phone case showing a sixth embodiment of my new design with the camera cover in a closed position;

FIG. 82 is a front view thereof;

FIG. 83 is a rear view thereof;

FIG. 84 is a left view thereof;

FIG. 85 is a right view thereof;

FIG. 86 is a top view thereof;

FIG. 87 is a bottom view thereof;

FIG. 88 is a front, right-side, and top perspective view thereof showing an environmental mobile phone within the case;

FIG. 89 is a front, right-side, and top perspective view of the mobile phone case with the camera cover in an open position;

FIG. 90 is a front view thereof;

FIG. 91 is a rear view thereof;

FIG. 92 is a left view thereof;

FIG. 93 is a right view thereof;

FIG. 94 is a top view thereof;

FIG. 95 is a bottom view thereof;

FIG. 96 is a front, right-side, and top perspective view thereof showing an environmental mobile phone within the case;

FIG. 97 is a front, right-side, and top perspective view of a mobile phone case showing a seventh embodiment of my new design with the camera cover in a closed position;

FIG. 98 is a front view thereof;

FIG. 99 is a rear view thereof;

FIG. 100 is a left view thereof;

FIG. 101 is a right view thereof;

FIG. 102 is a top view thereof;

FIG. 103 is a bottom view thereof;

FIG. 104 is a front, right-side, and top perspective view thereof showing an environmental mobile phone within the case;

FIG. 105 is a front, right-side, and top perspective view of the mobile phone case with the camera cover in an open position;

FIG. 106 is a front view thereof;

FIG. 107 is a rear view thereof;

FIG. 108 is a left view thereof;

FIG. 109 is a right view thereof;

FIG. 110 is a top view thereof;

FIG. 111 is a bottom view thereof;

FIG. 112 is a front, right-side, and top perspective view thereof showing an environmental mobile phone within the case;

FIG. 113 is a front, right-side, and top perspective view of a mobile phone case showing an eighth embodiment of my new design with the camera cover in a closed position;

FIG. 114 is a front view thereof;

FIG. 115 is a rear view thereof;

FIG. 116 is a left view thereof;

FIG. 117 is a right view thereof;

FIG. 118 is a top view thereof;

FIG. 119 is a bottom view thereof;

FIG. 120 is a front, right-side, and top perspective view thereof showing an environmental mobile phone within the case;

FIG. 121 is a front, right-side, and top perspective view of the mobile phone case with the camera cover in an open position;

FIG. 122 is a front view thereof;

FIG. 123 is a rear view thereof;

FIG. 124 is a left view thereof;

FIG. 125 is a right view thereof;

FIG. 126 is a top view thereof;

FIG. 127 is a bottom view thereof;

FIG. 128 is a front, right-side, and top perspective view thereof showing an environmental mobile phone within the case;

FIG. 129 is a front, right-side, and top perspective view of a mobile phone case showing a ninth embodiment of my new design with the camera cover in a closed position;

FIG. 130 is a front view thereof;

FIG. 131 is a rear view thereof;

FIG. 132 is a left view thereof;

FIG. 133 is a right view thereof;

FIG. 134 is a top view thereof;

FIG. 135 is a bottom view thereof;

FIG. 136 is a front, right-side, and top perspective view thereof showing an environmental mobile phone within the case;

FIG. 137 is a front, right-side, and top perspective view of the mobile phone case with the camera cover in an open position;

FIG. 138 is a front view thereof;

FIG. 139 is a rear view thereof;

FIG. 140 is a left view thereof;

FIG. 141 is a right view thereof;

FIG. 142 is a top view thereof;

FIG. 143 is a bottom view thereof;

FIG. 144 is a front, right-side, and top perspective view thereof showing an environmental mobile phone within the case;

FIG. 145 is a front, right-side, and top perspective view of a mobile phone case showing a tenth embodiment of my new design with the camera cover in a closed position;

FIG. 146 is a front view thereof;

FIG. 147 is a rear view thereof;

FIG. 148 is a left view thereof;

FIG. 149 is a right view thereof;

FIG. 150 is a top view thereof;

FIG. 151 is a bottom view thereof;

FIG. 152 is a front, right-side, and top perspective view thereof showing an environmental mobile phone within the case;

FIG. 153 is a front, right-side, and top perspective view of the mobile phone case with the camera cover in an open position;

FIG. 154 is a front view thereof;

FIG. 155 is a rear view thereof;

FIG. 156 is a left view thereof;

FIG. 157 is a right view thereof;

FIG. 158 is a top view thereof;

FIG. 159 is a bottom view thereof; and,

FIG. 160 is a front, right-side, and top perspective view thereof showing an environmental mobile phone within the case.

The broken lines in FIGS. 8, 16, 24, 32, 40, 48, 56, 64, 72, 80, 88, 96, 104, 112, 120, 128, 136, 144, 152, and 160 depict an environmental mobile phone that forms no part of the claimed design.

1 Claim, 160 Drawing Sheets

(58) **Field of Classification Search**
 USPC D13/107–108, 103, 119; D3/201, 218, D3/247, 249, 269, 273, 301, 303
 CPC . H04B 1/3888; A45C 13/02; A45C 2011/002; A45C 1/06; A45C 11/00; A45F 2005/026; A45F 2200/0525; A45F 2200/0516; H04M 1/0283; H04M 1/0202
 See application file for complete search history.

(56) **References Cited**

U.S. PATENT DOCUMENTS

| | | | | | |
|--------------|------|---------|--------------------|-------|-------------------------|
| D603,389 | S * | 11/2009 | Khan | | D14/250 |
| D625,303 | S * | 10/2010 | Kim | | D14/250 |
| D643,029 | S * | 8/2011 | Feng | | D14/250 |
| D669,112 | S * | 10/2012 | Gustaveson | | G03B 11/041 D16/237 |
| D675,197 | S * | 1/2013 | Losiewicz | | D14/250 |
| D686,607 | S * | 7/2013 | Hong | | D14/250 |
| D711,861 | S * | 8/2014 | Mei | | D14/250 |
| D721,072 | S * | 1/2015 | Laffon de Mazieres | | D14/250 |
| D735,182 | S * | 7/2015 | Watkins | | D14/250 |
| D737,263 | S * | 8/2015 | Armstrong | | D14/250 |
| D748,634 | S * | 2/2016 | Hofer | | D14/440 |
| D749,555 | S * | 2/2016 | Poon | | D14/250 |
| D759,644 | S * | 6/2016 | Penn | | D14/250 |
| D759,645 | S * | 6/2016 | Penn | | D14/250 |
| D764,474 | S * | 8/2016 | Penn | | D14/440 |
| D764,475 | S * | 8/2016 | Penn | | D14/440 |
| D772,855 | S * | 11/2016 | Ju | | D14/250 |
| D777,160 | S * | 1/2017 | Kim | | D14/250 |
| D807,870 | S * | 1/2018 | Lee | | D14/250 |
| D813,220 | S * | 3/2018 | Wright | | D14/250 |
| D816,149 | S * | 4/2018 | Dalton | | D16/237 |
| 10,015,296 | B1 * | 7/2018 | Haymond | | H04M 1/0252 |
| D886,181 | S * | 6/2020 | Lu | | D16/237 |
| D898,807 | S * | 10/2020 | Roberts | | D16/237 |
| D926,182 | S * | 7/2021 | Miller | | D14/250 |
| 2012/0112031 | A1 * | 5/2012 | Gormick | | G06F 1/1686 248/371 |
| 2014/0227026 | A1 * | 8/2014 | O'Neill | | G03B 17/08 403/322.4 |
| 2015/0320167 | A1 * | 11/2015 | Nguyen | | A45F 5/00 224/191 |
| 2017/0329206 | A1 * | 11/2017 | Gustaveson, II | | H04N 5/2257 |
| 2019/0179212 | A1 * | 6/2019 | Leimer | | G03B 11/043 |

* cited by examiner

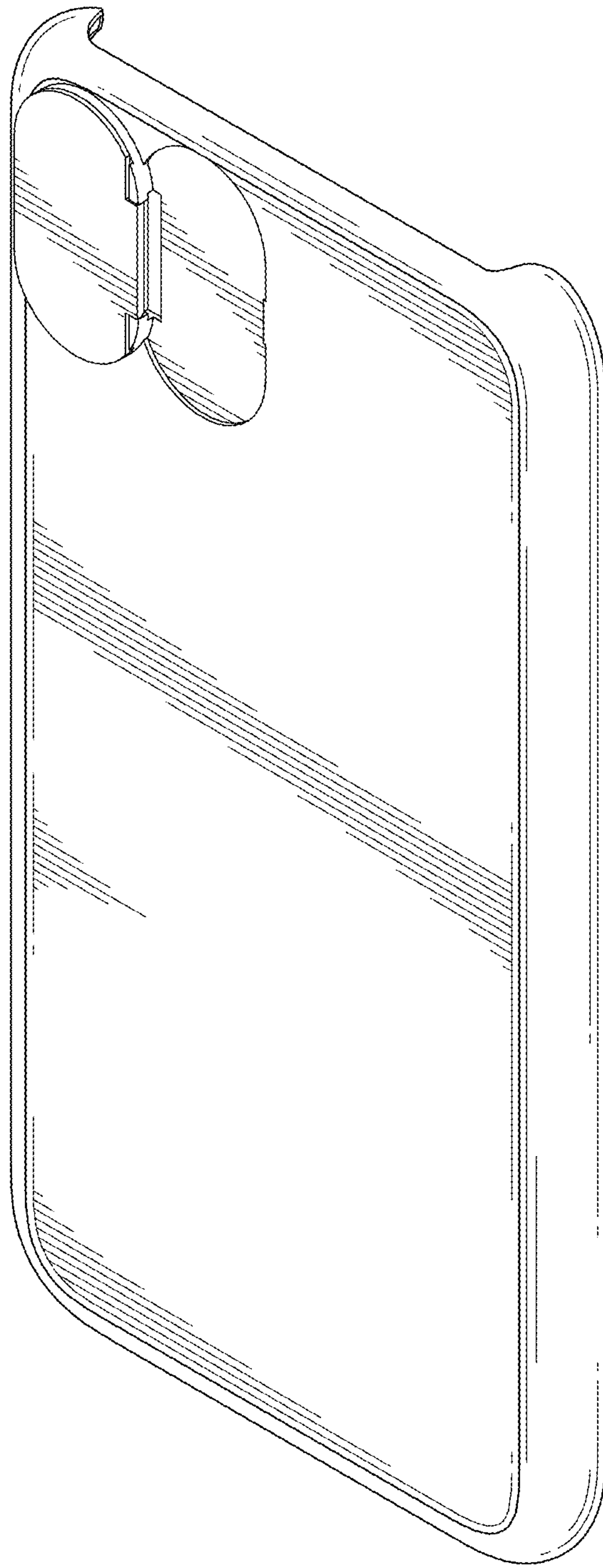

FIG.1

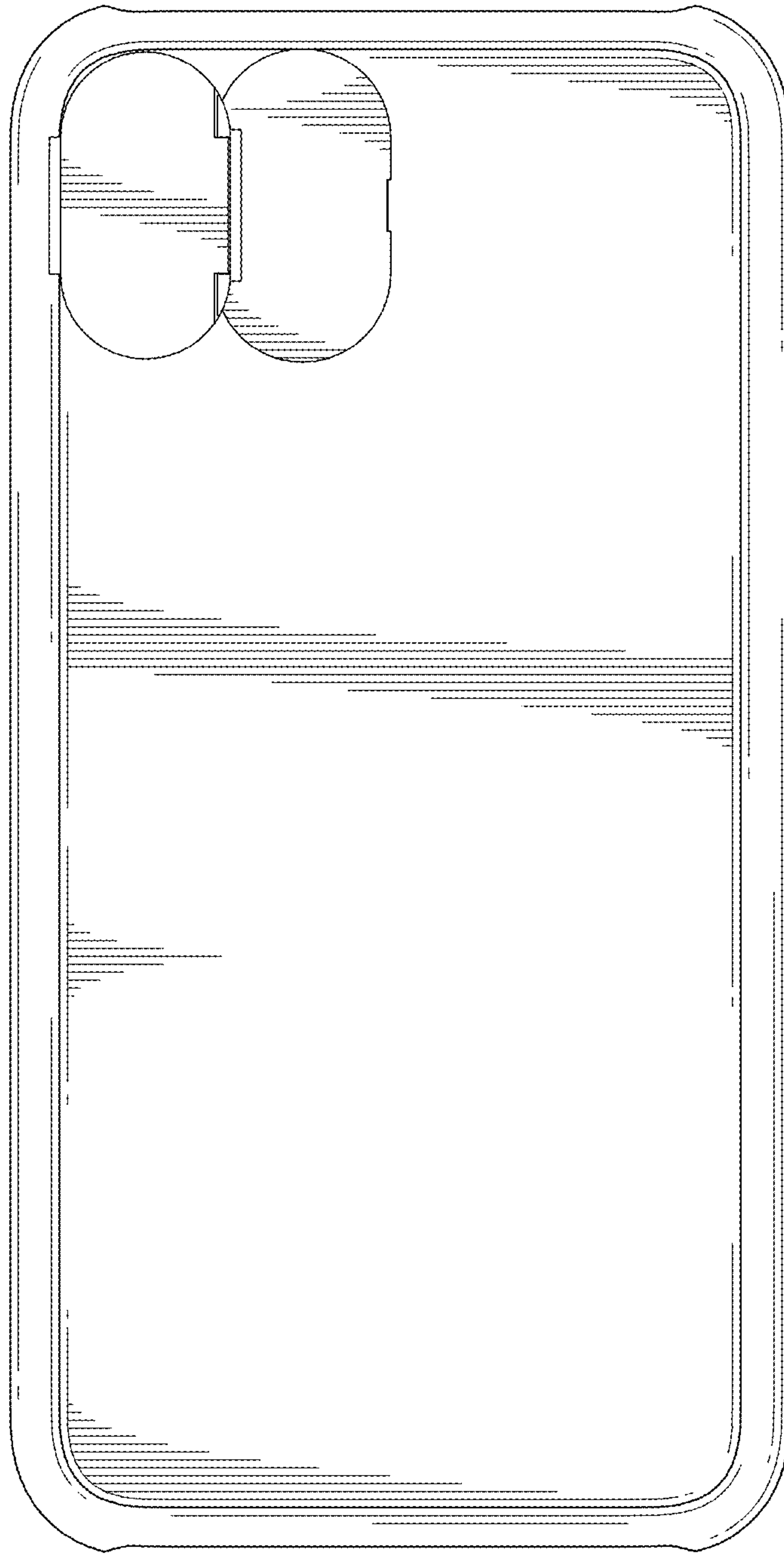

FIG.2

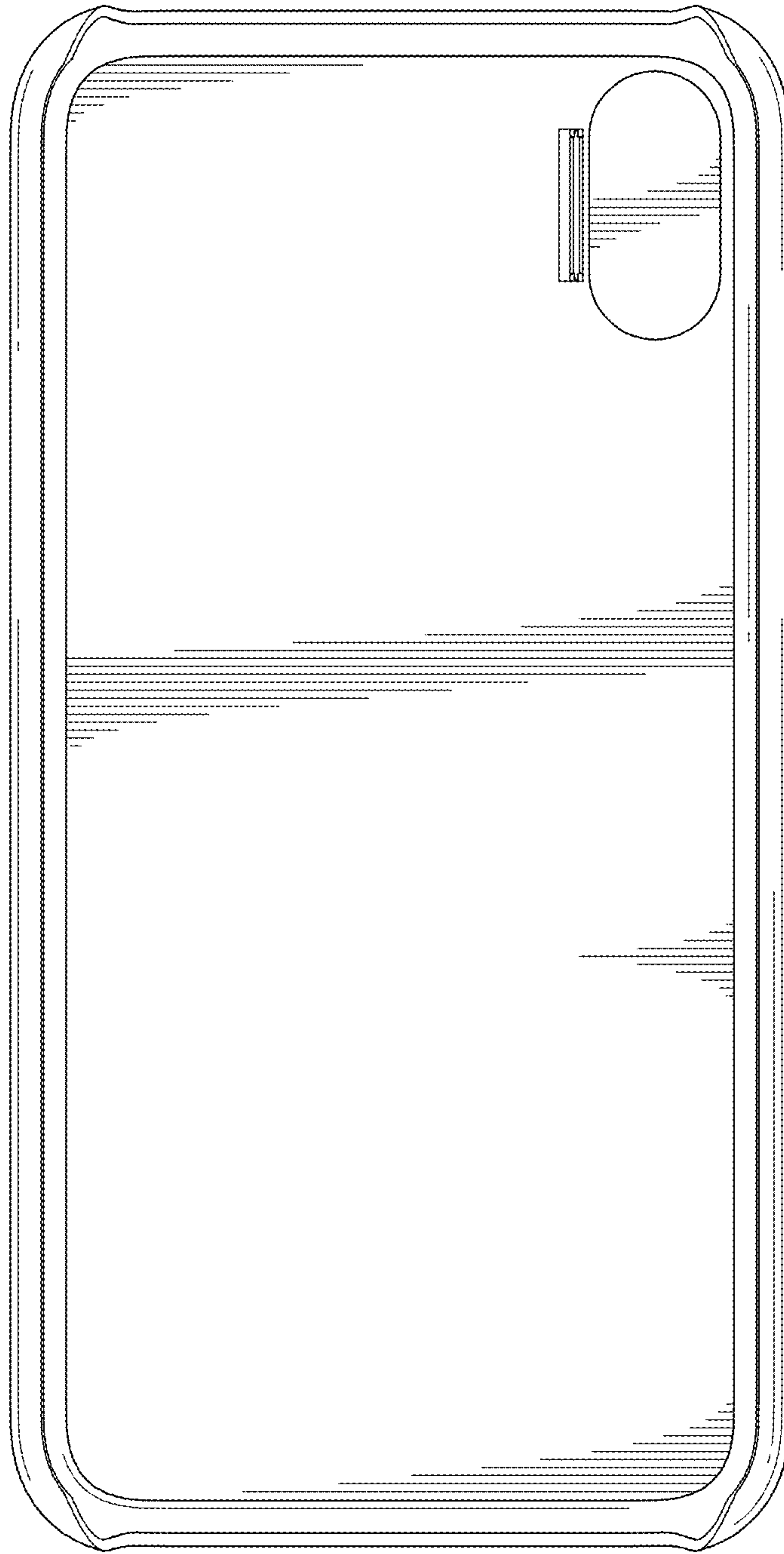

FIG.3

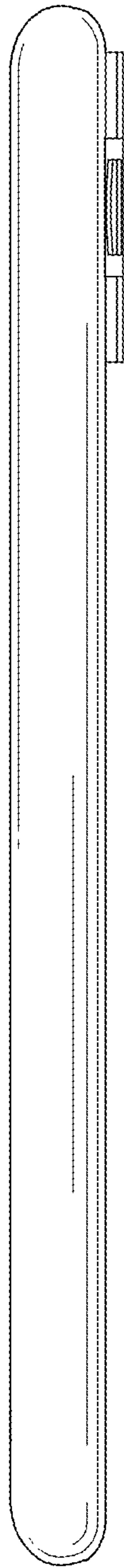

FIG.4

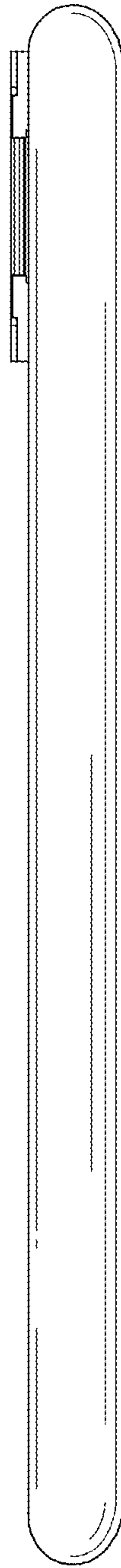

FIG.5

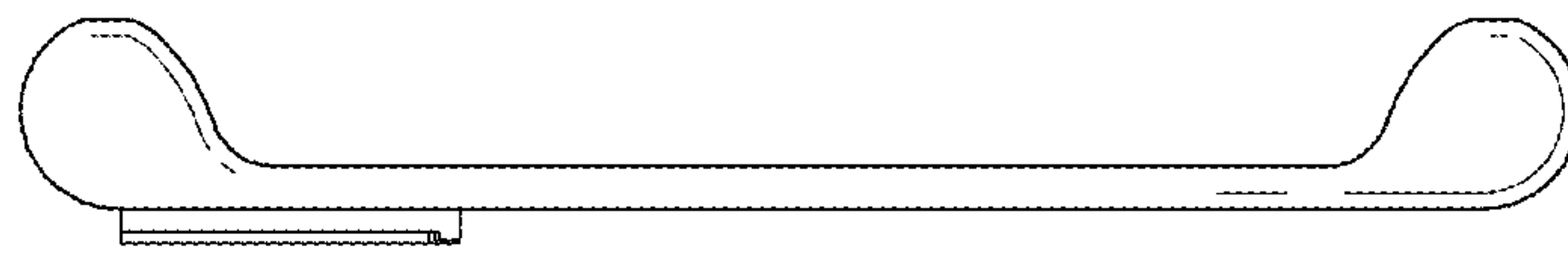

FIG.6

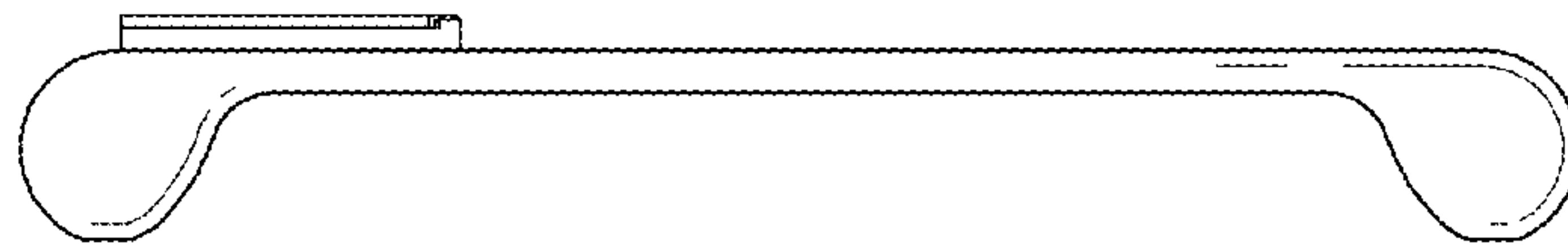

FIG.7

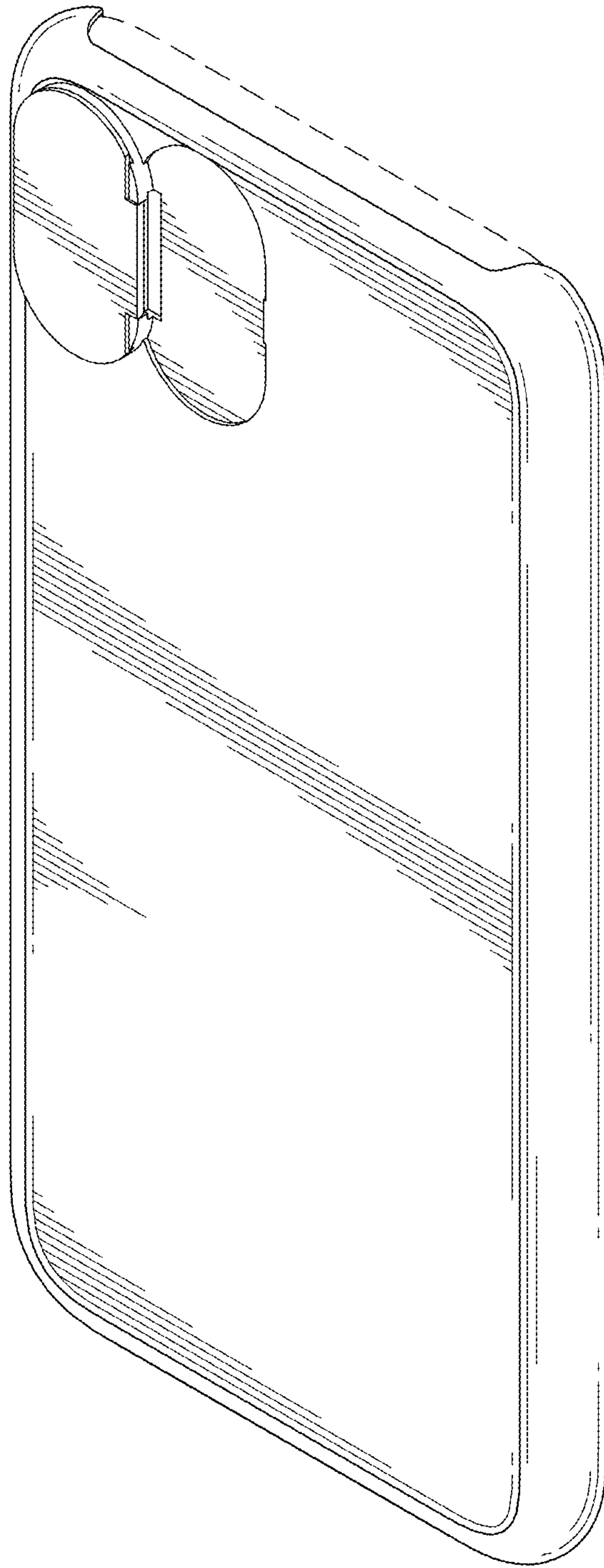

FIG. 8

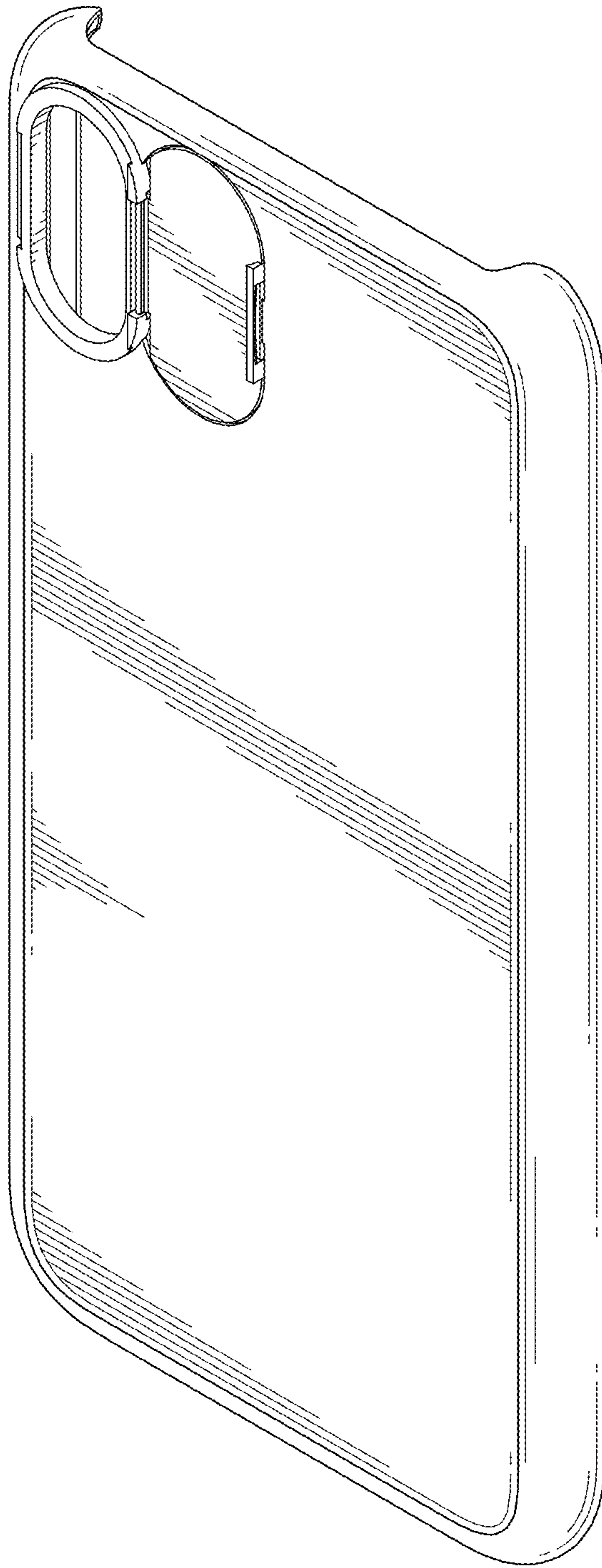

FIG.9

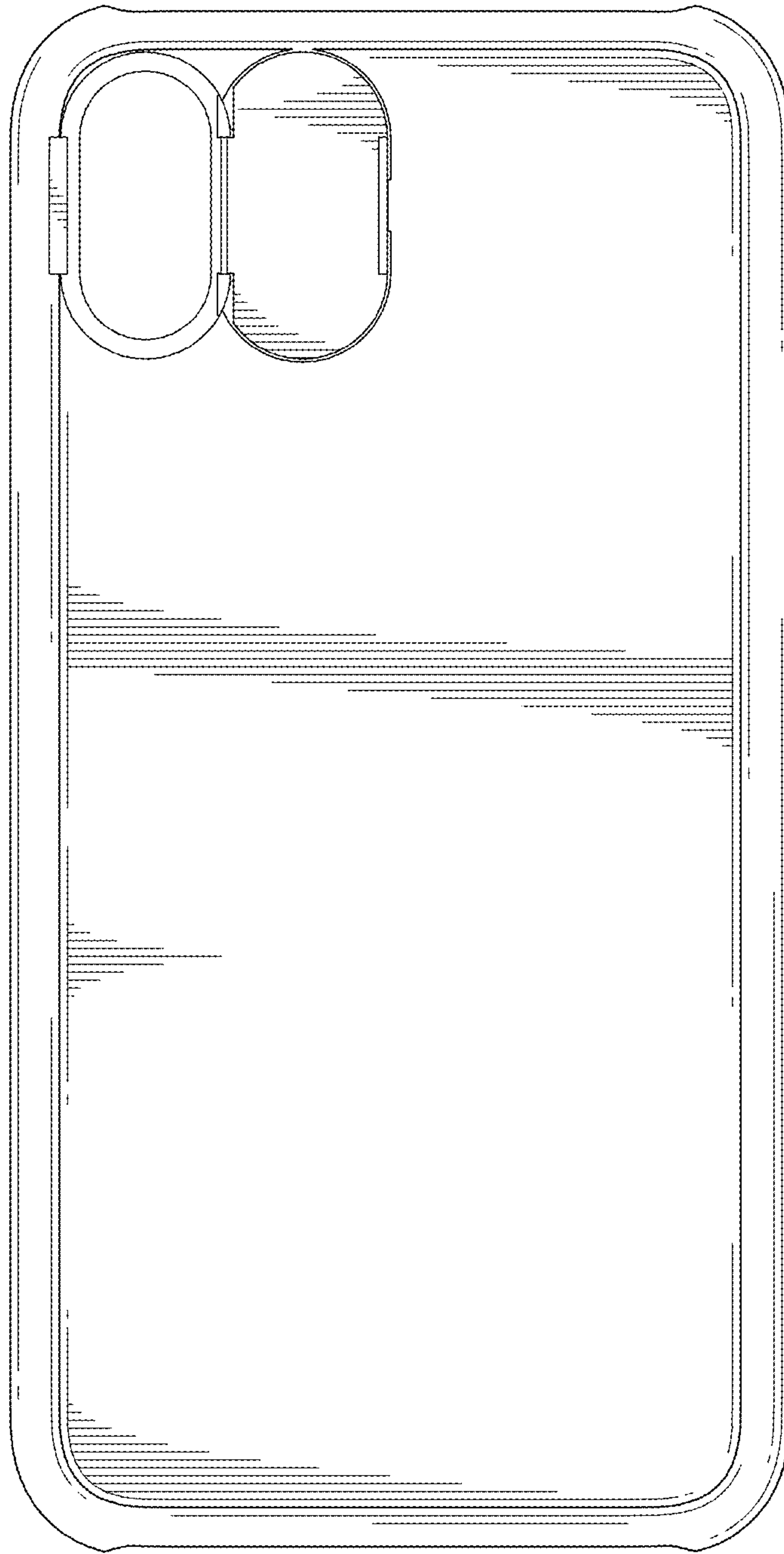

FIG.10

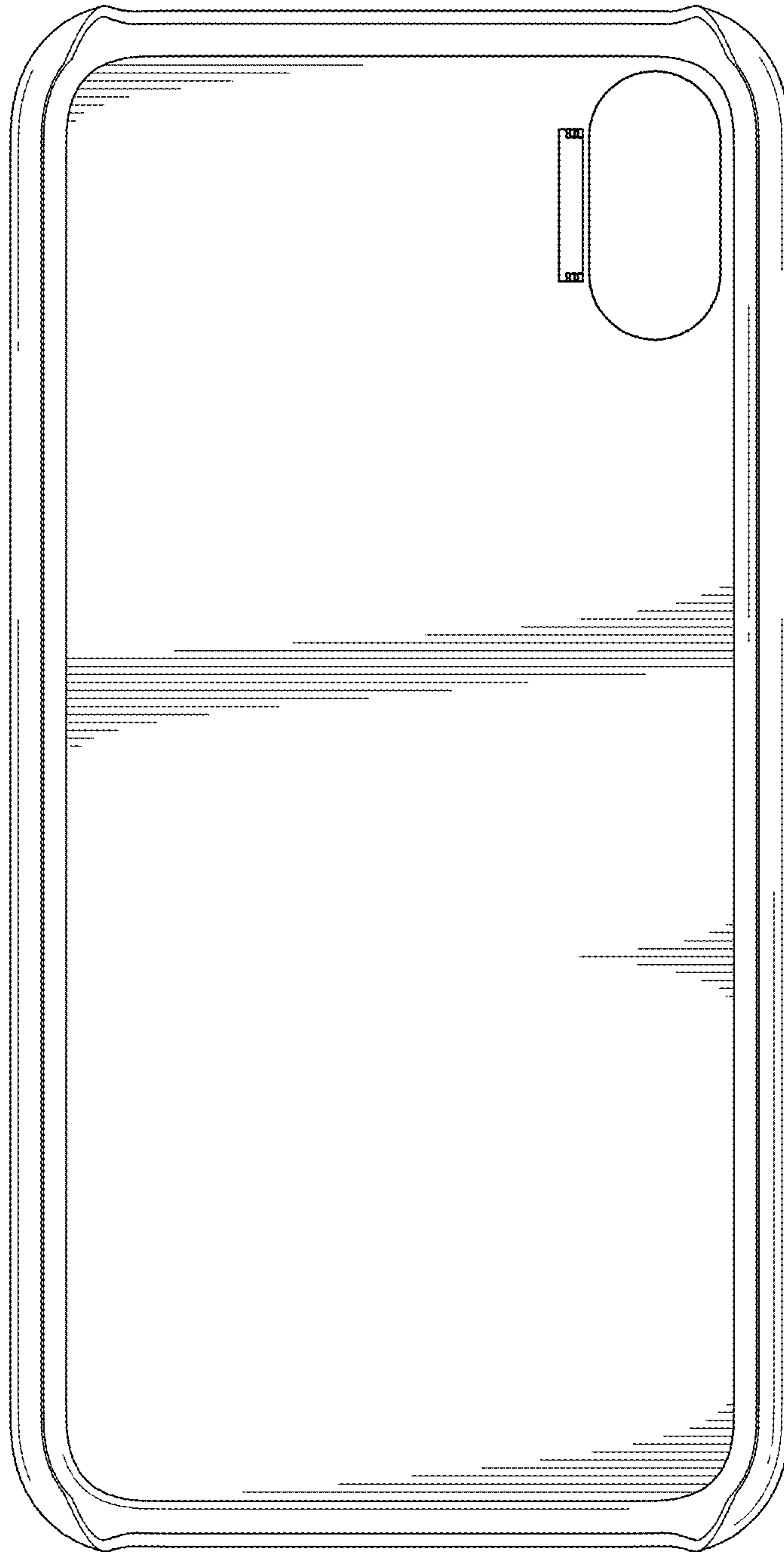

FIG.11

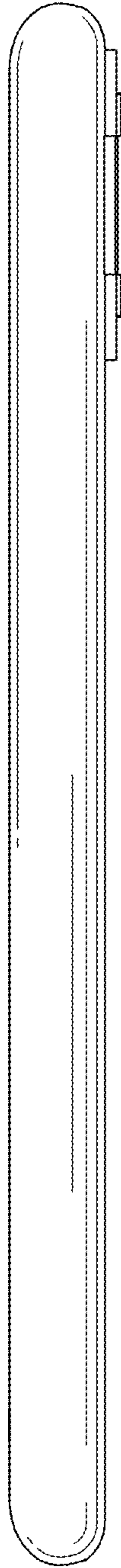

FIG.12

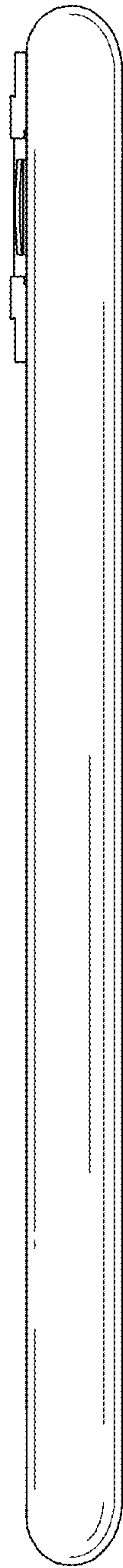

FIG.13

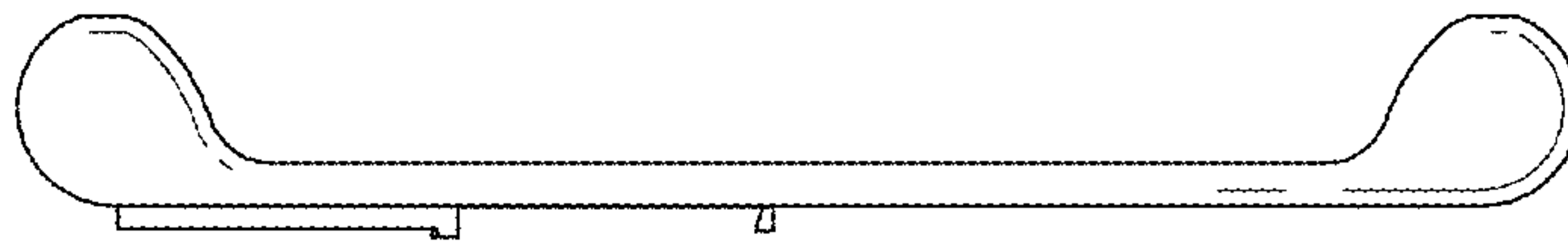

FIG.14

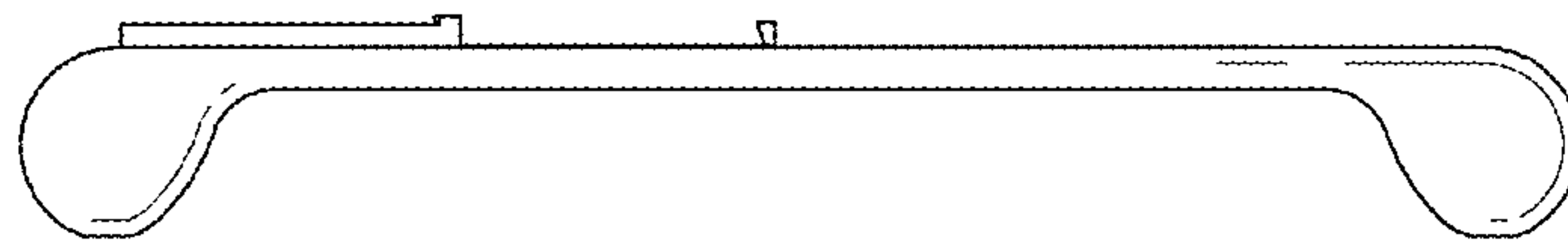

FIG.15

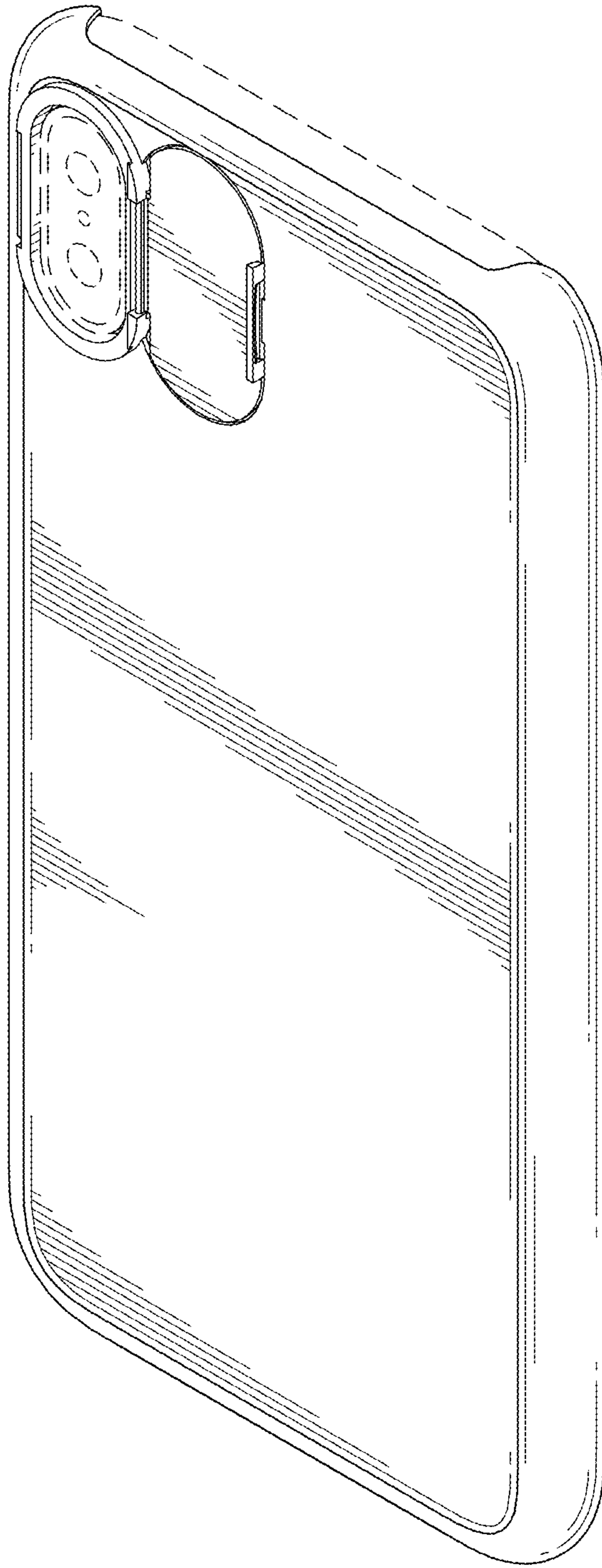

FIG.16

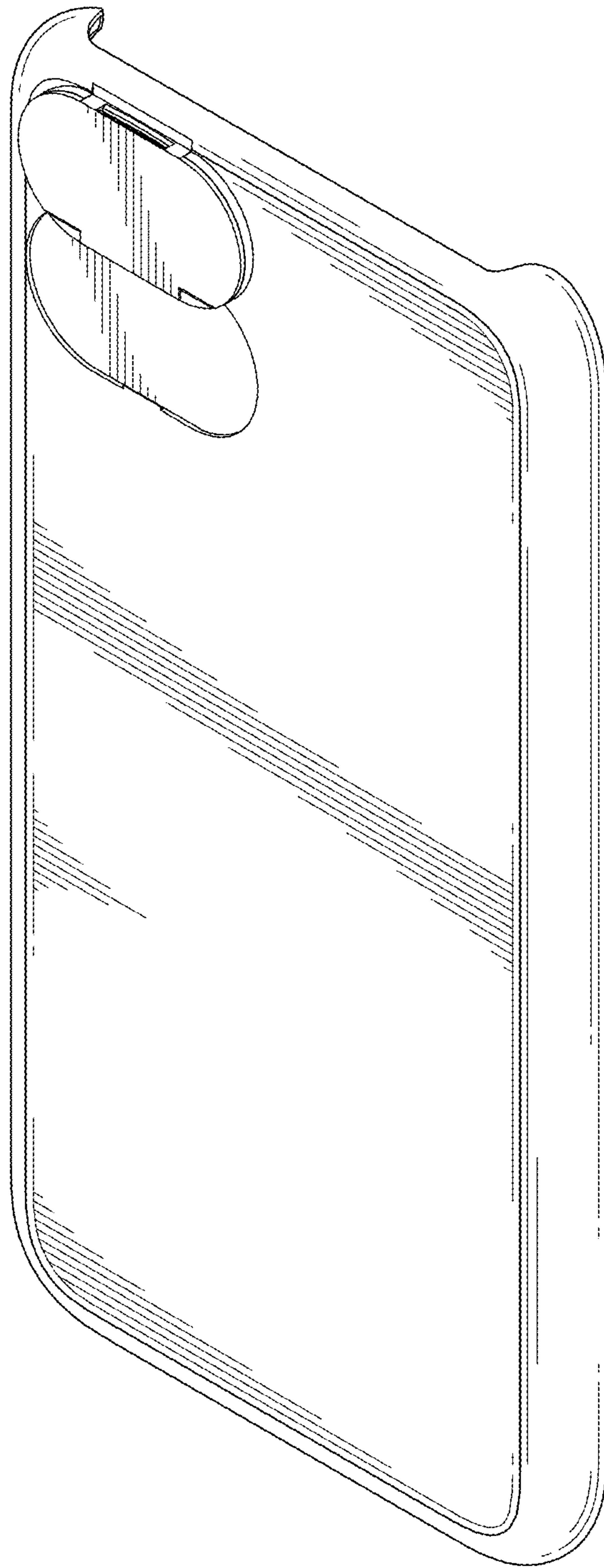

FIG.17

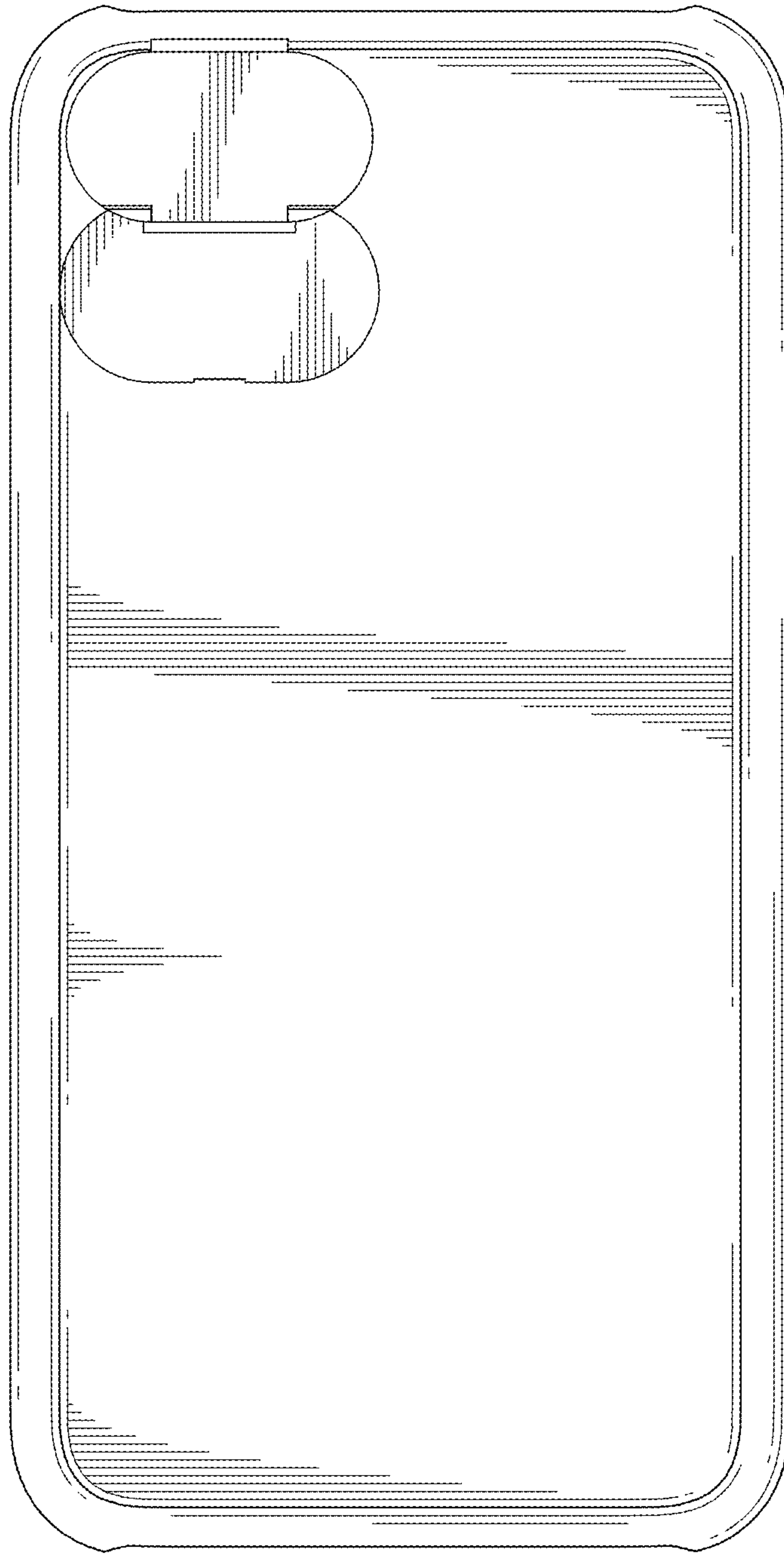

FIG.18

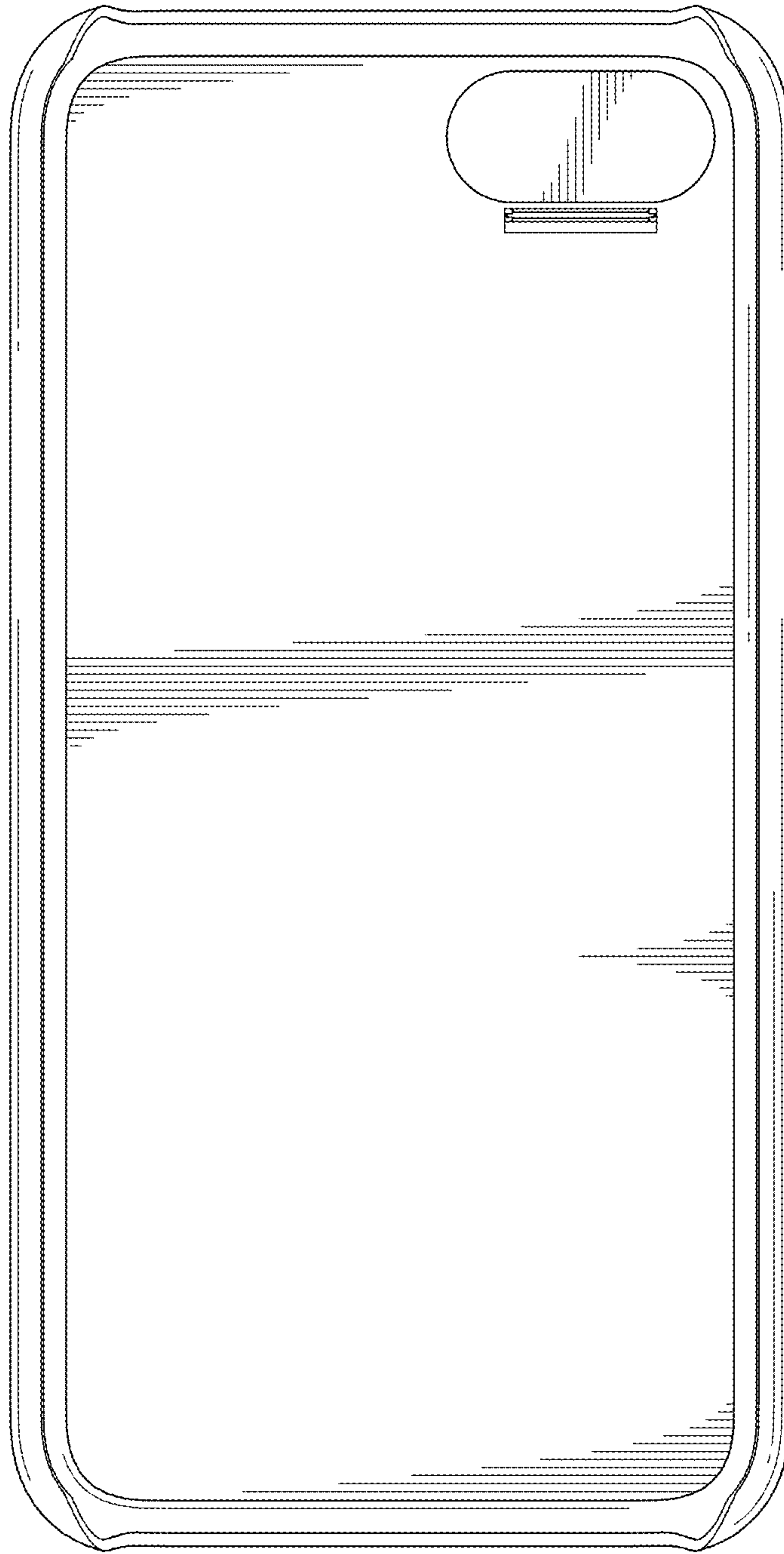

FIG.19

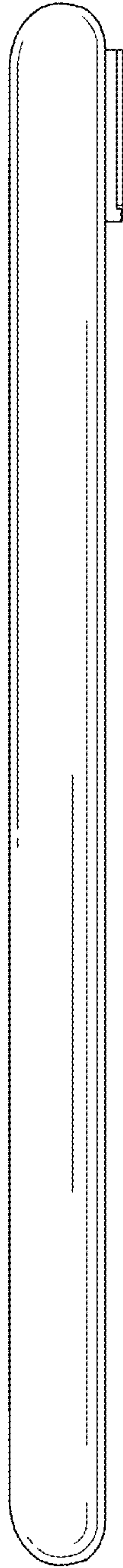

FIG.20

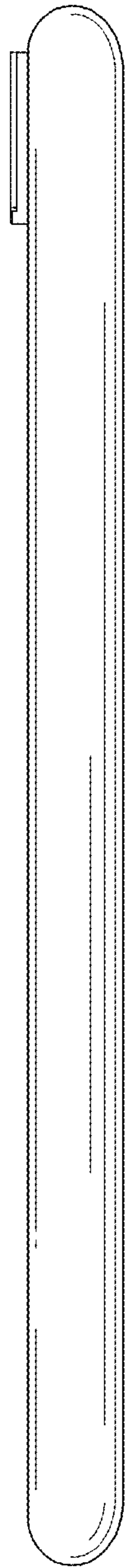

FIG.21

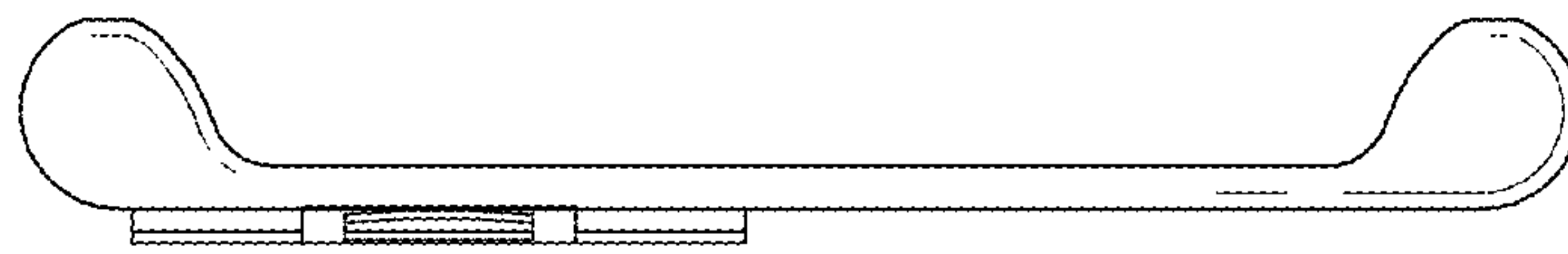

FIG.22

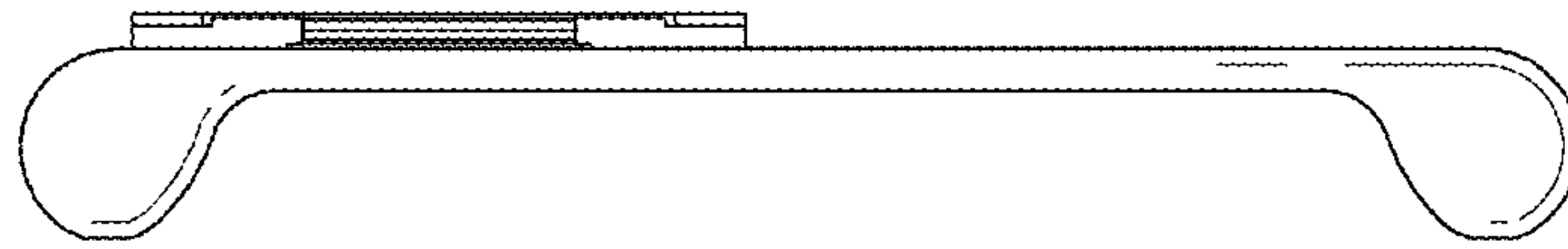

FIG.23

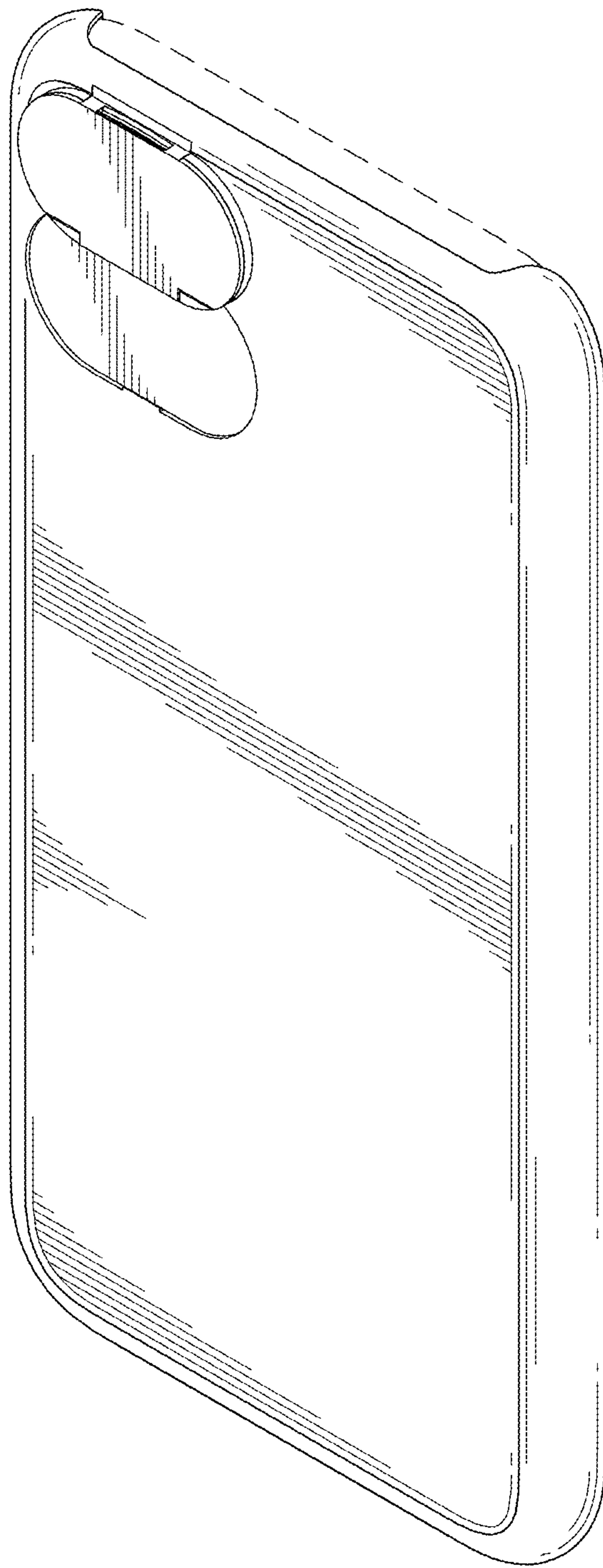

FIG.24

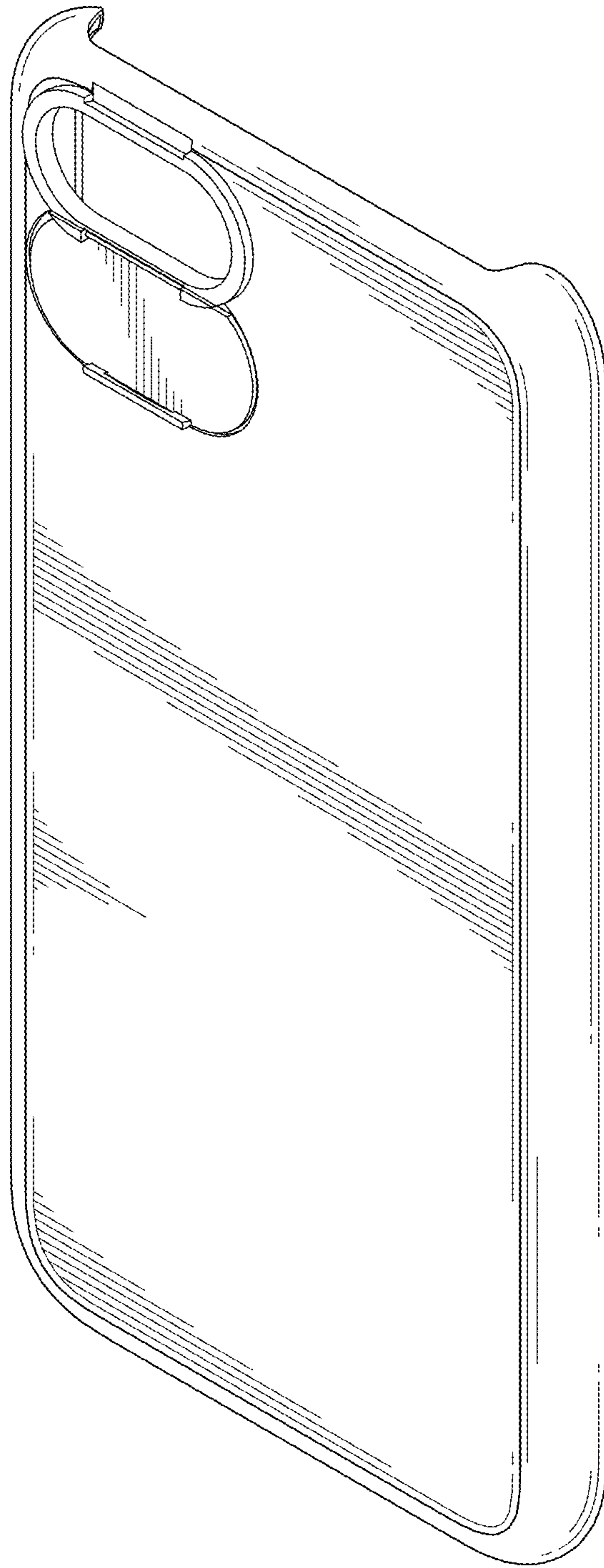

FIG.25

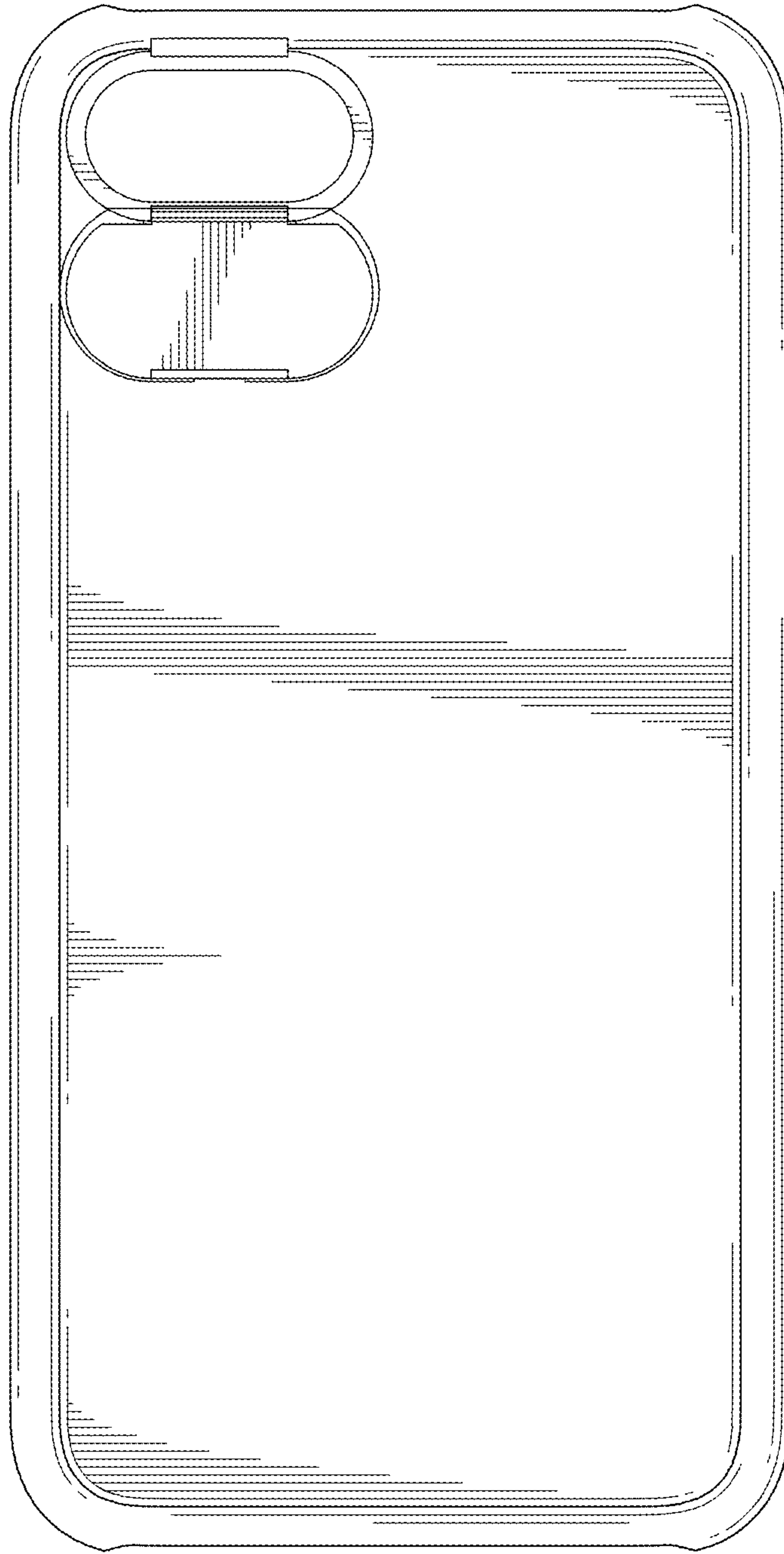

FIG. 26

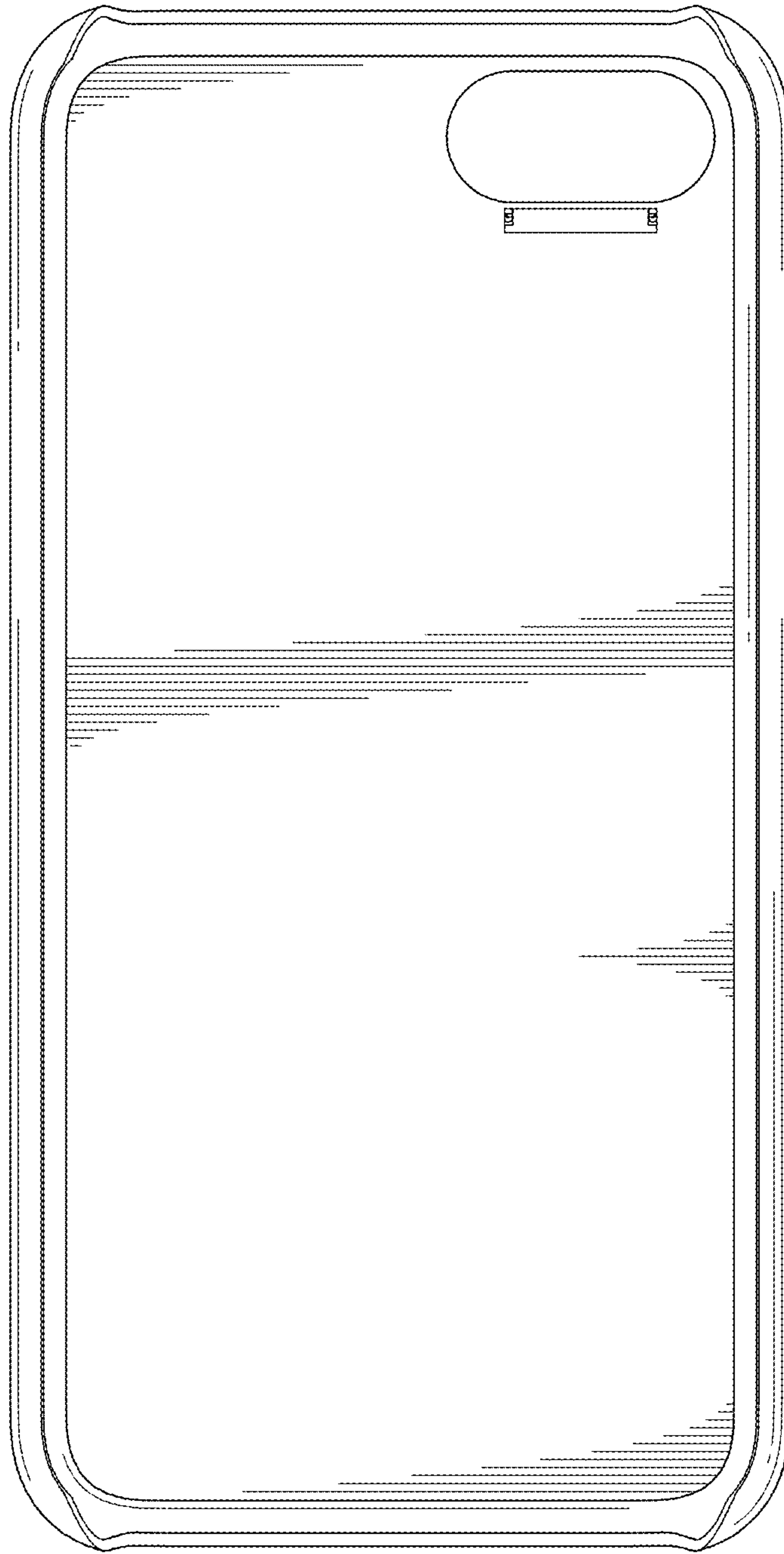

FIG.27

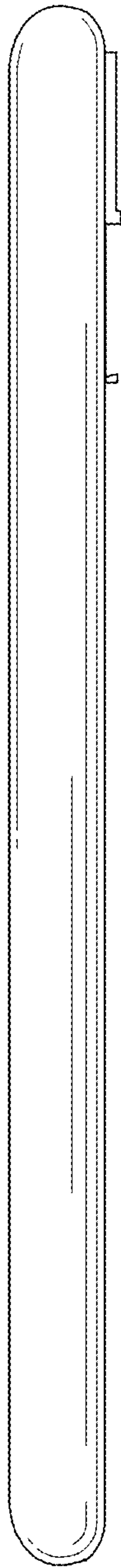

FIG.28

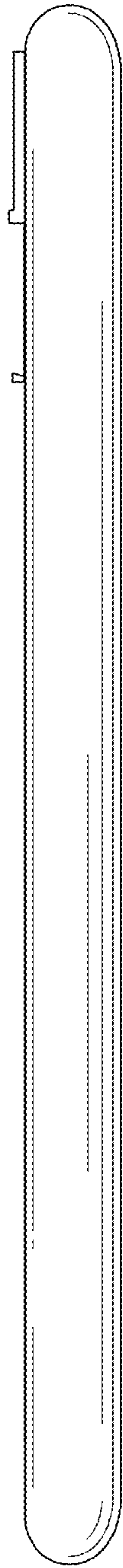

FIG.29

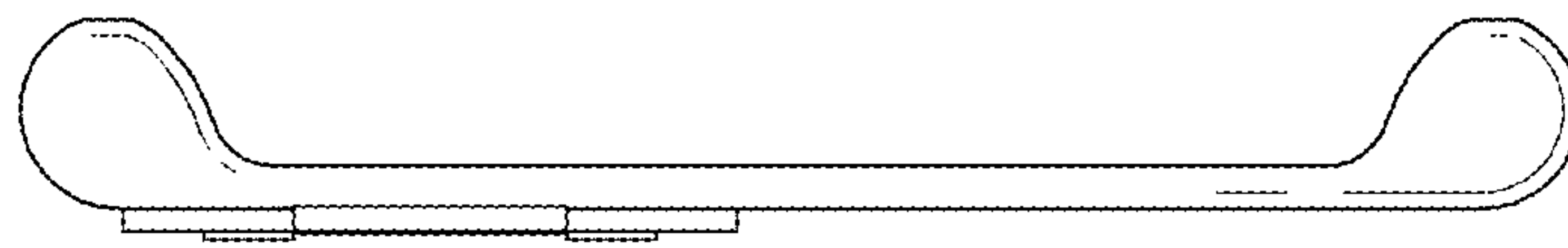

FIG.30

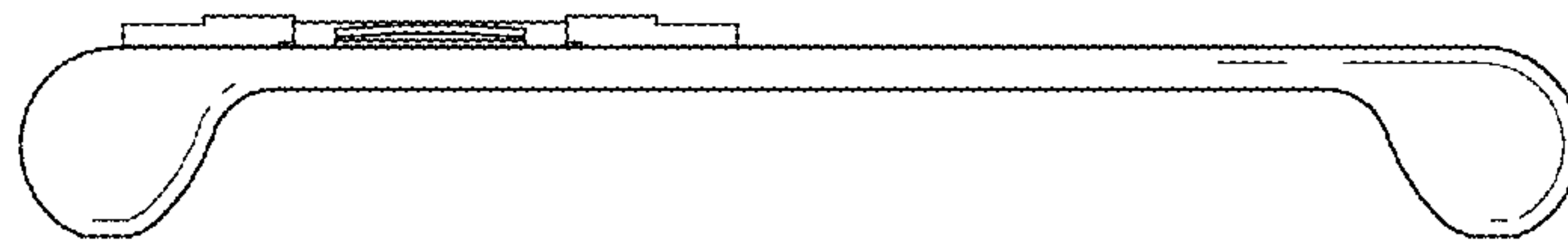

FIG.31

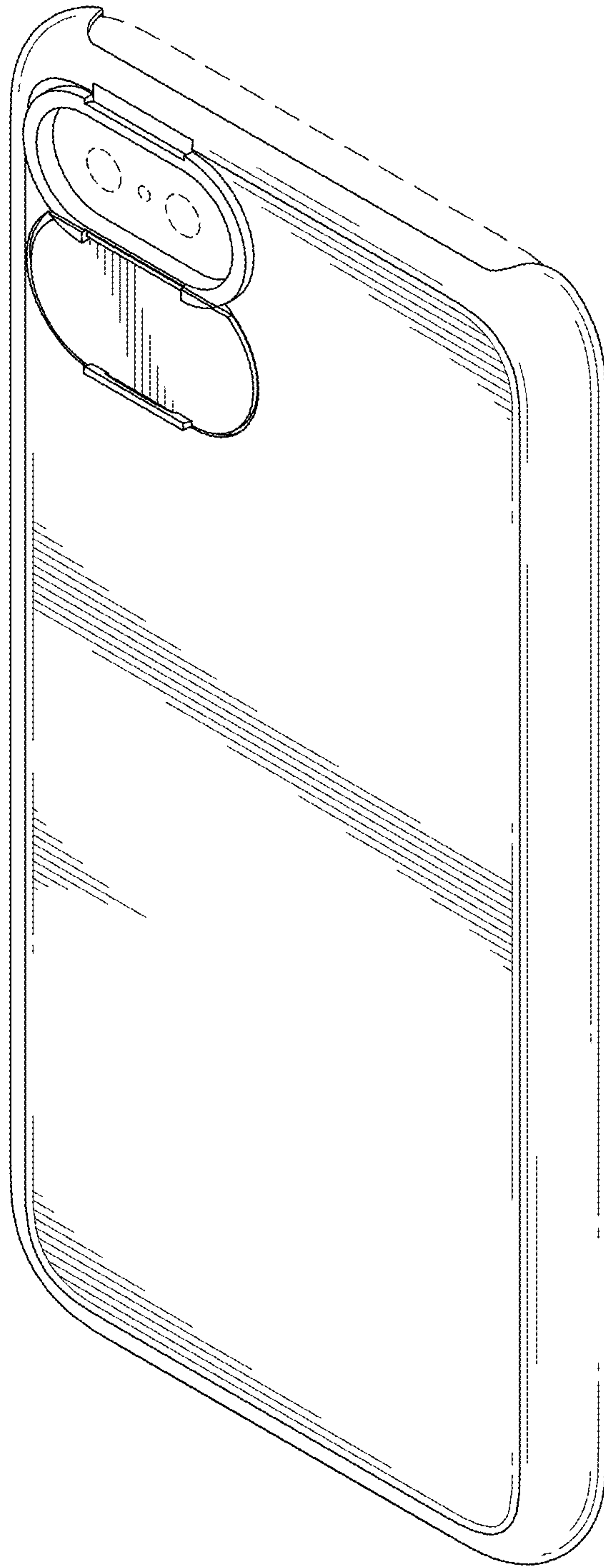

FIG.32

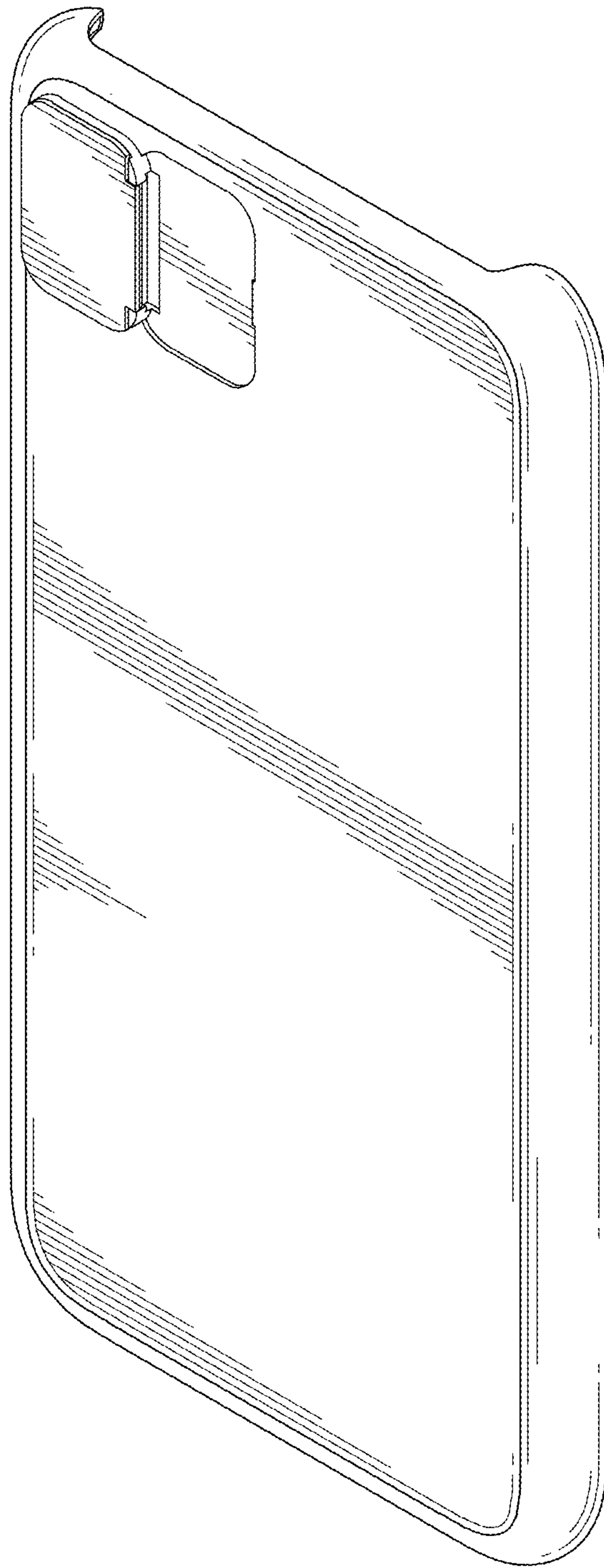

FIG. 33

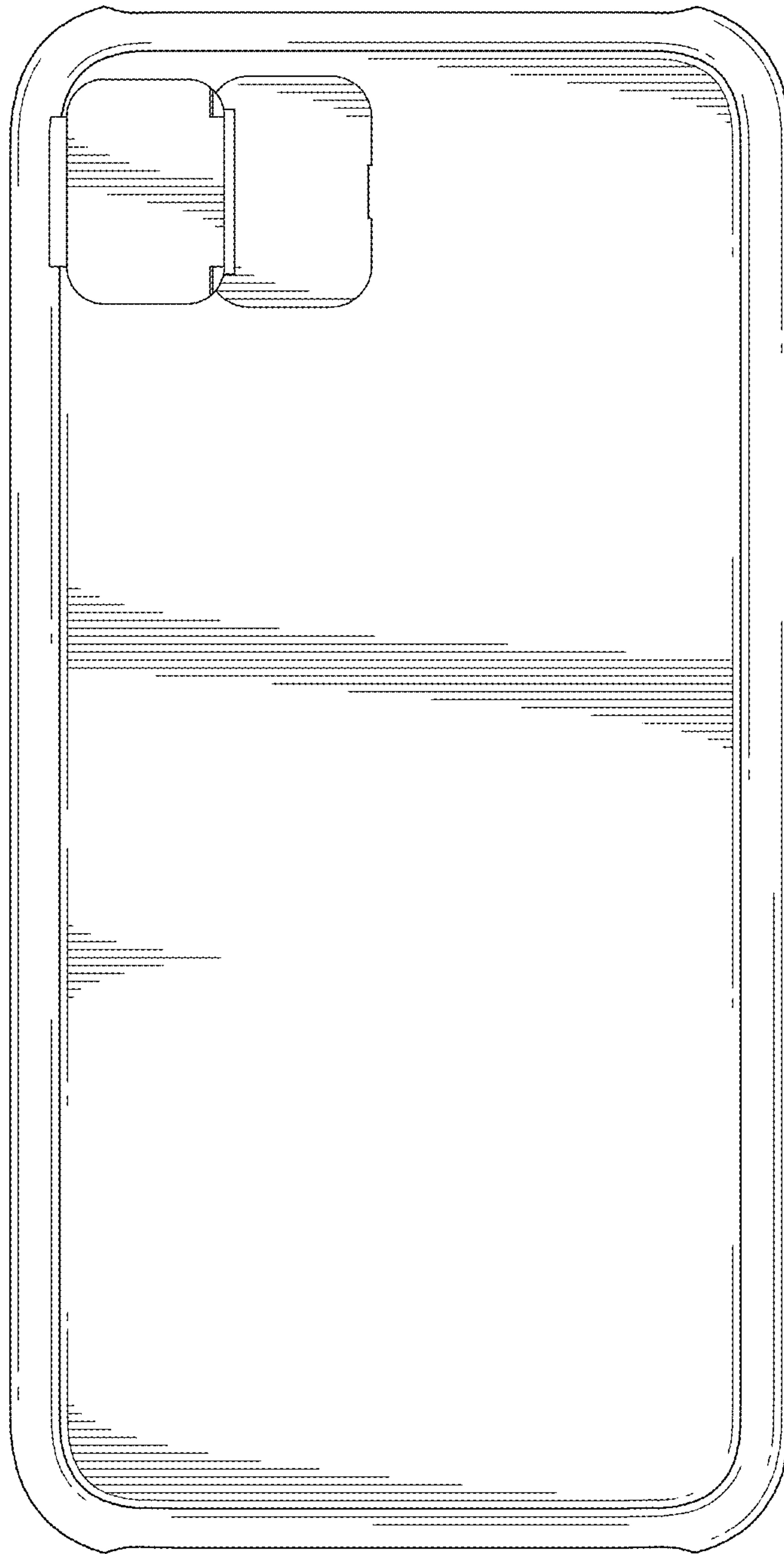

FIG. 34

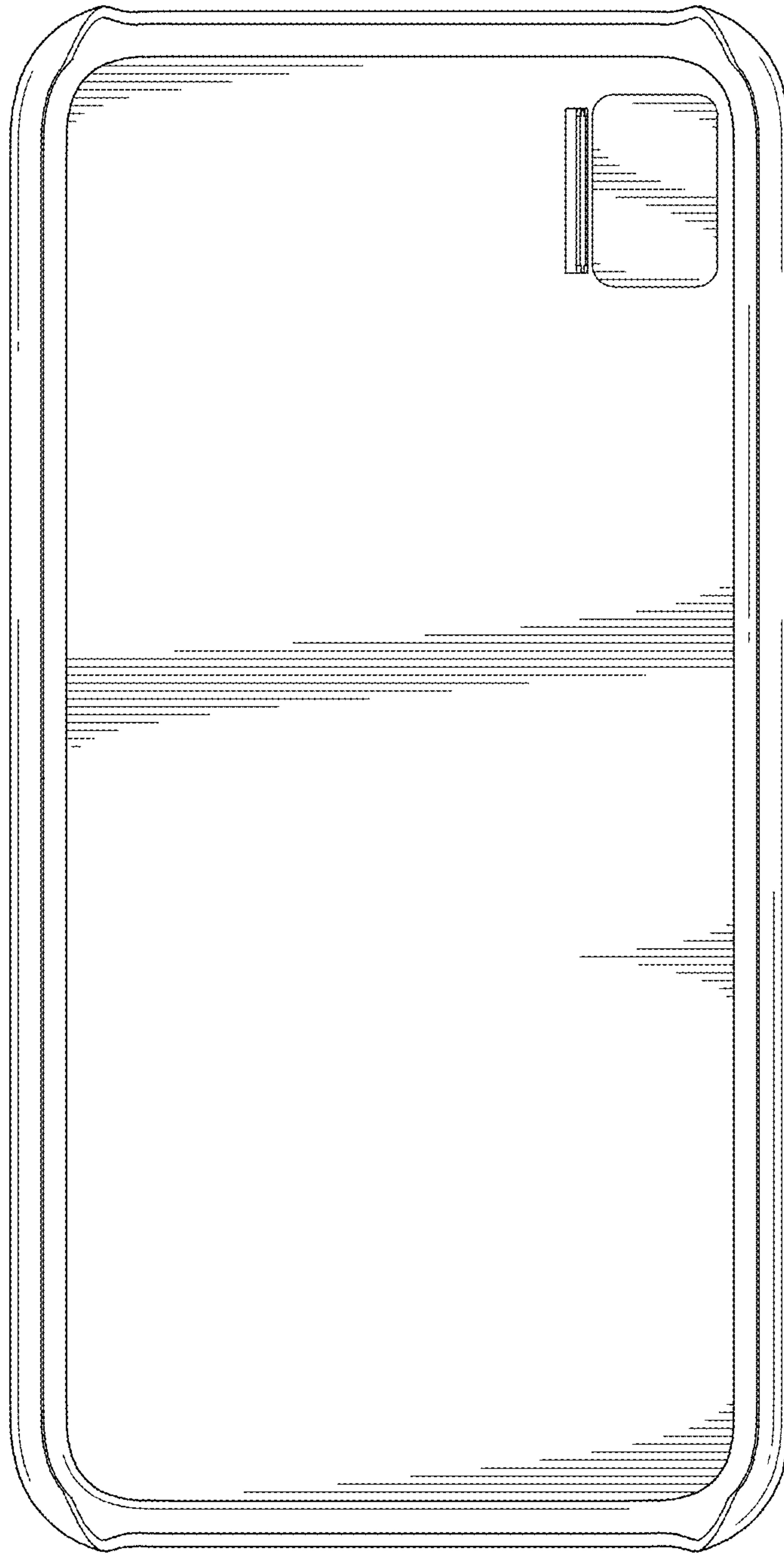

FIG. 35

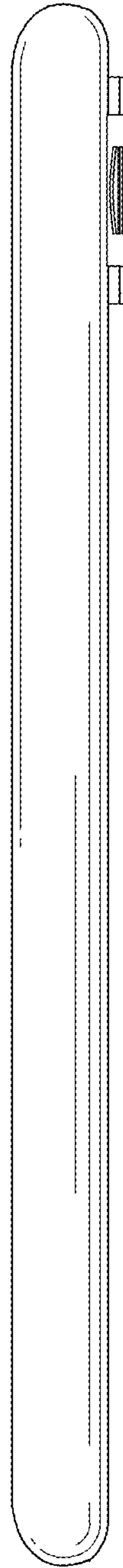

FIG. 36

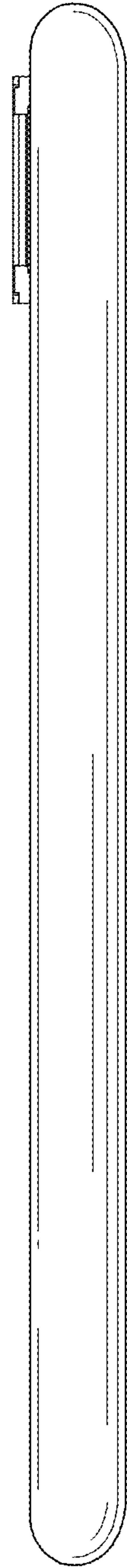

FIG. 37

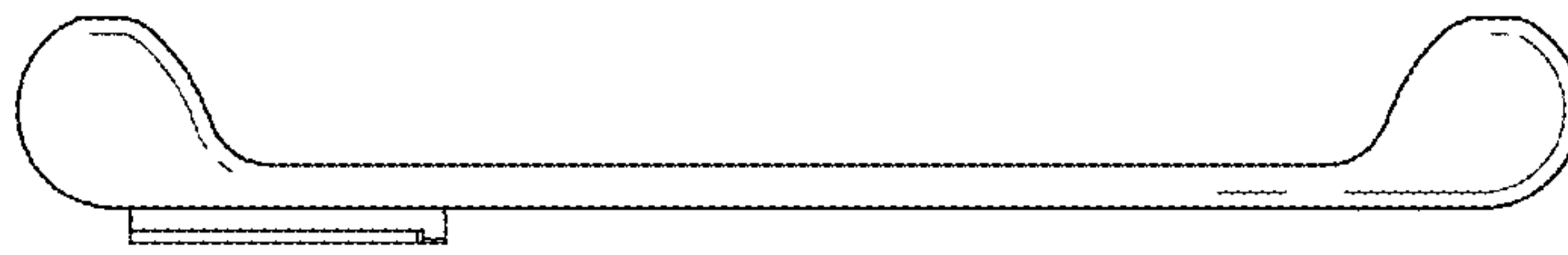

FIG. 38

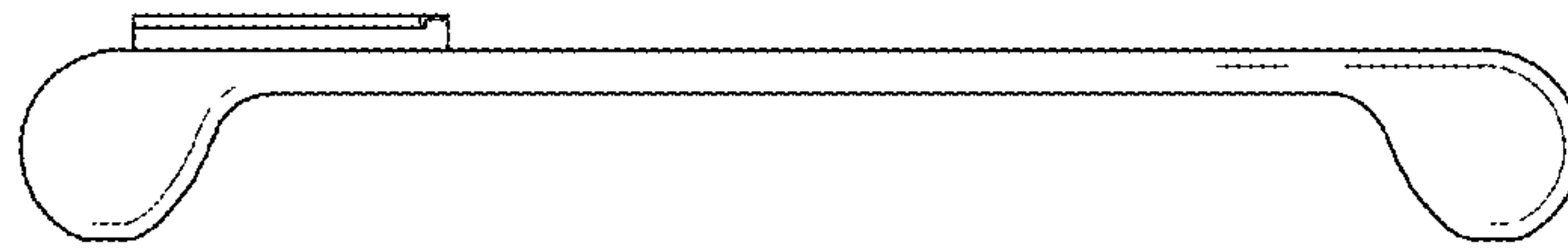

FIG. 39

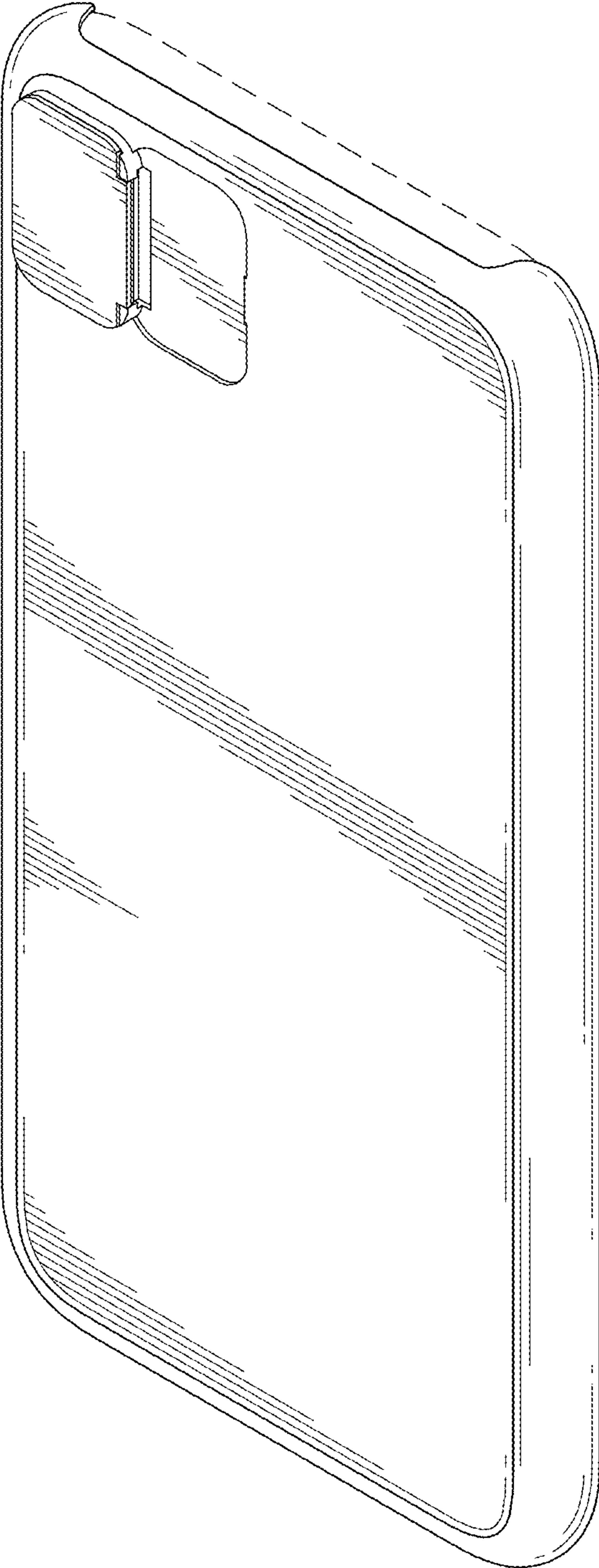

FIG.40

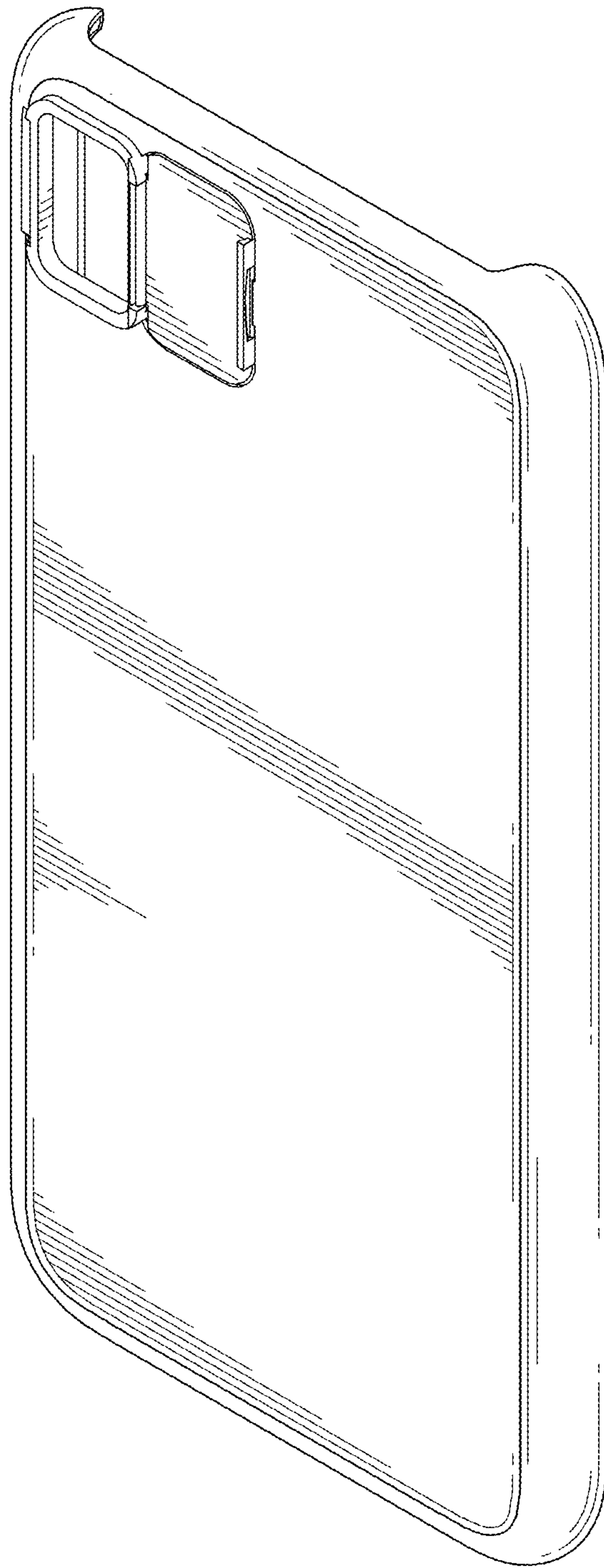

FIG. 41

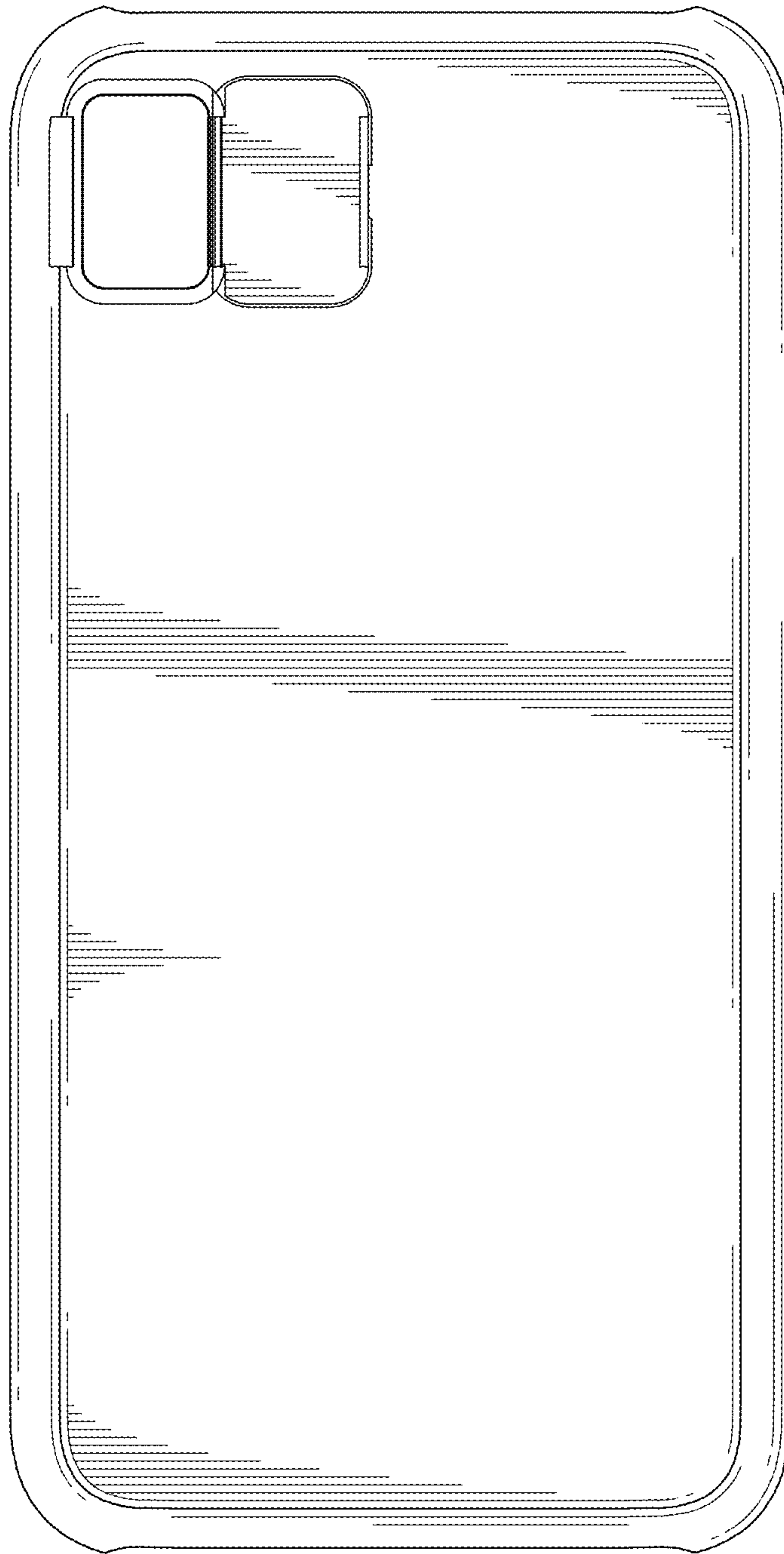

FIG. 42

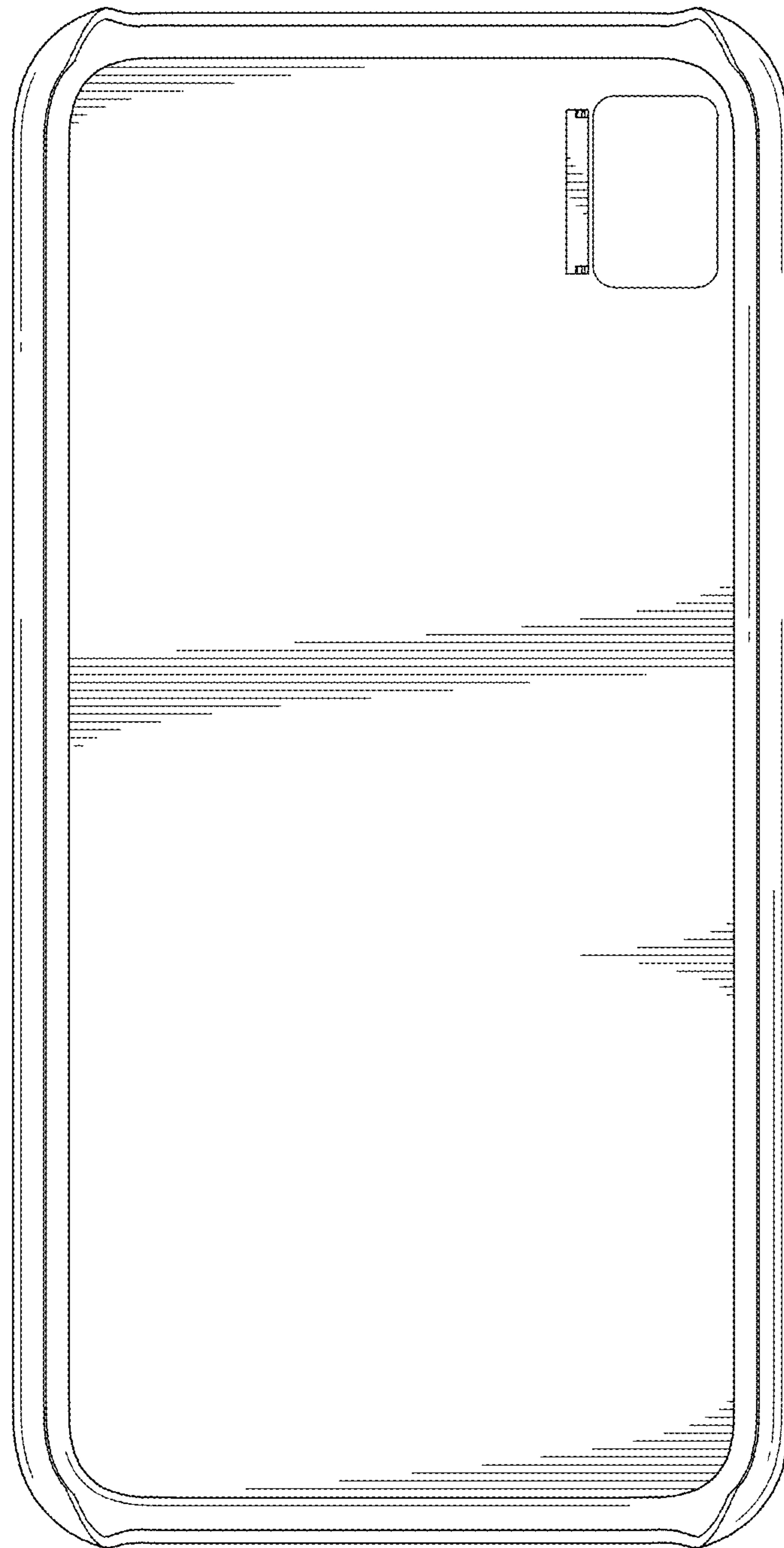

FIG. 43

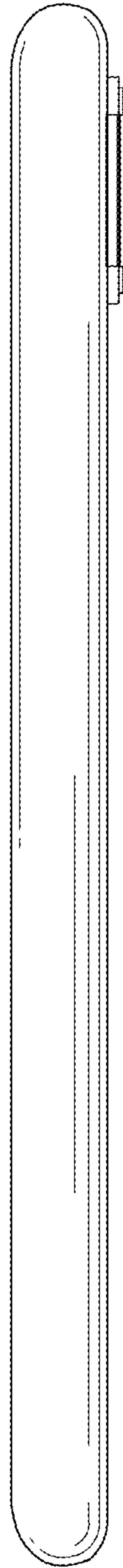

FIG. 44

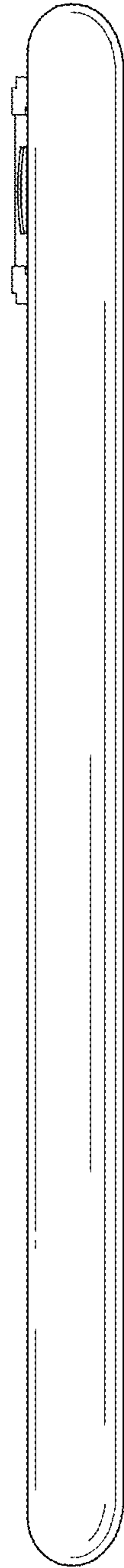

FIG. 45

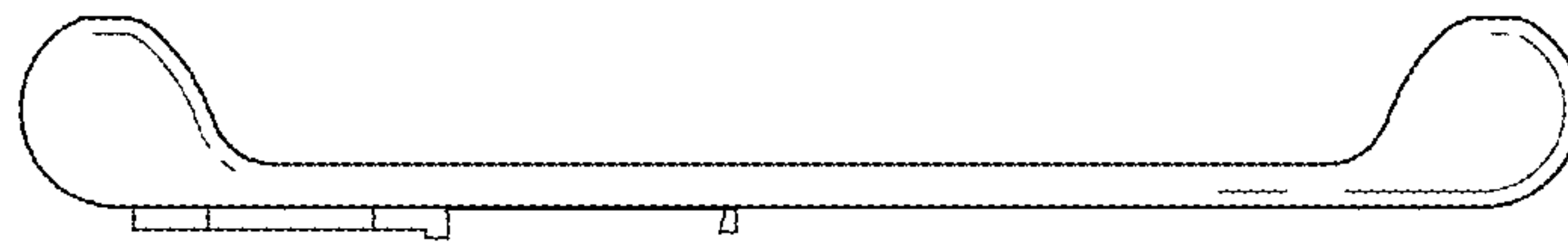

FIG. 46

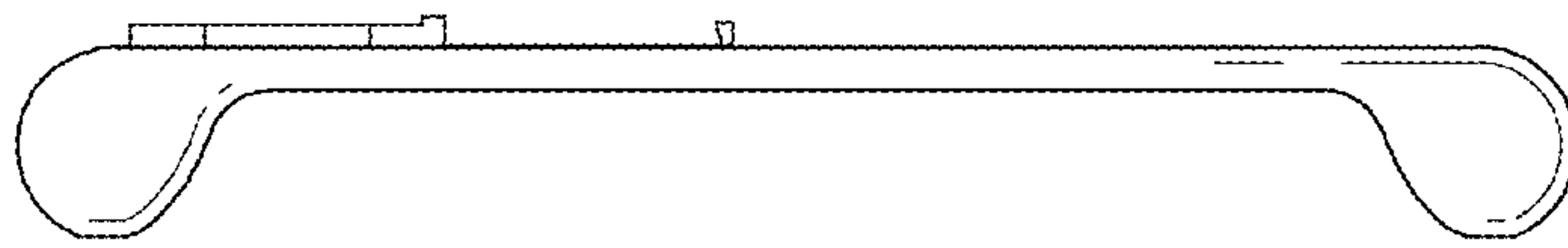

FIG. 47

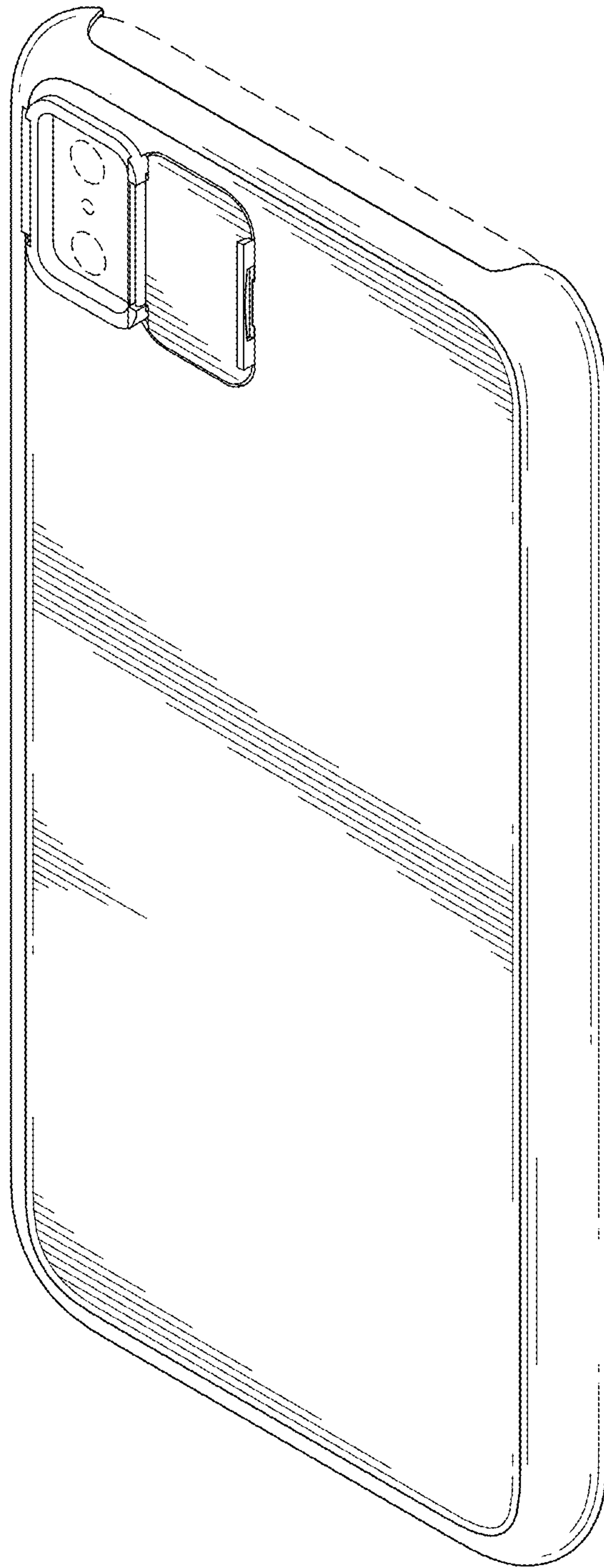

FIG.48

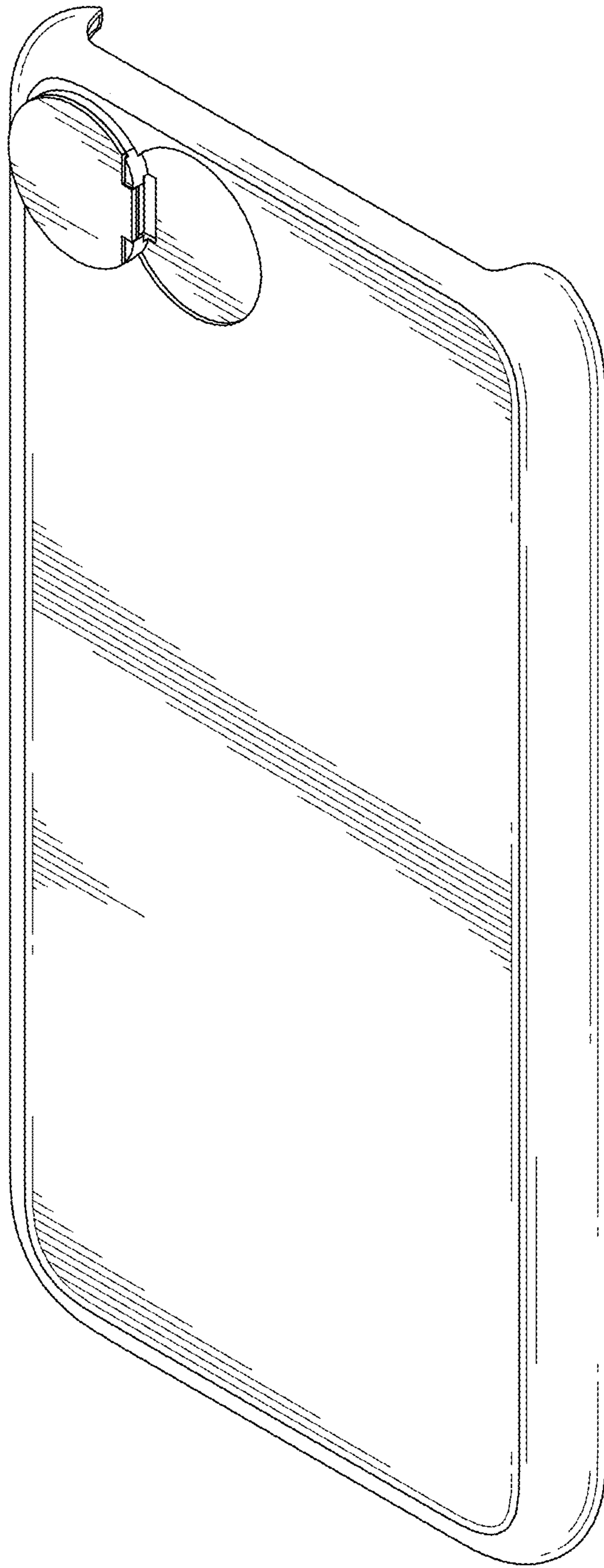

FIG.49

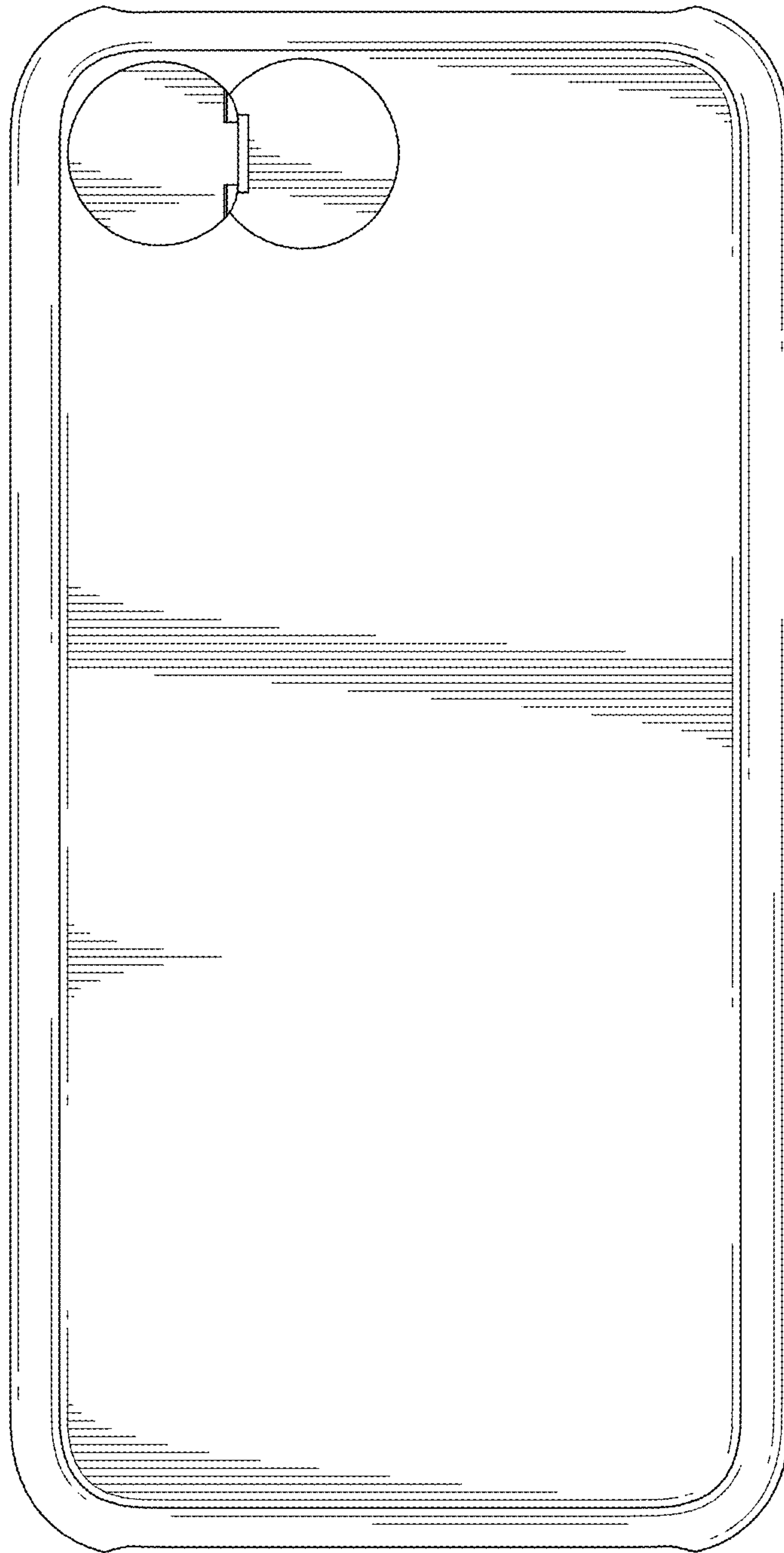

FIG.50

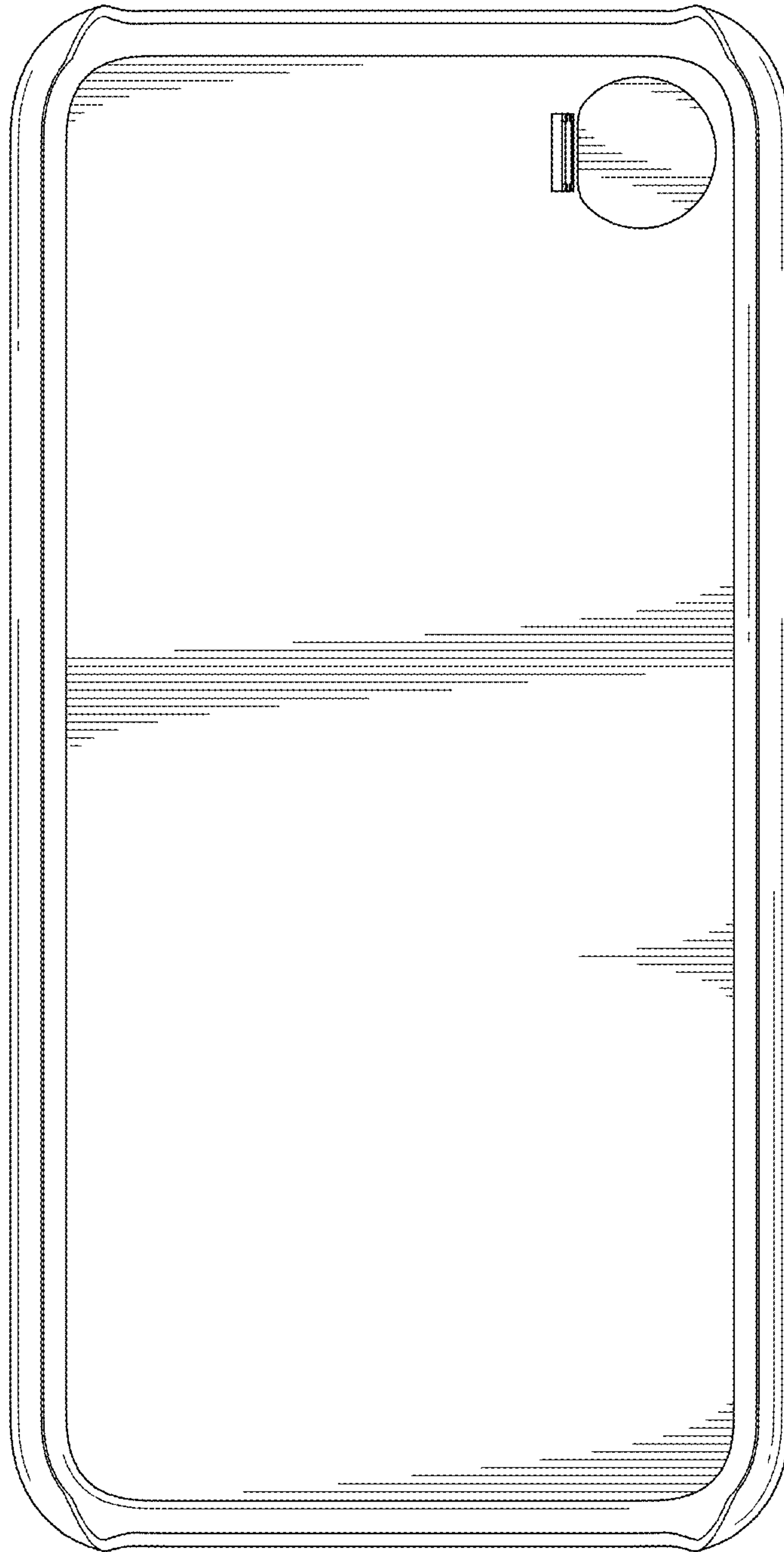

FIG.51

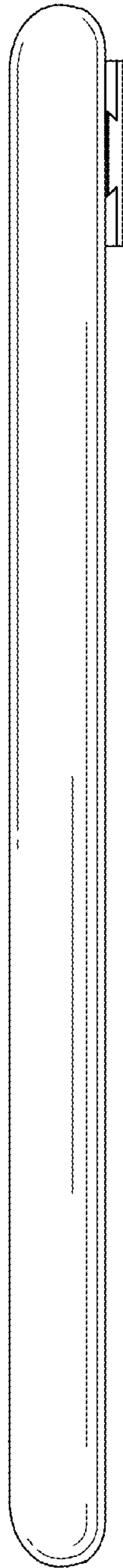

FIG.52

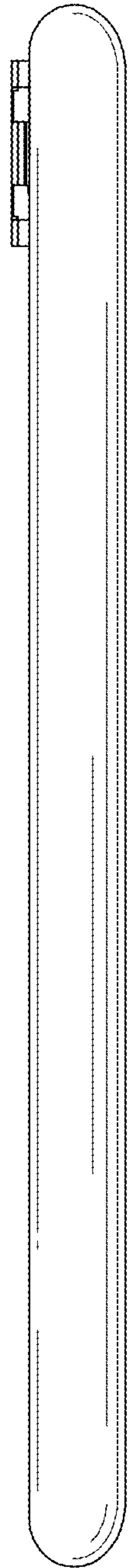

FIG.53

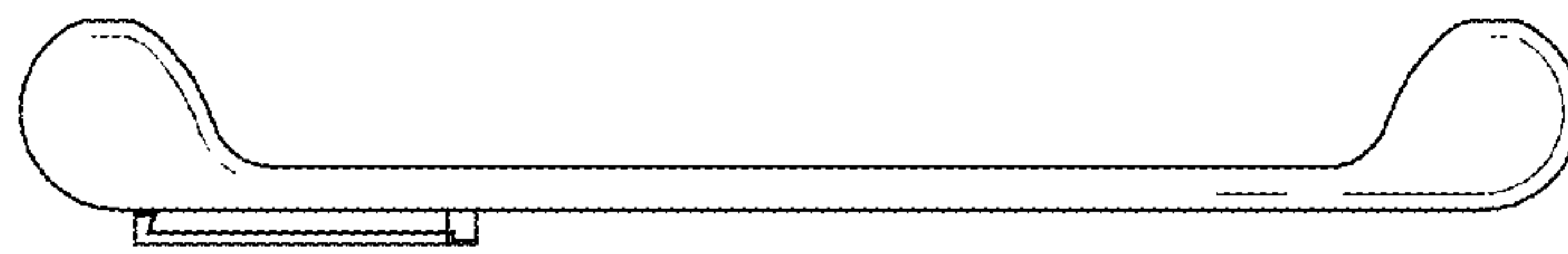

FIG.54

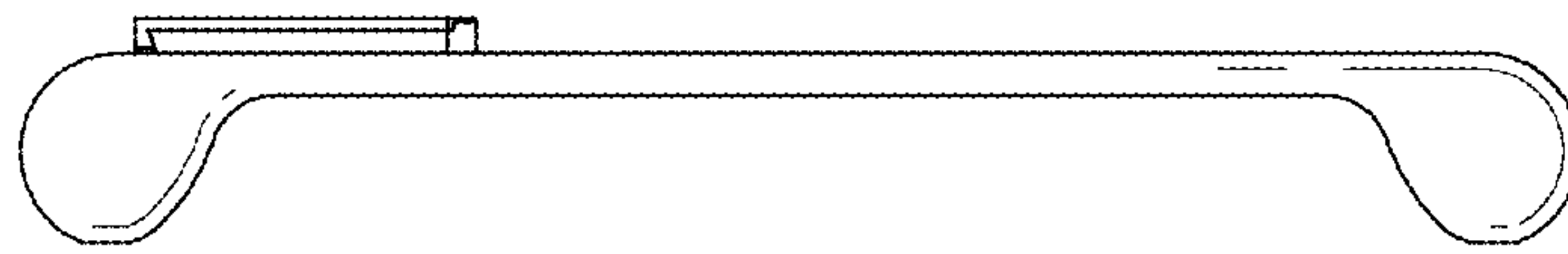

FIG.55

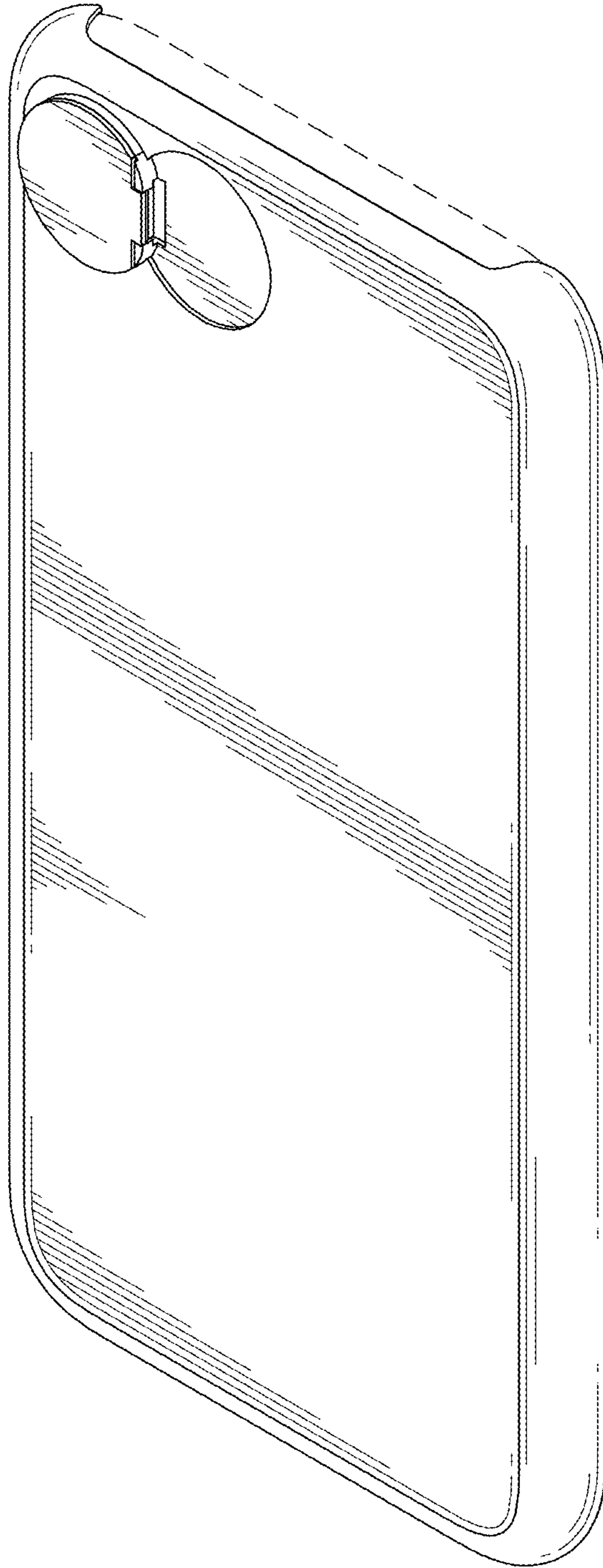

FIG.56

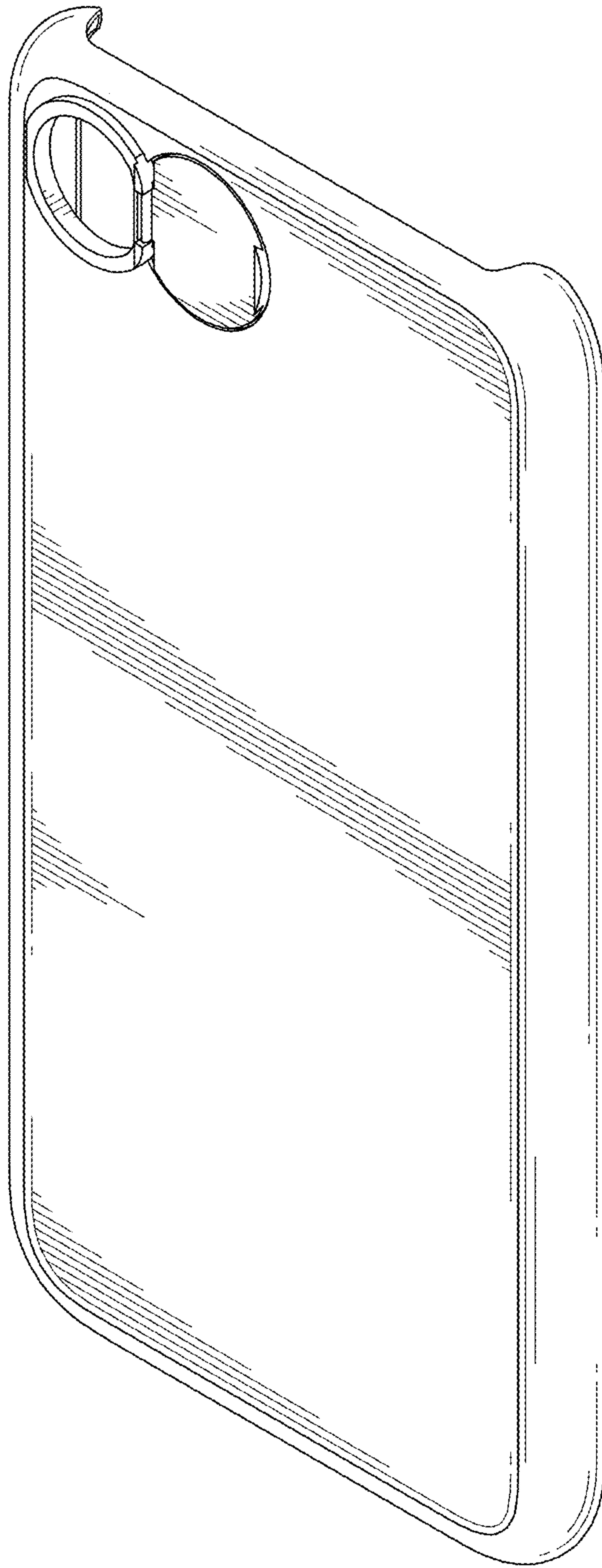

FIG.57

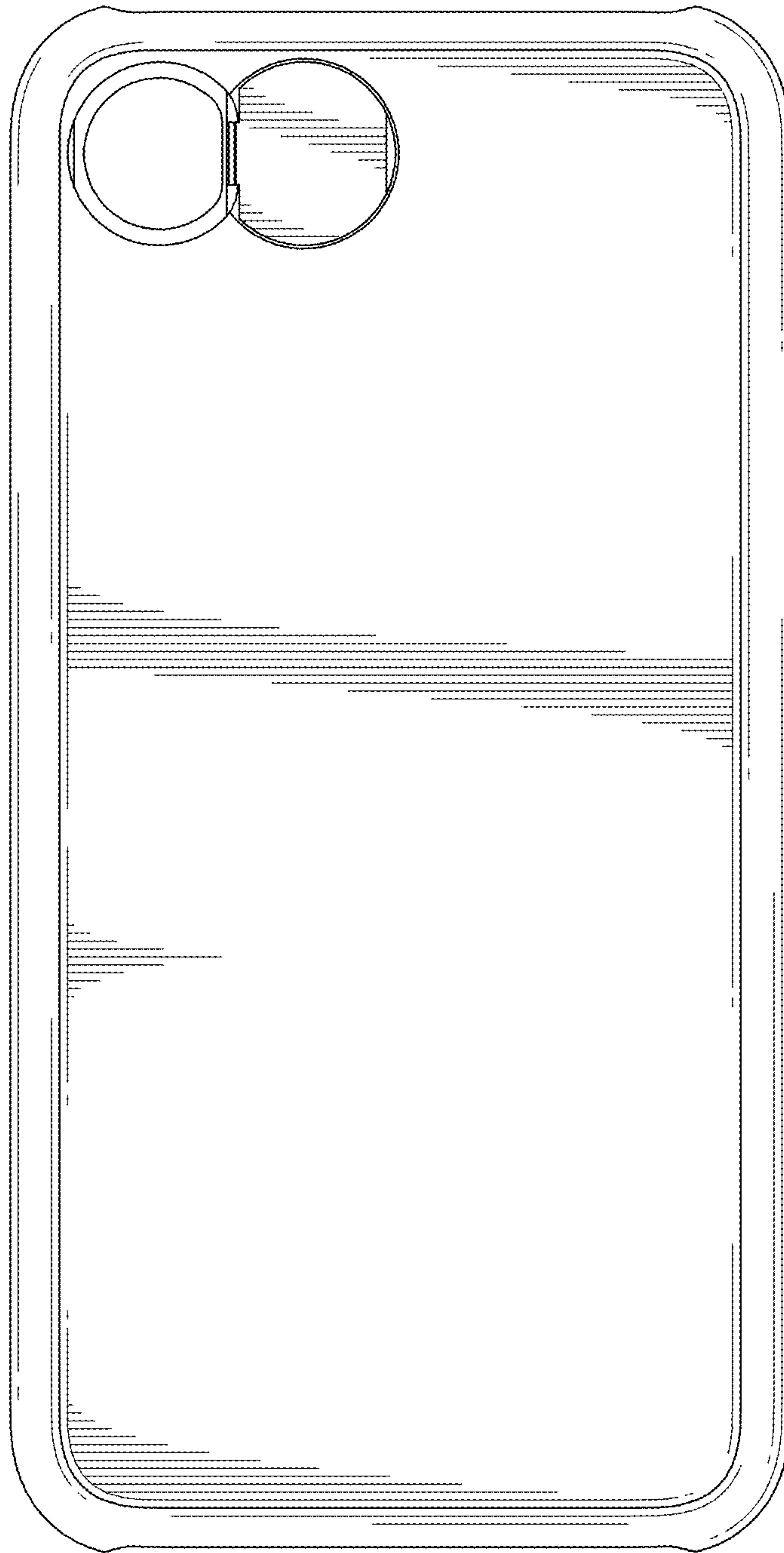

FIG.58

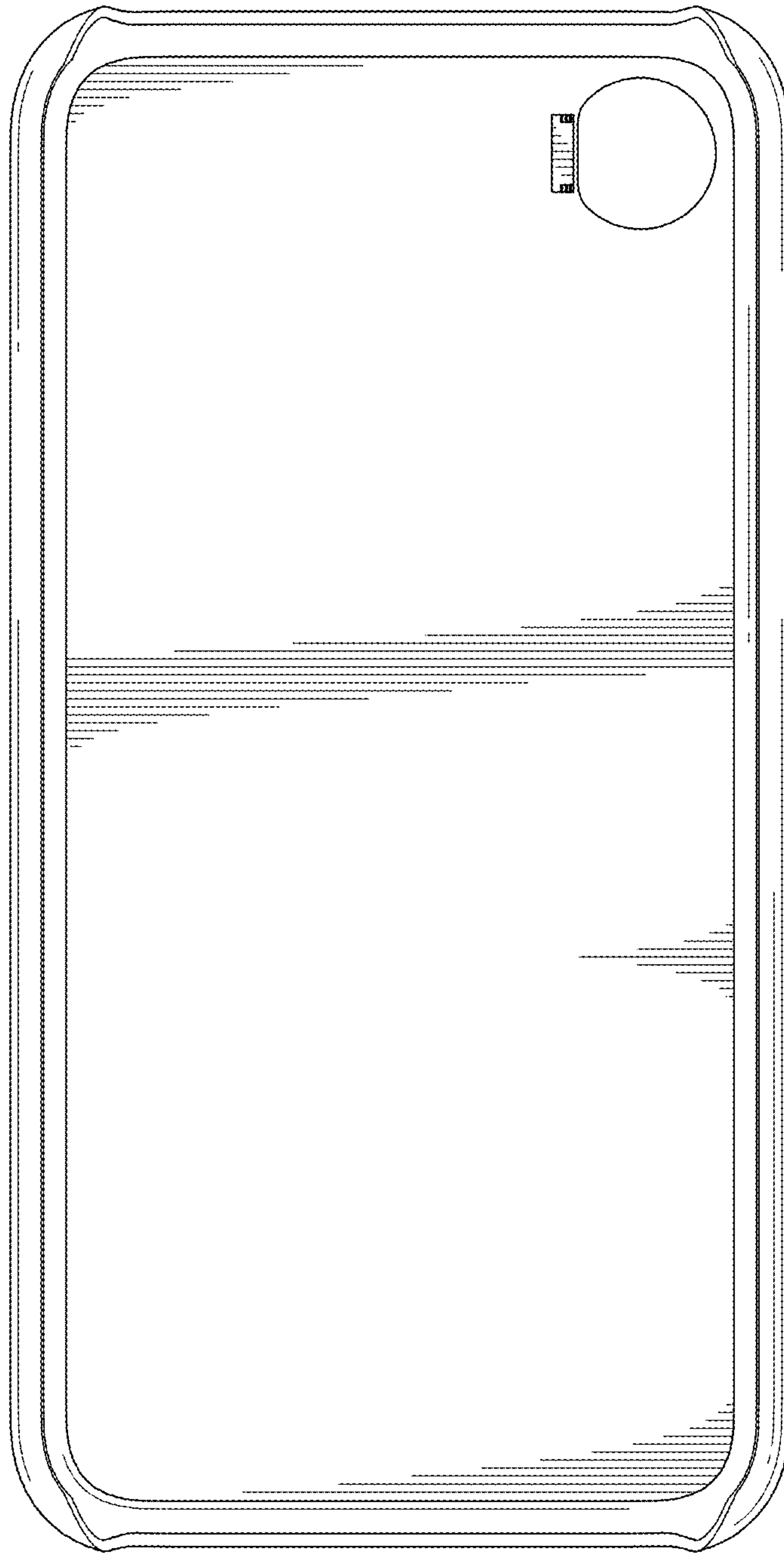

FIG.59

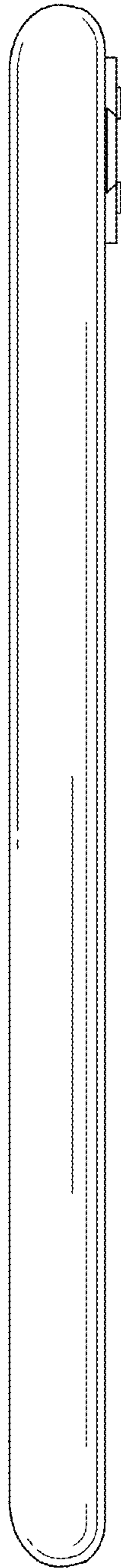

FIG.60

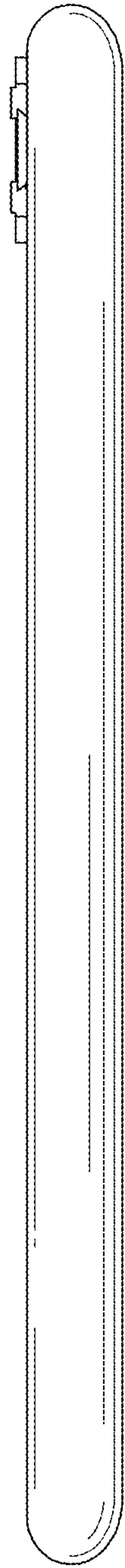

FIG.61

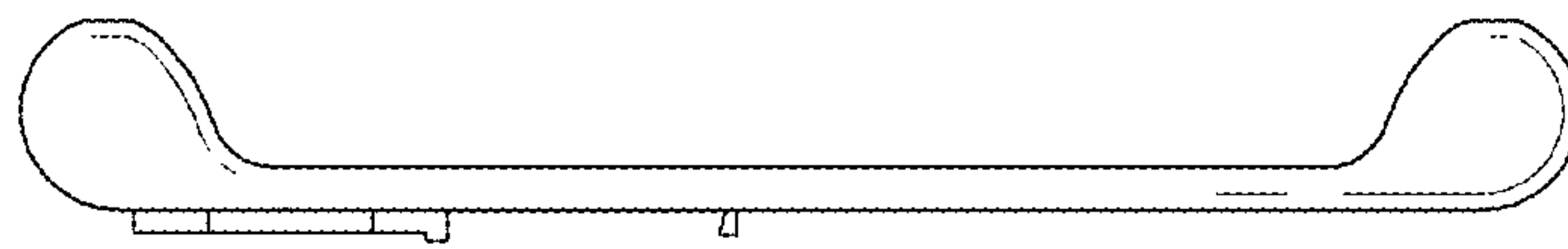

FIG.62

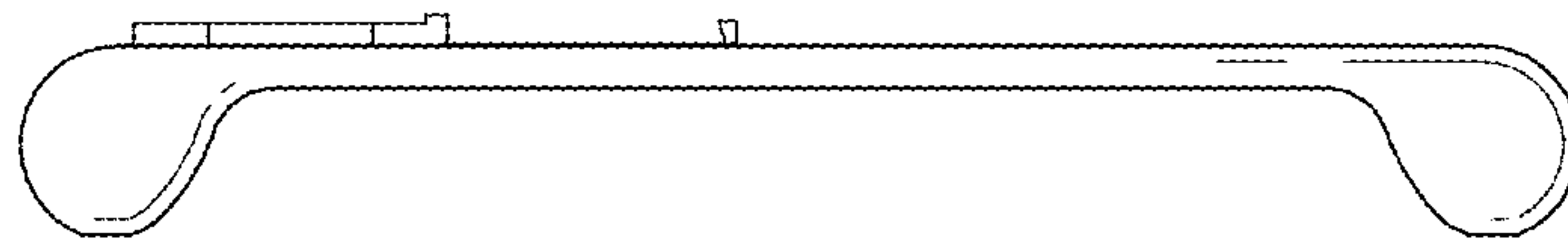

FIG.63

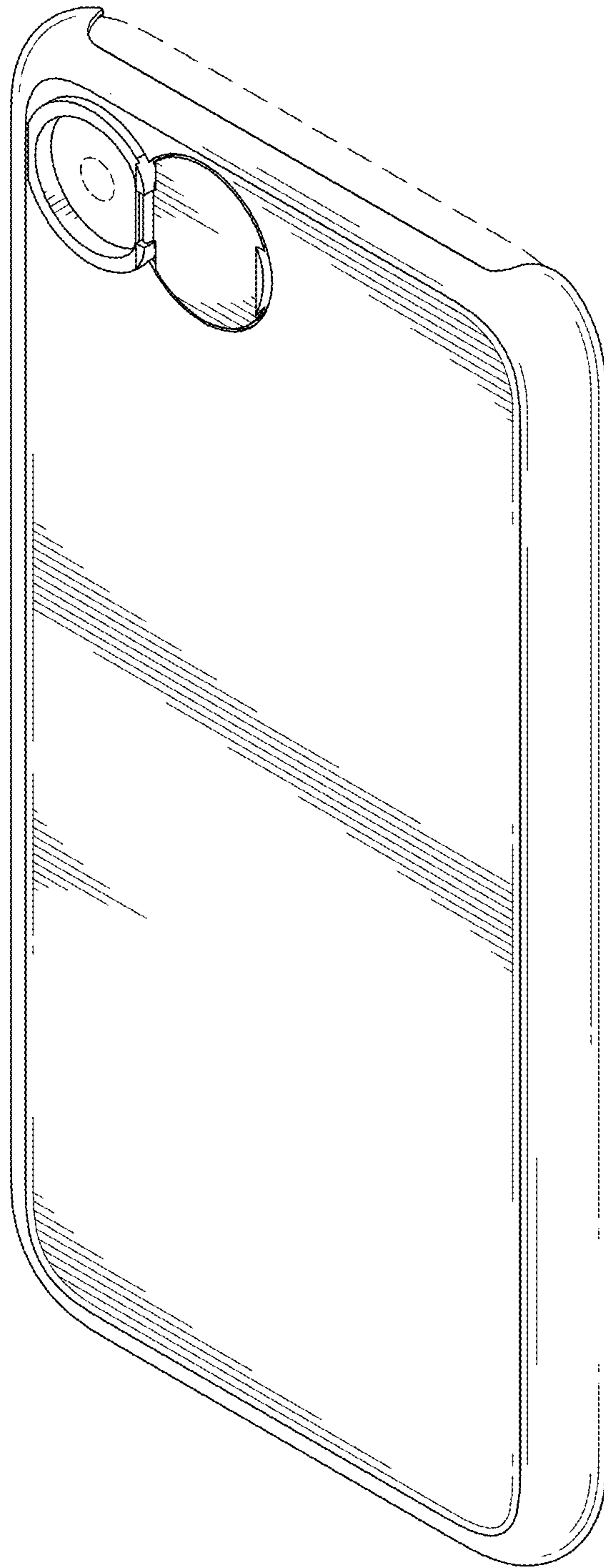

FIG.64

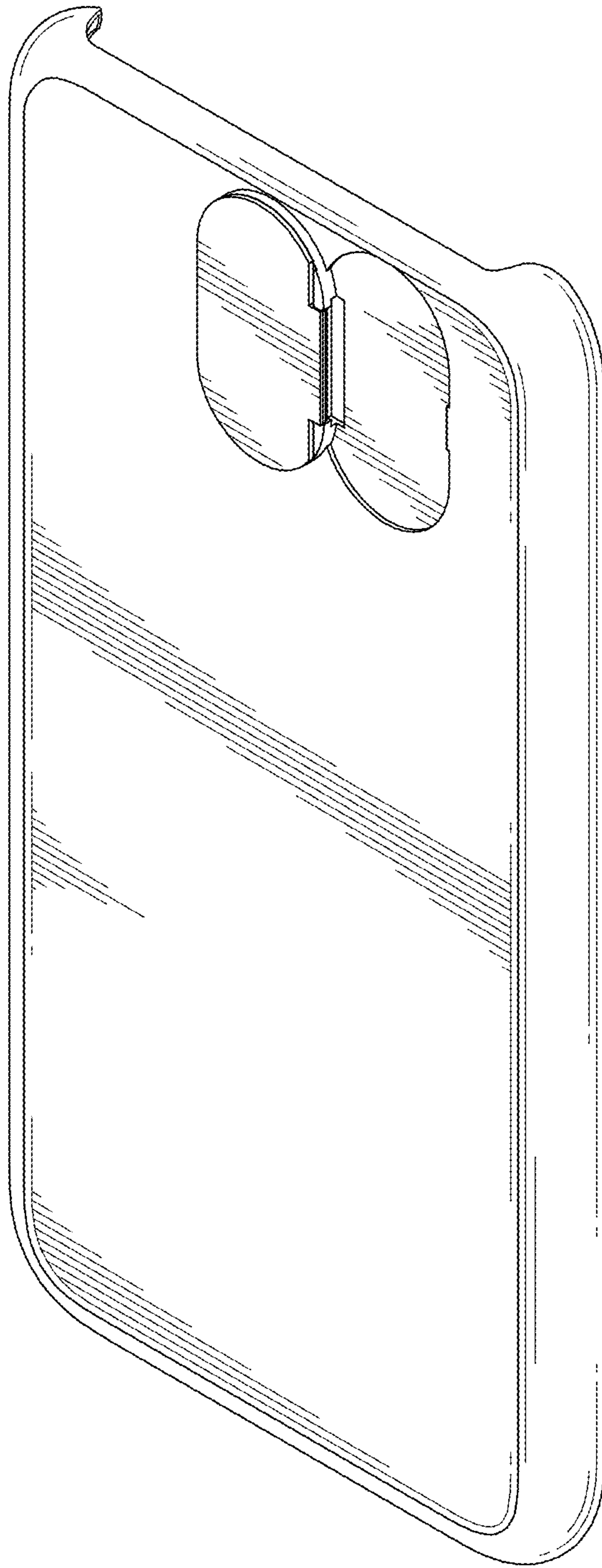

FIG.65

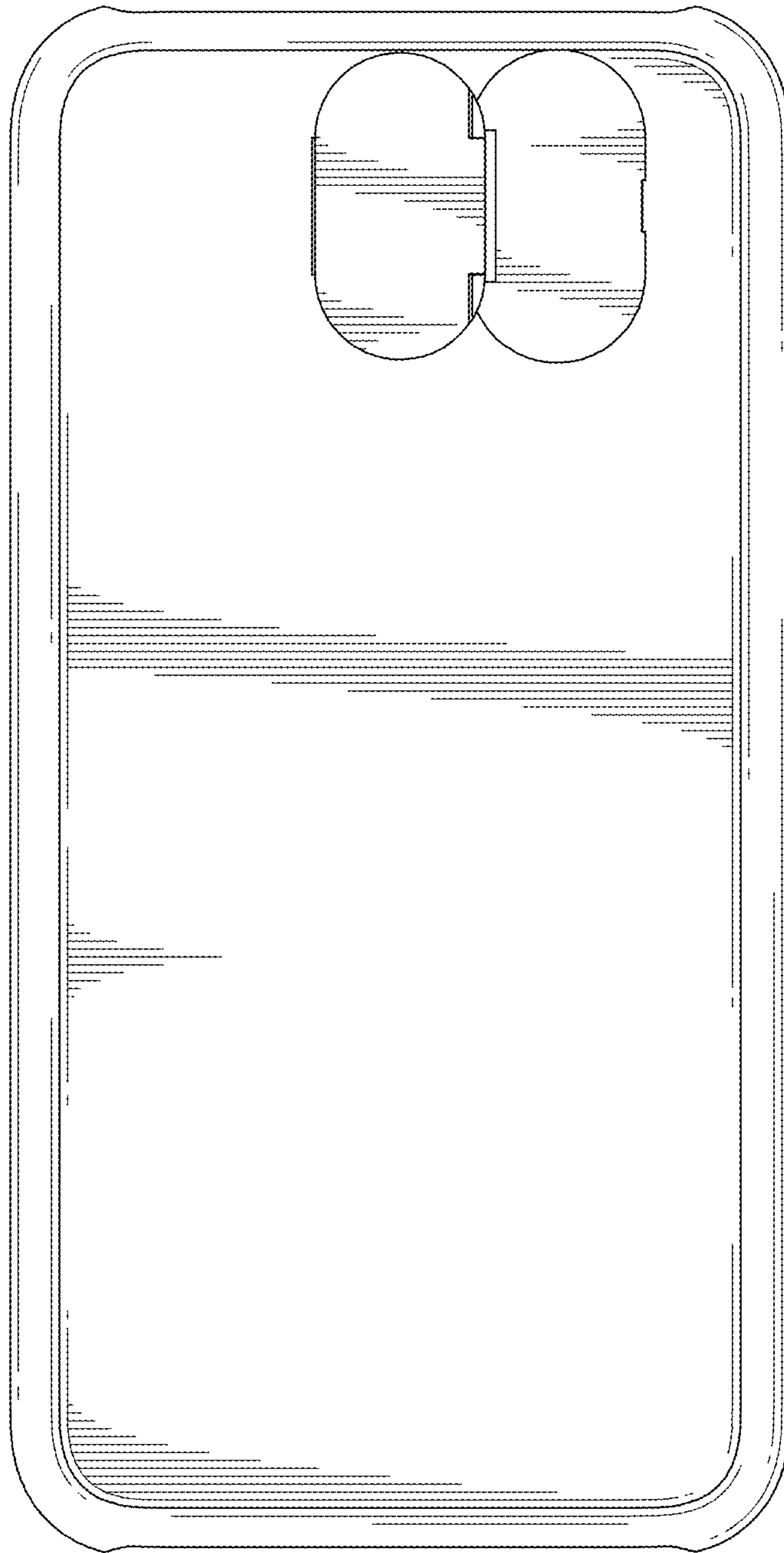

FIG.66

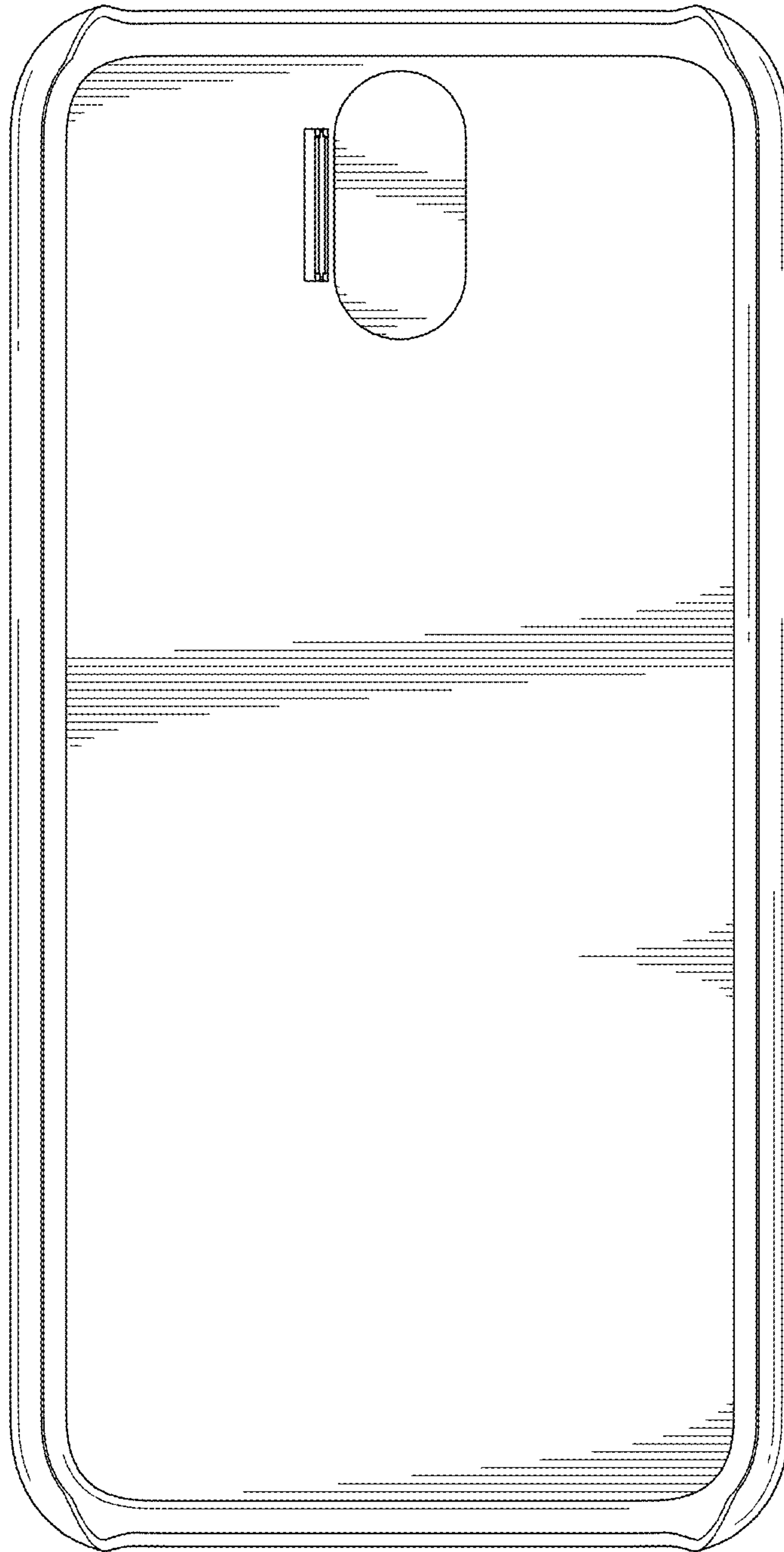

FIG.67

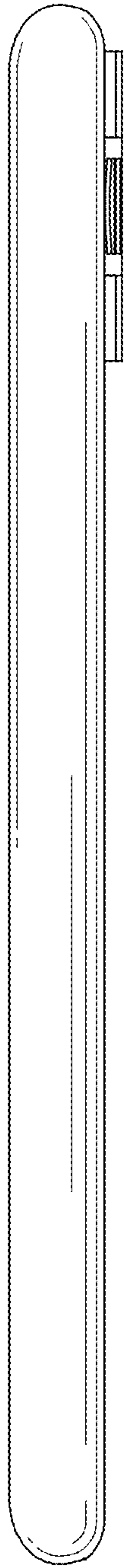

FIG.68

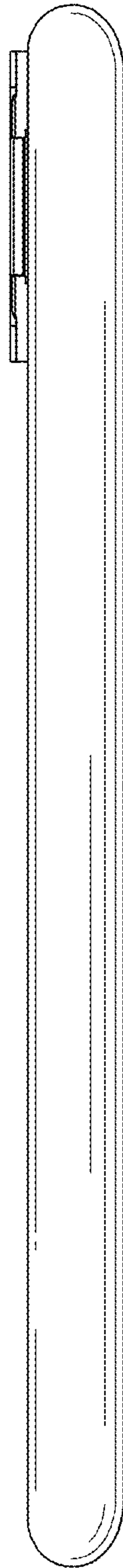

FIG.69

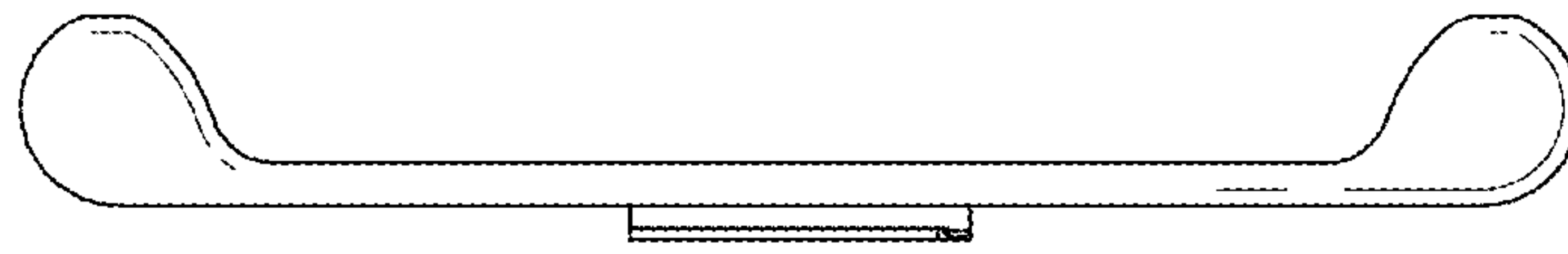

FIG.70

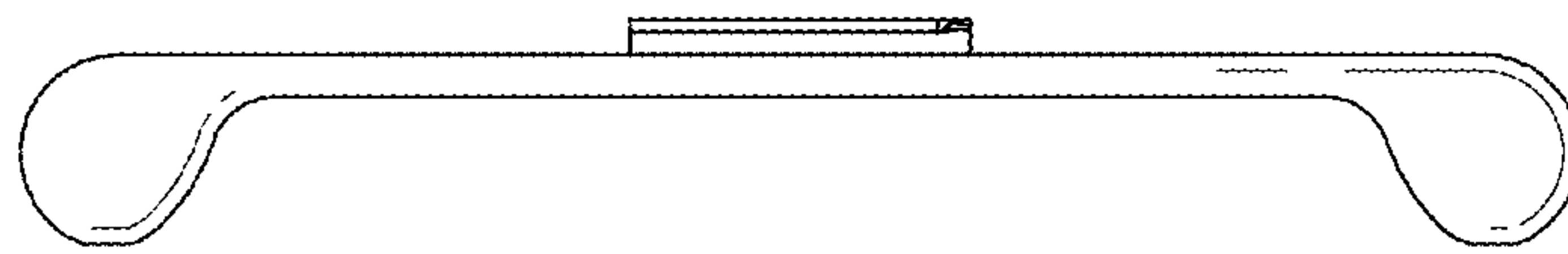

FIG.71

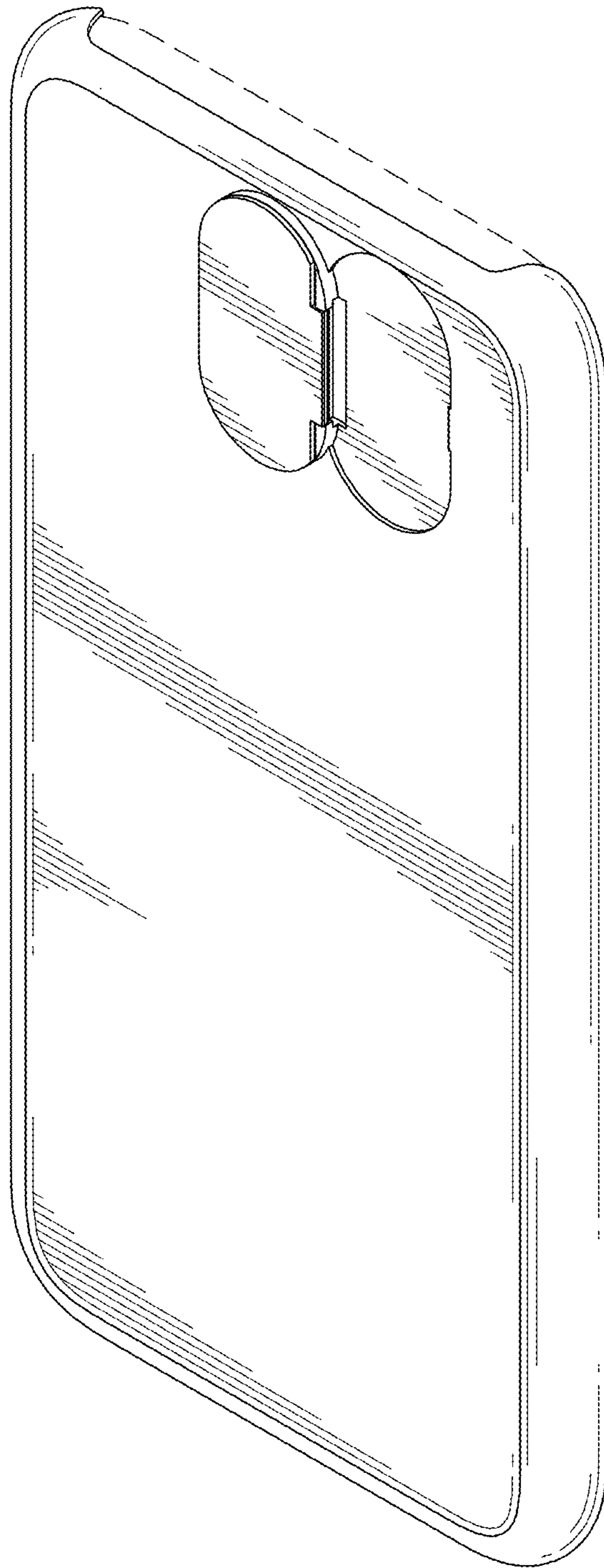

FIG.72

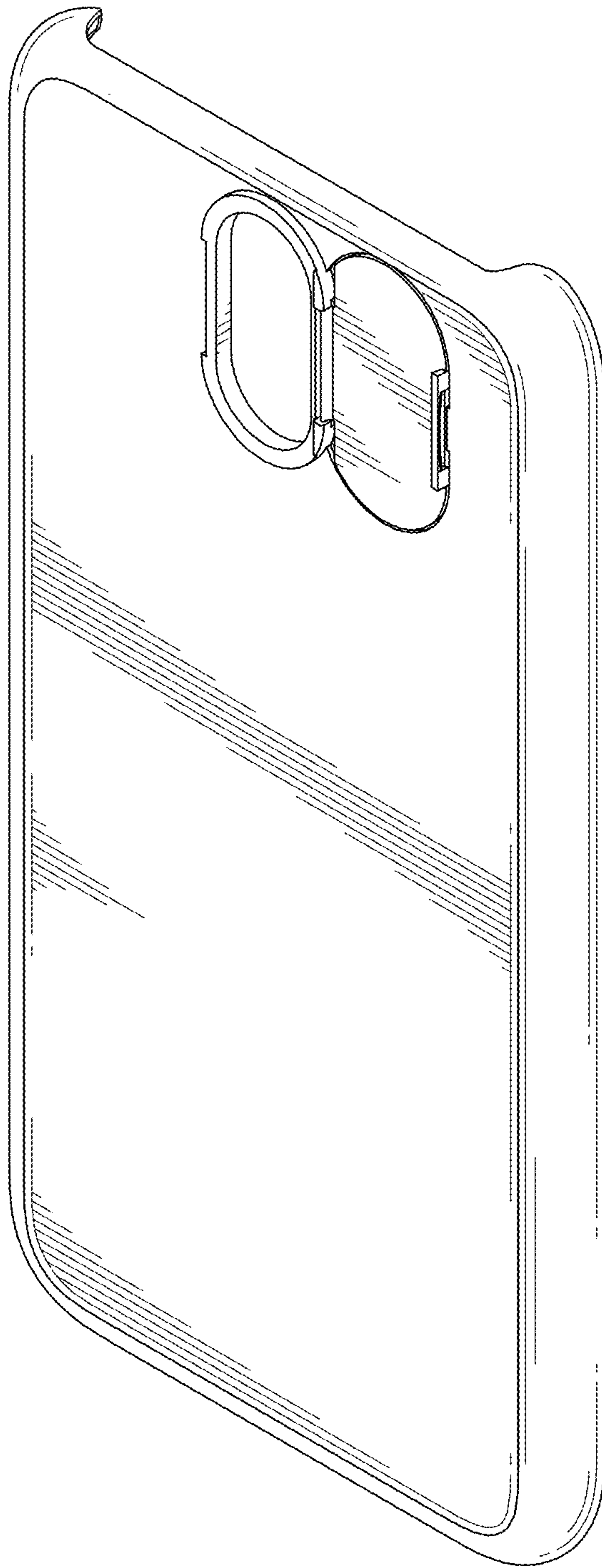

FIG.73

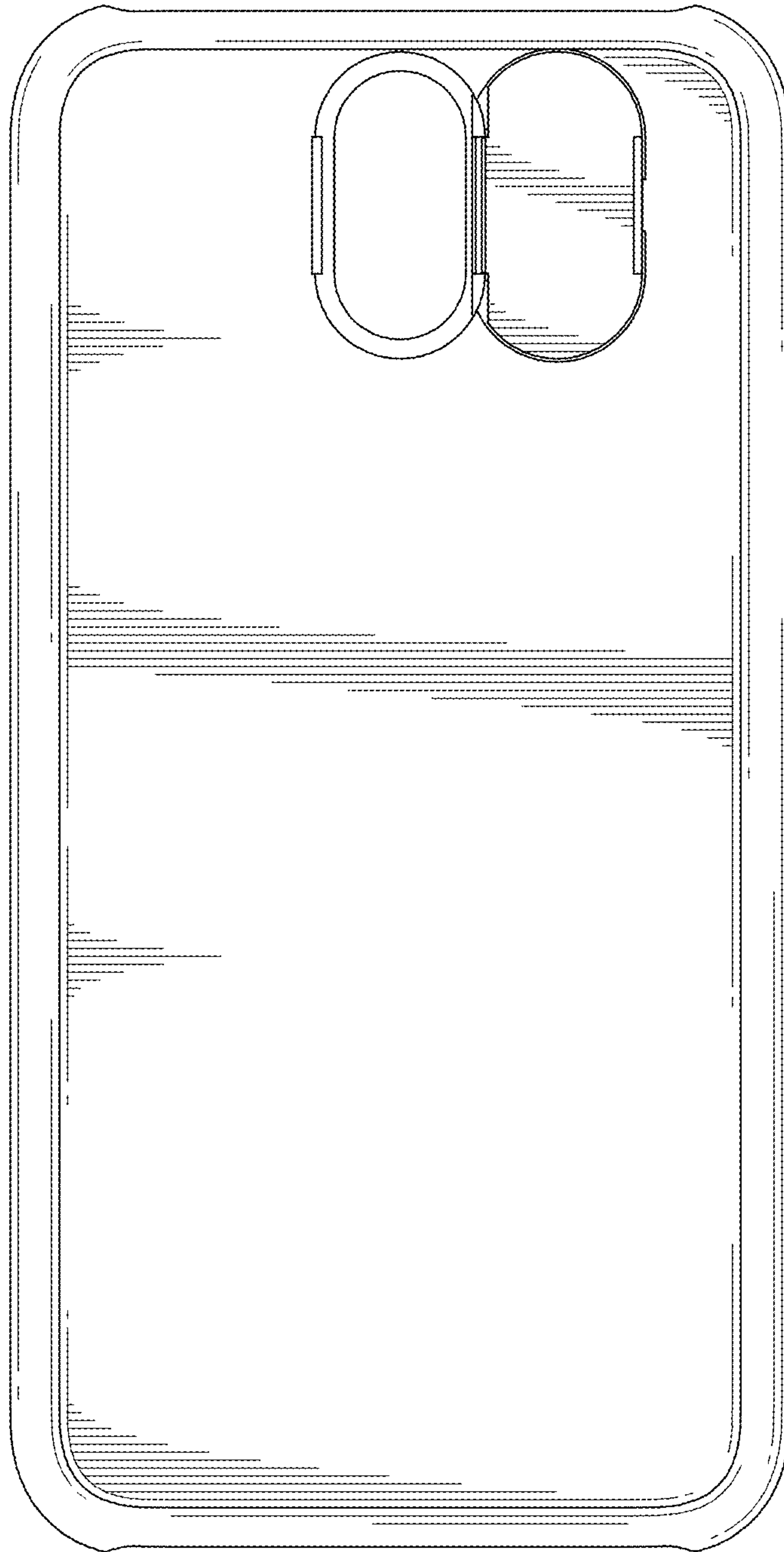

FIG.74

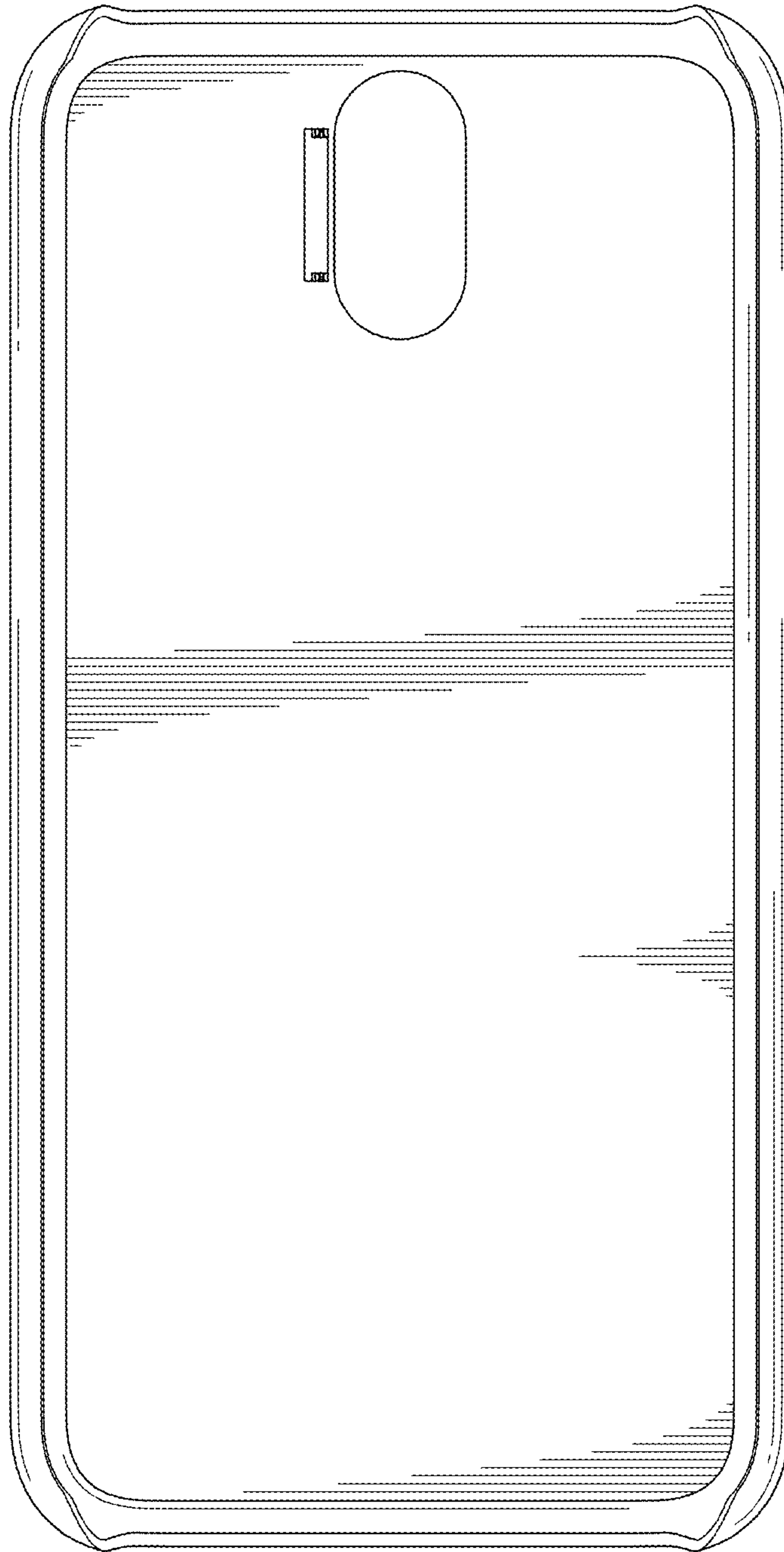

FIG. 75

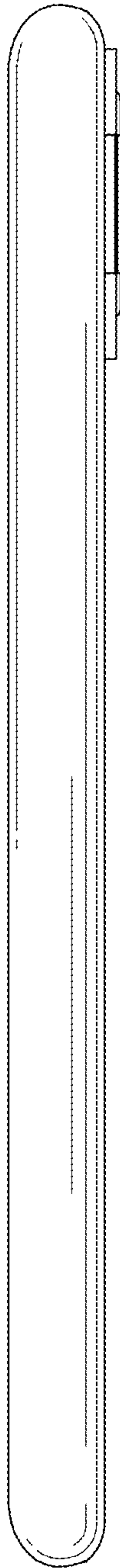

FIG.76

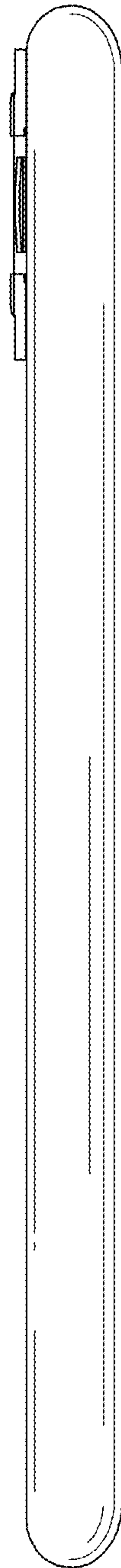

FIG.77

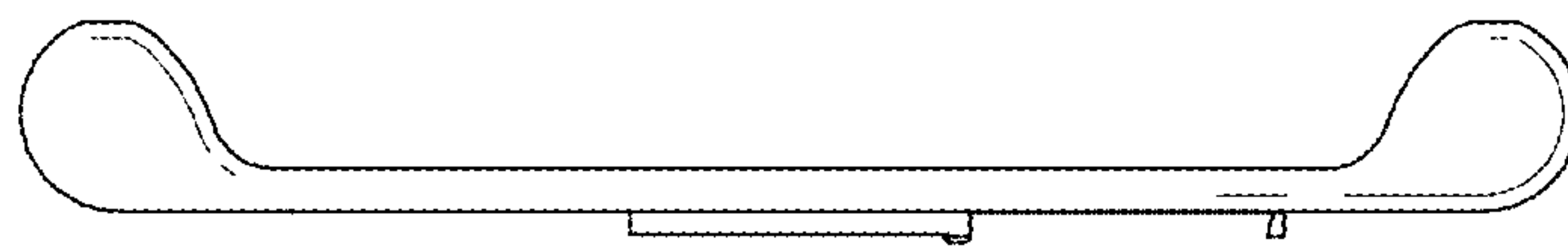

FIG.78

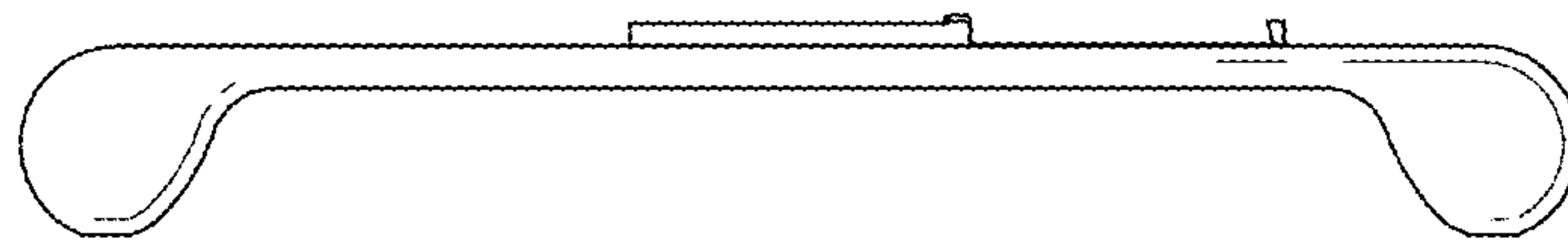

FIG.79

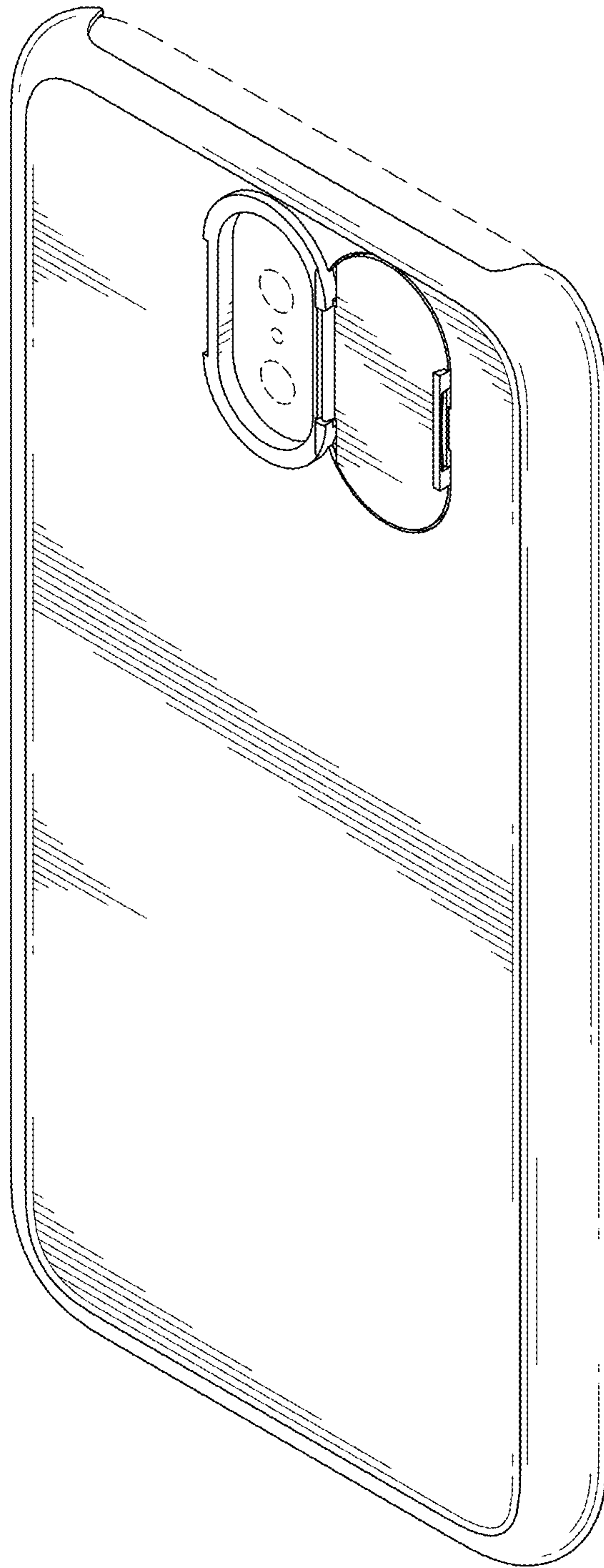

FIG.80

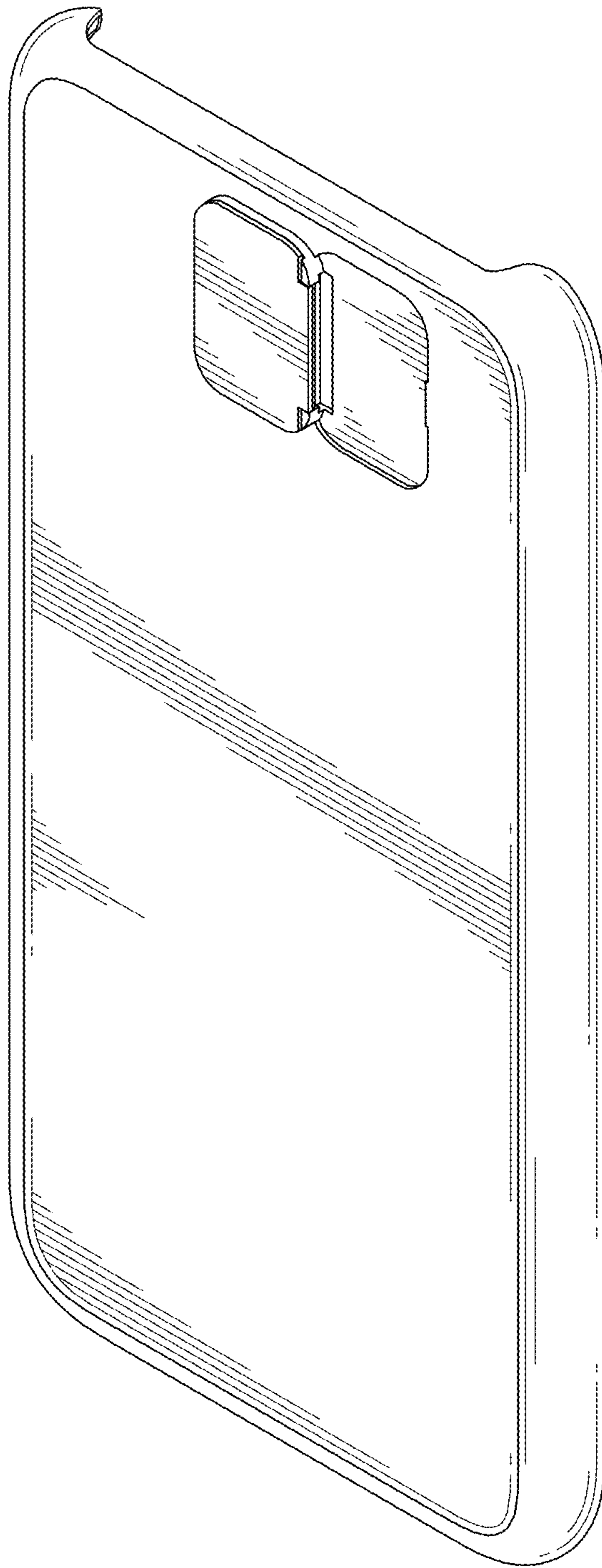

FIG.81

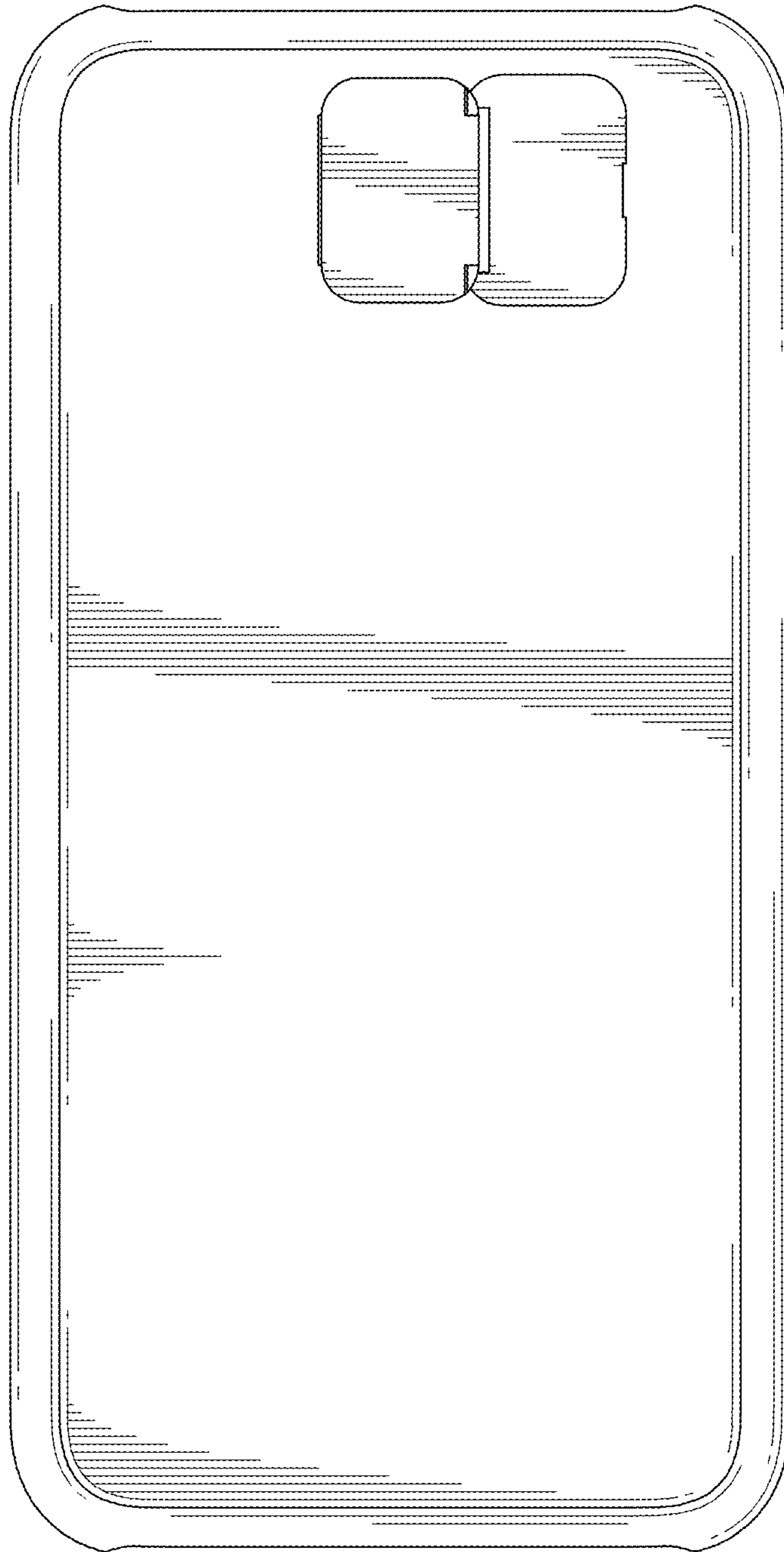

FIG.82

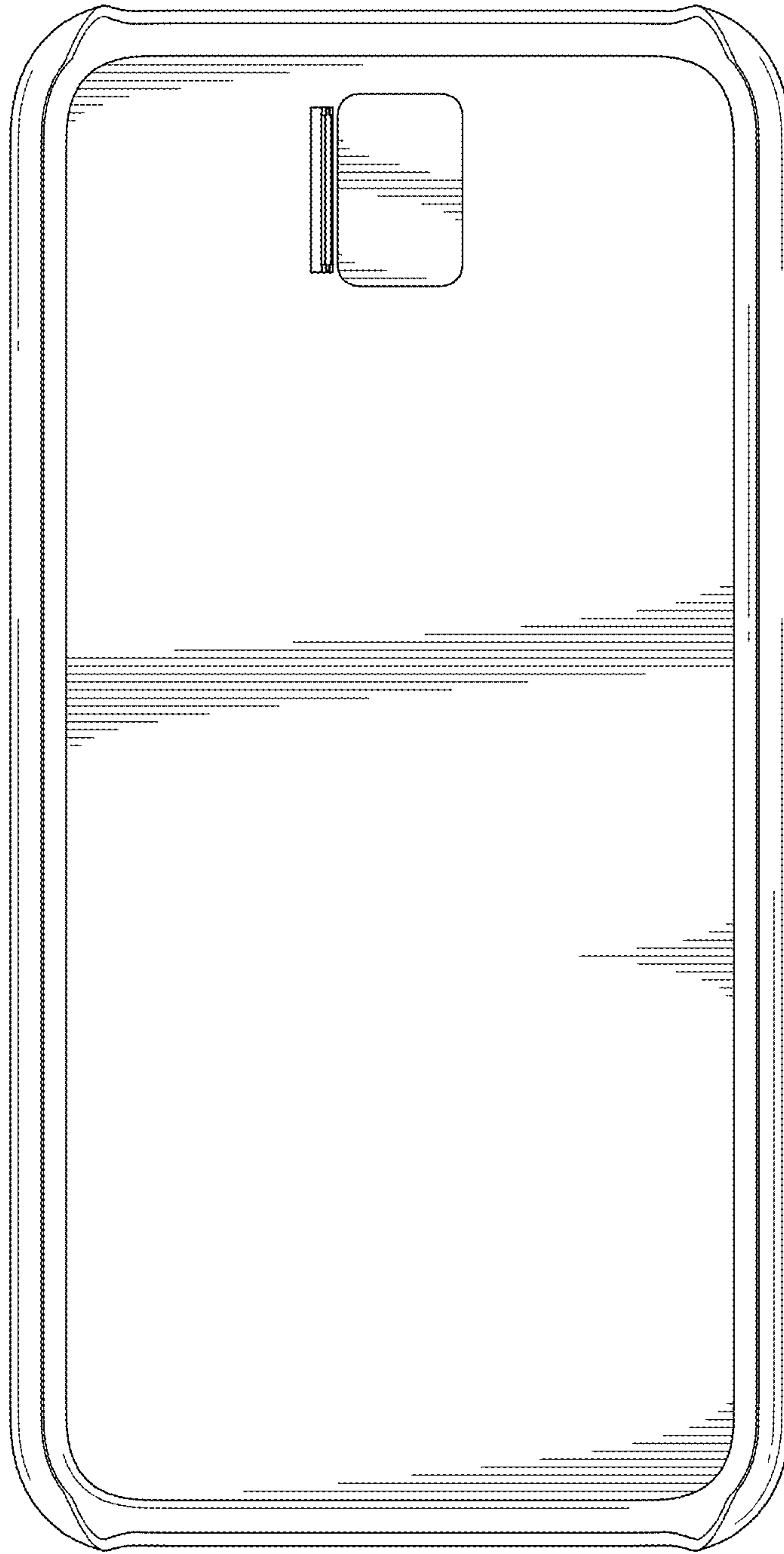

FIG.83

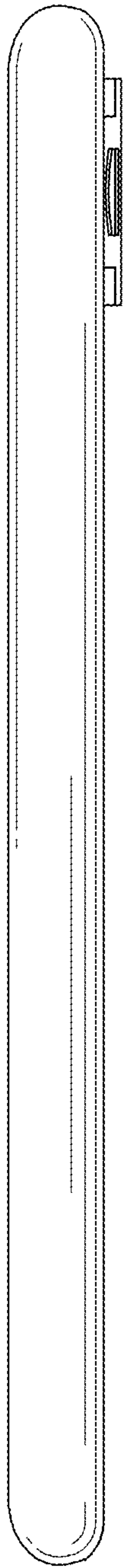

FIG.84

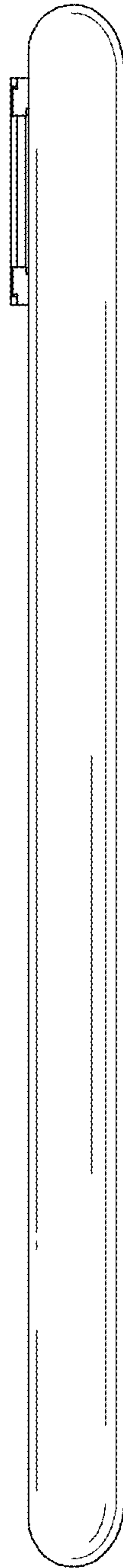

FIG.85

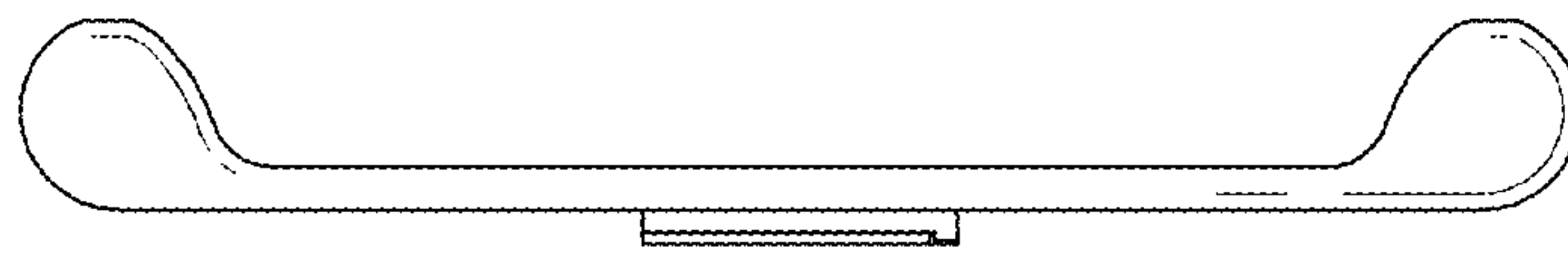

FIG.86

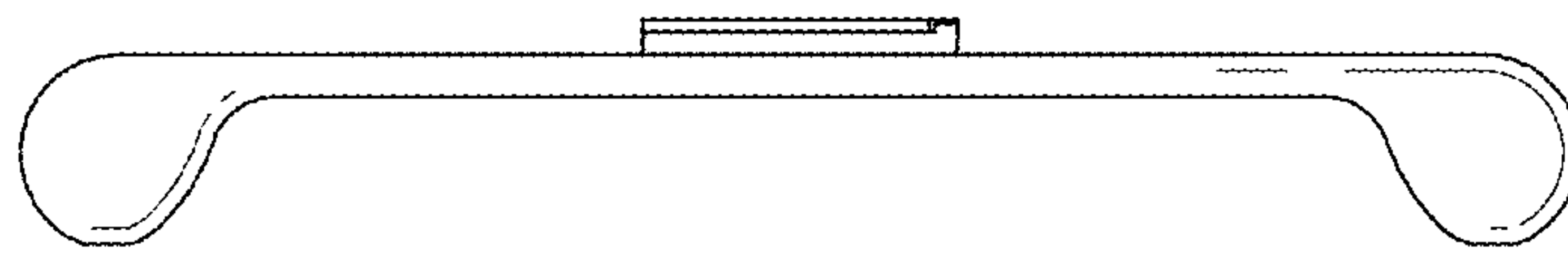

FIG.87

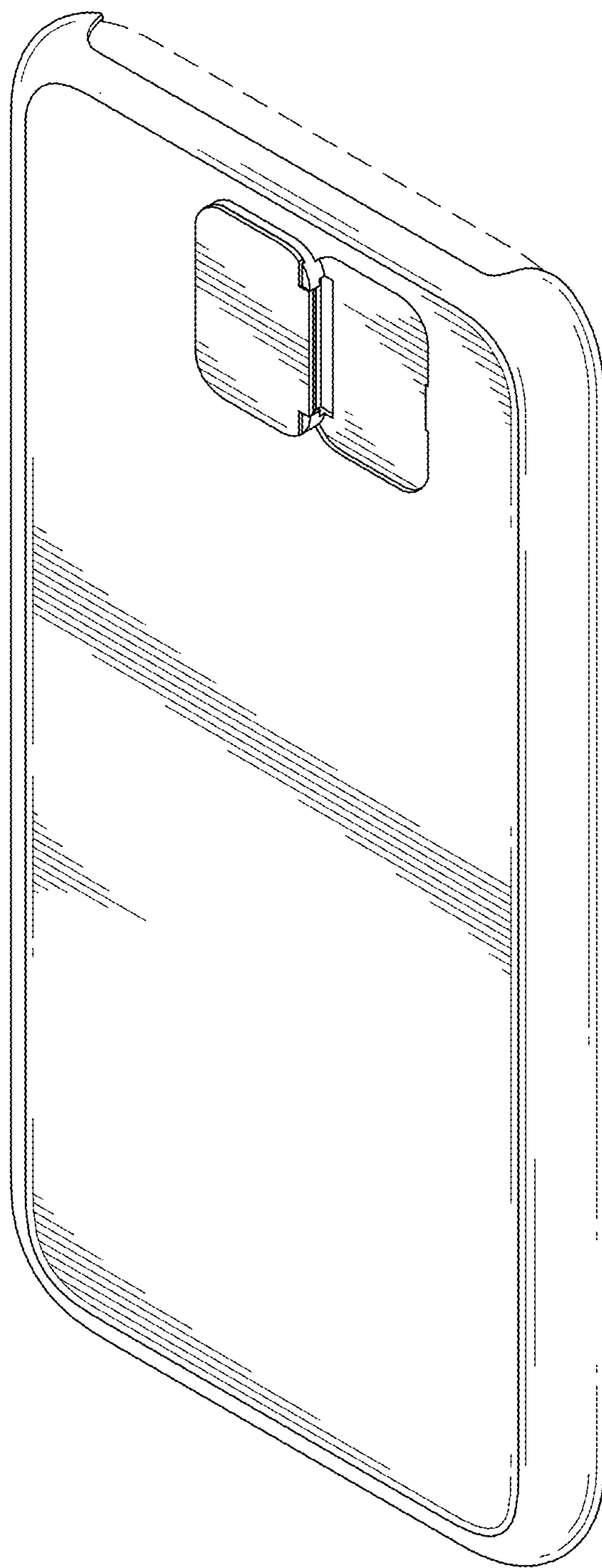

FIG.88

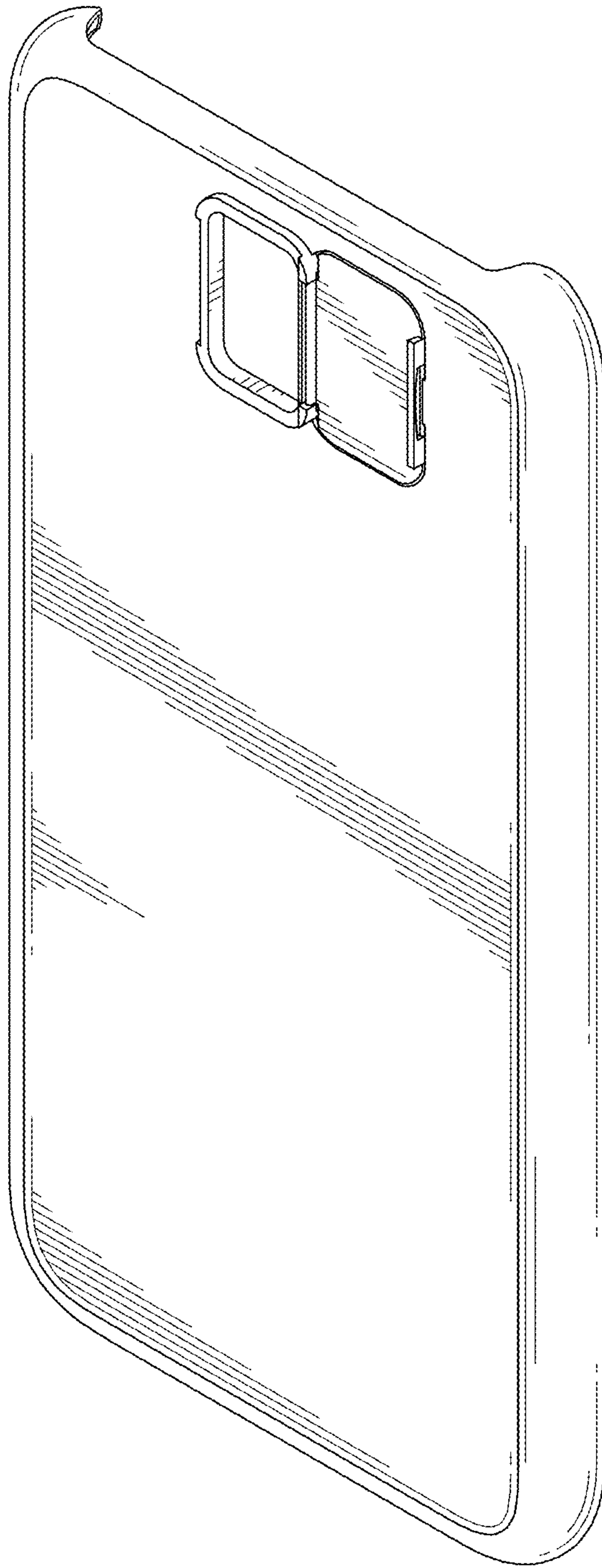

FIG.89

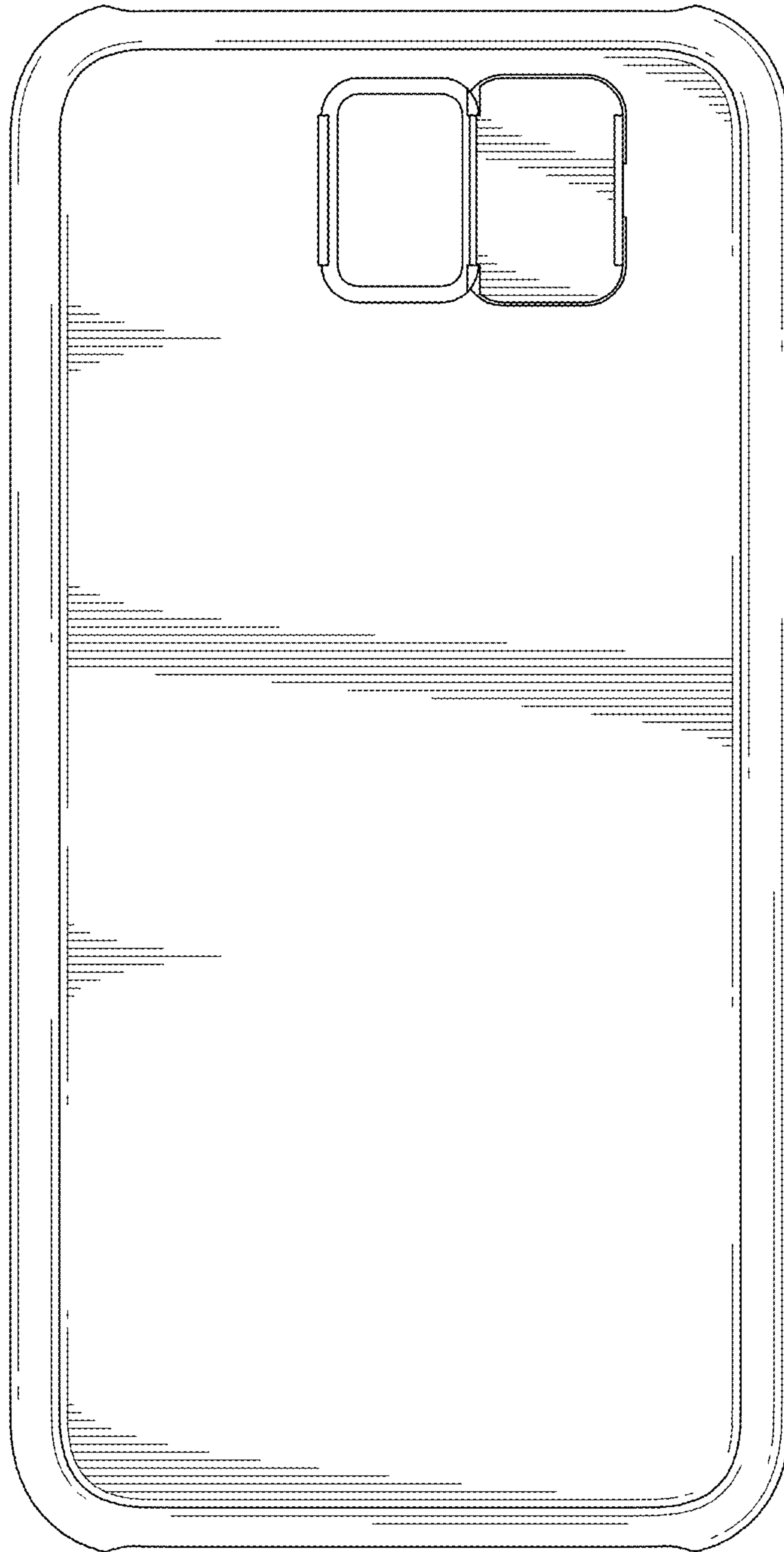

FIG.90

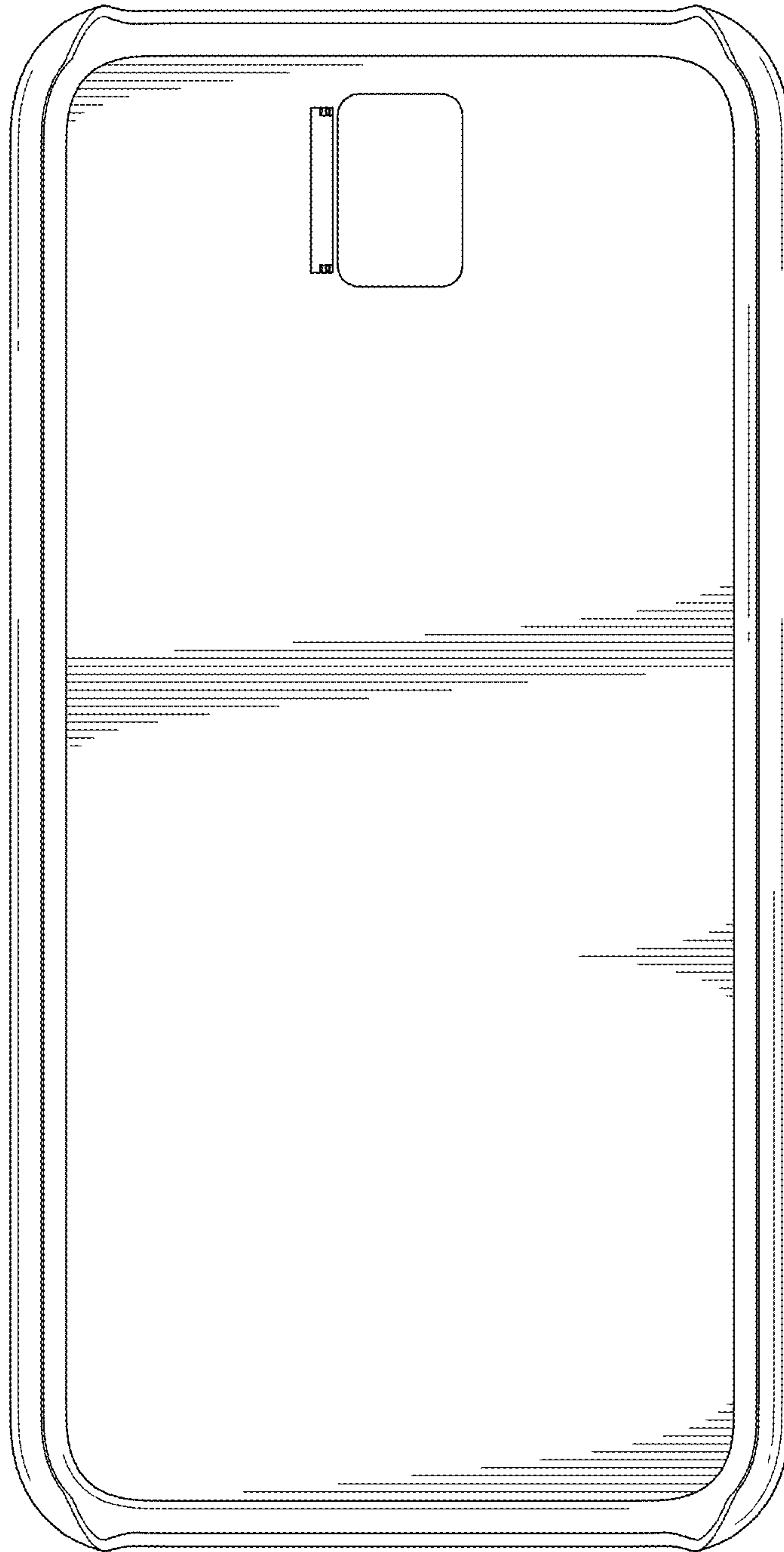

FIG.91

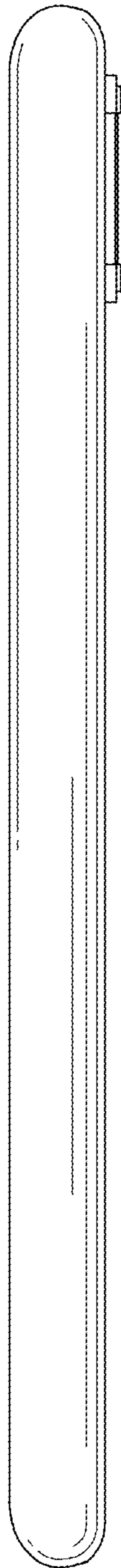

FIG.92

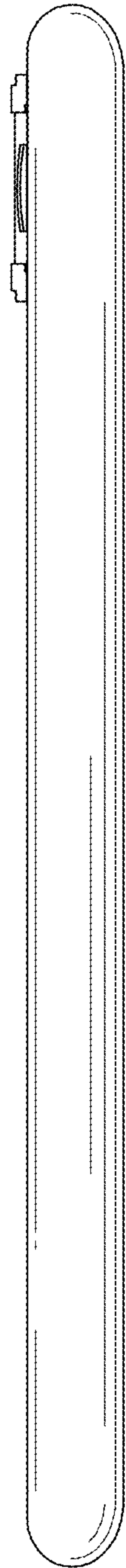

FIG.93

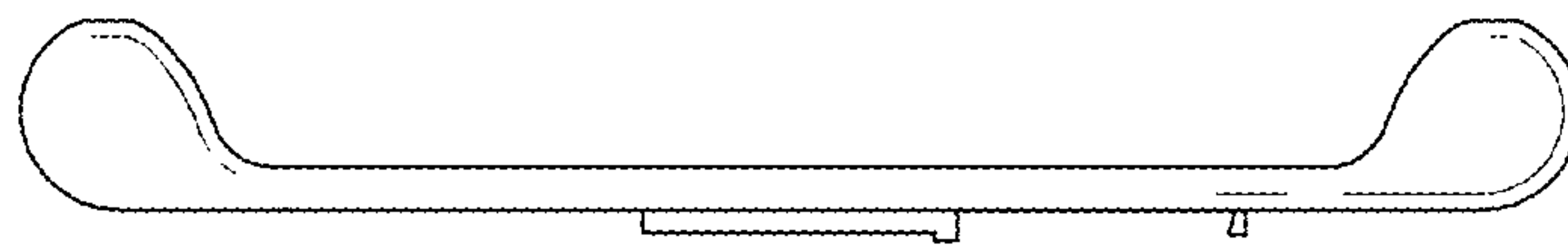

FIG.94

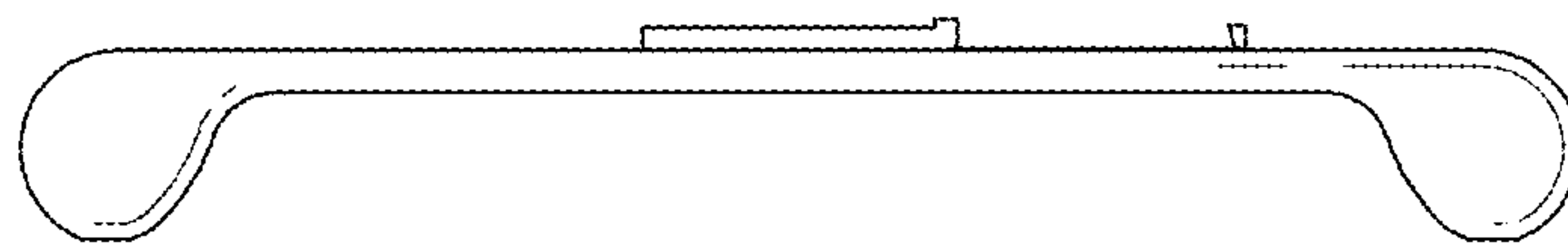

FIG.95

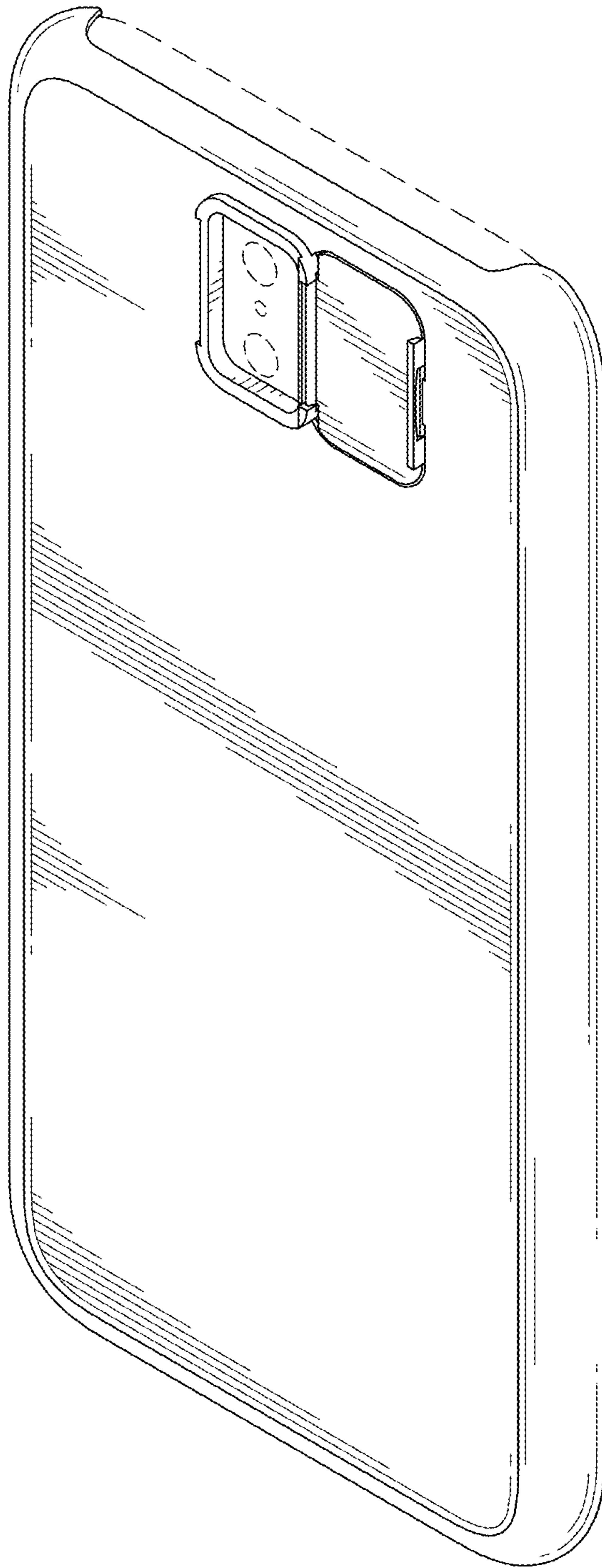

FIG.96

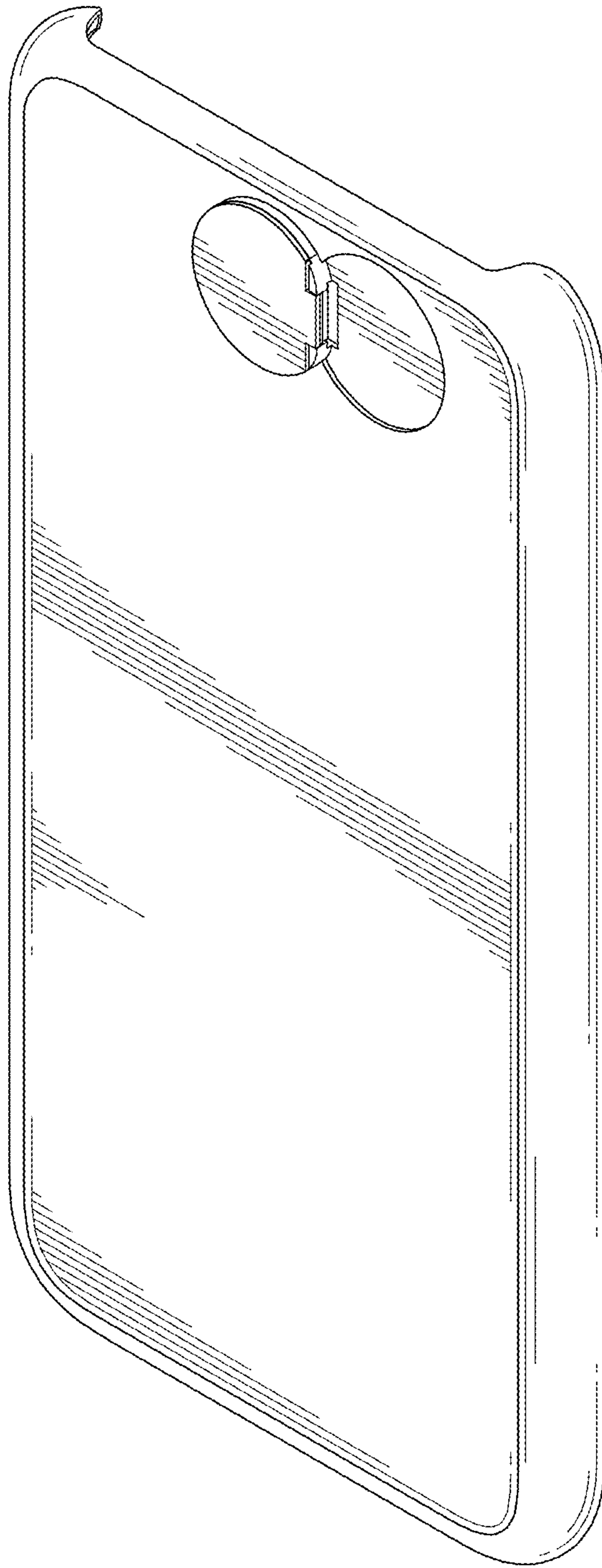

FIG.97

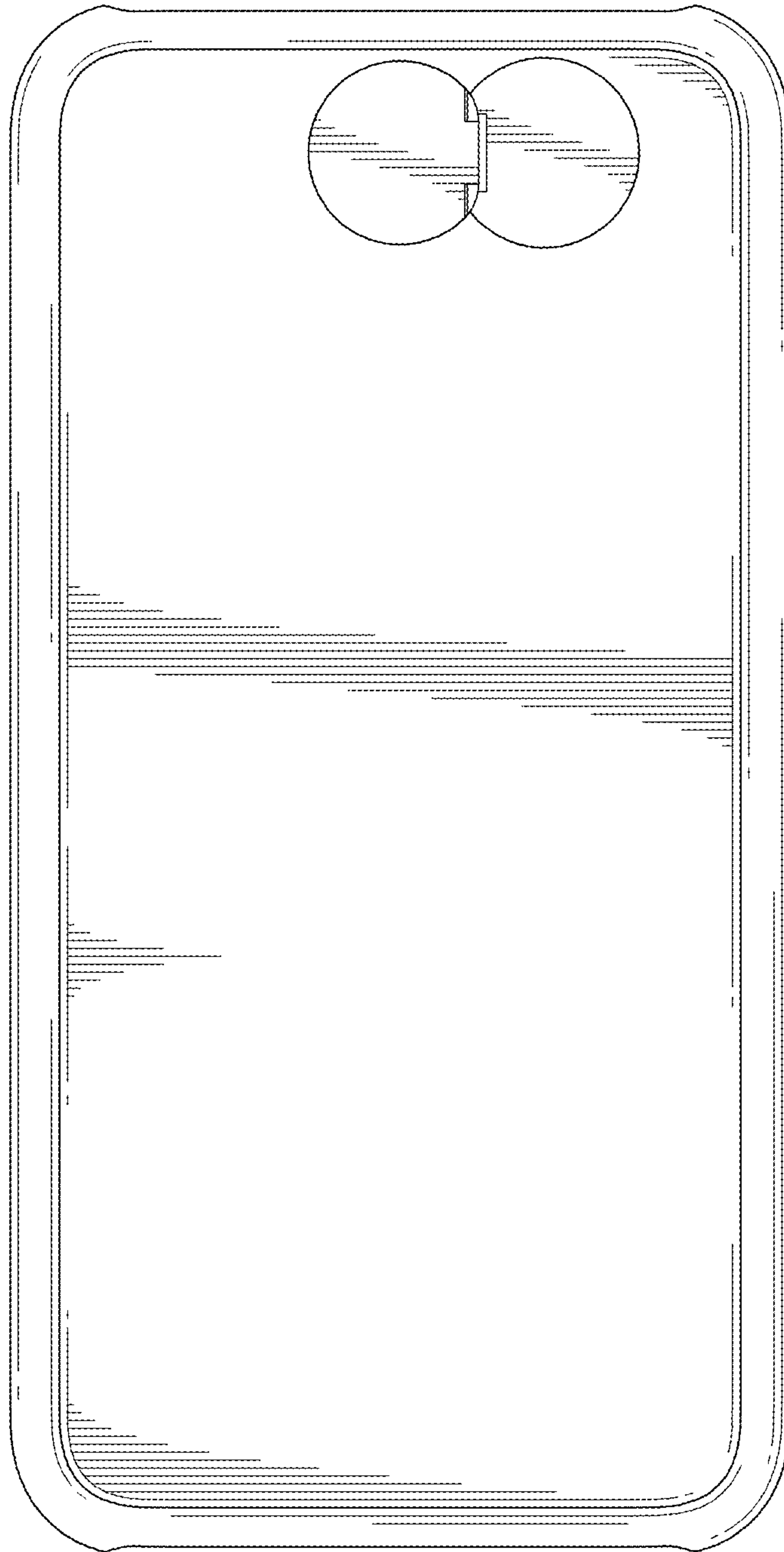

FIG.98

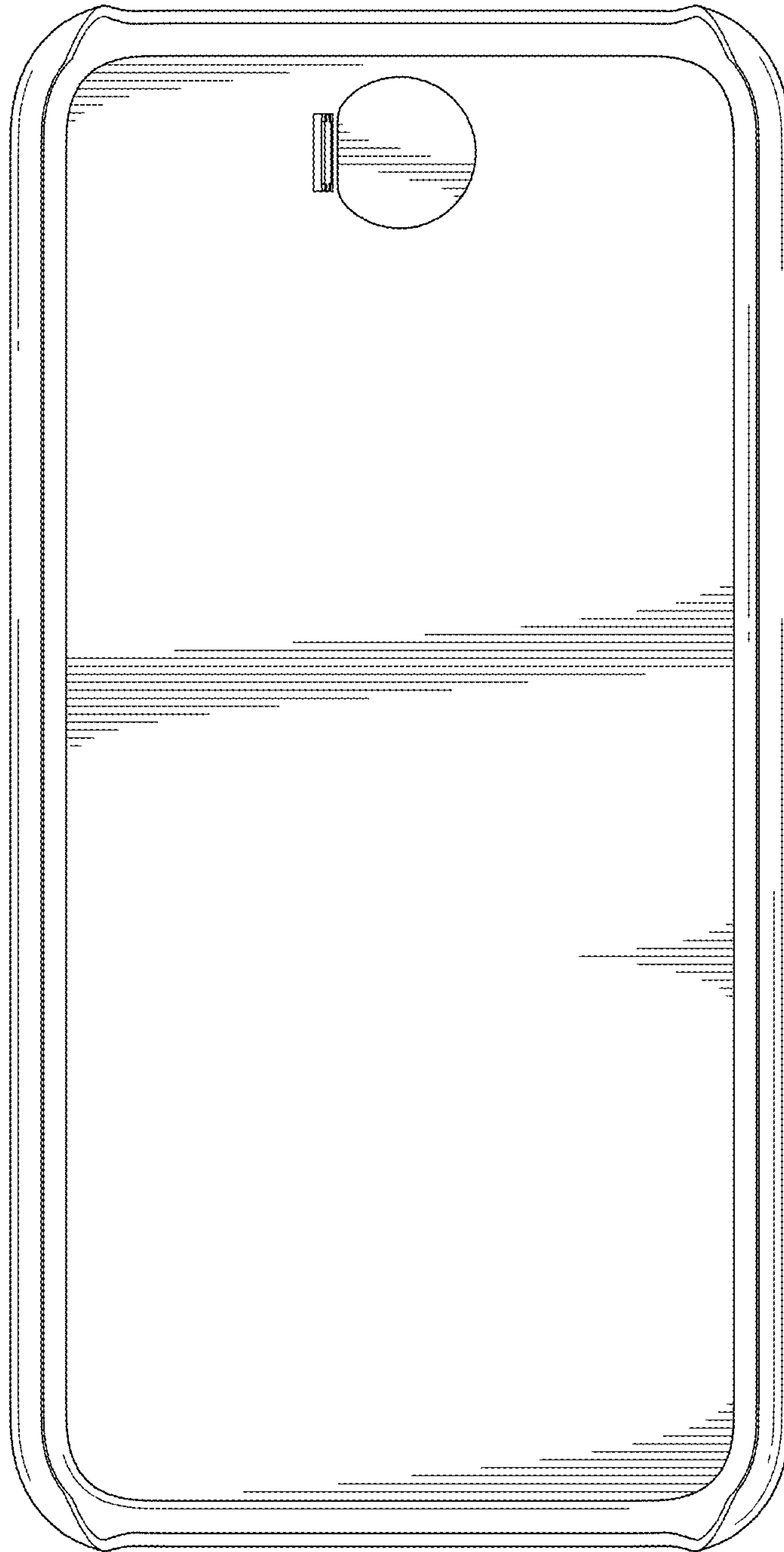

FIG.99

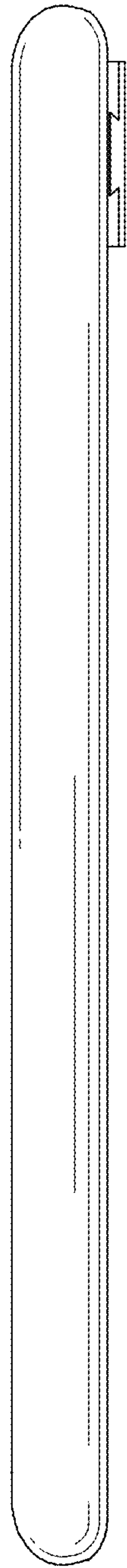

FIG. 100

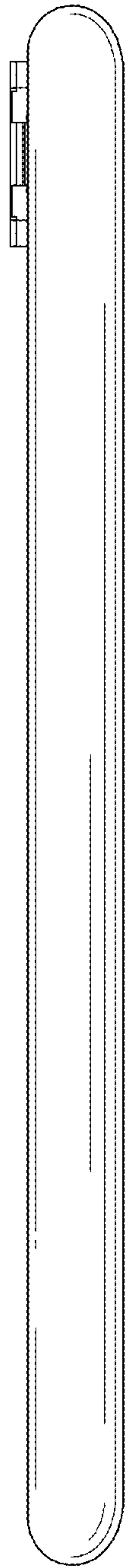

FIG. 101

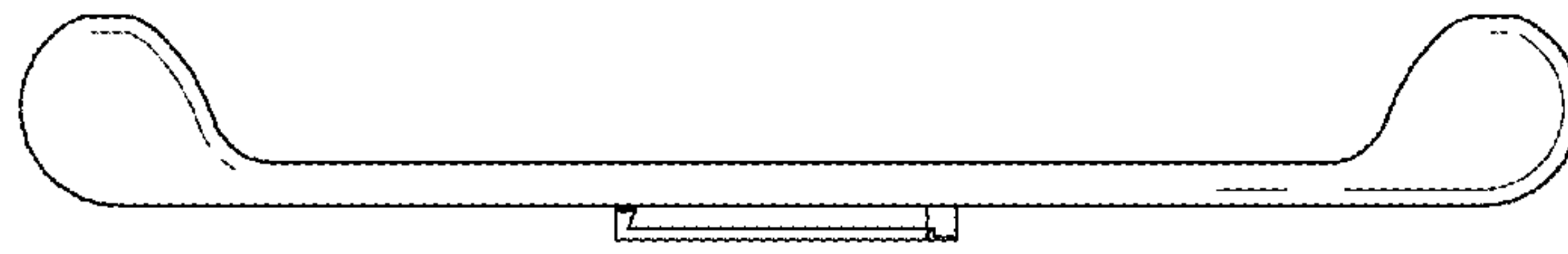

FIG.102

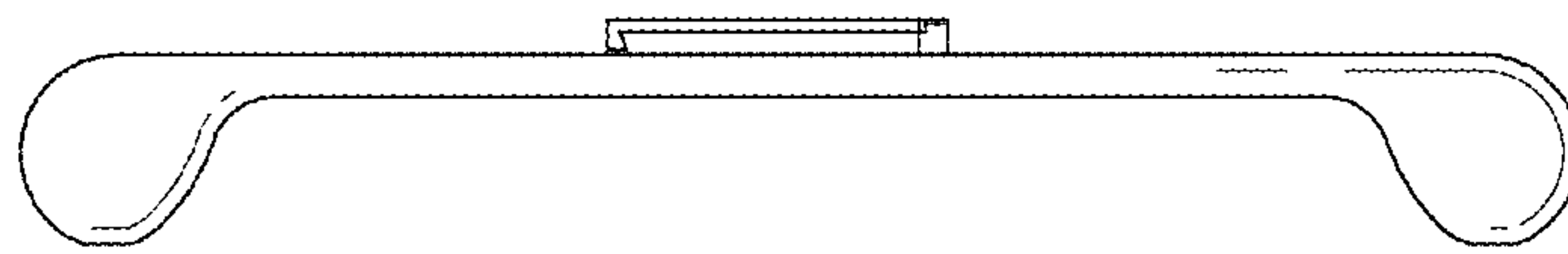

FIG.103

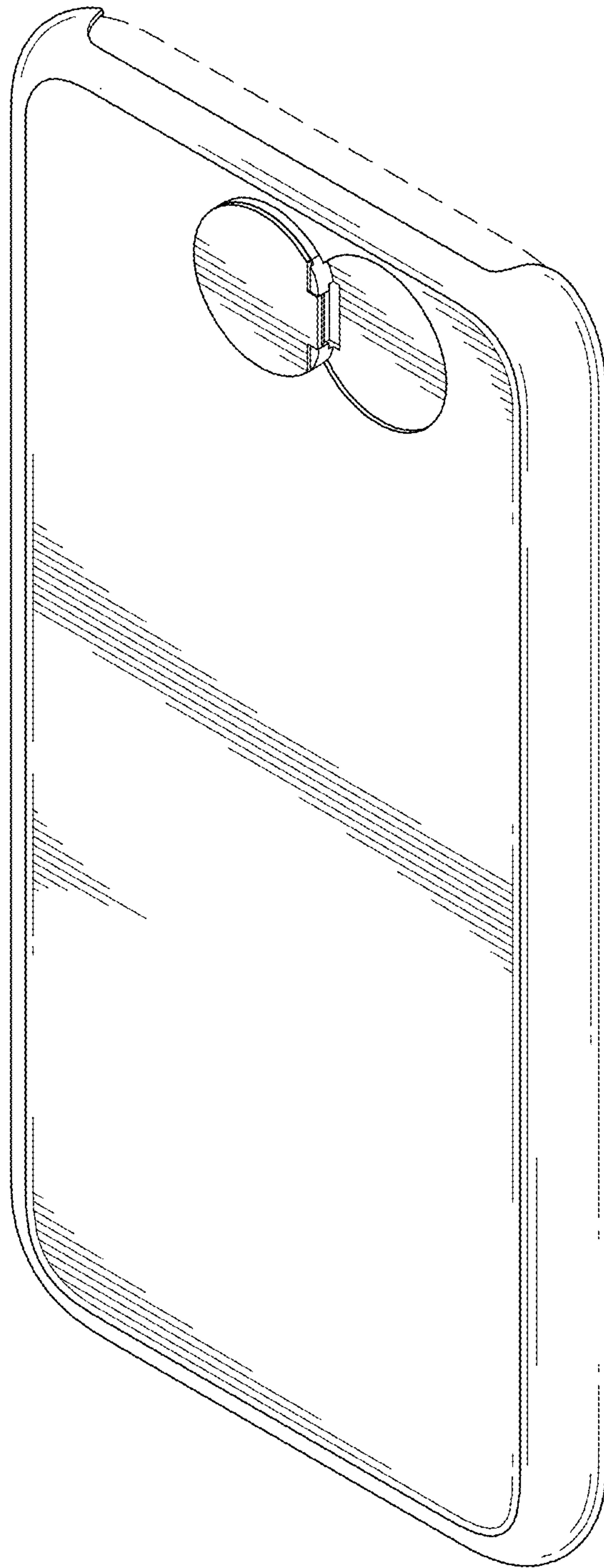

FIG.104

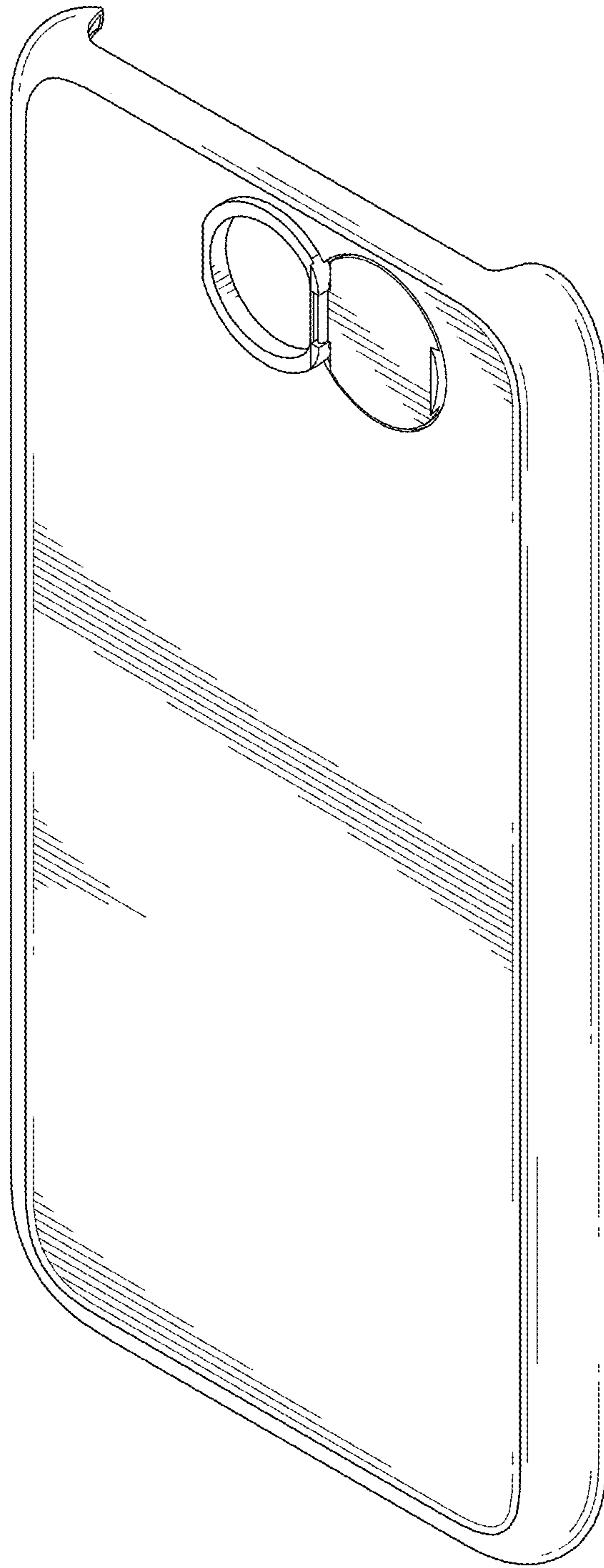

FIG. 105

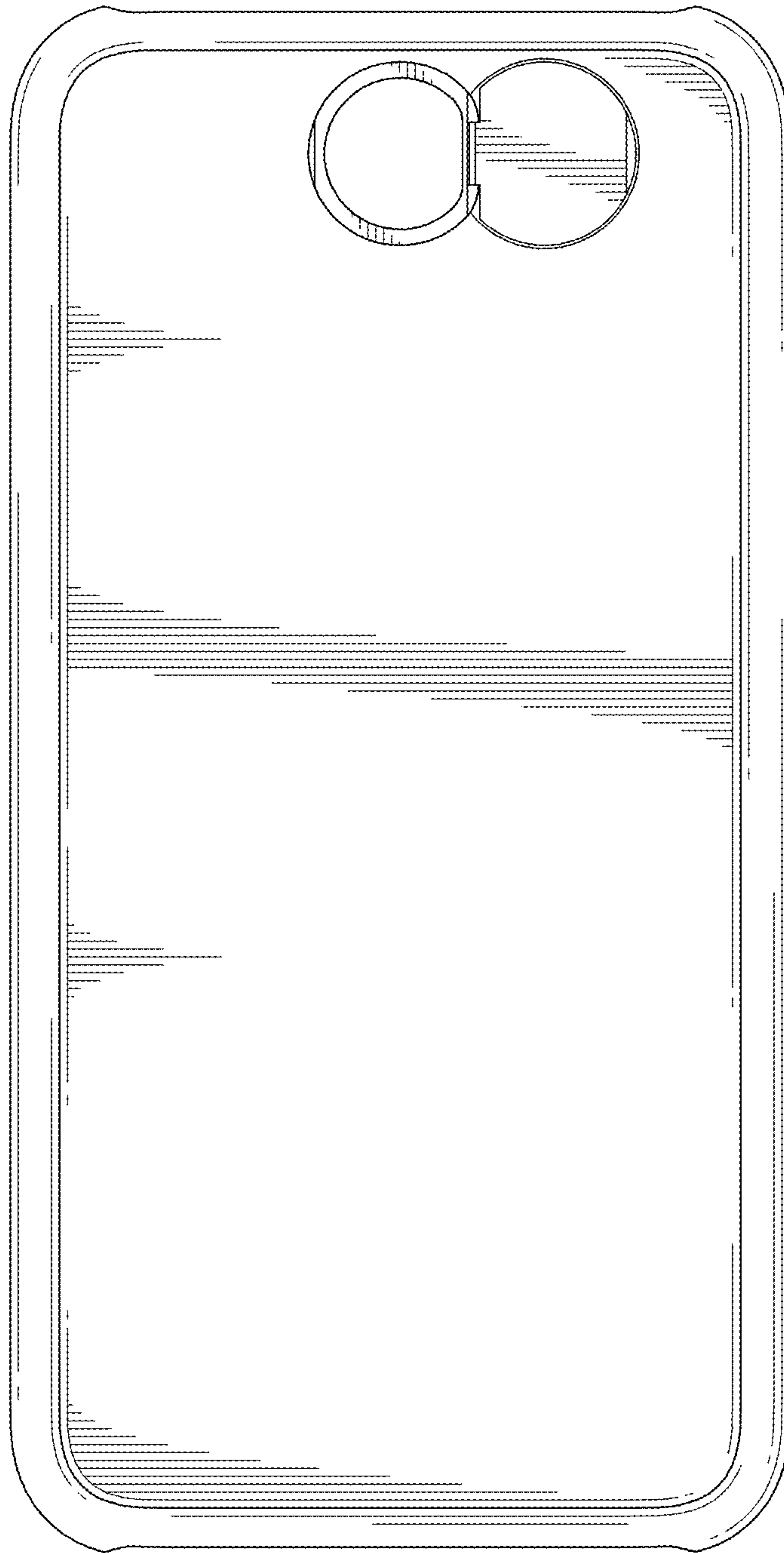

FIG. 106

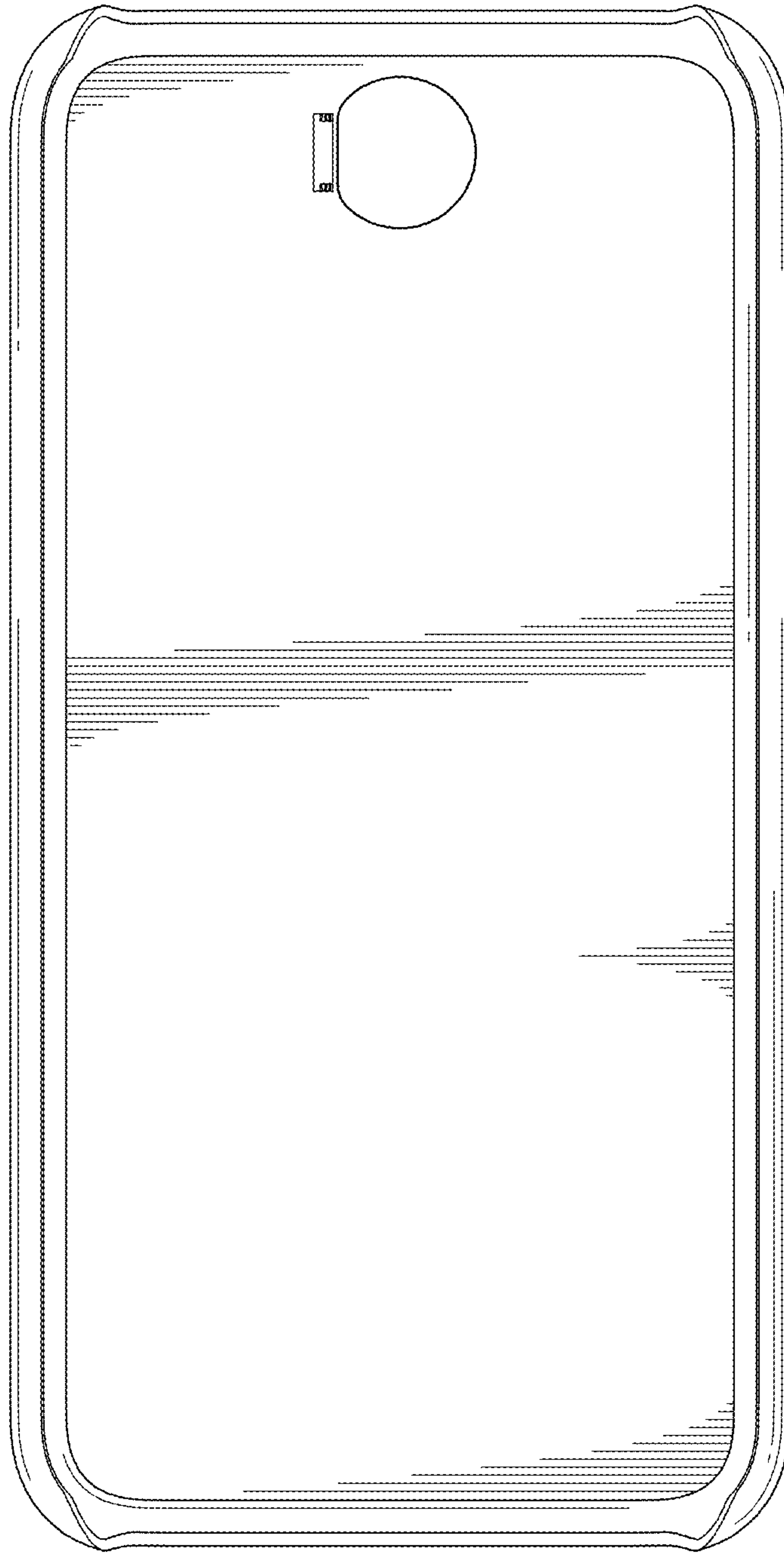

FIG. 107

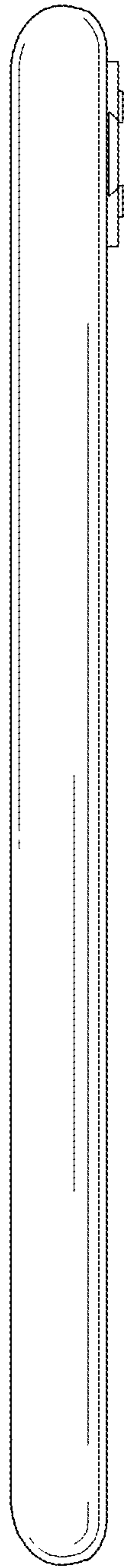

FIG. 108

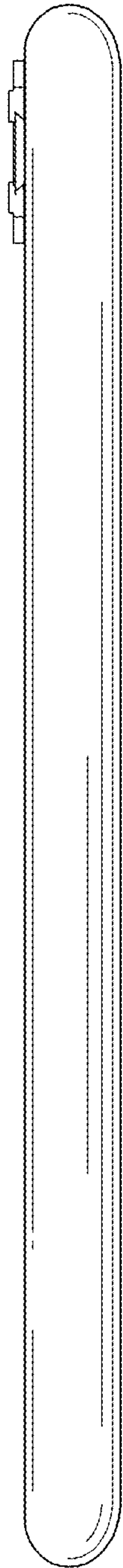

FIG. 109

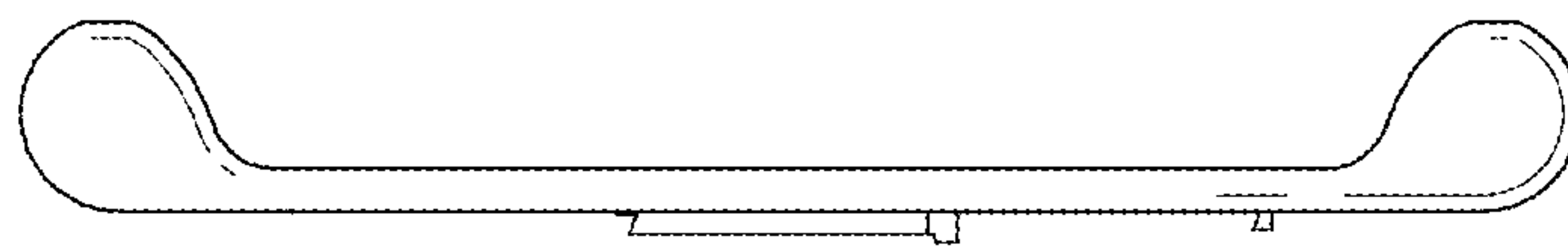

FIG.110

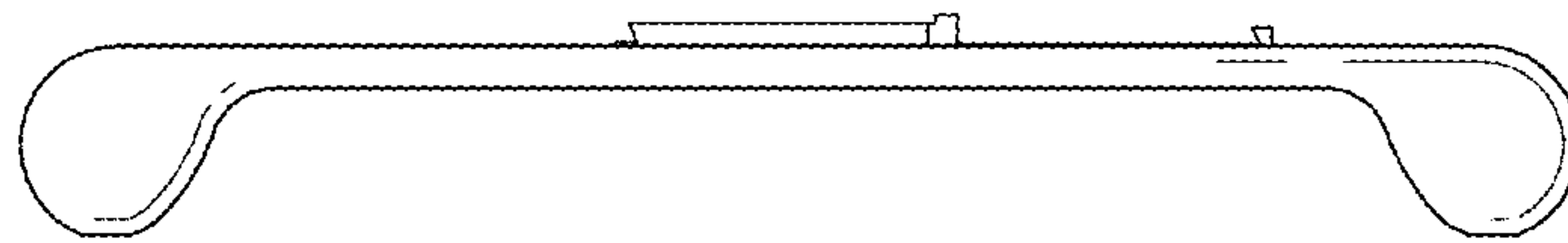

FIG.111

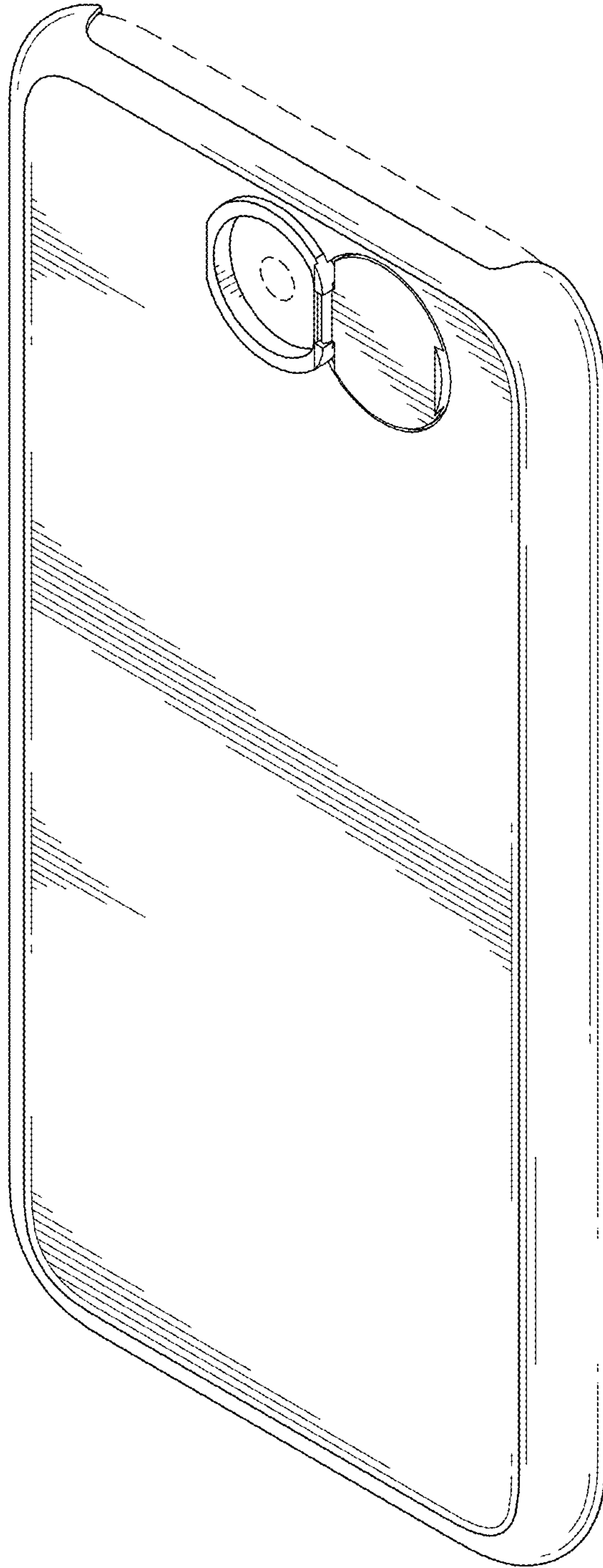

FIG.112

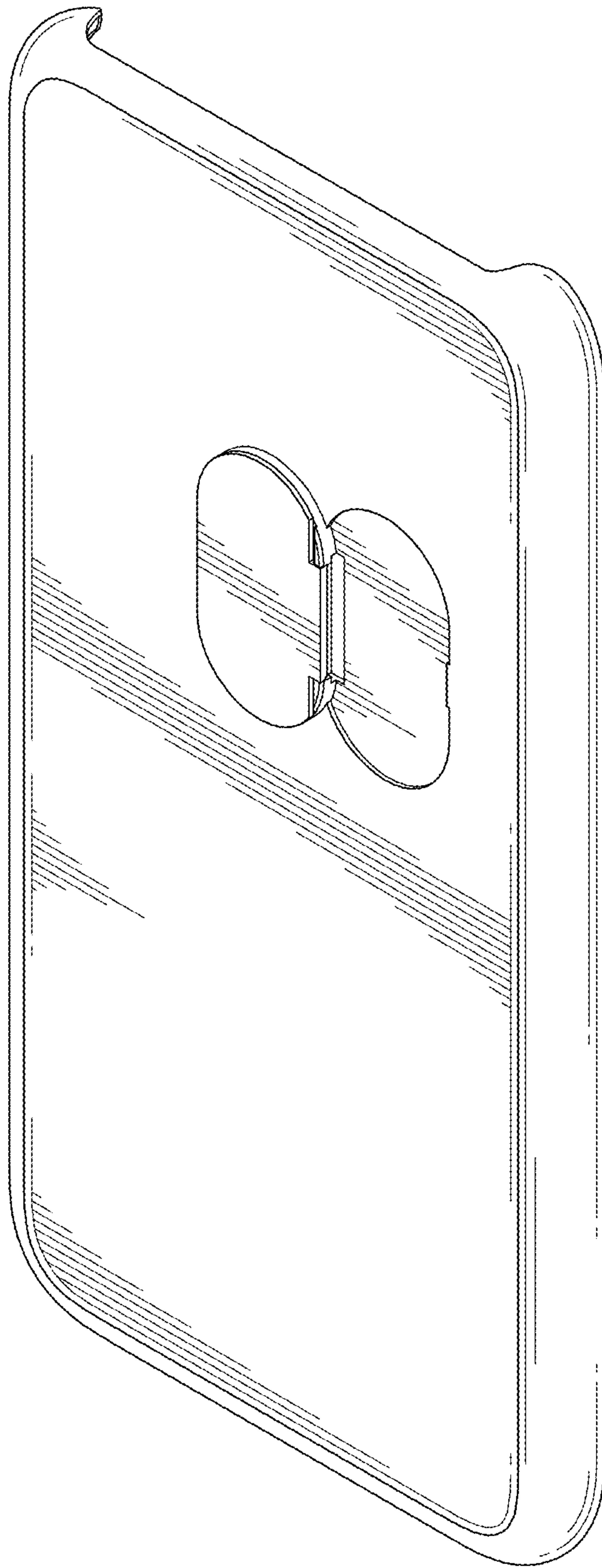

FIG.113

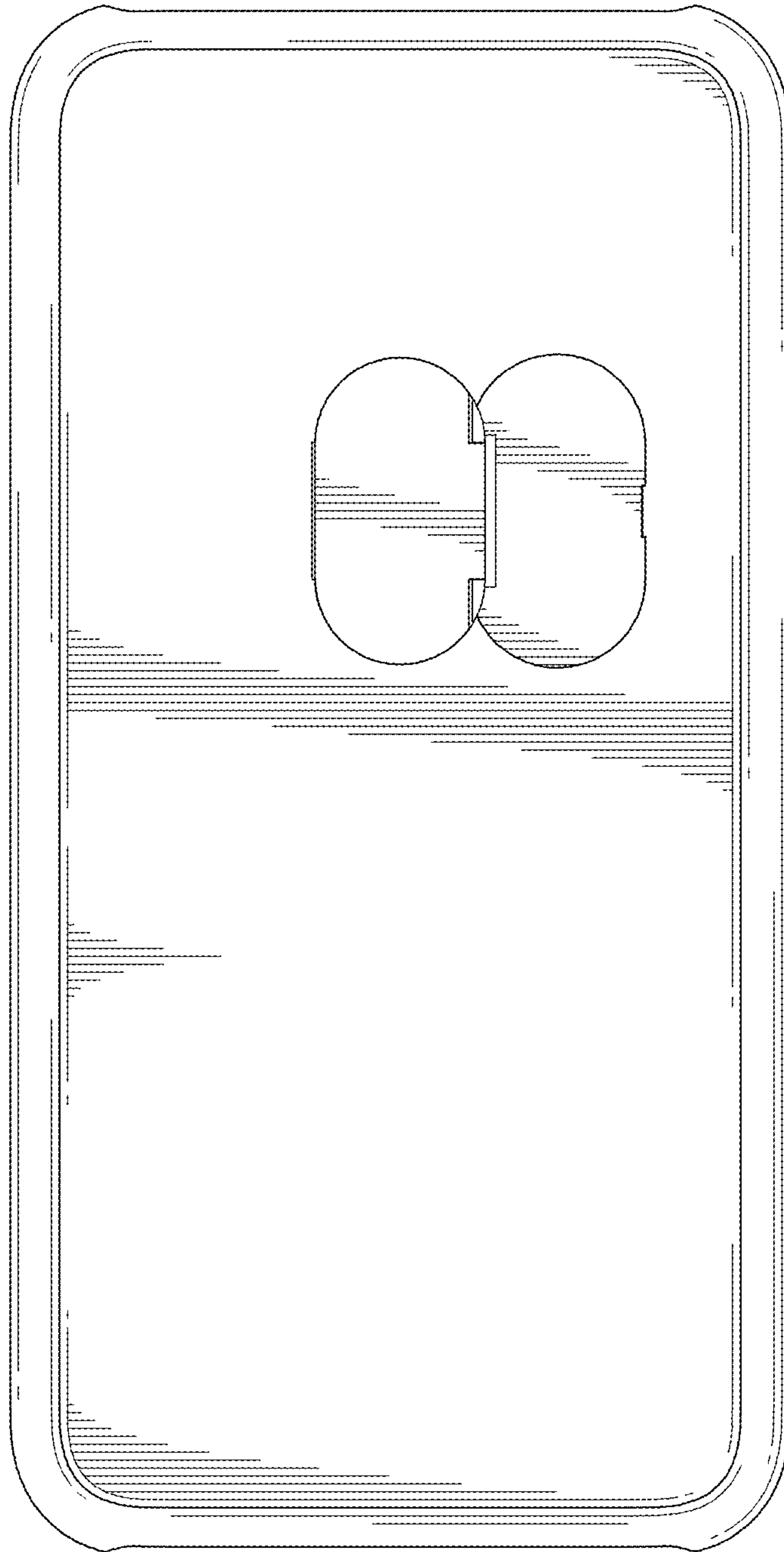

FIG.114

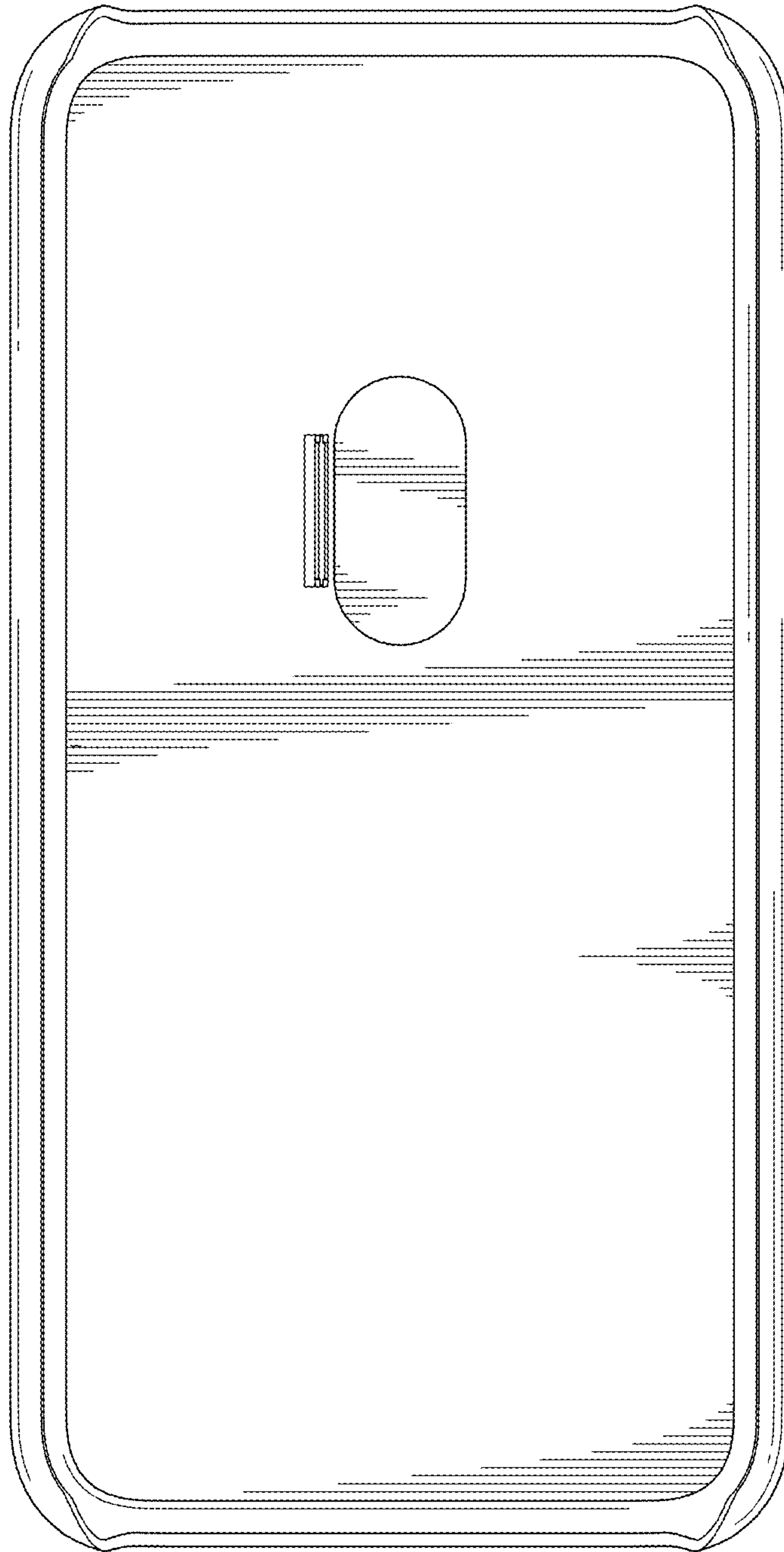

FIG. 115

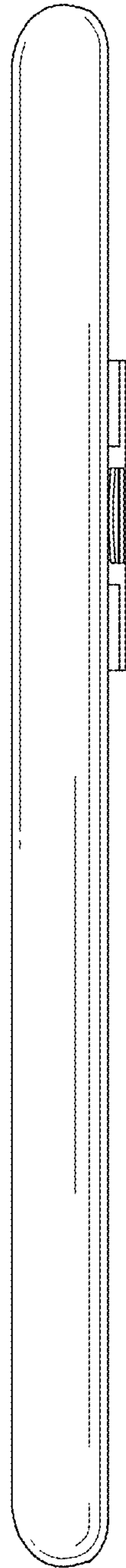

FIG.116

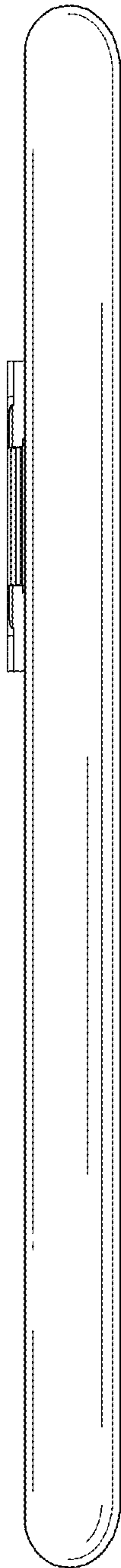

FIG. 117

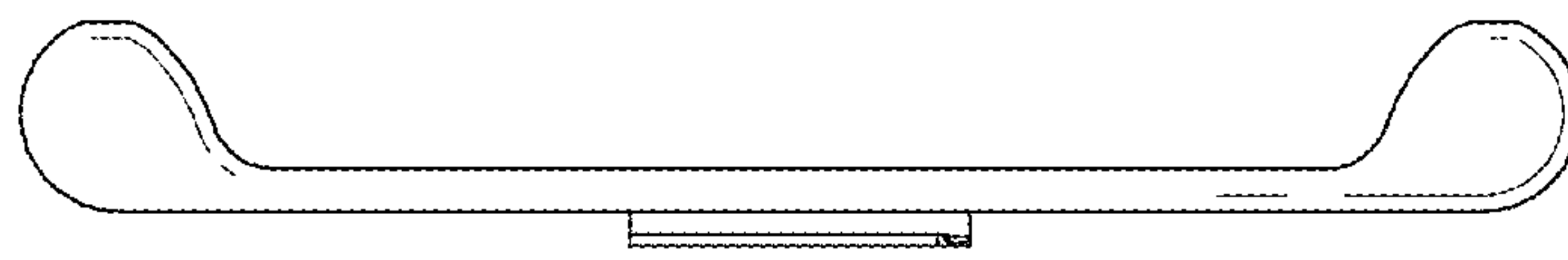

FIG. 118

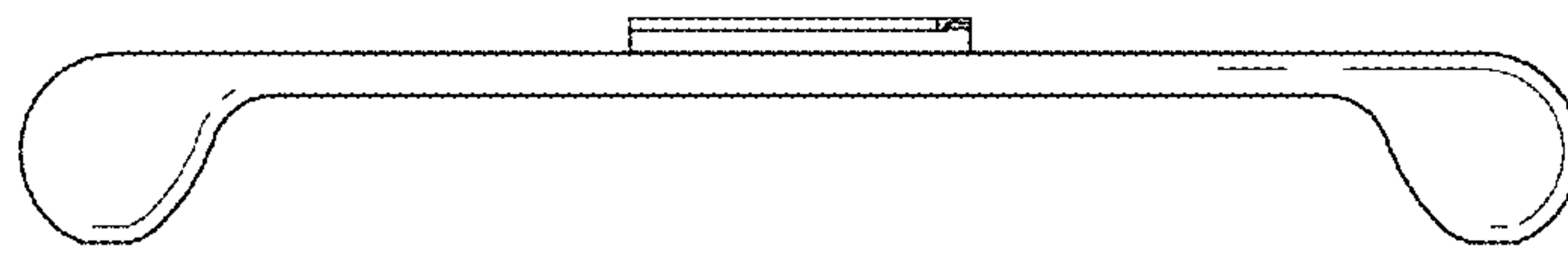

FIG.119

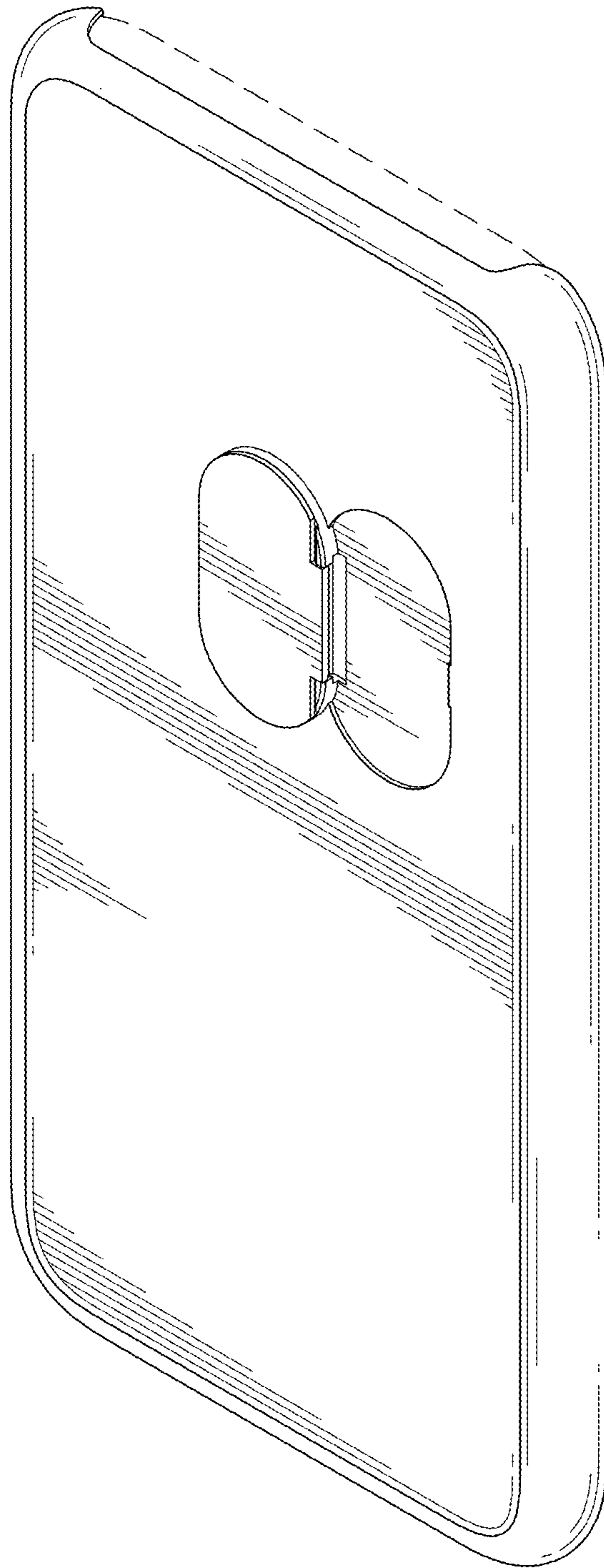

FIG. 120

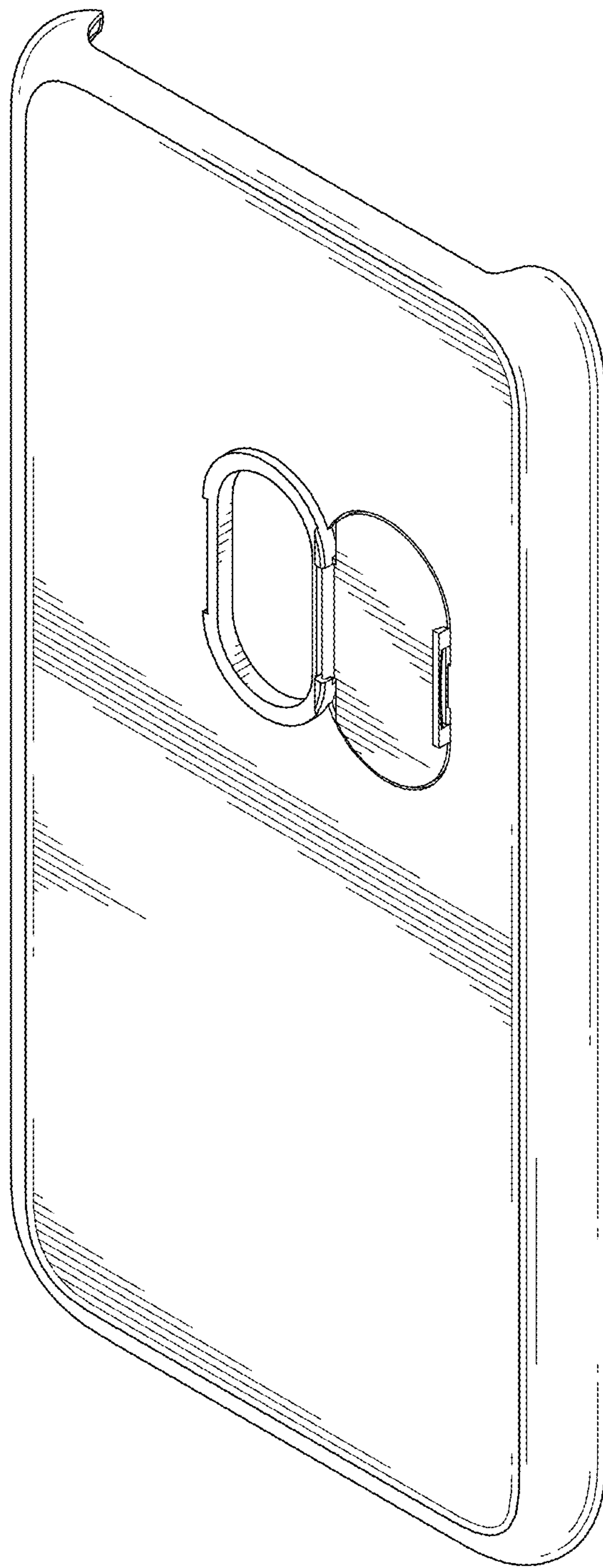

FIG.121

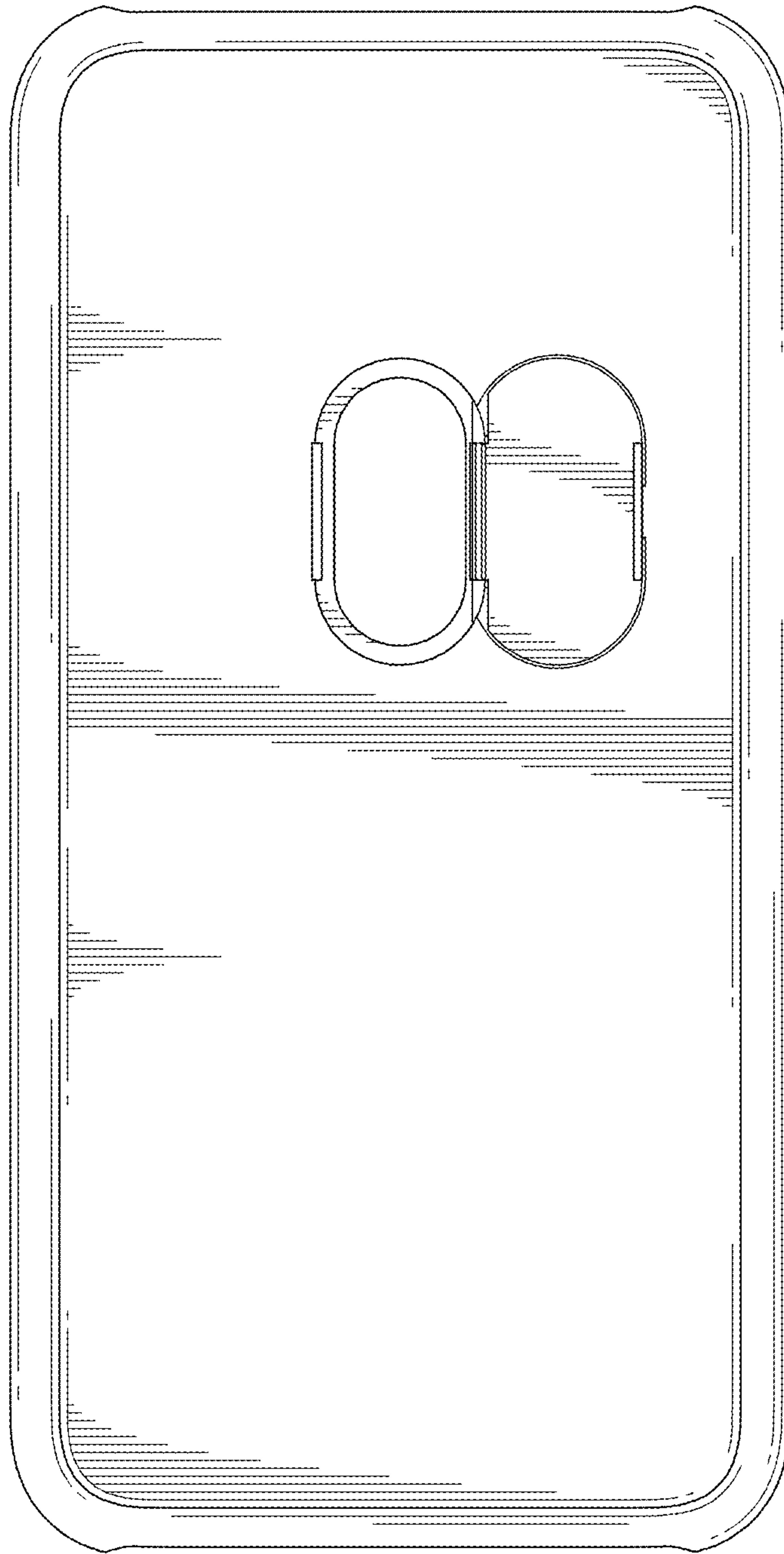

FIG. 122

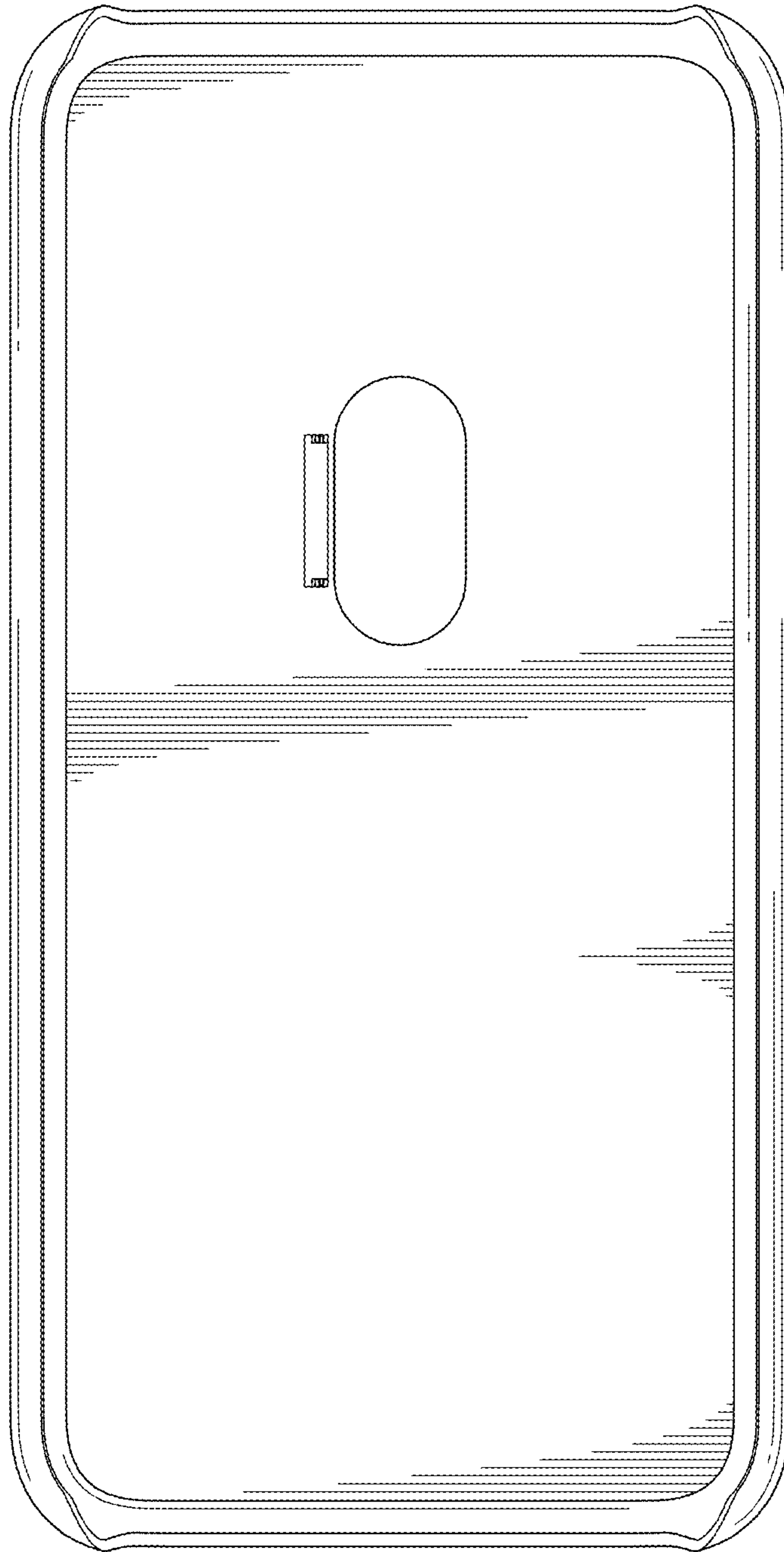

FIG.123

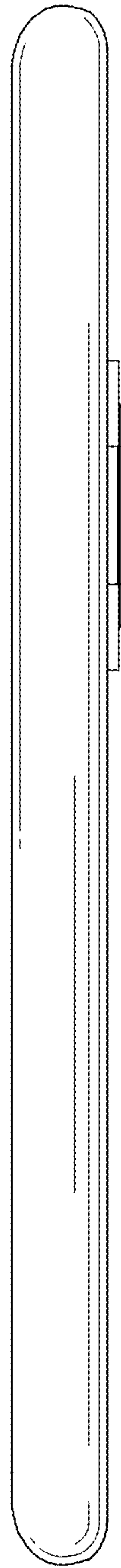

FIG. 124

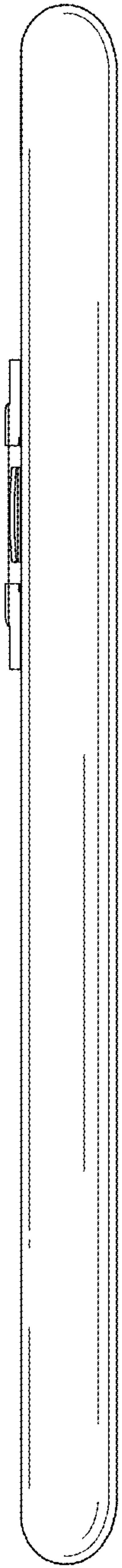

FIG. 125

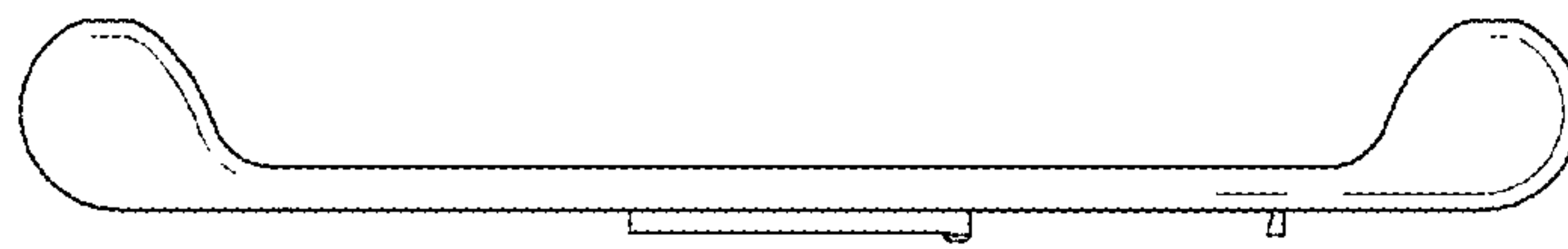

FIG.126

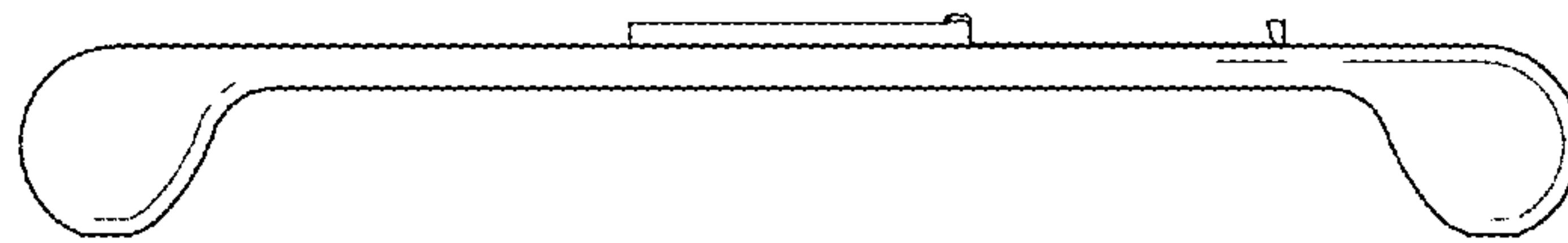

FIG.127

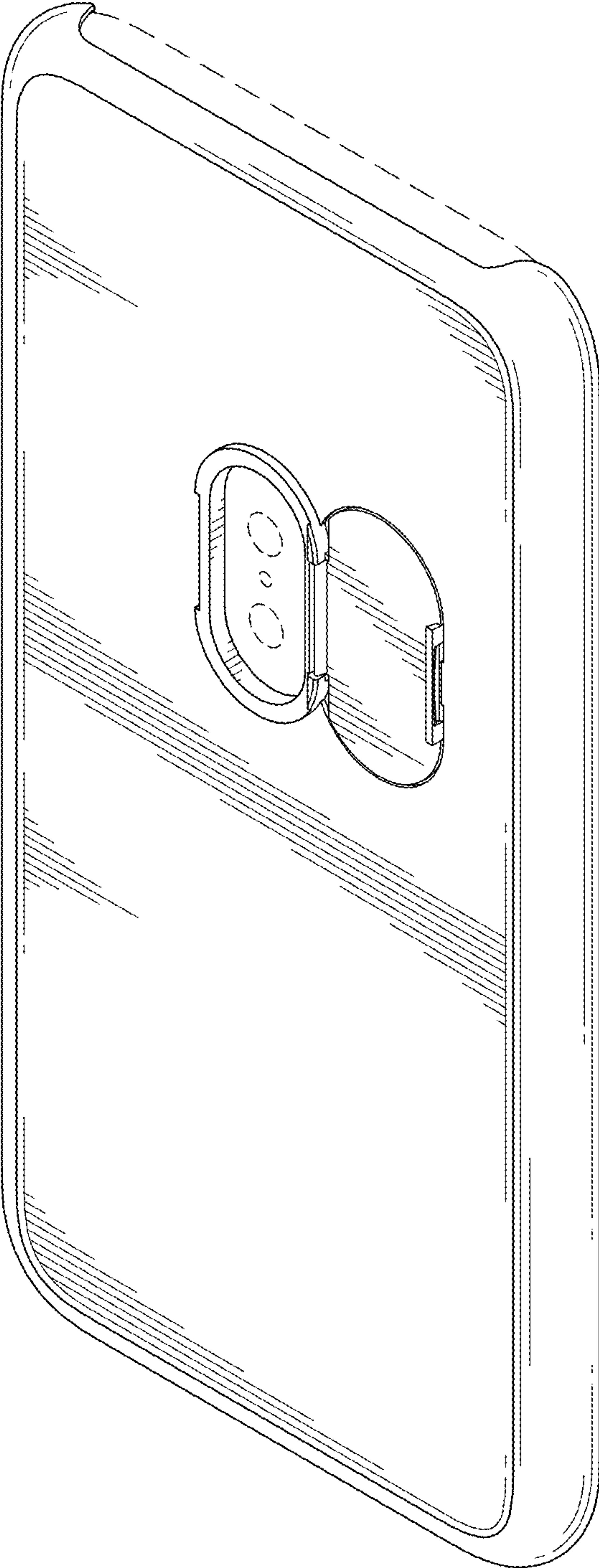

FIG.128

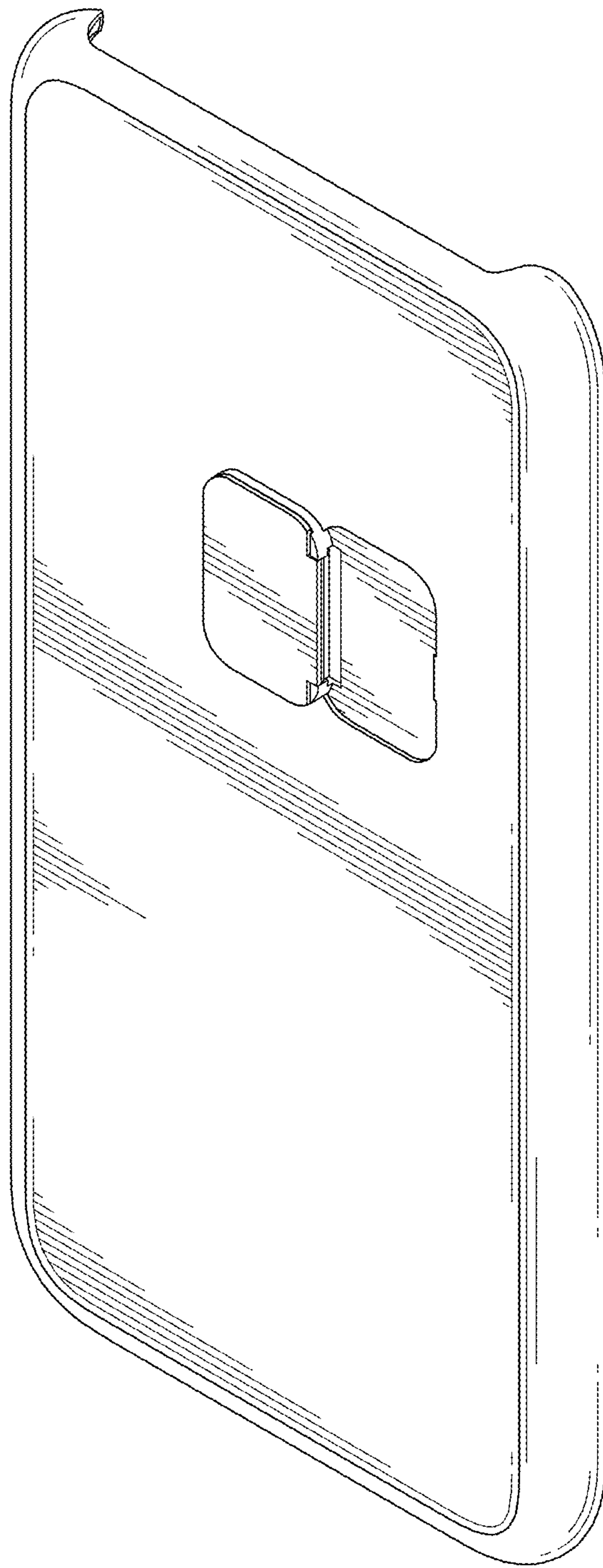

FIG.129

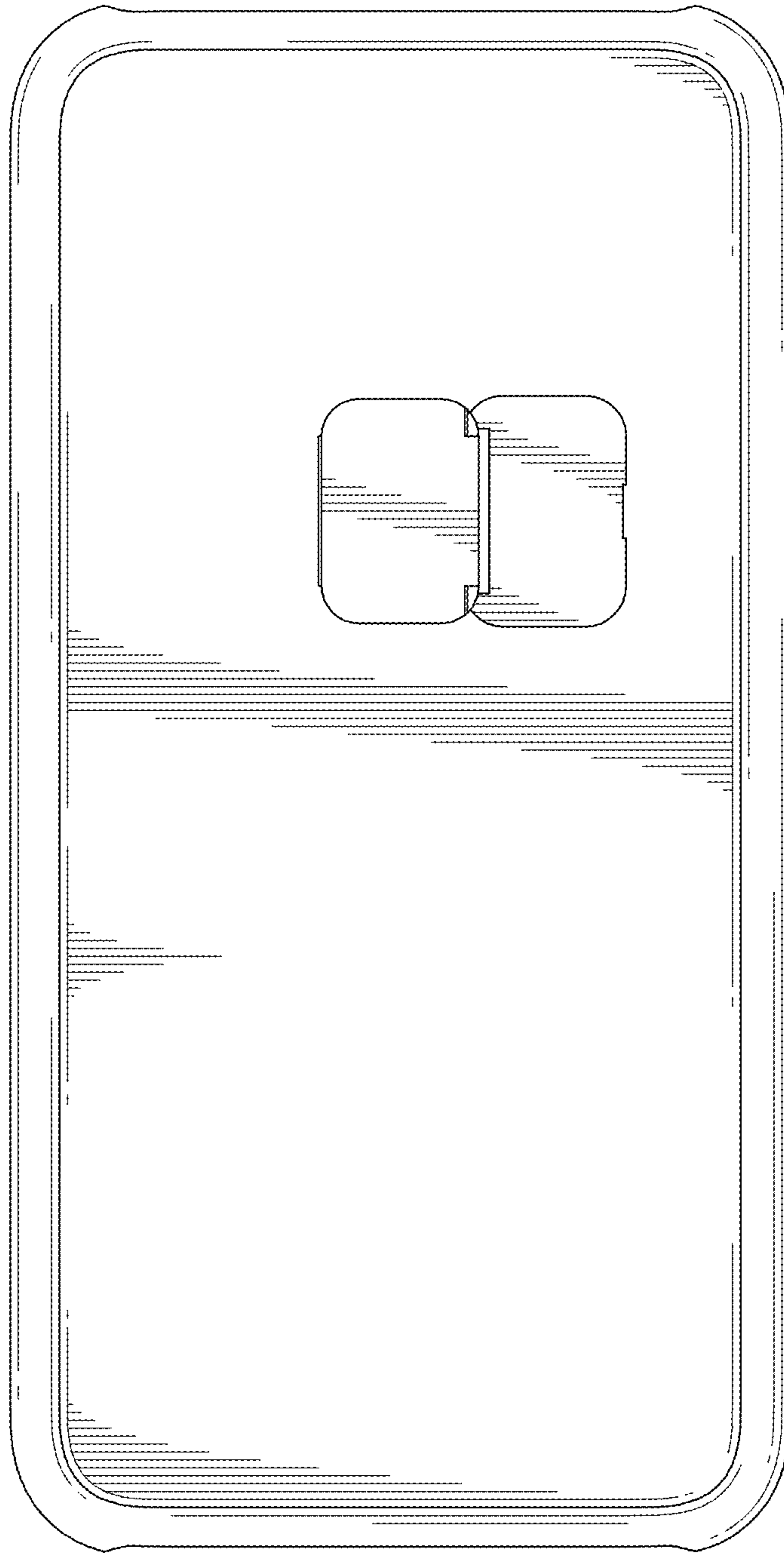

FIG.130

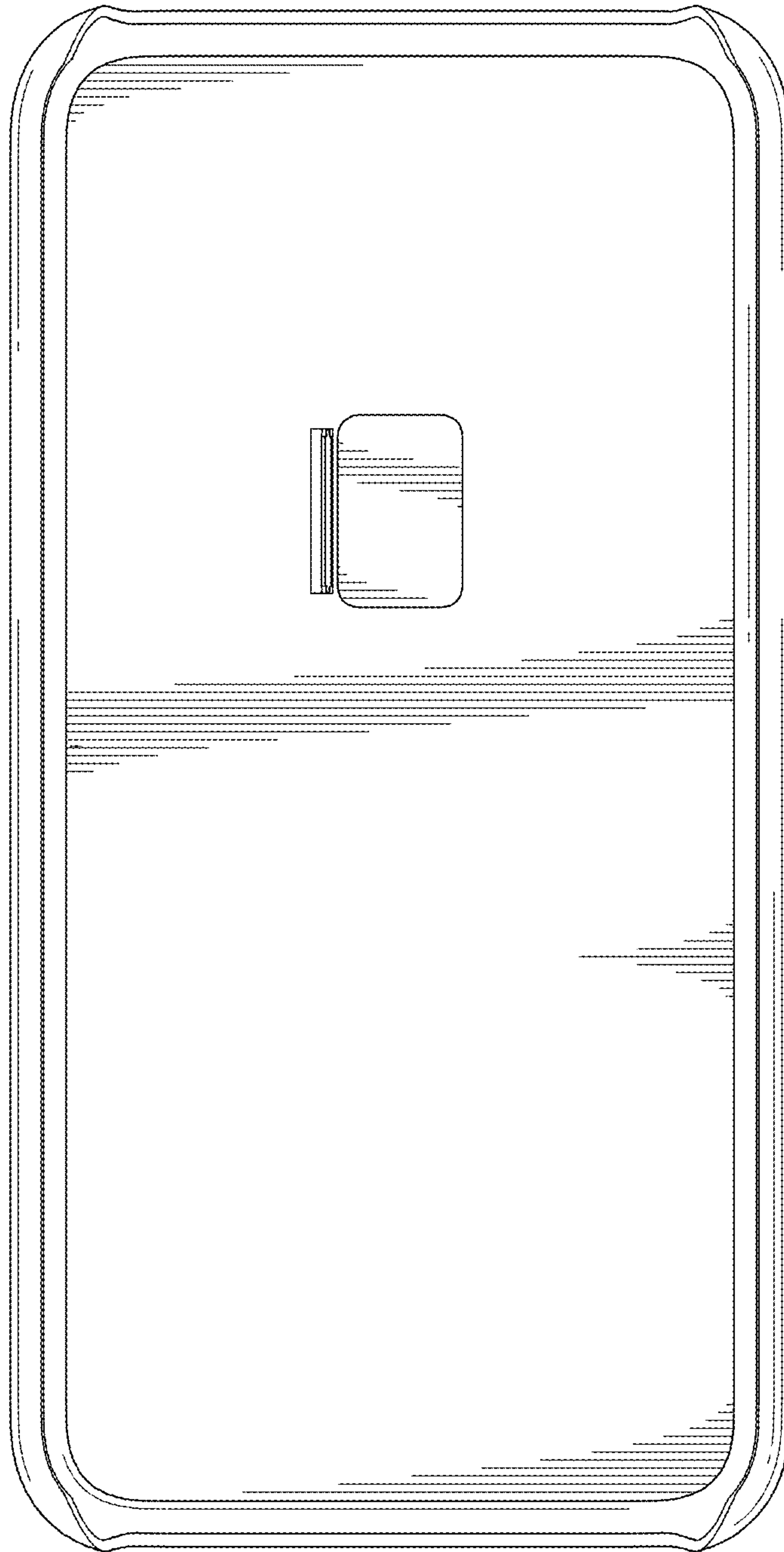

FIG.131

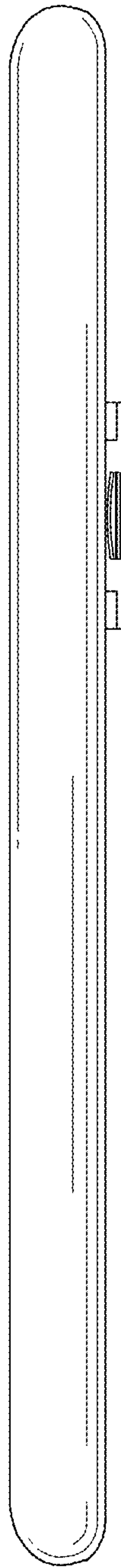

FIG.132

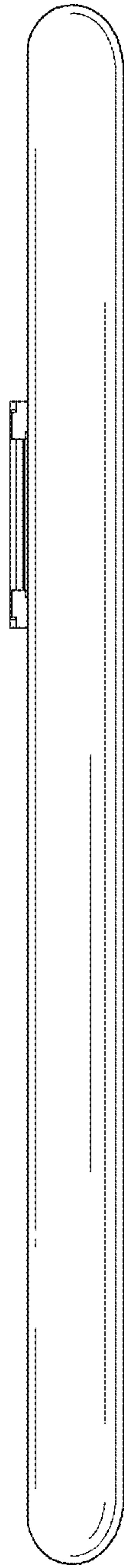

FIG.133

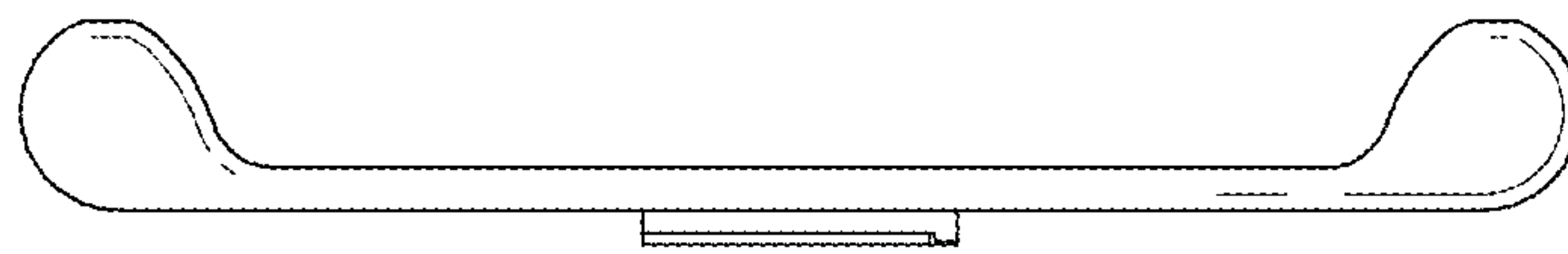

FIG.134

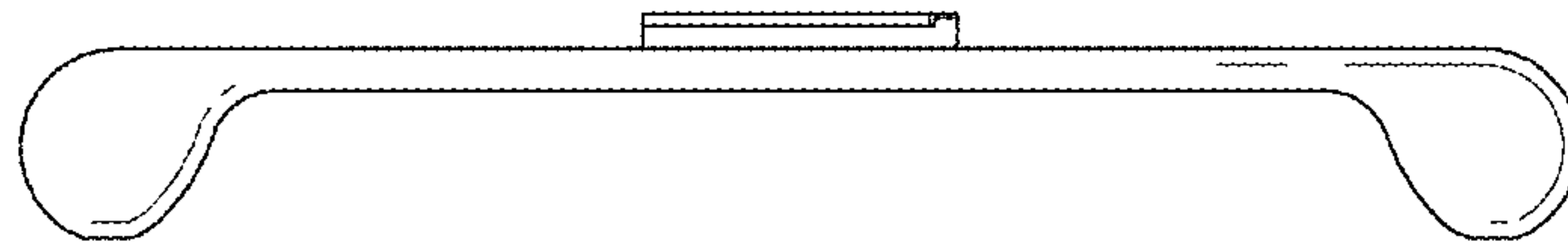

FIG.135

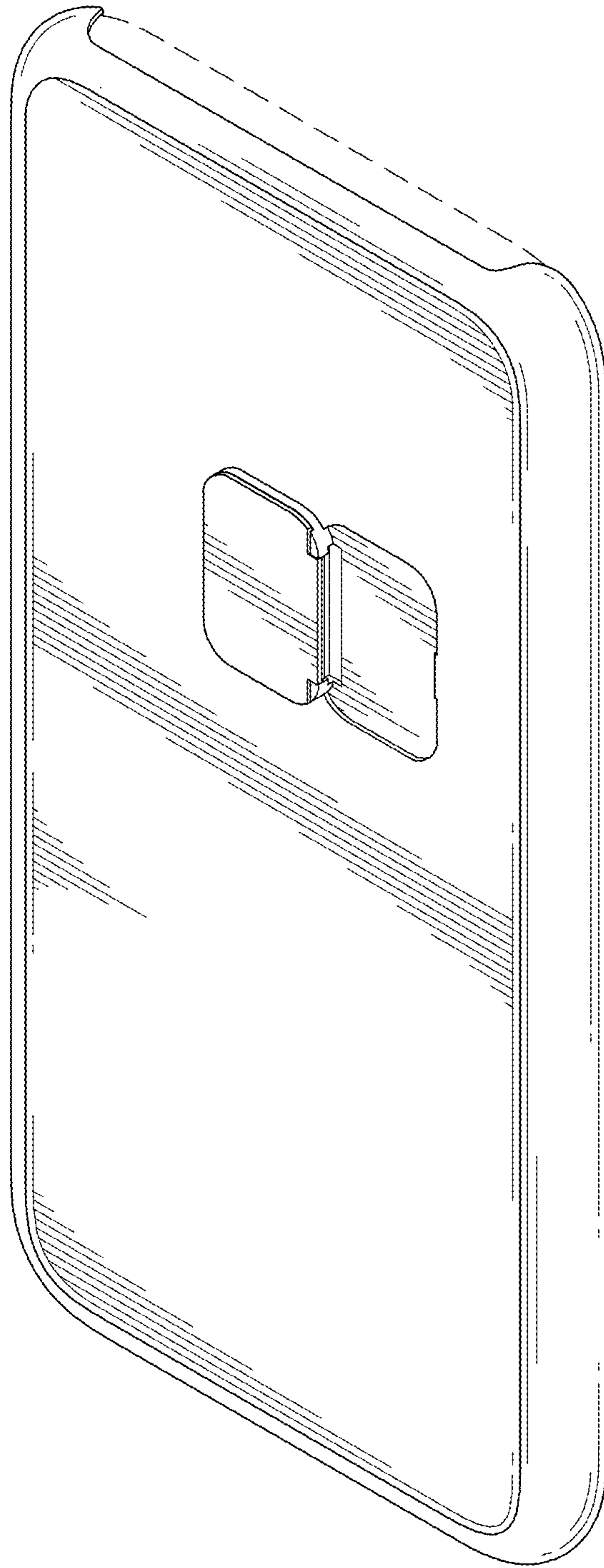

FIG.136

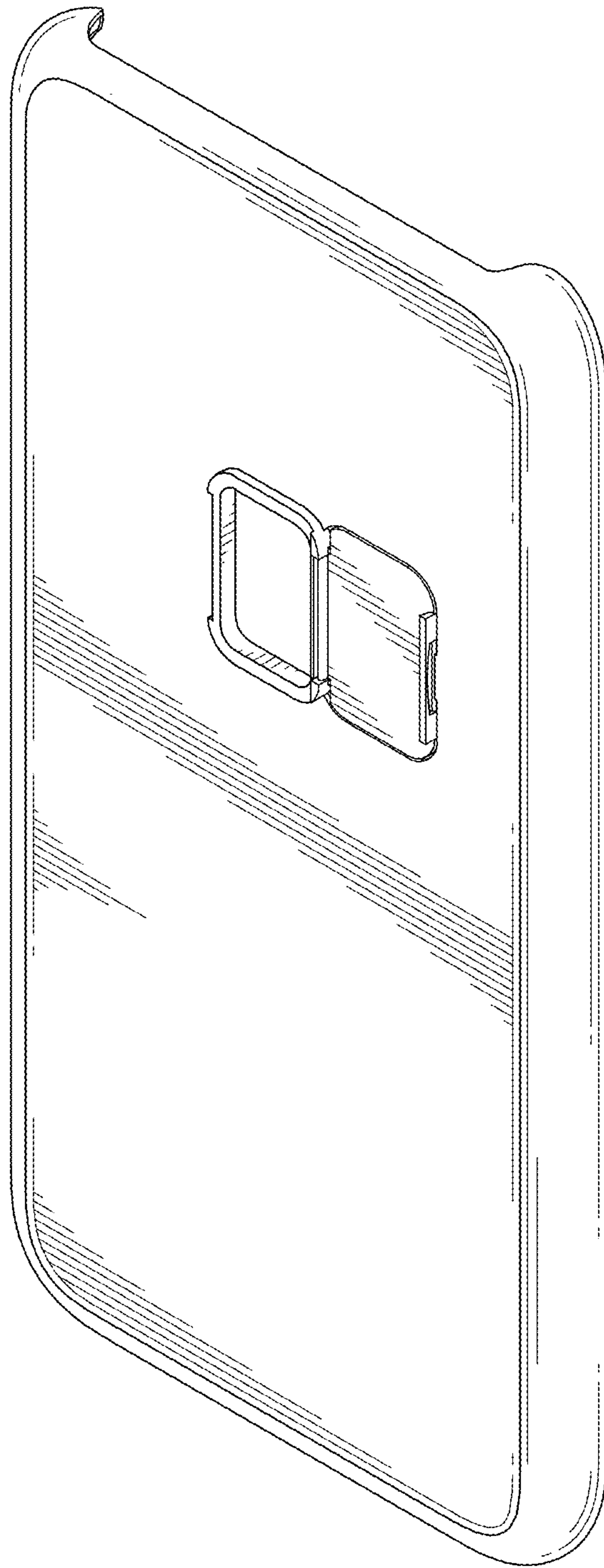

FIG.137

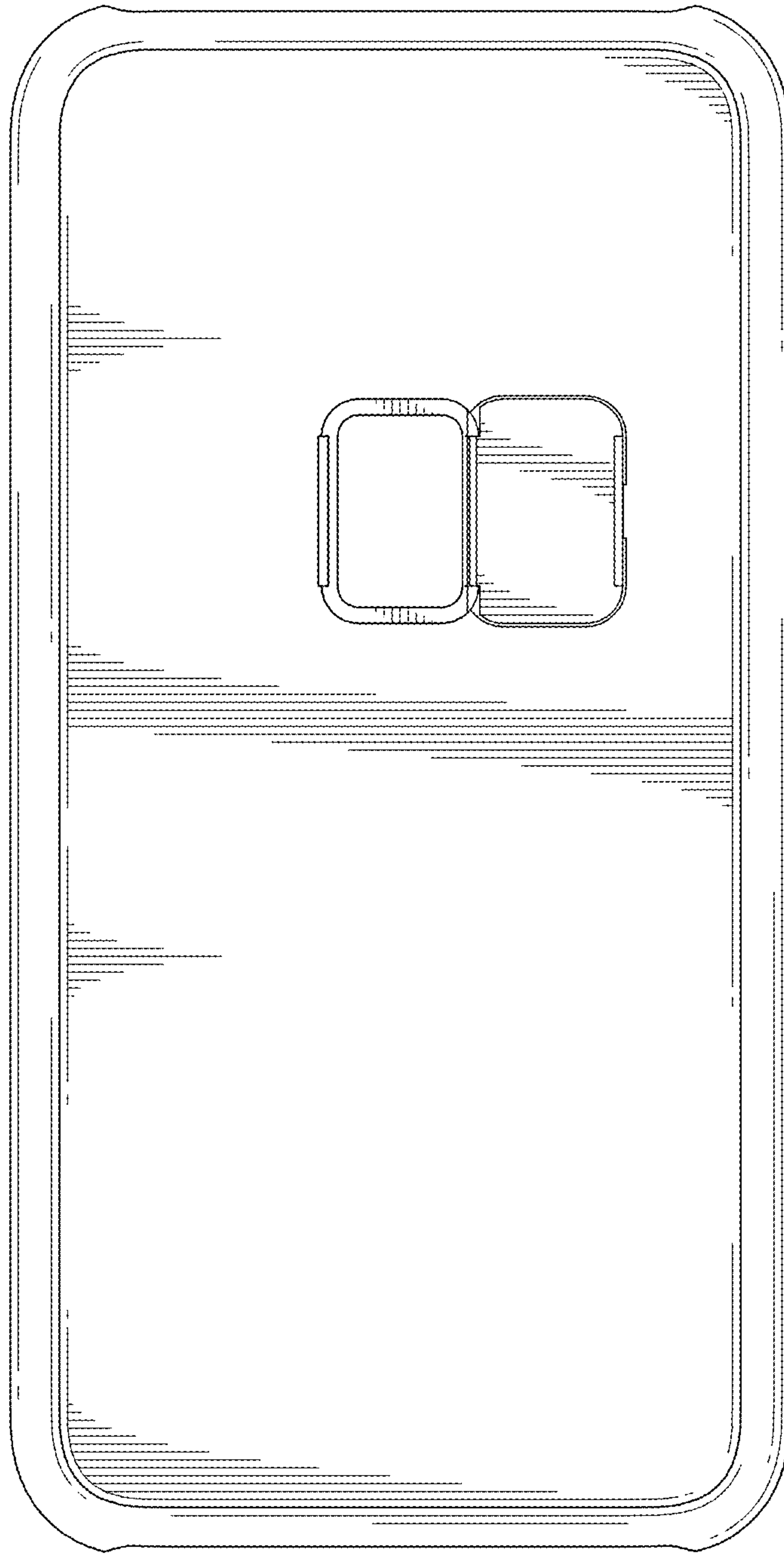

FIG.138

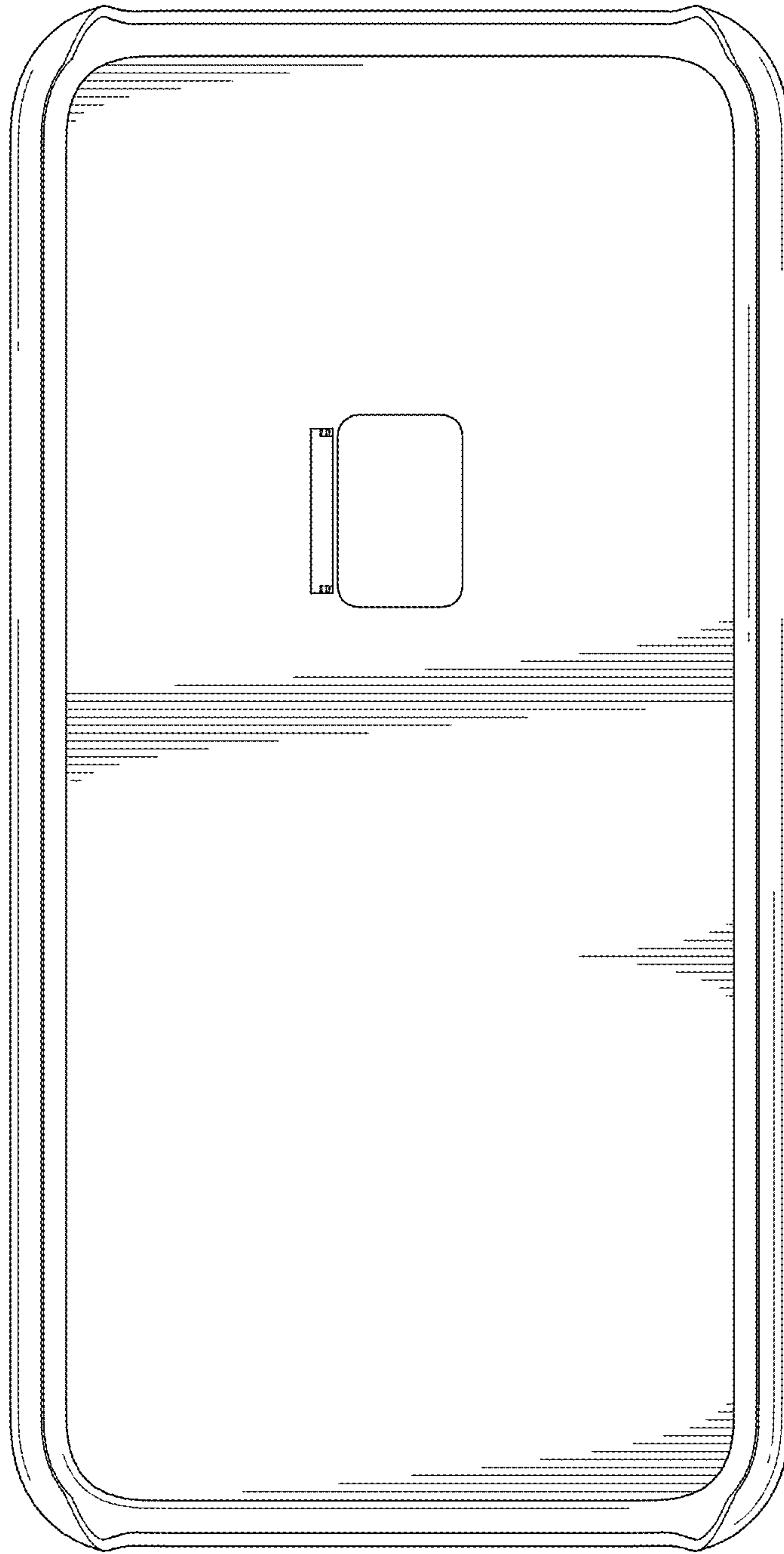

FIG.139

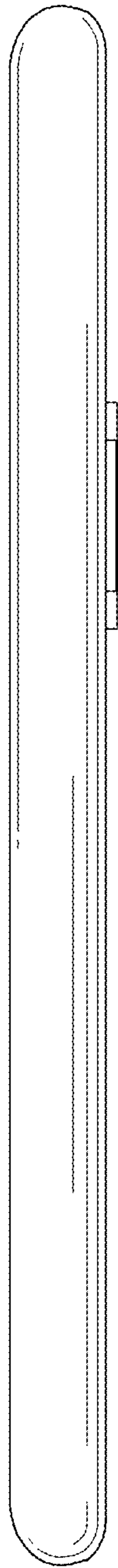

FIG.140

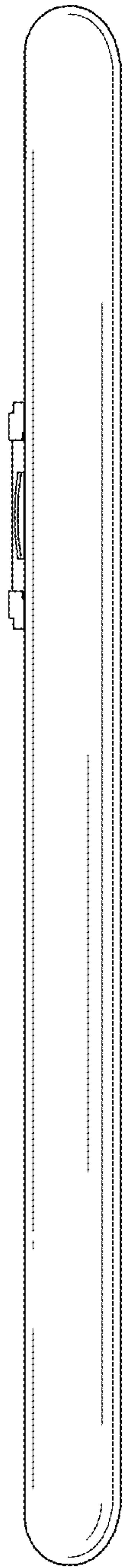

FIG.141

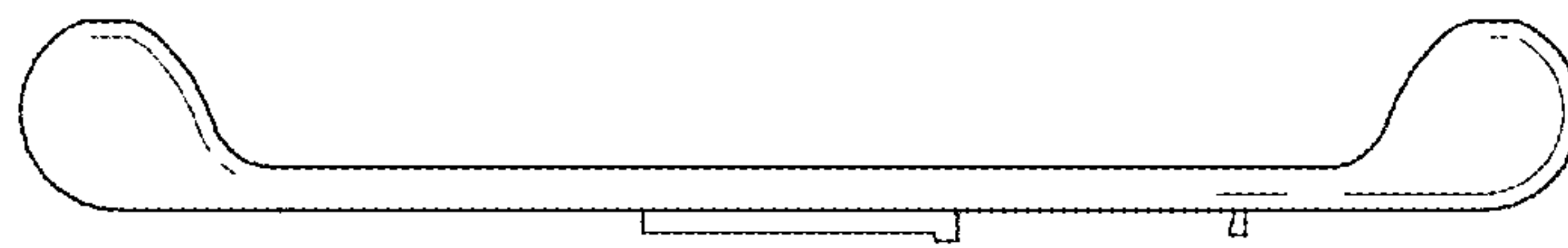

FIG.142

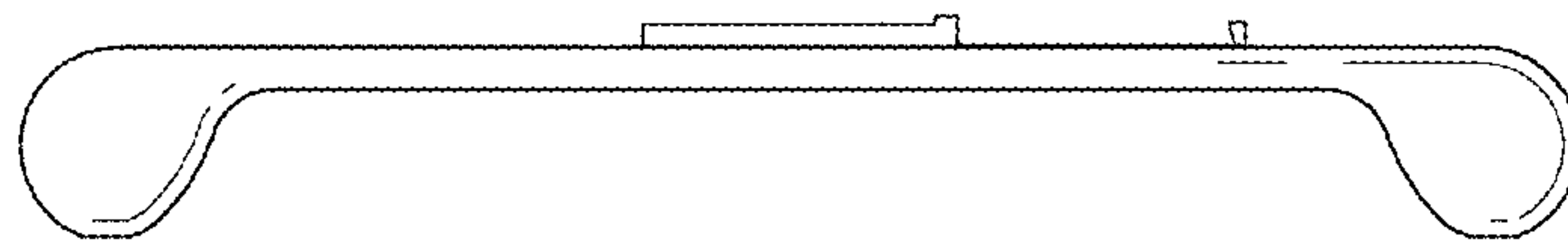

FIG.143

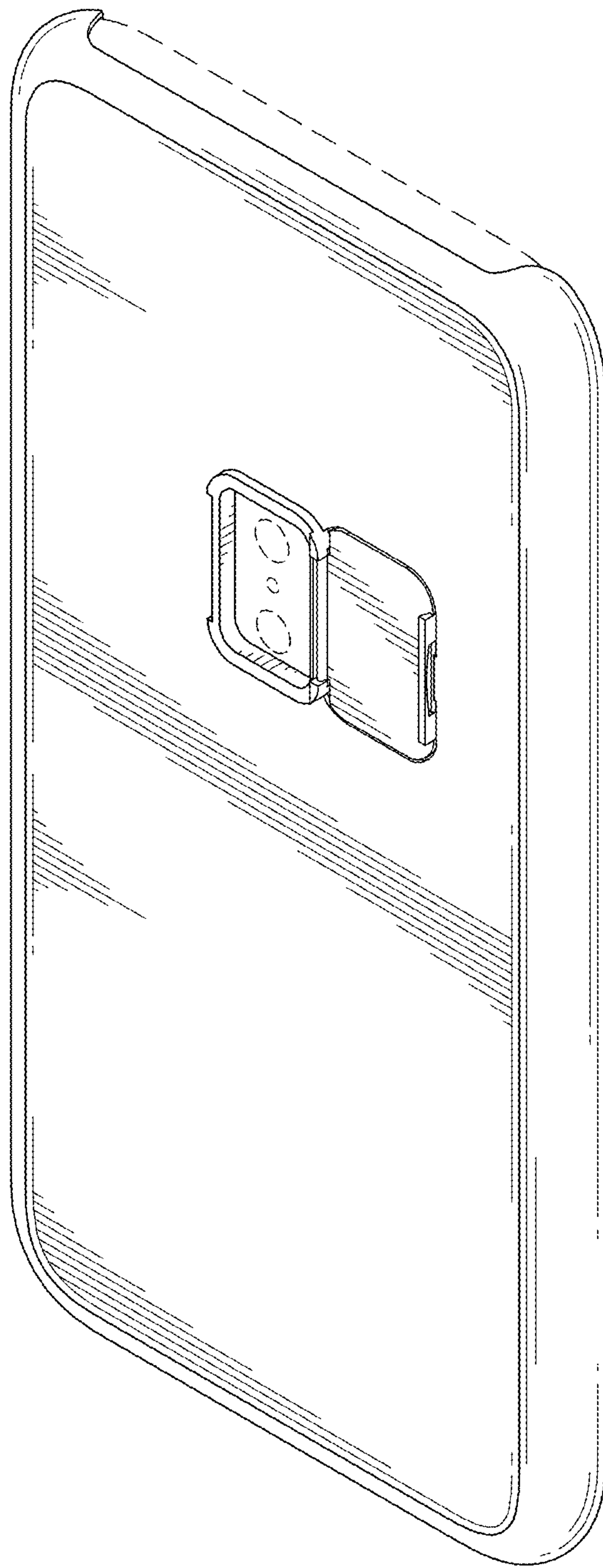

FIG.144

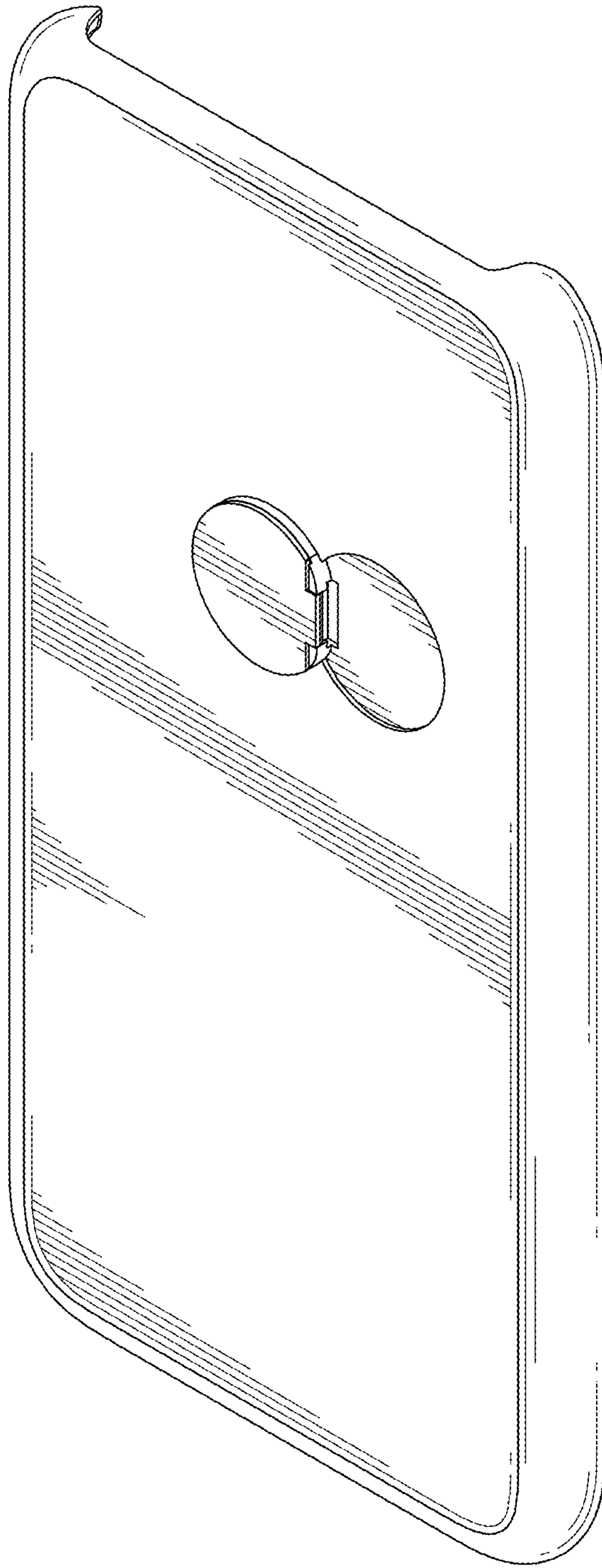

FIG.145

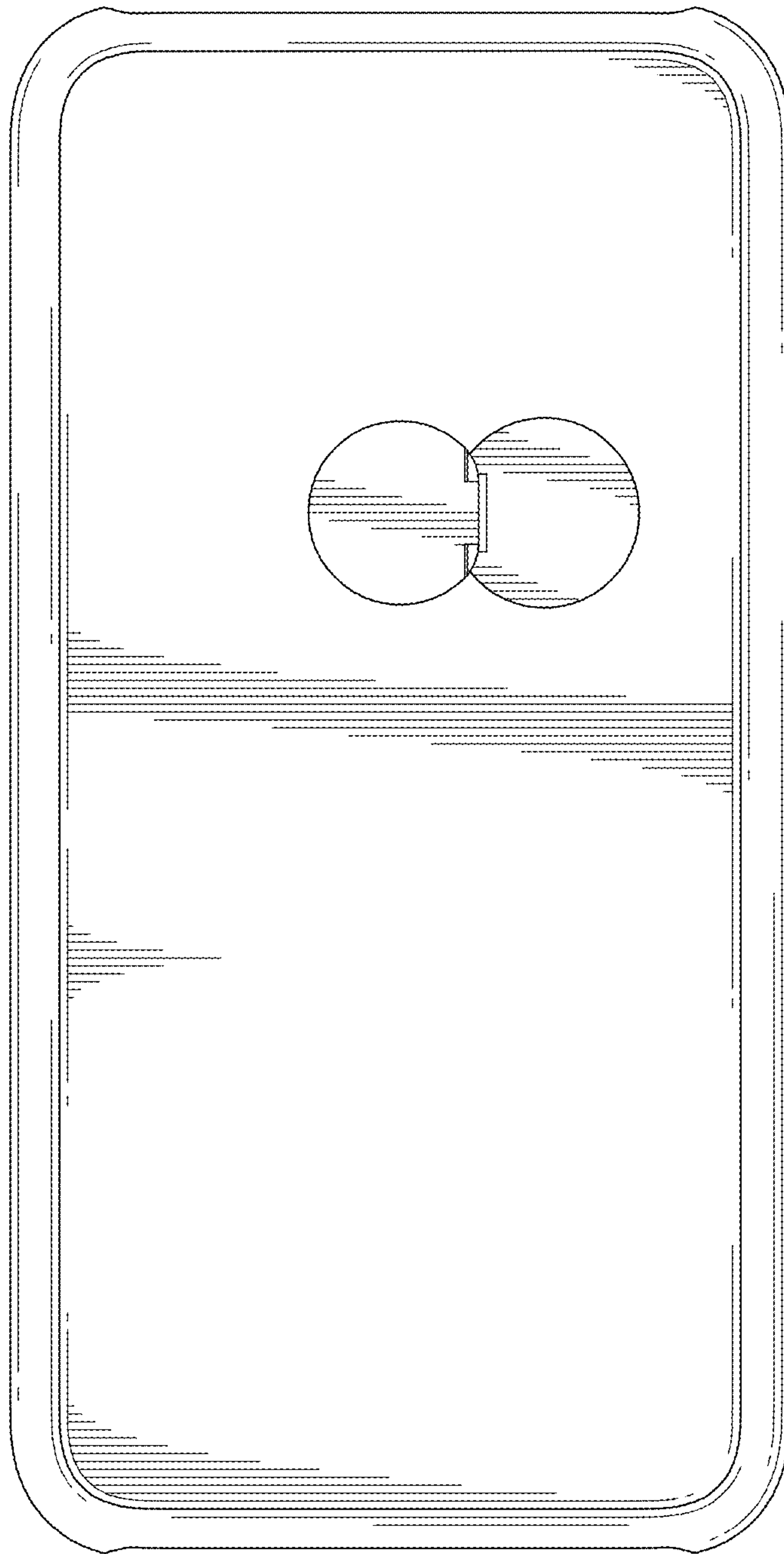

FIG.146

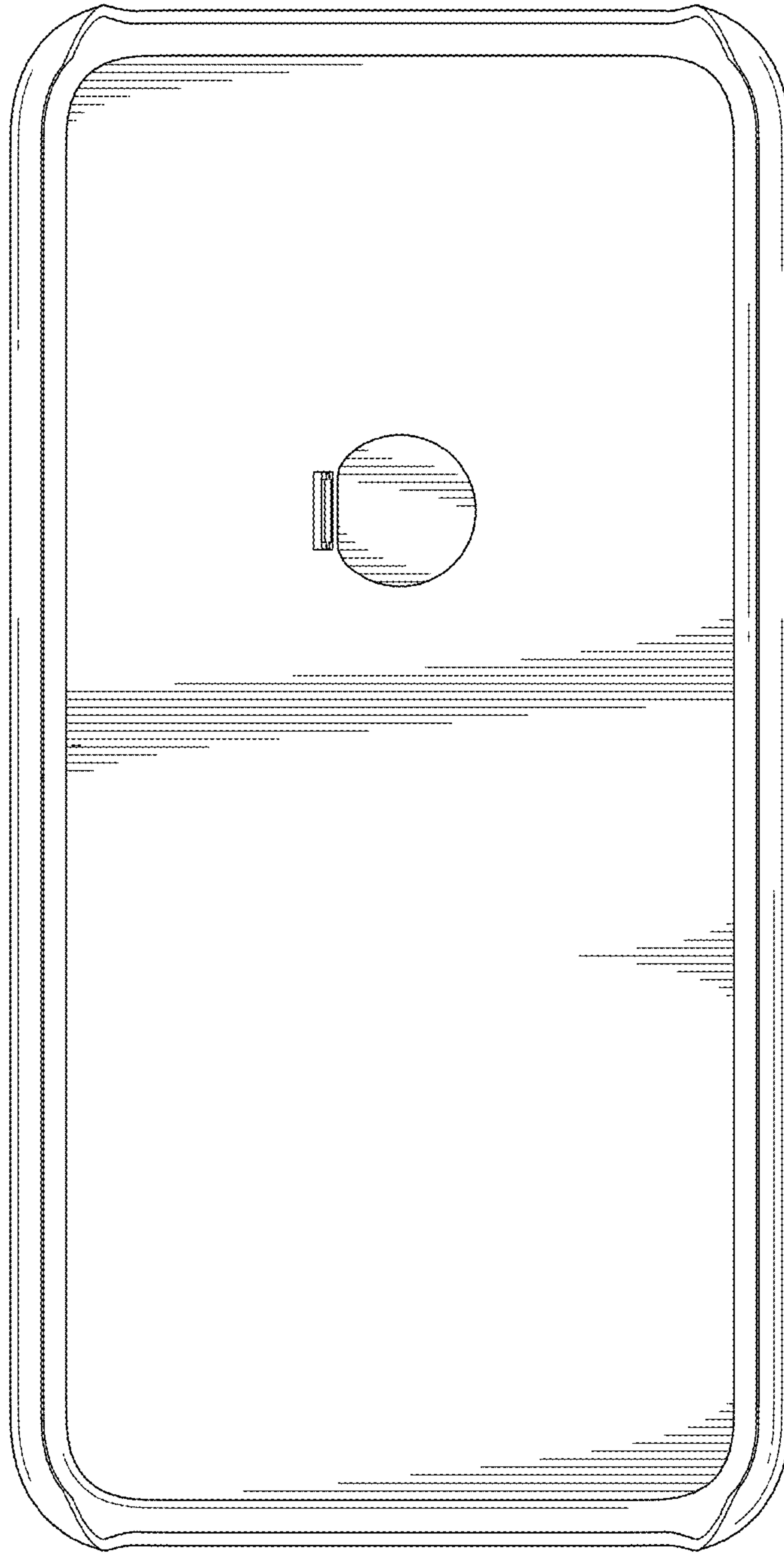

FIG.147

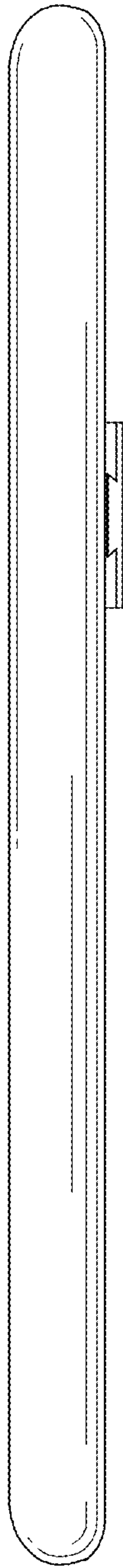

FIG.148

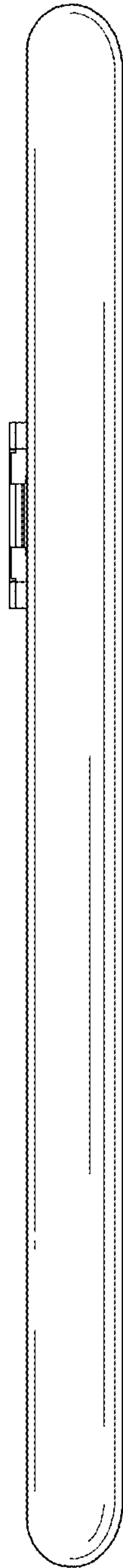

FIG. 149

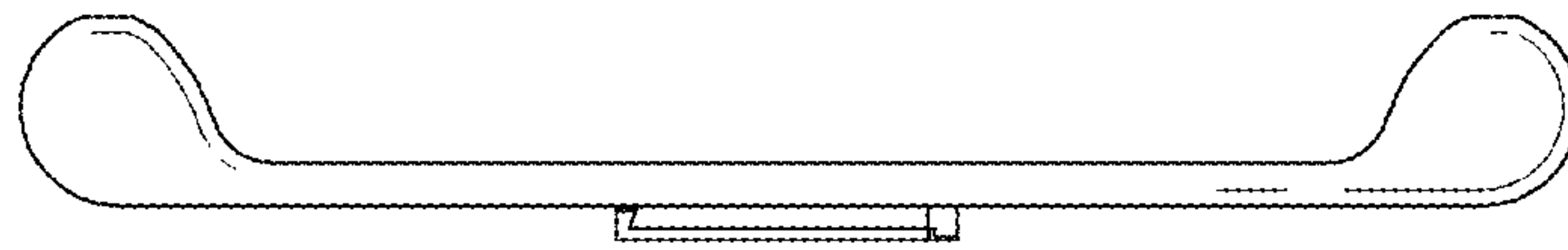

FIG.150



FIG.151

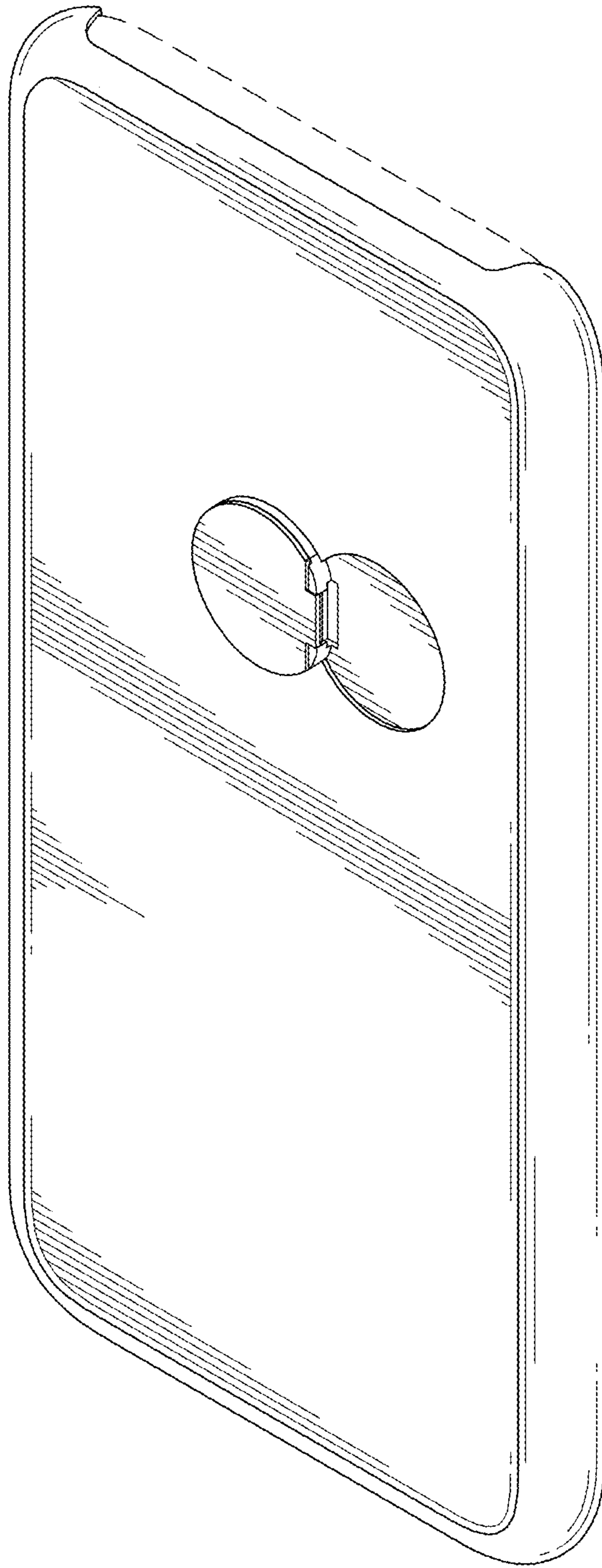

FIG.152

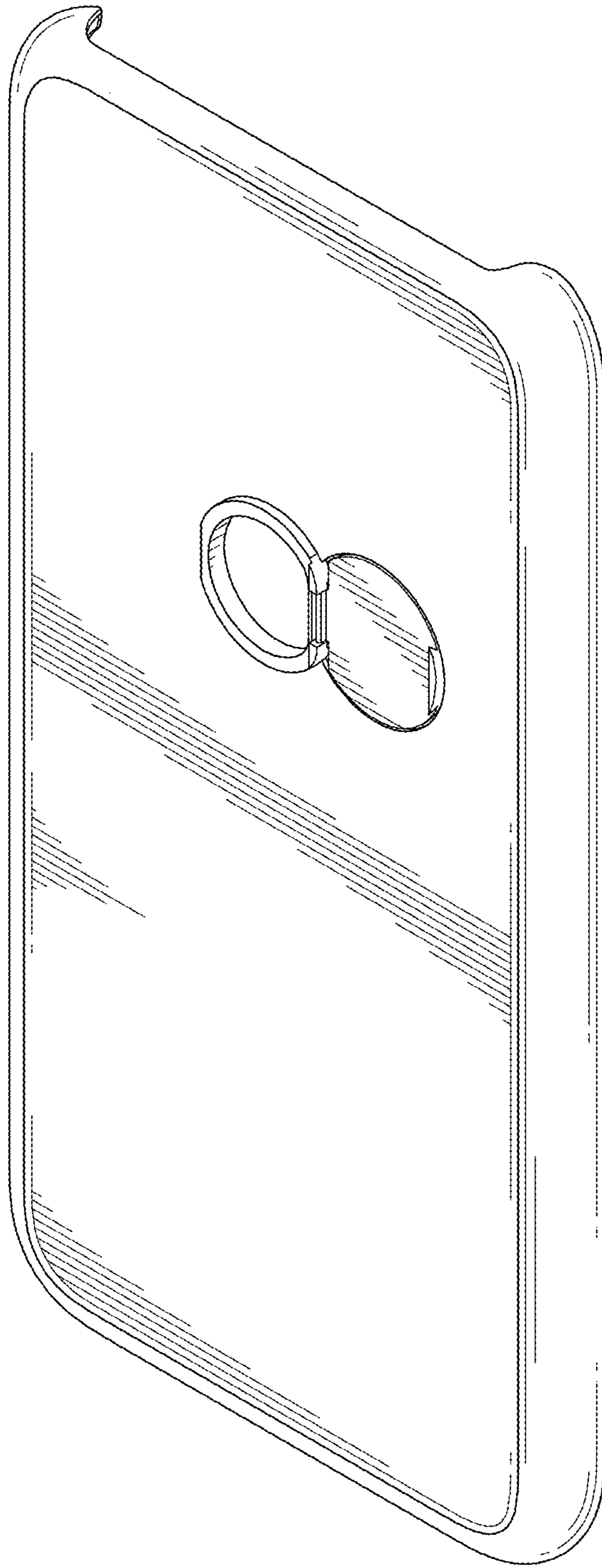

FIG.153

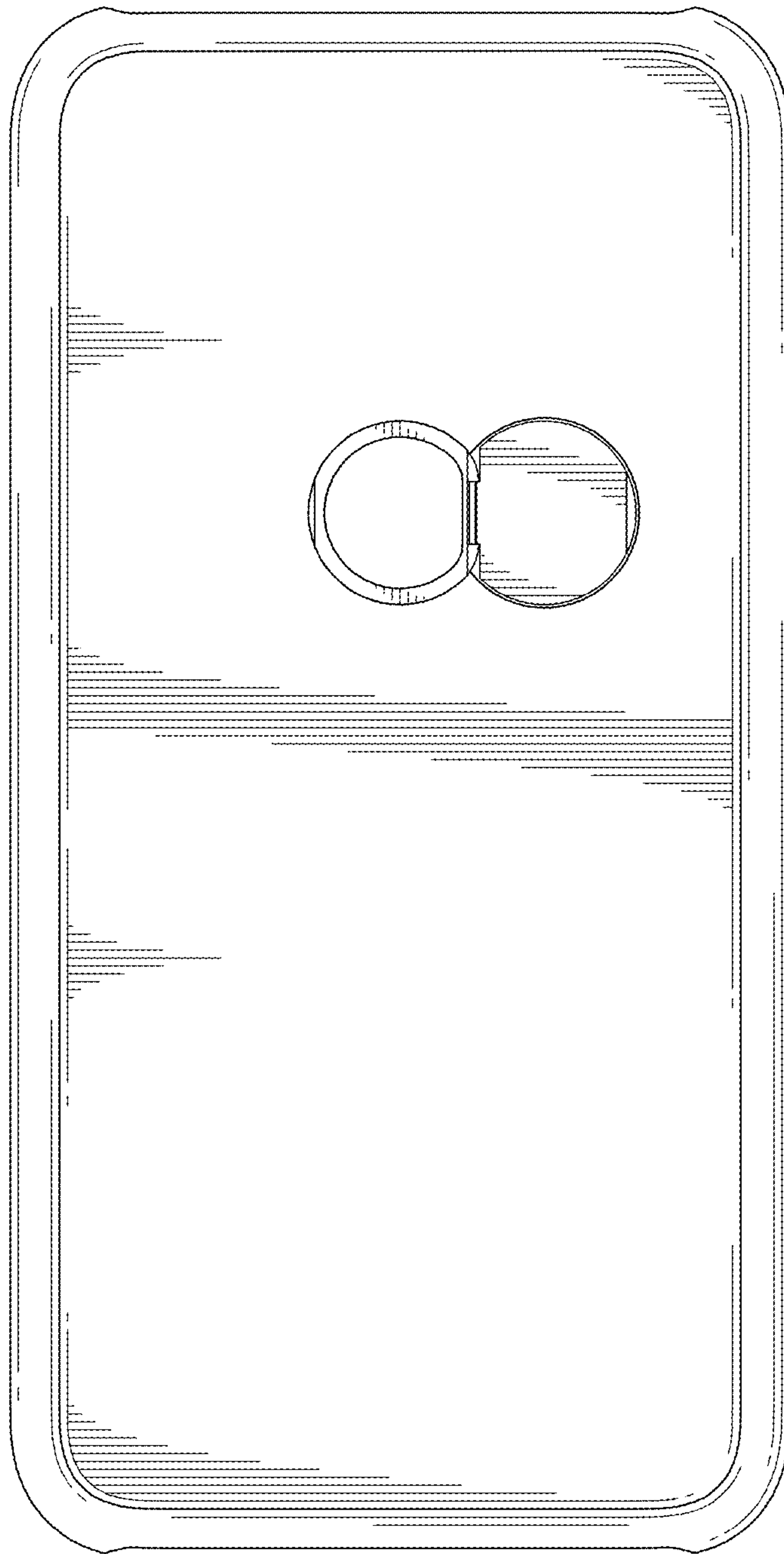

FIG.154

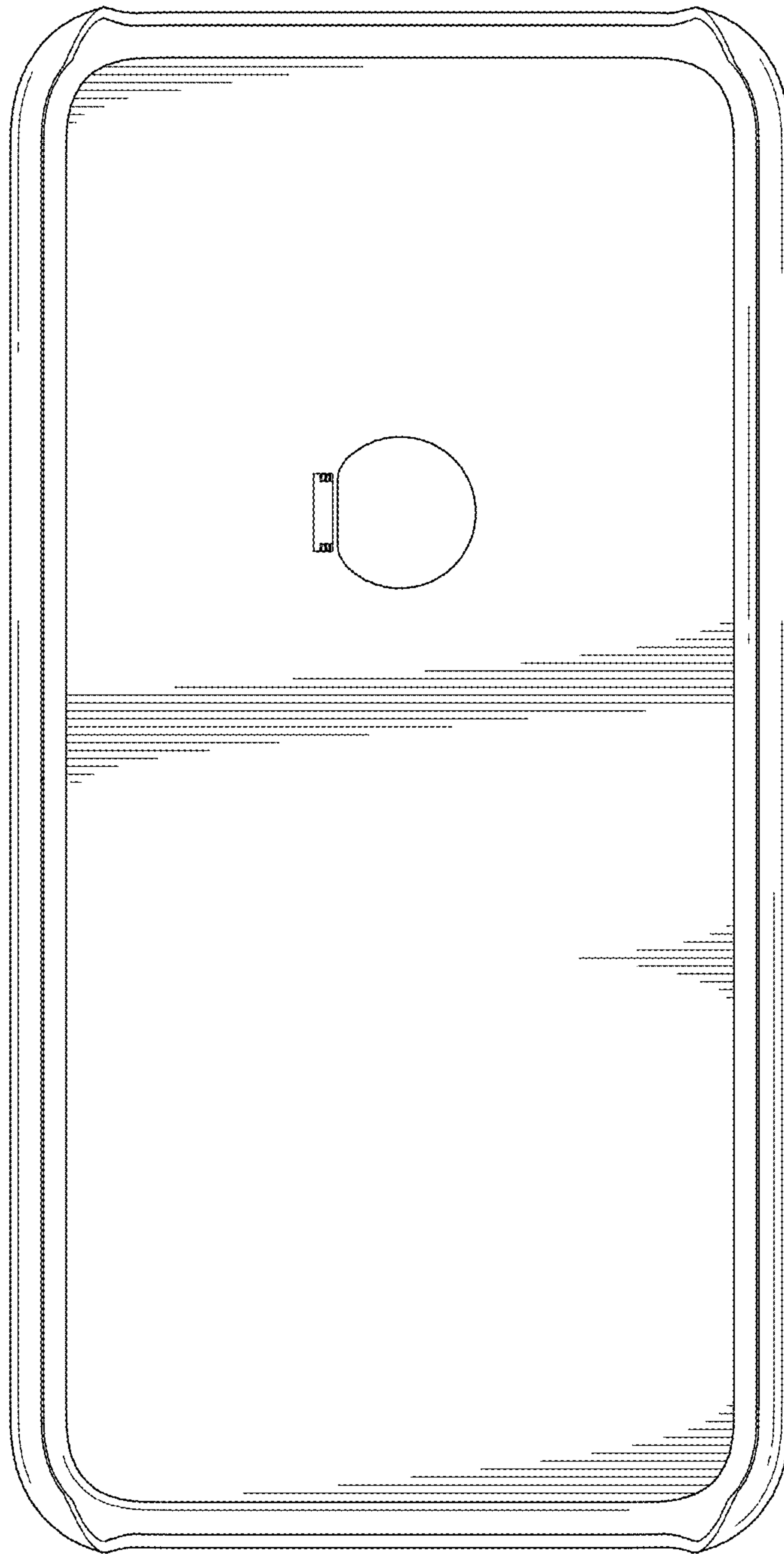

FIG.155

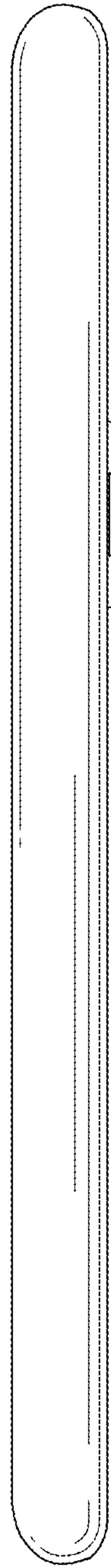

FIG.156

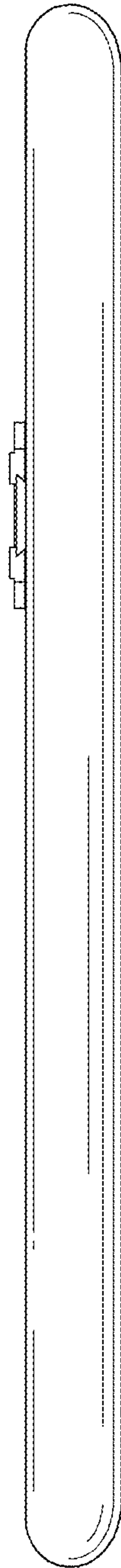

FIG.157

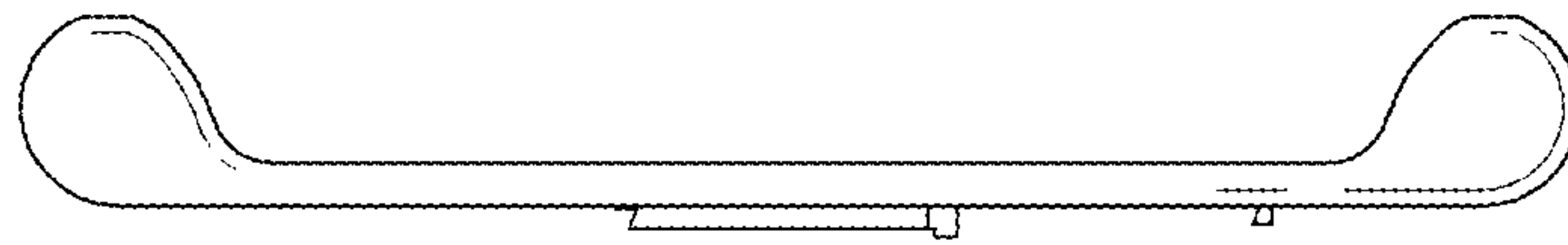

FIG.158

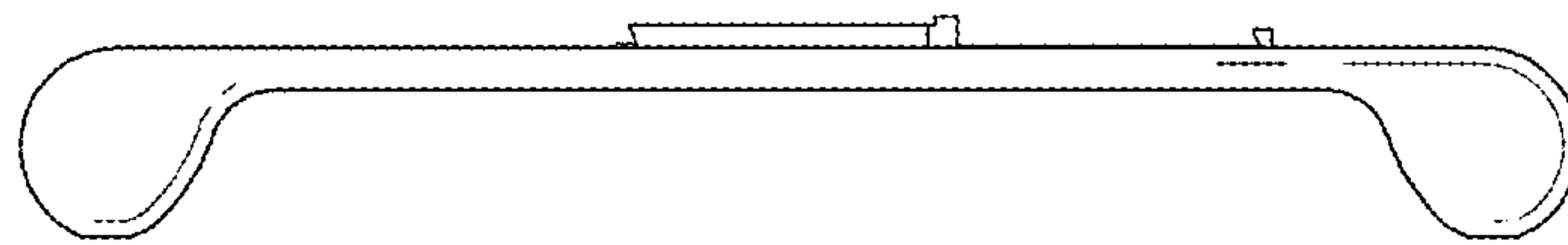

FIG.159

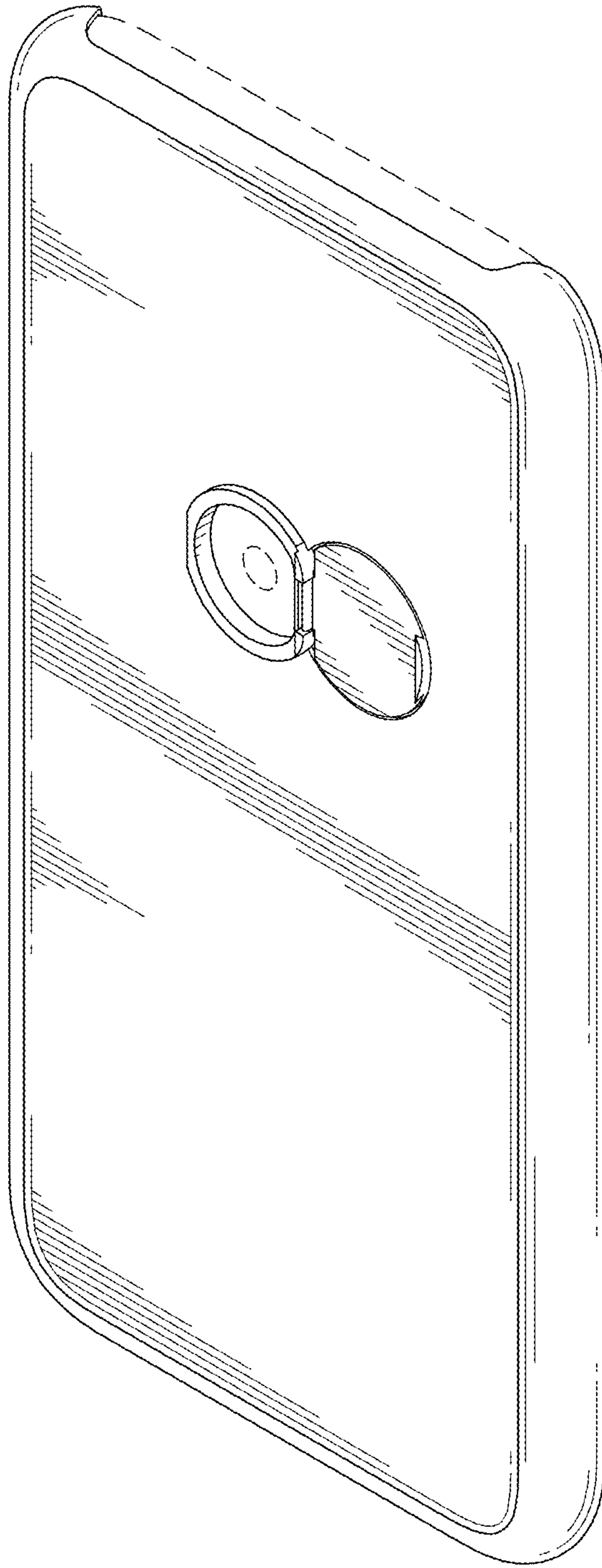

FIG.160