



US00D940103S

(12) **United States Design Patent**
Xing et al.

(10) **Patent No.:** **US D940,103 S**

(45) **Date of Patent:** **** Jan. 4, 2022**

(54) **INTELLIGENT SPEAKER**

FOREIGN PATENT DOCUMENTS

(71) Applicant: **Beijing Xiaomi Mobile Software Co., Ltd.**, Beijing (CN)

CN 304912926 S 11/2018
CN 304957796 S 12/2018

(Continued)

(72) Inventors: **Zheng Xing**, Beijing (CN); **Ningning Li**, Beijing (CN); **Lei Zhang**, Beijing (CN); **Jing Jiang**, Beijing (CN)

OTHER PUBLICATIONS

(73) Assignee: **Beijing Xiaomi Mobile Software Co., Ltd.**, Beijing (CN)

No one is building the smart speaker we actually want, publication date Jun. 22, 2017, [online][site visited Dec. 1, 2020] URL: <https://www.theverge.com/2017/6/22/15850420/smart-speaker-market-sonos-amazon-echo-homepod-google-home> (Year: 2017).*

(Continued)

(**) Term: **15 Years**

(21) Appl. No.: **35/509,001**

Primary Examiner — L. A. Grabenstetter

(22) Filed: **Sep. 24, 2019**

(74) *Attorney, Agent, or Firm* — Syncoda LLC; Feng Ma

(80) **Hague Agreement Data**

(57) **CLAIM**

Int. Filing Date: **Sep. 24, 2019**

The ornamental design for an intelligent speaker, as shown and described.

Int. Reg. No.: **DM/206846**

Int. Reg. Date: **Sep. 24, 2019**

Int. Reg. Pub. Date: **Apr. 10, 2020**

DESCRIPTION

(30) **Foreign Application Priority Data**

Apr. 2, 2019 (CN) 201930144260.X

(51) **LOC (13) Cl.** **14-01**

(52) **U.S. Cl.**
USPC **D14/216**; D14/496

(58) **Field of Classification Search**
USPC D14/172, 188, 194, 203.1, 204, 209.1, D14/211, 212, 214, 215, 216, 221, 496
CPC H04R 2420/07; H04R 5/02; H04R 1/403; H04R 2201/028

See application file for complete search history.

- 1.-2. Intelligent speaker
- 1.1: Front view of the first embodiment of the design
- 1.2: Back view thereof
- 1.3: Left view thereof
- 1.4: Right view thereof
- 1.5: Top view thereof
- 1.6: Bottom view thereof
- 1.7: Perspective view 1 thereof
- 1.8: Perspective view 2 thereof
- 2.1: Front view of the second embodiment of the design
- 2.2: Back view thereof
- 2.3: Left view thereof
- 2.4: Right view thereof
- 2.5: Top view thereof
- 2.6: Bottom view thereof
- 2.7: Perspective view 1 thereof
- 2.8: Perspective view 2 thereof

The broken lines represent portions of the intelligent speaker that form no part of the claimed design.

(56) **References Cited**

U.S. PATENT DOCUMENTS

D691,587 S * 10/2013 Ferber D14/216
D726,143 S * 4/2015 Cheng D14/197

(Continued)

1 Claim, 16 Drawing Sheets

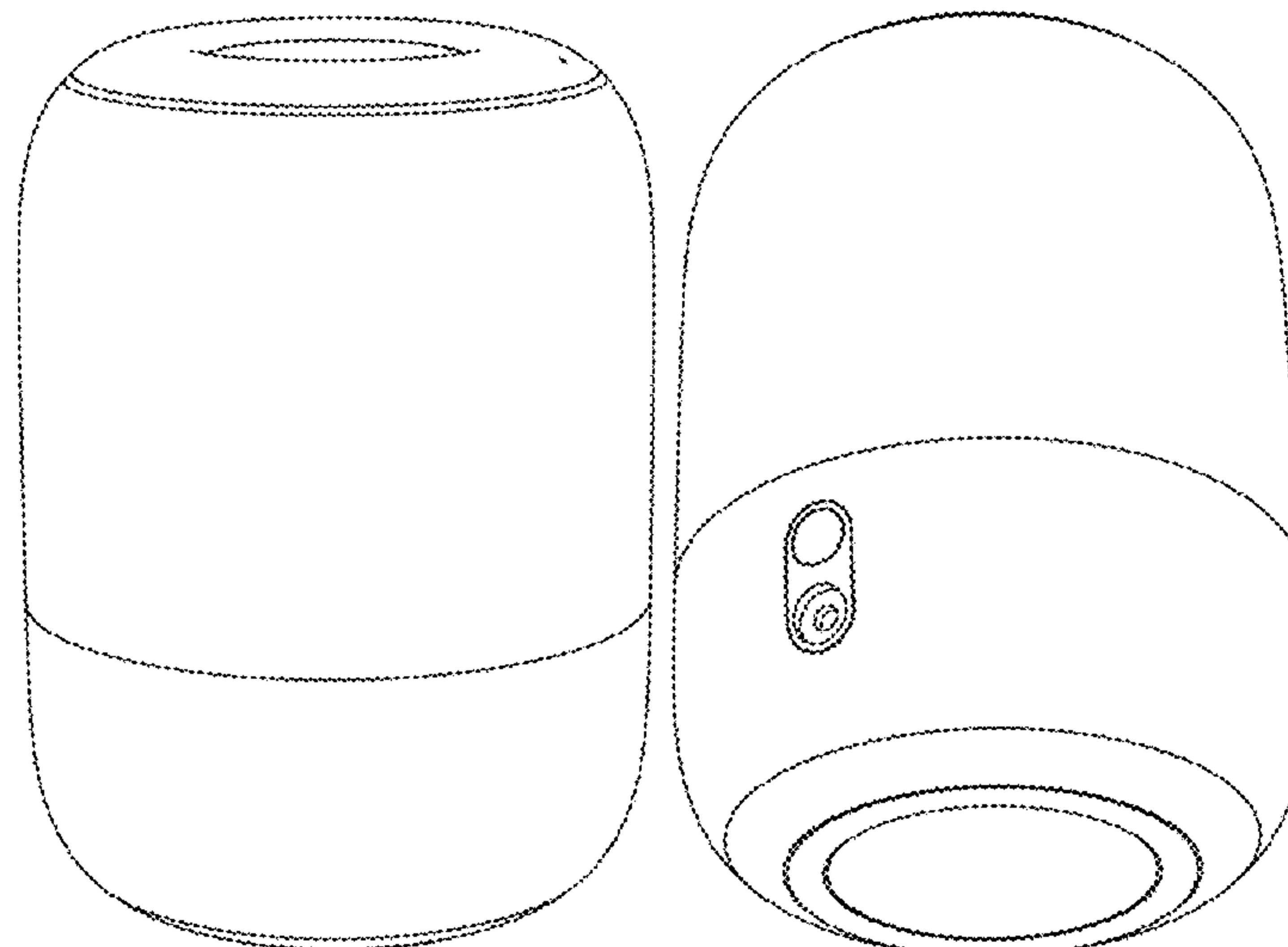

(56)

References Cited

U.S. PATENT DOCUMENTS

D729,772	S	*	5/2015	Ferber	D14/216
D734,740	S	*	7/2015	Erbeus	D14/214
D743,377	S	*	11/2015	Mackiewicz	D14/216
D756,957	S	*	5/2016	Nylen	D14/204
D784,412	S	*	4/2017	Akana	D14/496
D792,374	S	*	7/2017	Kim	D14/204
D800,699	S	*	10/2017	Fischer	D14/216
D809,483	S	*	2/2018	Fischer	D14/216
D810,137	S	*	2/2018	Tsang	D14/496
D812,643	S	*	3/2018	Akana	D14/496
D813,841	S	*	3/2018	Robinson	D14/216
9,967,653	B2	*	5/2018	Huwe	F21V 5/007
D821,359	S	*	6/2018	Tong	D14/216
D836,609	S	*	12/2018	Yoon	D14/216
D838,257	S		1/2019	Manz et al.		
D840,436	S	*	2/2019	Demin	D14/496
D843,418	S	*	3/2019	Demin	D14/496
D843,419	S	*	3/2019	Vaclavik	D14/496
D843,974	S	*	3/2019	Yoon	D14/216
2019/0037307	A1	*	1/2019	Zimmerman	H04R 3/00

FOREIGN PATENT DOCUMENTS

CN	304998186	S	1/2019
CN	305031855	S	2/2019
EM	005825676-0001	S	11/2018

OTHER PUBLICATIONS

The race to make the best smart speaker, publication date Sep. 1, 2017, [online][site visited Dec. 1, 2020] URL: <https://www.which.co.uk/news/2017/09/new-smart-speakers-from-apple-sonos-and-samsung/> (Year: 2017).*

Sony launches its first Google-powered smart speaker, publication date Sep. 1, 2017, [online][site visited Dec. 1, 2020] URL: <https://www.express.co.uk/life-style/science-technology/848234/Sony-smart-speaker-LFS50G-Amazon-Echo-IFA> (Year: 2017).*

Harman Kardon Citation One Review, publication date Dec. 10, 2018, [online][site visited Dec. 1, 2020] URL: <https://www.pcmag.com/reviews/harman-kardon-citation-one> (Year: 2018).*

Homepods Hands-on, publication date Feb. 11, 2018, [online][site visited Dec. 1, 2020] URL: <https://9to5mac.com/2018/02/11/homepod-hands-on-the-best-and-worst-of-apples-new-smart-speaker-video/> (Year: 2018).*

Best smart speaker buying guide, publication date May 14, 2018, [online][site visited Dec. 1, 2020] URL: <https://www.consumerreports.org/cro/smart-speakers/buying-guide/index.htm> (Year: 2018).*

Huawei's new AI speaker sure looks familiar, publication date Oct. 26, 2018, [online][site visited Dec. 1, 2020] URL: <https://www.theverge.com/2018/10/26/18026868/huawei-ai-smart-speaker-apple-homepod> (Year: 2018).*

Harman Kardon Citation One review, publication date Feb. 6, 2019, [online][site visited Dec. 1, 2020] URL: <https://www.androidpolice.com/2019/02/06/harman-kardon-citation-one-review-the-high-end-google-home-youve-been-waiting-for/> (Year: 2019).*

TW Patent Office, Office Action Issued in Application No. 108306052, dated Feb. 17, 2020, 4 pages. (Submitted with Partial Translation).

TW Patent Office, Office Action Issued in Application No. 108306053, dated Feb. 17, 2020, 4 pages. (Submitted with Partial Translation).

State Intellectual Property Office of the People's Republic of China, Office Action and Search Report Issued in Application No. 201930144260X, dated Aug. 30, 2019, 2 pages, (Submitted with Machine Translation).

The International Design System, Office Action Issued in registration No. DM/206846, dated Dec. 16, 2019. 3 pages.

* cited by examiner

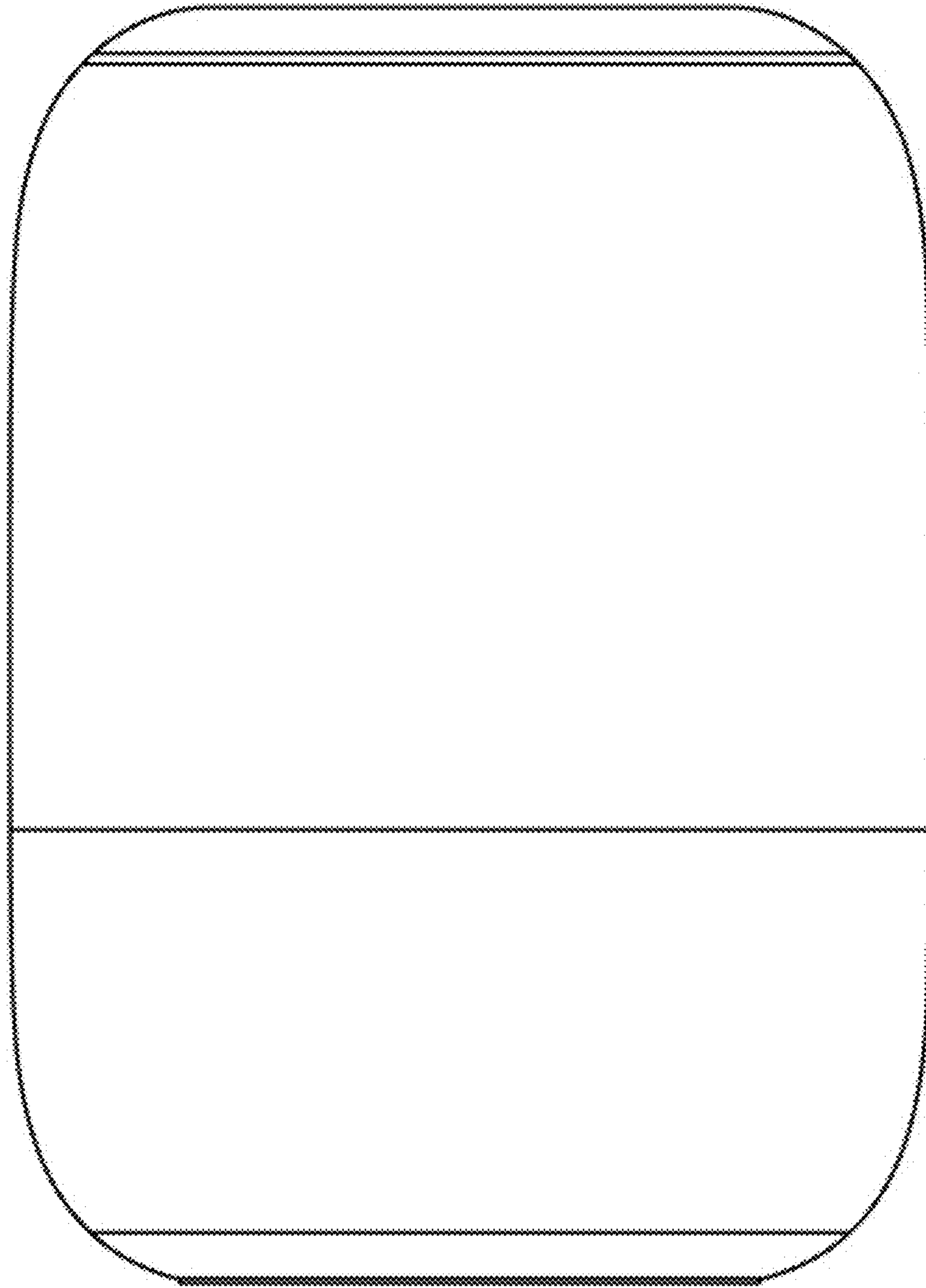

1.1

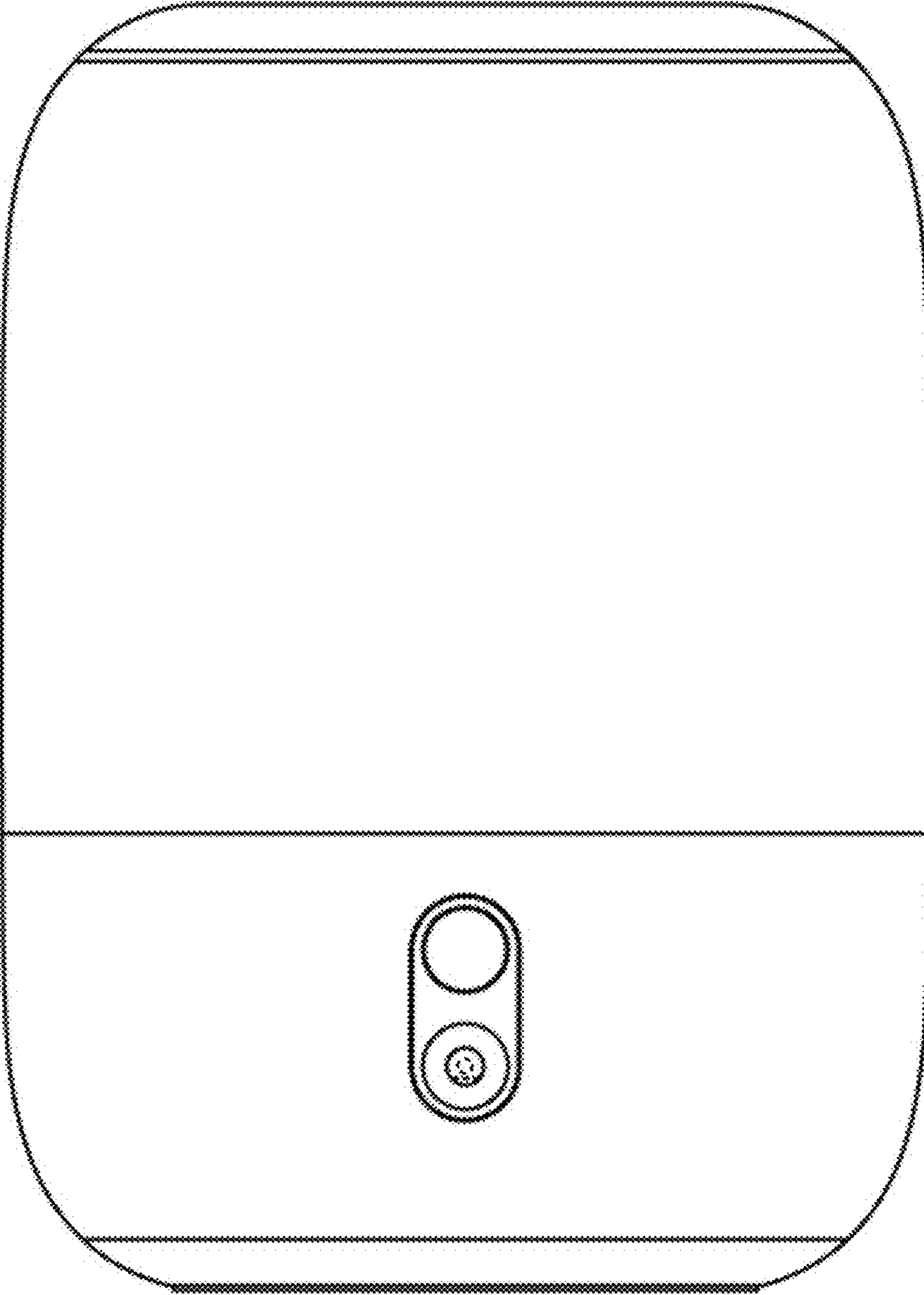

1.2

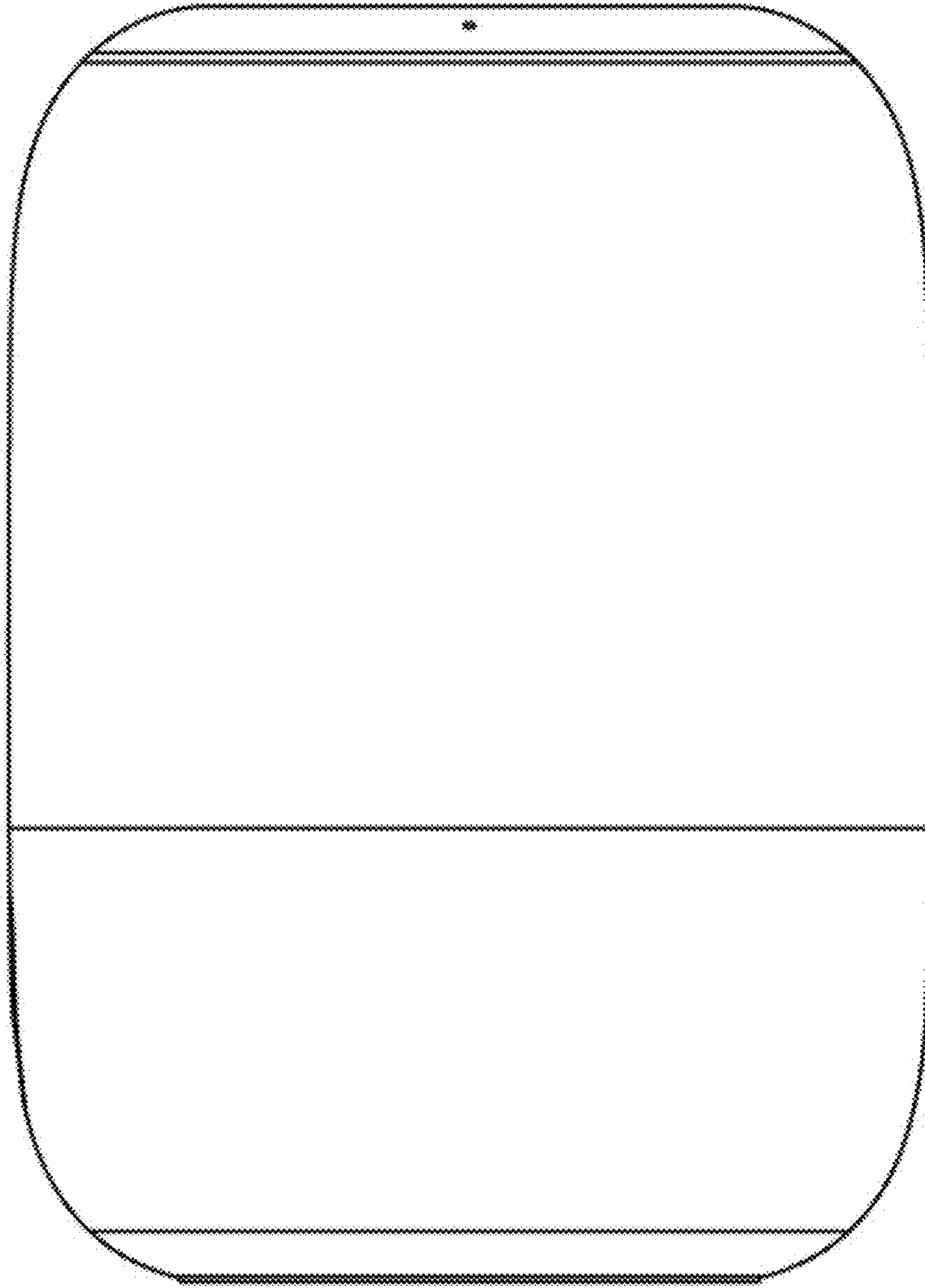

1.3

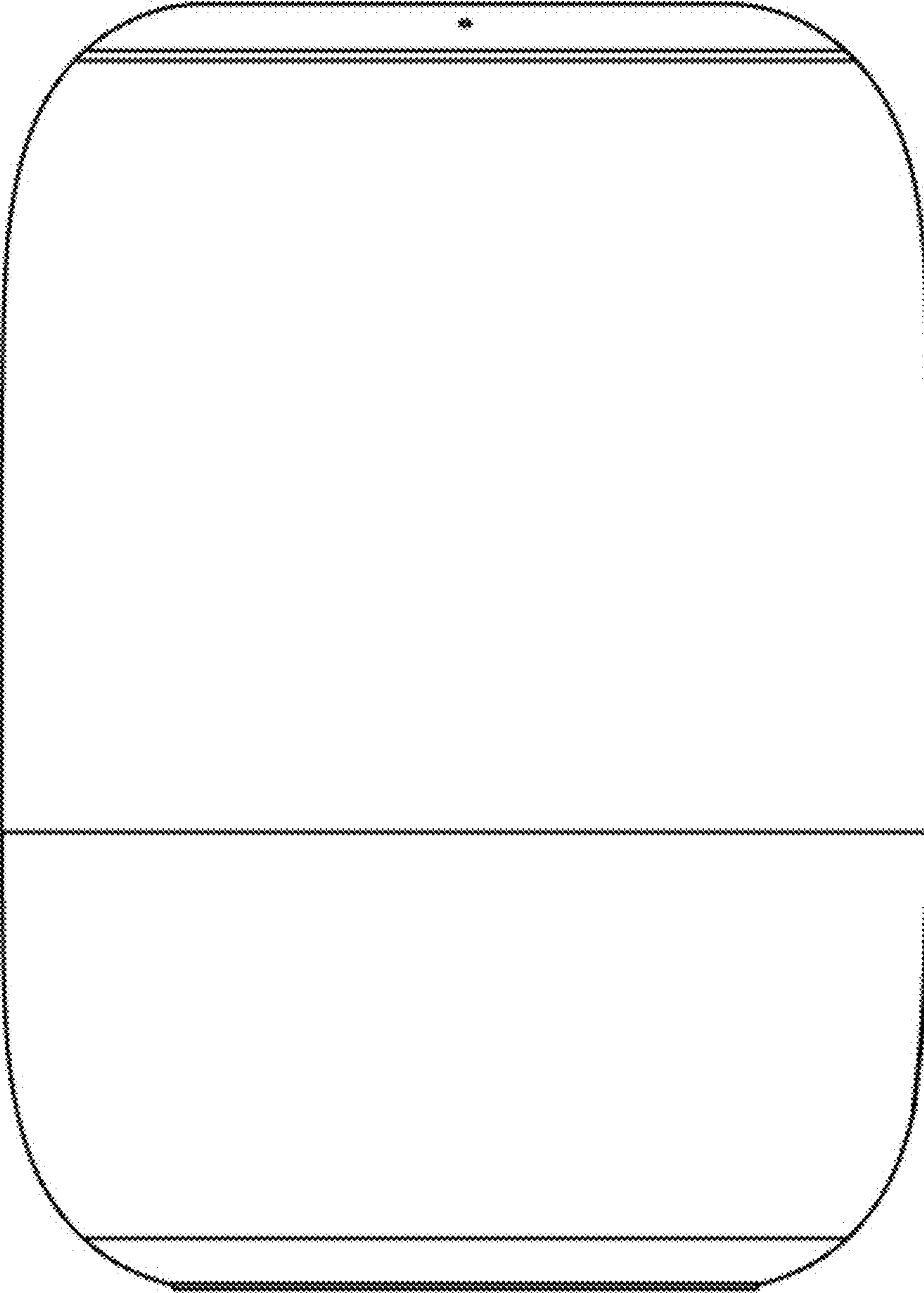

1.4

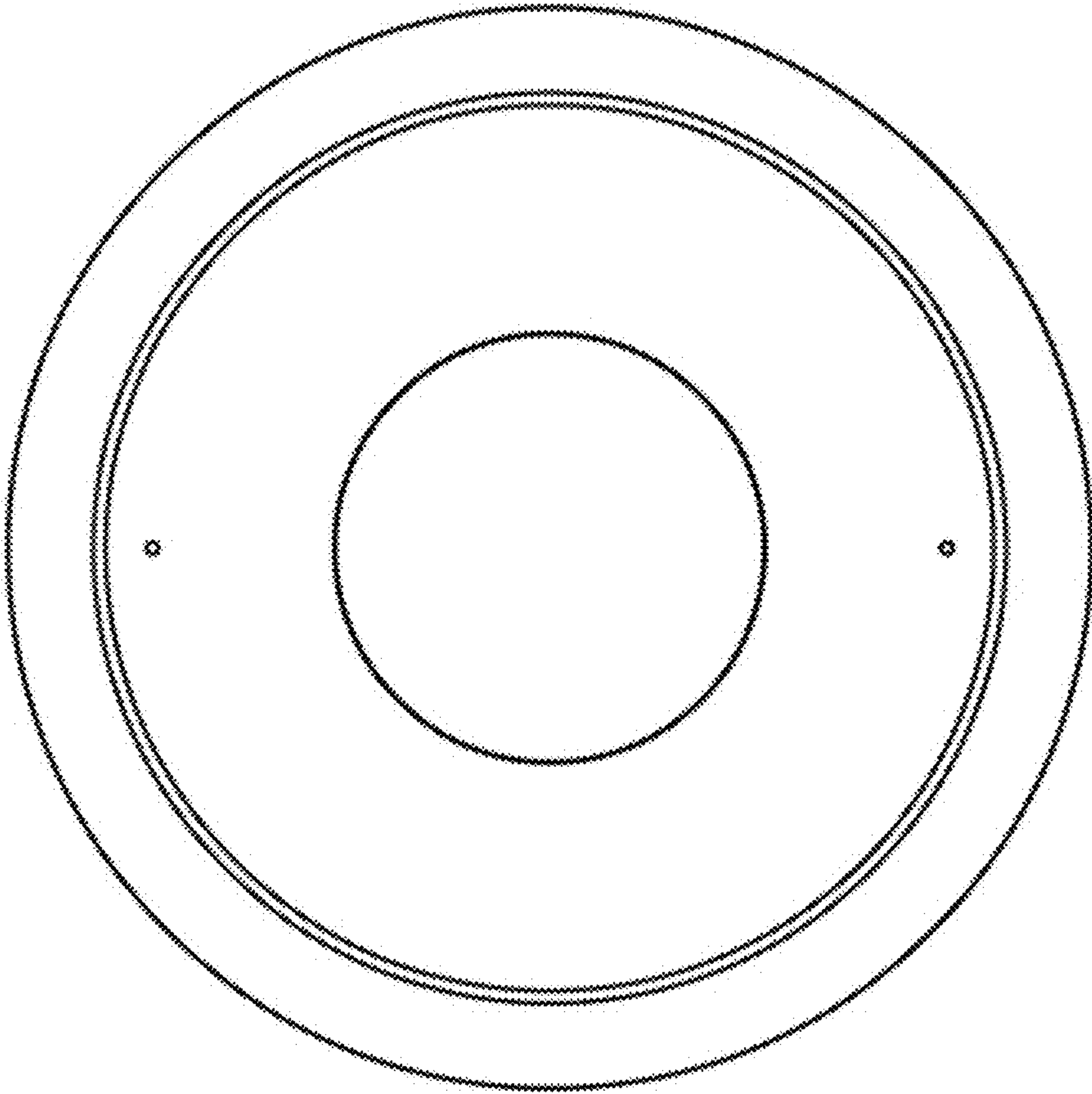

1.5

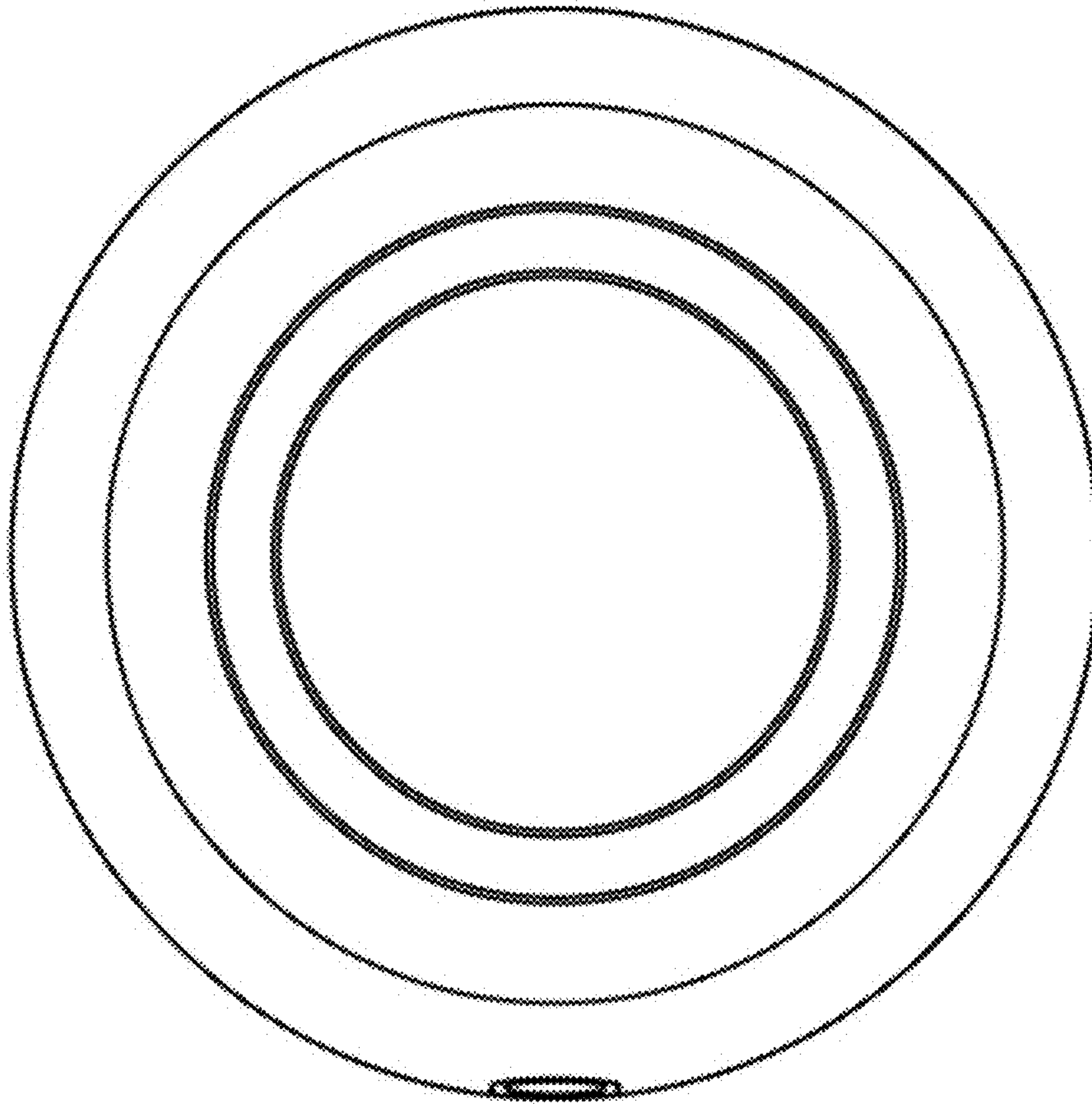

1.6

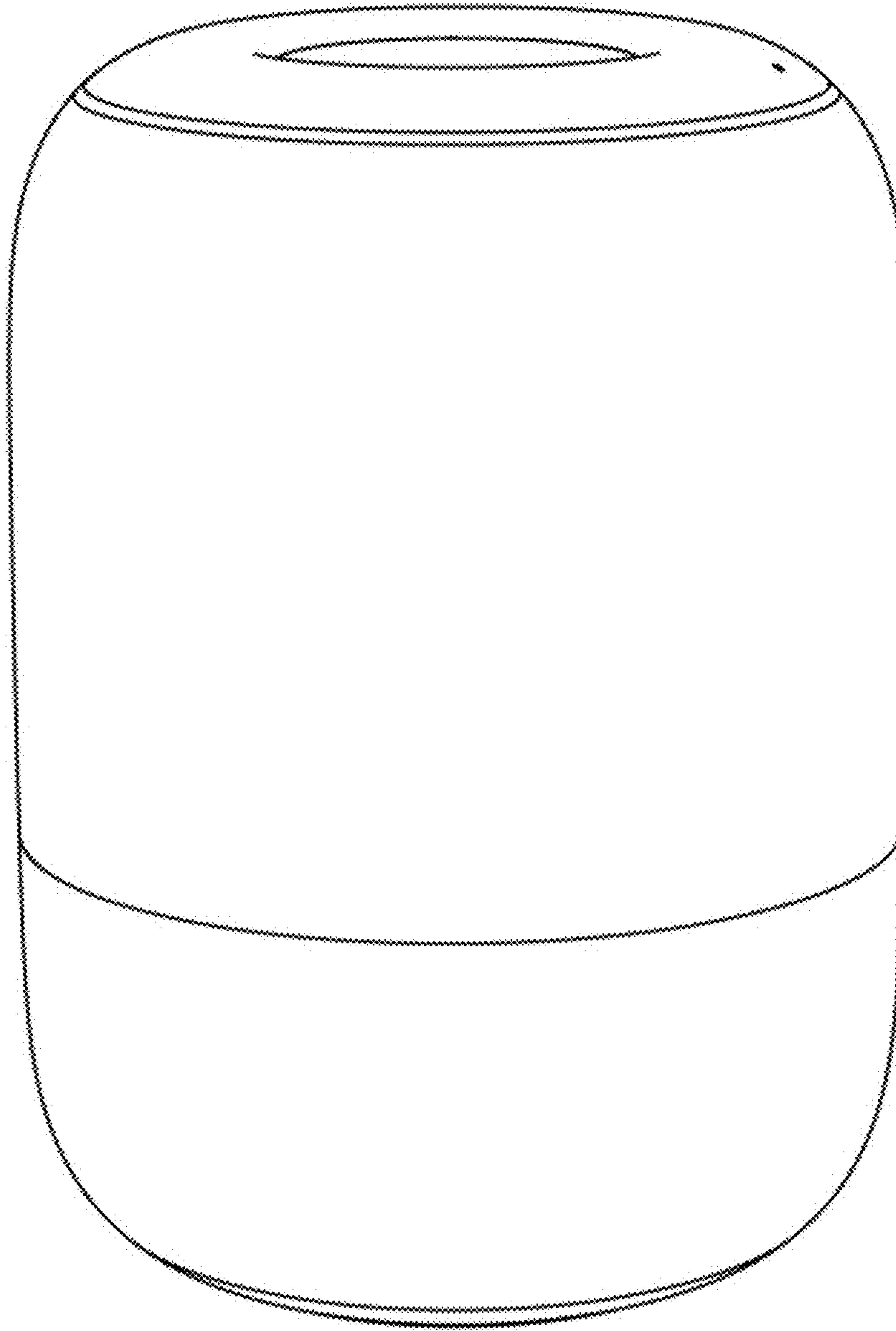

1.7

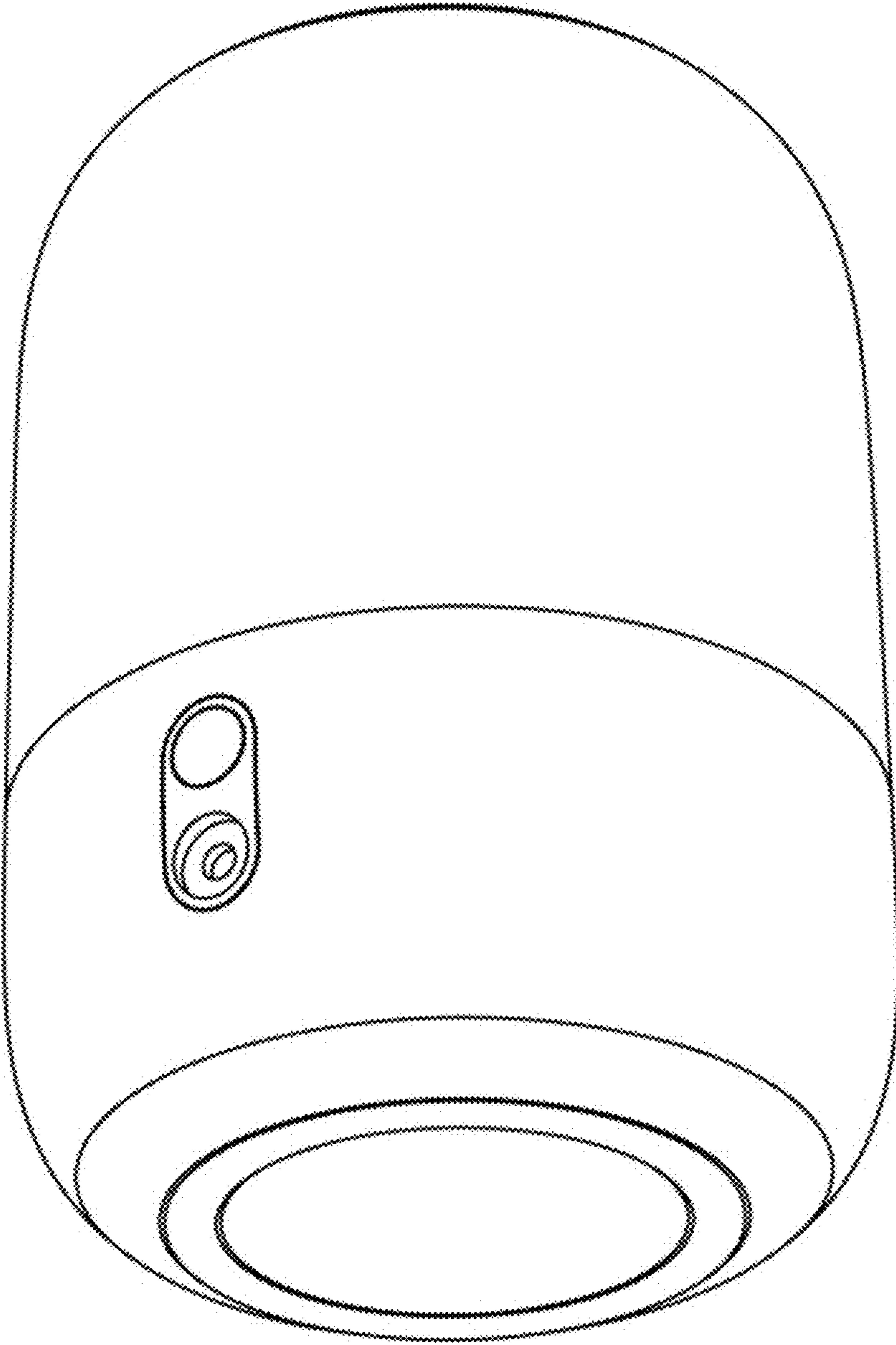

1.8

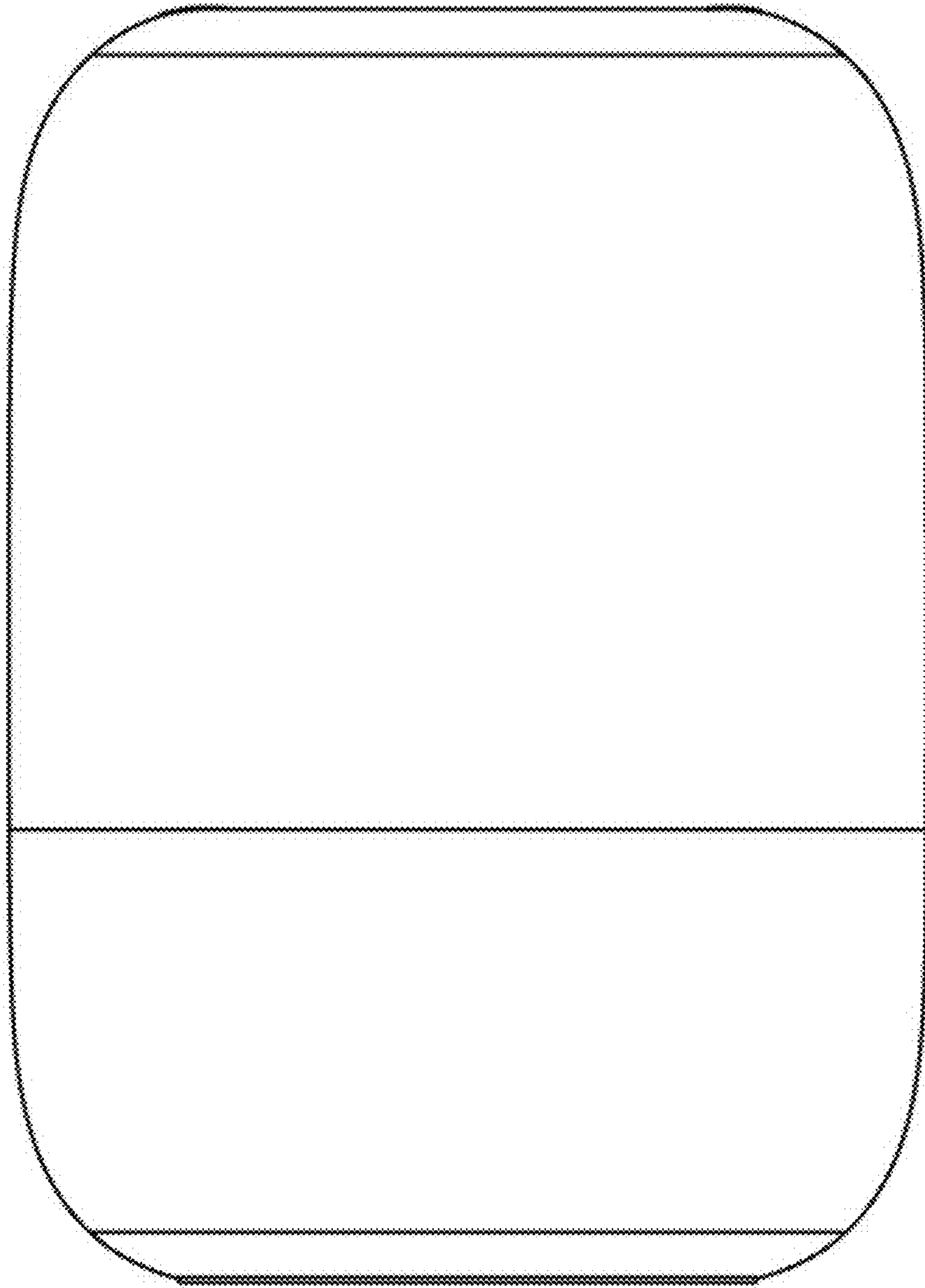

2.1

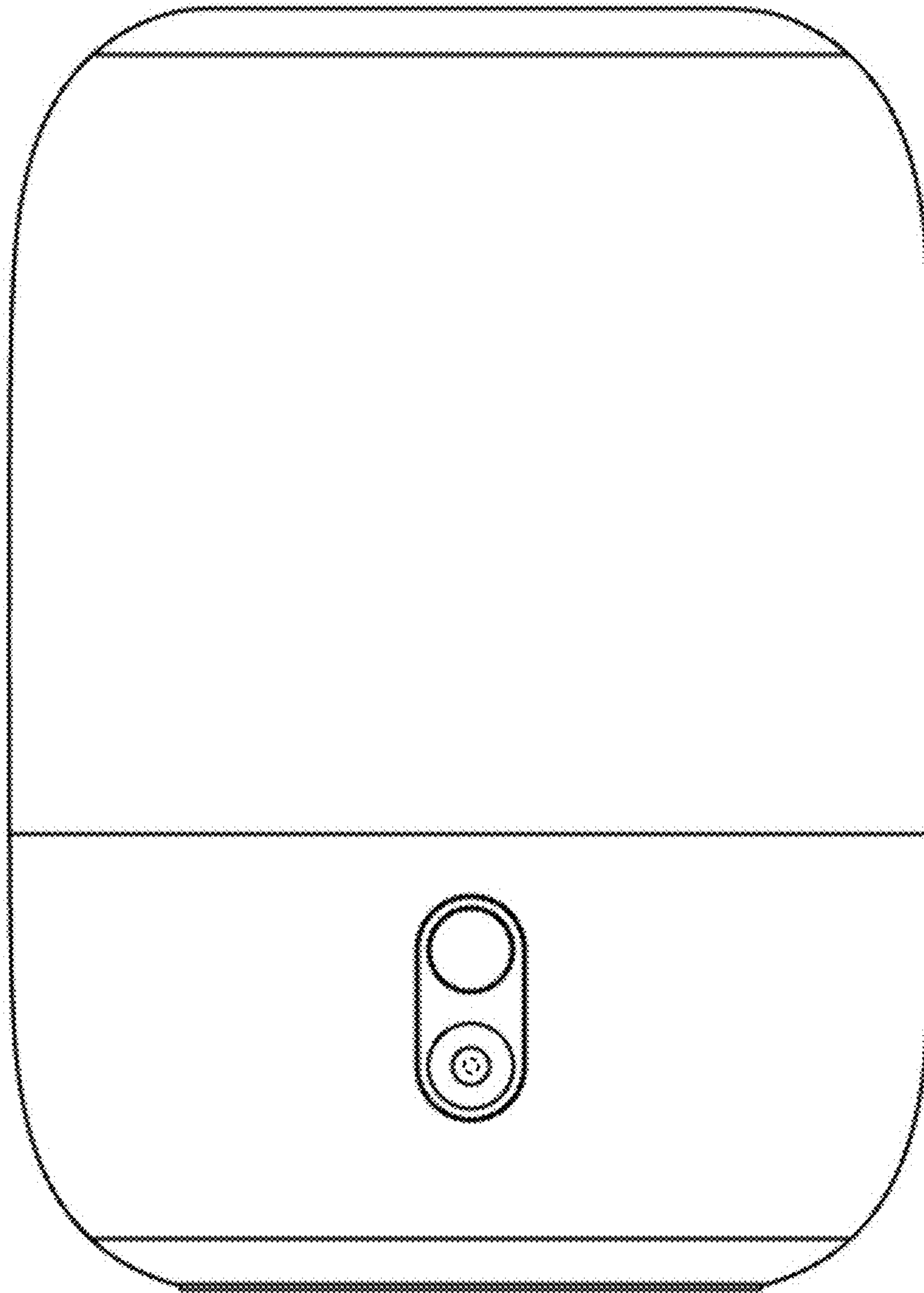

2.2

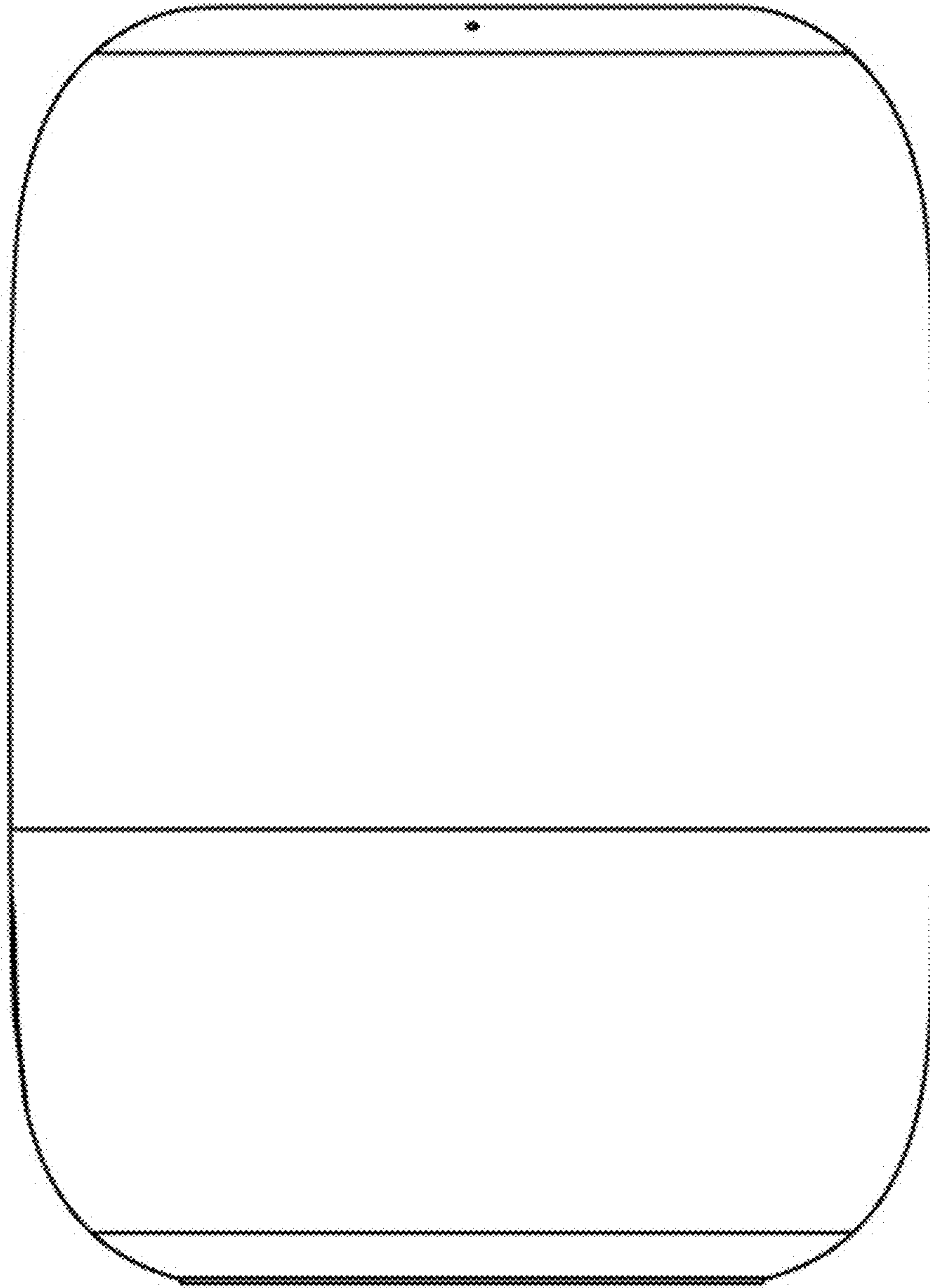

2.3

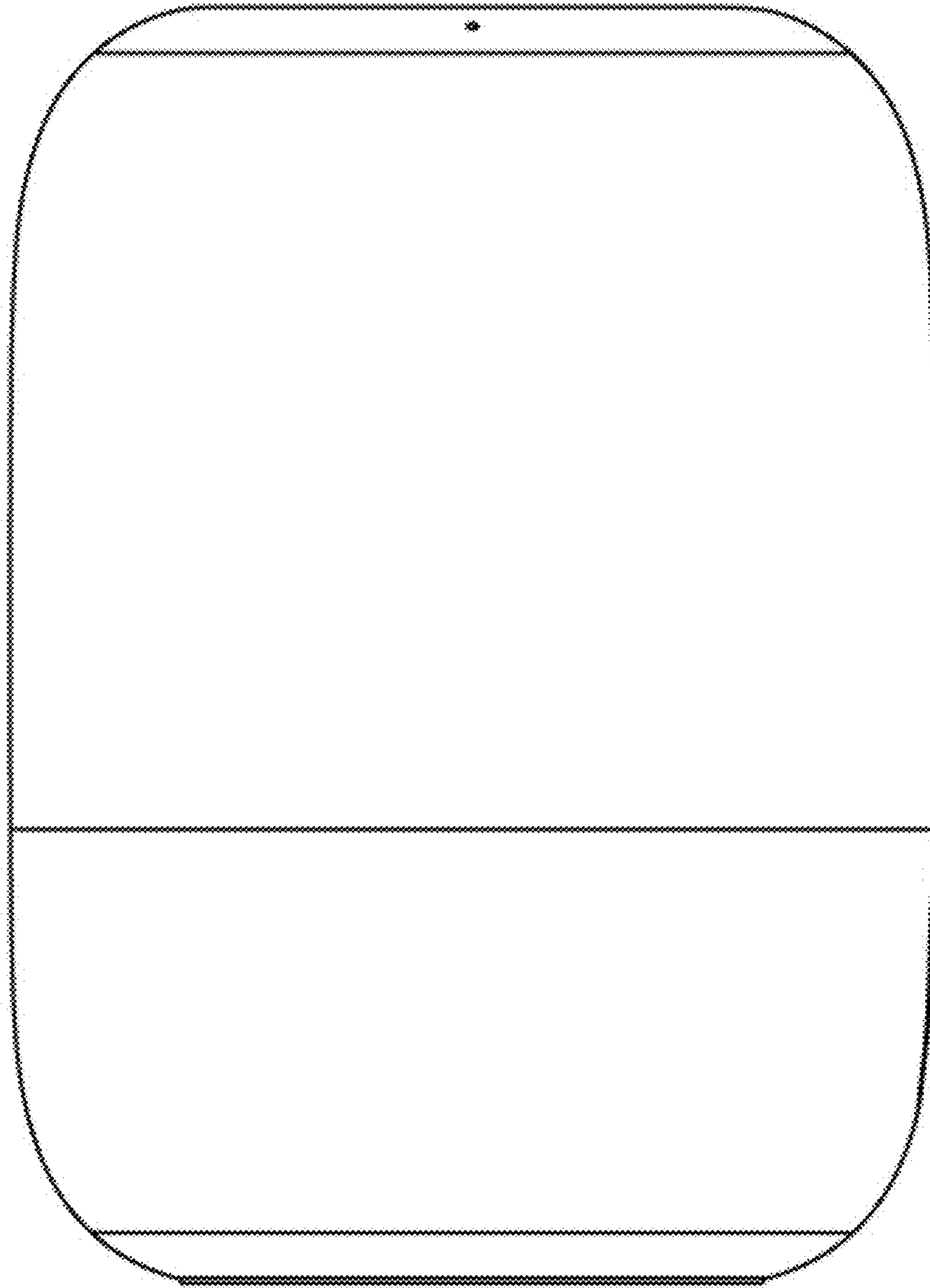

2.4

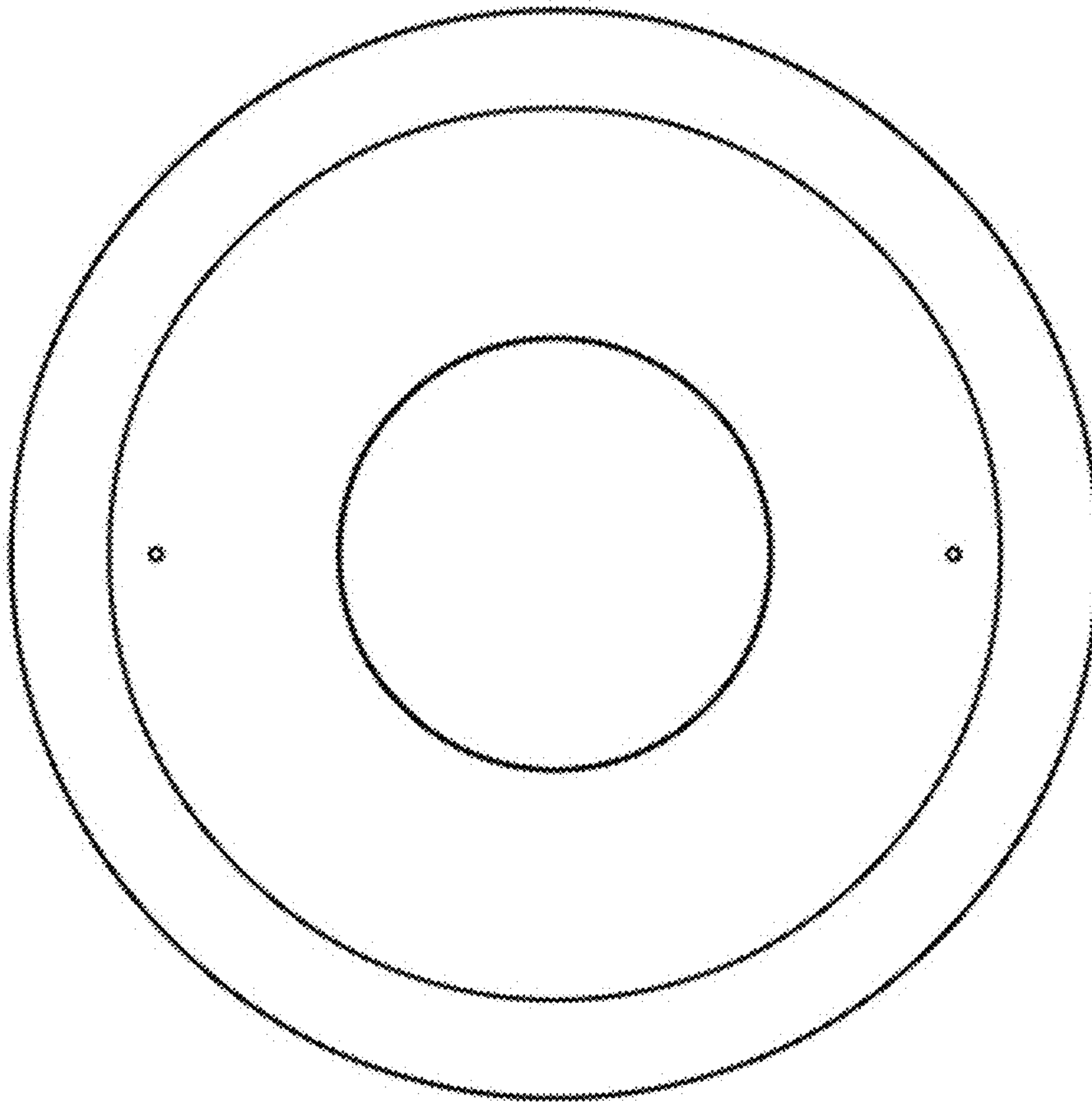

2.5

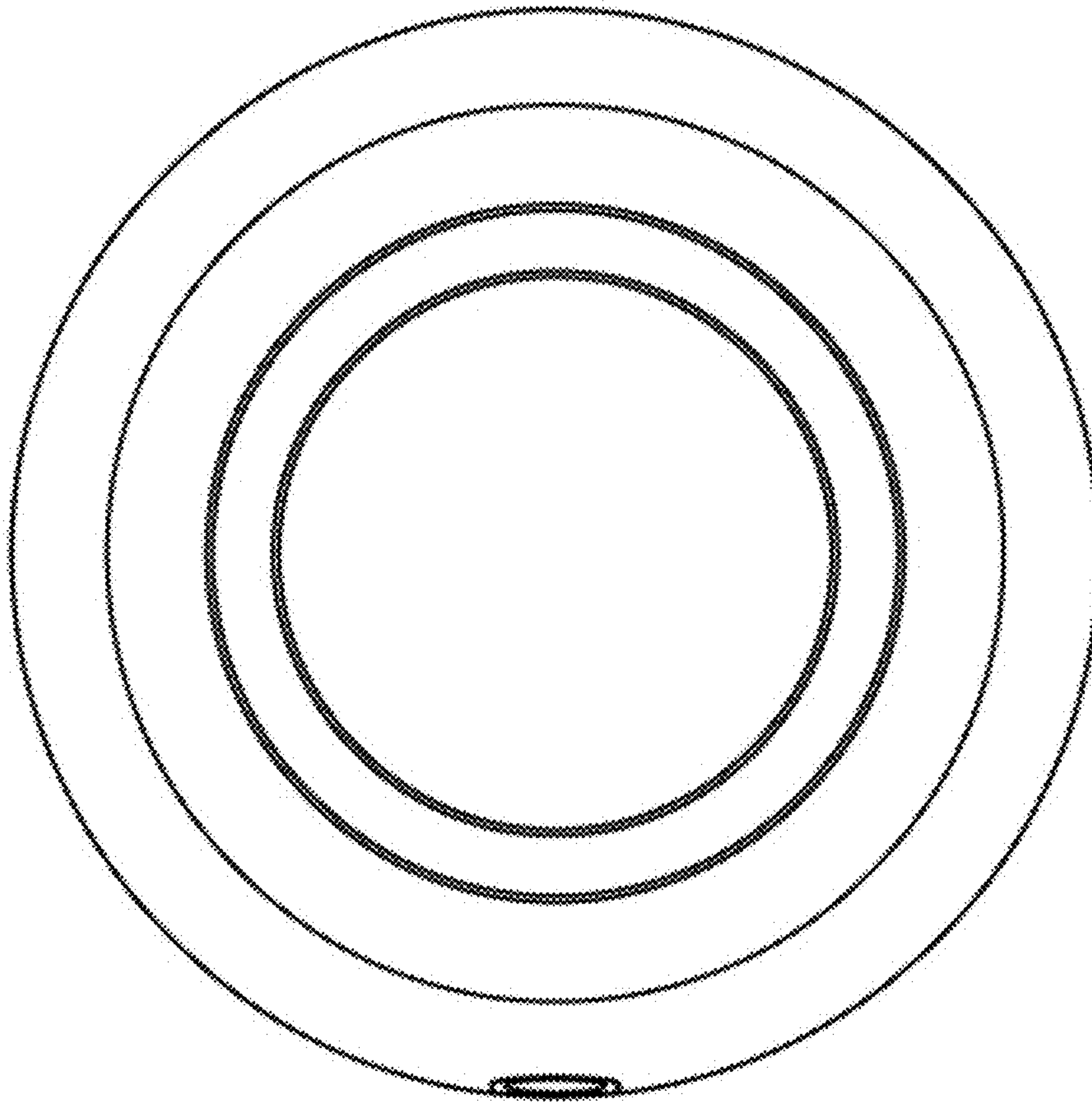

2.6

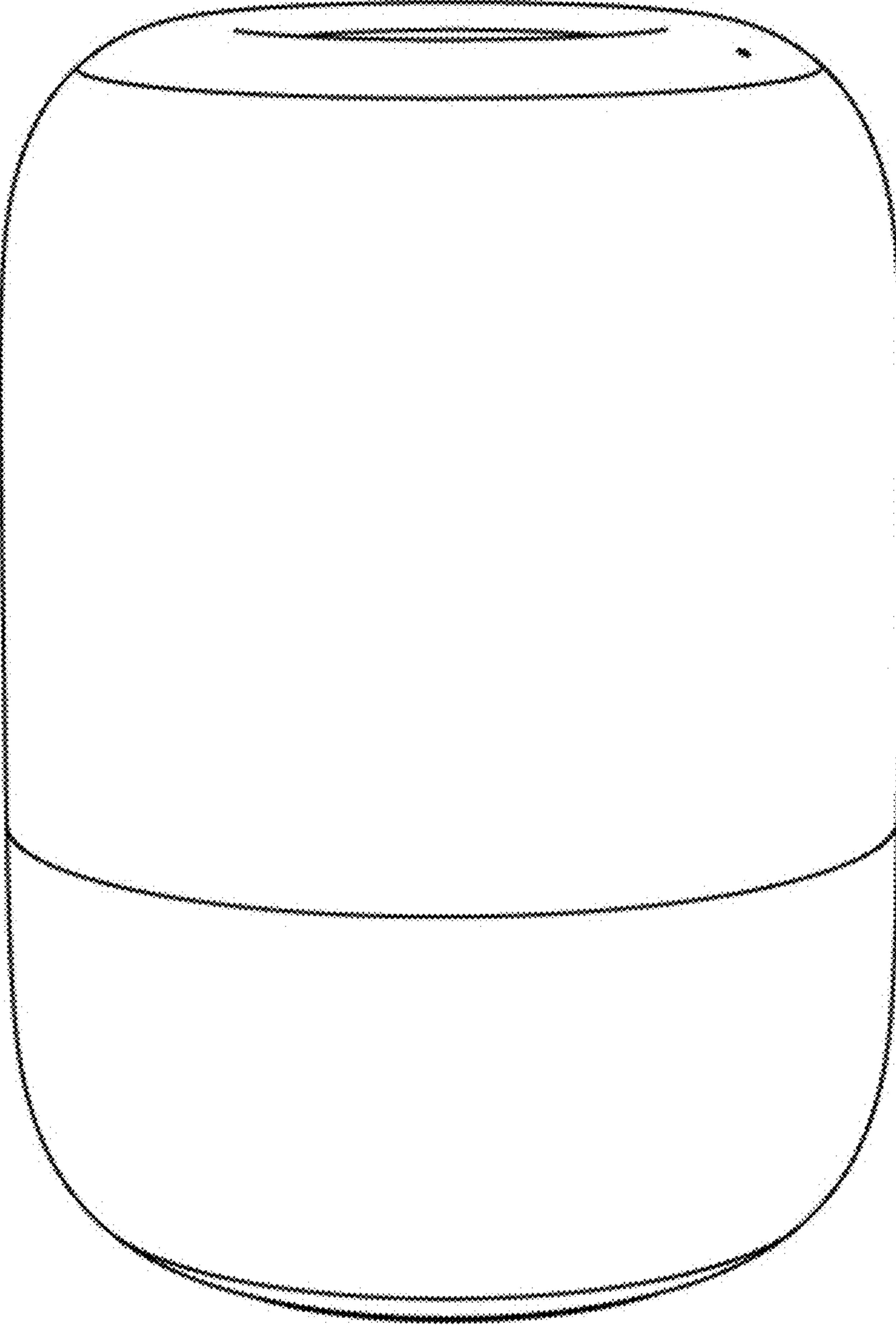

2.7

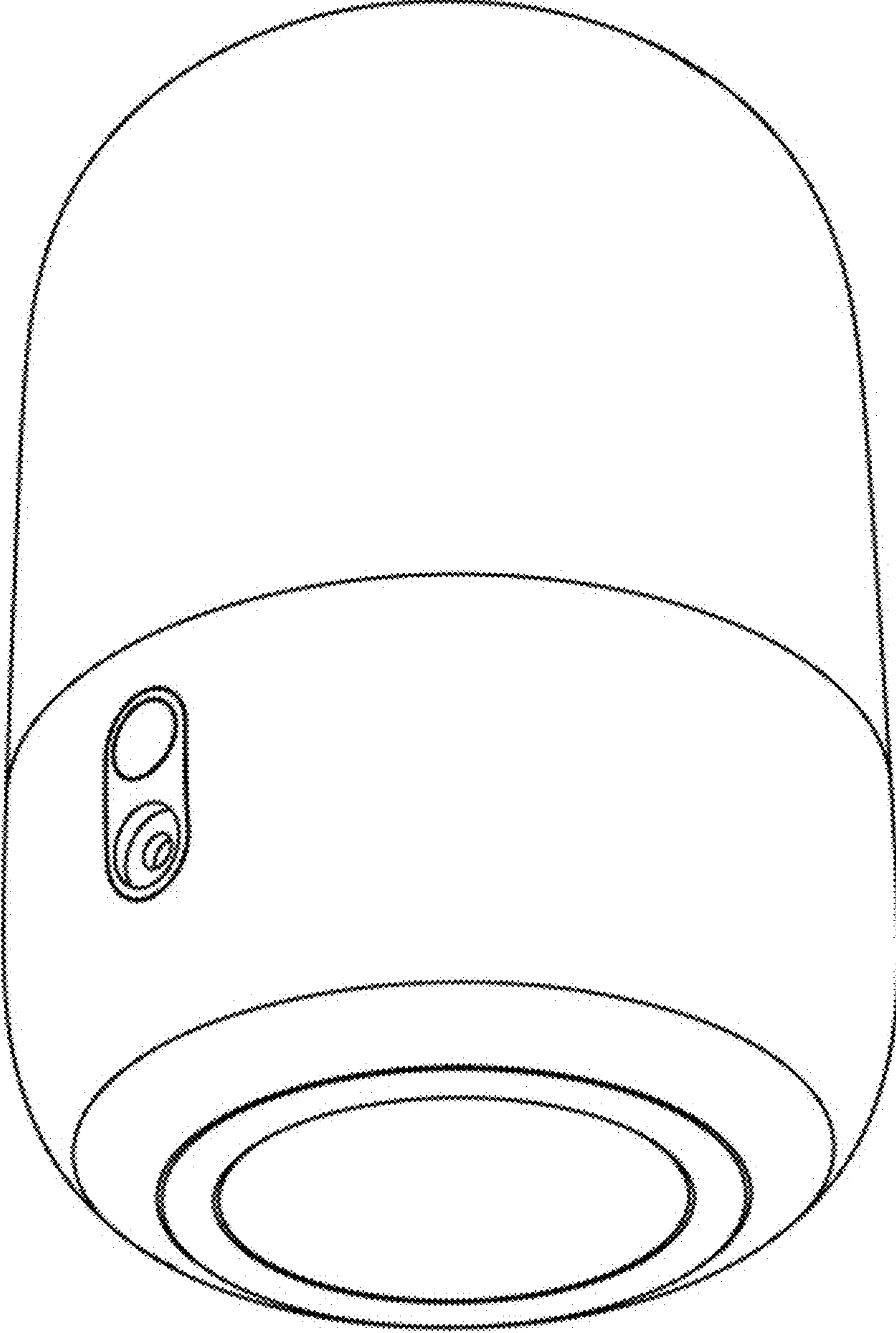

2.8