



US00D940019S

(12) **United States Design Patent**
Kubo et al.

(10) **Patent No.:** **US D940,019 S**
(45) **Date of Patent:** **** Jan. 4, 2022**

(54) **FRONT BUMPER FOR AN AUTOMOBILE**

(71) Applicants: **TOYOTA JIDOSHA KABUSHIKI KAISHA**, Toyota (JP); **SUBARU CORPORATION**, Shibuya-ku (JP)

(72) Inventors: **Kosuke Kubo**, Okazaki (JP); **Koichi Matsumoto**, Toyota (JP); **Kazuhiko Ito**, Toyota (JP)

(73) Assignees: **TOYOTA JIDOSHA KABUSHIKI KAISHA**; **SUBARU CORPORATION**

(**) Term: **15 Years**

(21) Appl. No.: **29/732,351**

(22) Filed: **Apr. 23, 2020**

(30) **Foreign Application Priority Data**

Oct. 25, 2019 (JP) 2019-023770

(51) **LOC (13) Cl.** **12-16**

(52) **U.S. Cl.**
USPC **D12/169**

(58) **Field of Classification Search**
USPC D12/82, 86, 88, 89, 90, 91, 92, 93, 96, D12/163, 164, 165, 166, 167, 169, 170, D12/171, 172, 173, 181, 184, 185, 190, D12/192, 196, 216, 223, 400; D21/533, D21/548, 552, 561
CPC B60R 19/00; B60R 19/02; B60R 19/04; B60R 19/16; B60R 19/18; B60R 19/24; B60R 19/26; B60R 19/44; B60R 19/48; B60R 19/52; B60R 19/56; B60R 2019/007; B60R 2019/522; B60R 2019/527; B60R 2019/1886; B62D 25/02; B62D 25/08; B62D 25/16
See application file for complete search history.

(56) **References Cited**

U.S. PATENT DOCUMENTS

D600,607 S * 9/2009 Lamm D12/169
D609,613 S * 2/2010 Okue D12/169

D619,514 S * 7/2010 Syouji D12/169
D619,515 S * 7/2010 Matsumoto D12/169
D625,230 S * 10/2010 Hirai D12/169
D640,614 S * 6/2011 Kumai D12/169
D640,958 S * 7/2011 Yokoi D12/169
D680,472 S * 4/2013 Kido D12/163
D695,654 S * 12/2013 Kobayashi D12/169
D696,167 S * 12/2013 Ito D12/169
D701,802 S * 4/2014 Campbell D12/169
D733,621 S * 7/2015 Ikuma D12/169

(Continued)

OTHER PUBLICATIONS

Next-Gen Toyota 86 Front End, Published Jan. 20, 2021 [online], [retrieved on Aug. 12, 2021]. Retrieved from the Internet: <https://www.motor1.com/news/467411/toyota-86-bumper-design-trademark/> (Year: 2021).*

(Continued)

Primary Examiner — Christian P. McLean
Assistant Examiner — Adam C Mager
(74) *Attorney, Agent, or Firm* — Saidman DesignLaw Group, LLC

(57) **CLAIM**

The ornamental design for a front bumper for an automobile, as shown and described.

DESCRIPTION

FIG. 1 is a perspective view of a front bumper for an automobile showing our new design; FIG. 2 is a front view thereof; FIG. 3 is a rear view thereof; FIG. 4 is a right side view thereof; FIG. 5 is a left side view thereof; FIG. 6 is a top view thereof; and, FIG. 7 is a bottom view thereof.

1 Claim, 7 Drawing Sheets

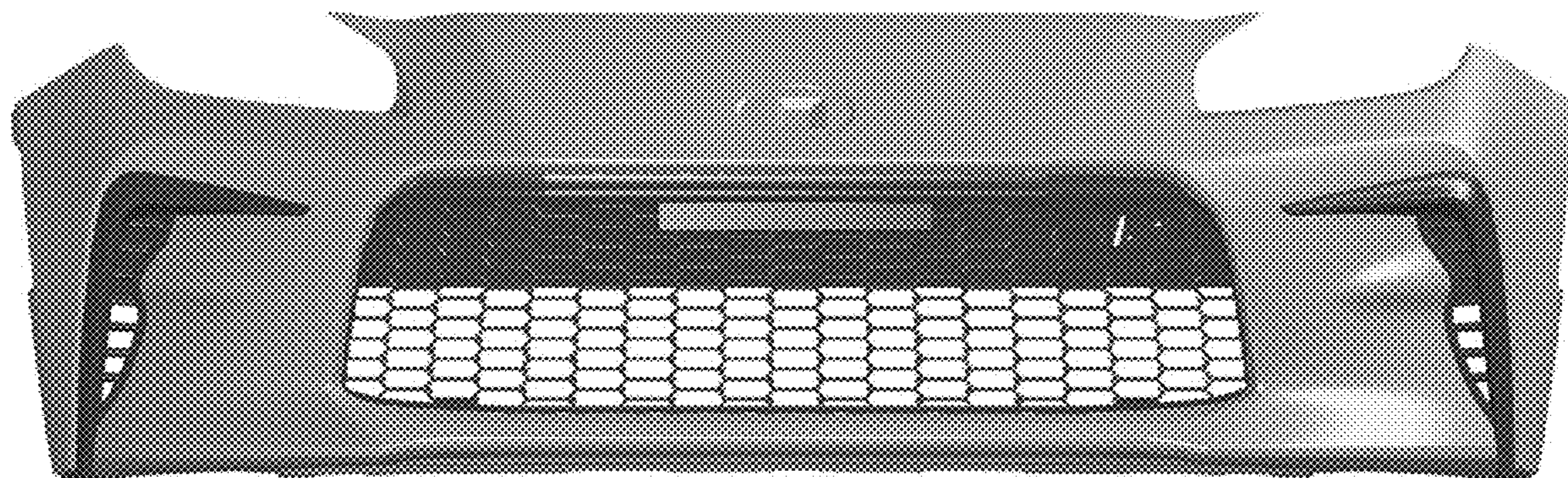

(56)

References Cited

U.S. PATENT DOCUMENTS

D830,250 S * 10/2018 Tomita D12/169
D850,990 S * 6/2019 Metros D12/169
D899,978 S * 10/2020 Metros D12/169
D921,545 S * 6/2021 Fuchino D12/169

OTHER PUBLICATIONS

2022 Toyota GR 86, Published Apr. 5, 2021 [online], [retrieved on Aug. 12, 2021]. Retrieved from the Internet: <https://www.caranddriver.com/news/a36023984/2022-toyota-gr-86-revealed/> (Year: 2021).
* Toyota Jidosha Kabushiki Kaisha, Toyota Prius PHV GR Sport (2019), Catalogue of Prius PHV, Oct. 1, 2019.
netcarshow.com Jaguar F-Type SVR (2018), <<https://www.netcarshow.com/jaguar/2018-f-type/>>, available as early as Sep. 4, 2019.

* cited by examiner

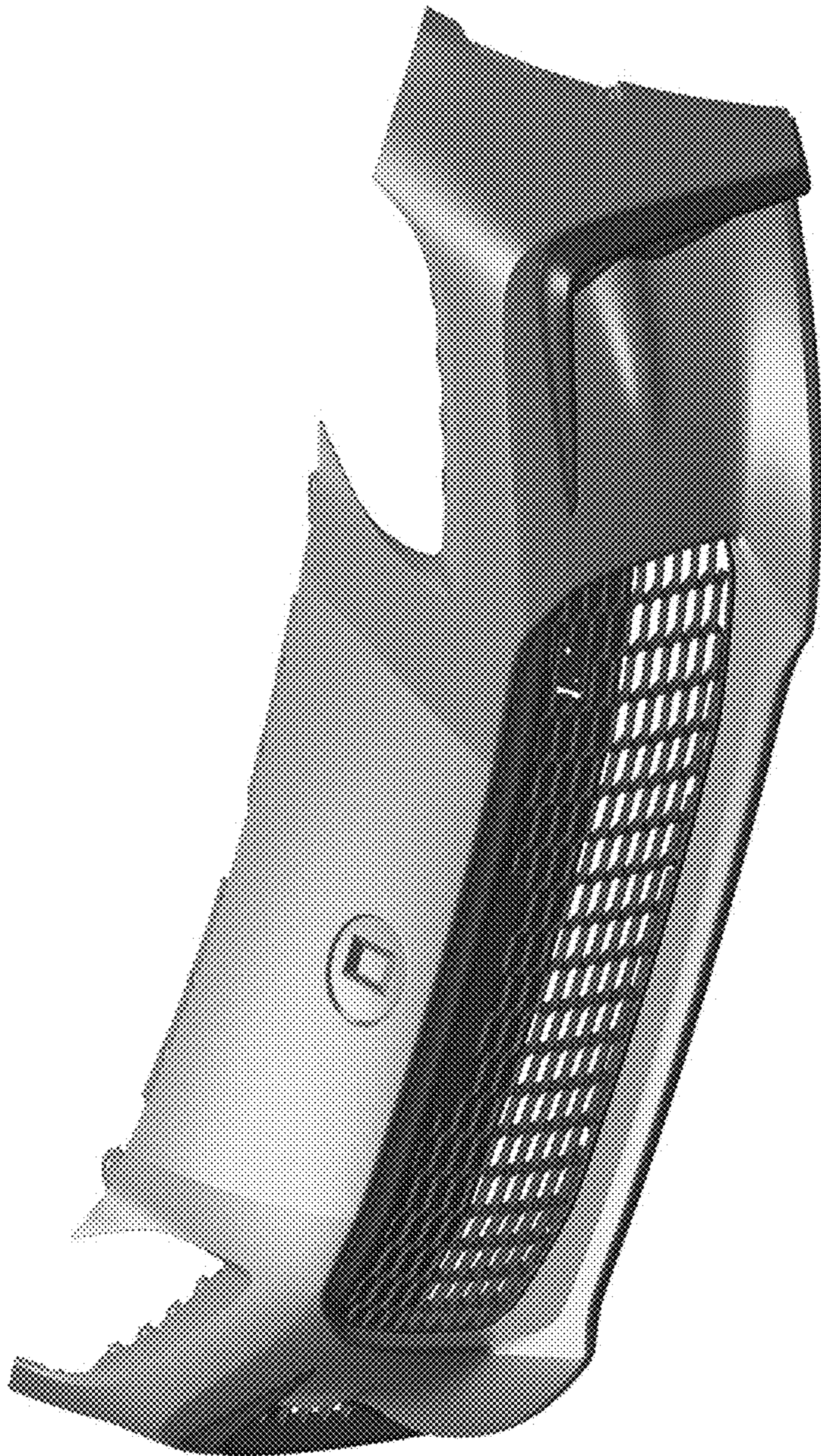

FIG. 1

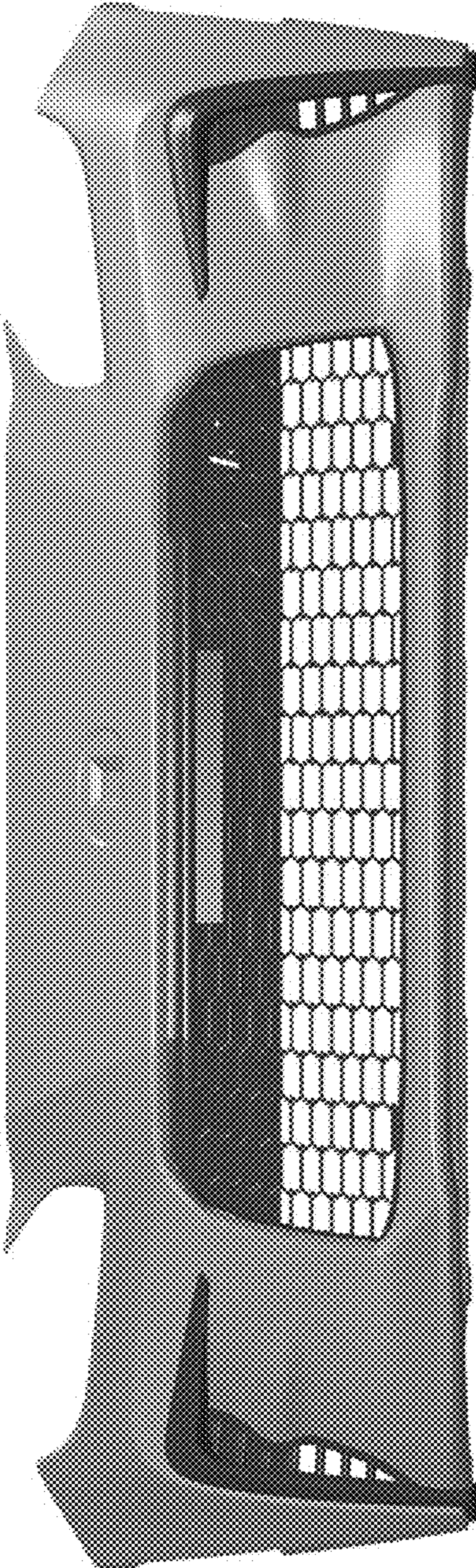

FIG. 2

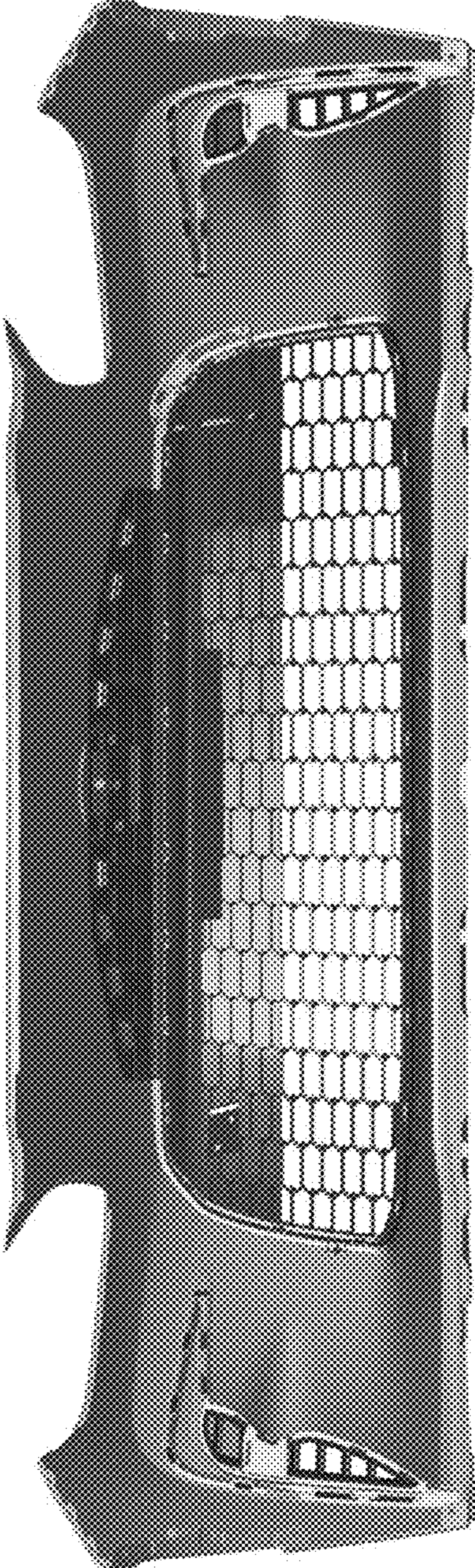

FIG. 3

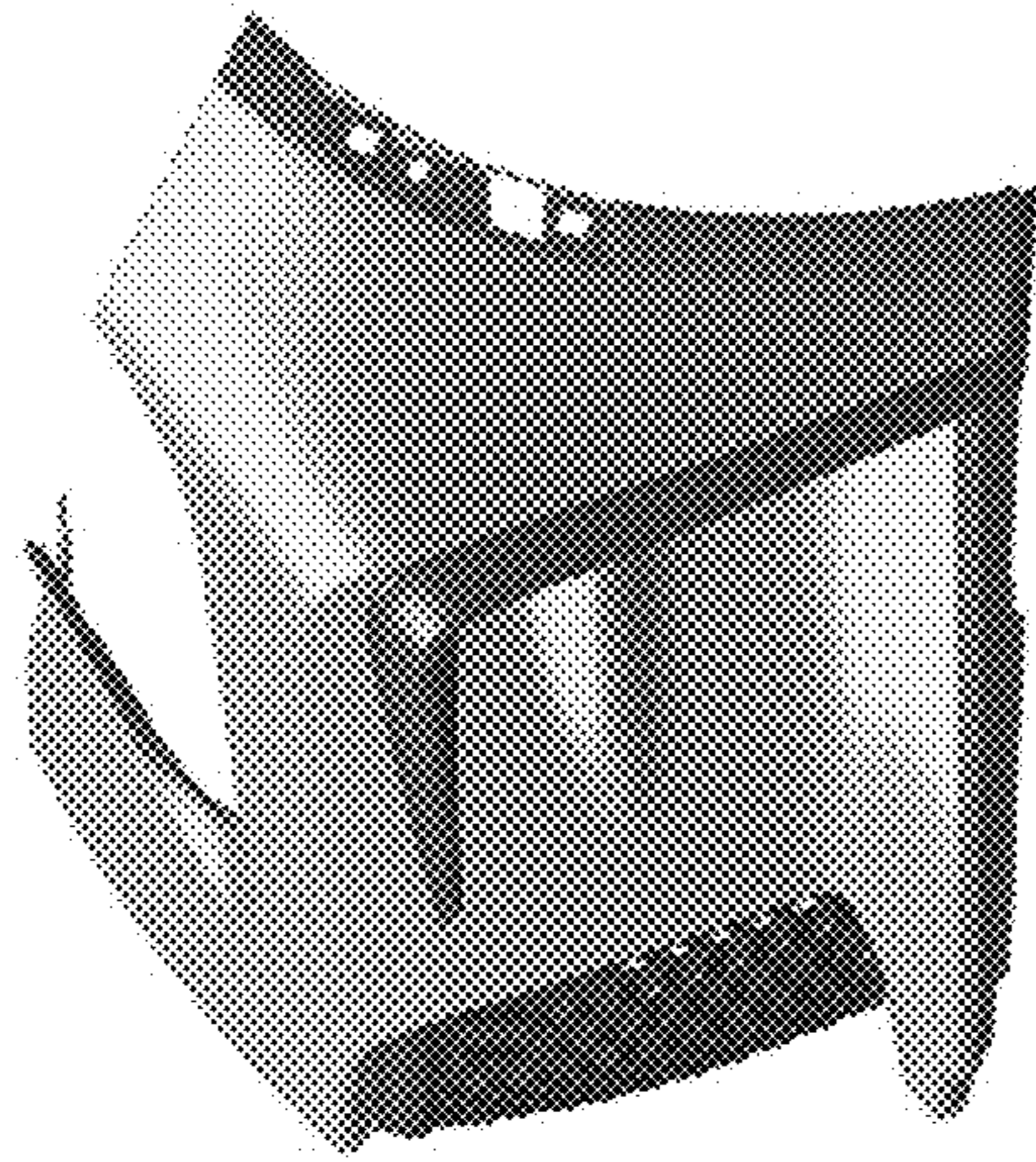

FIG. 4

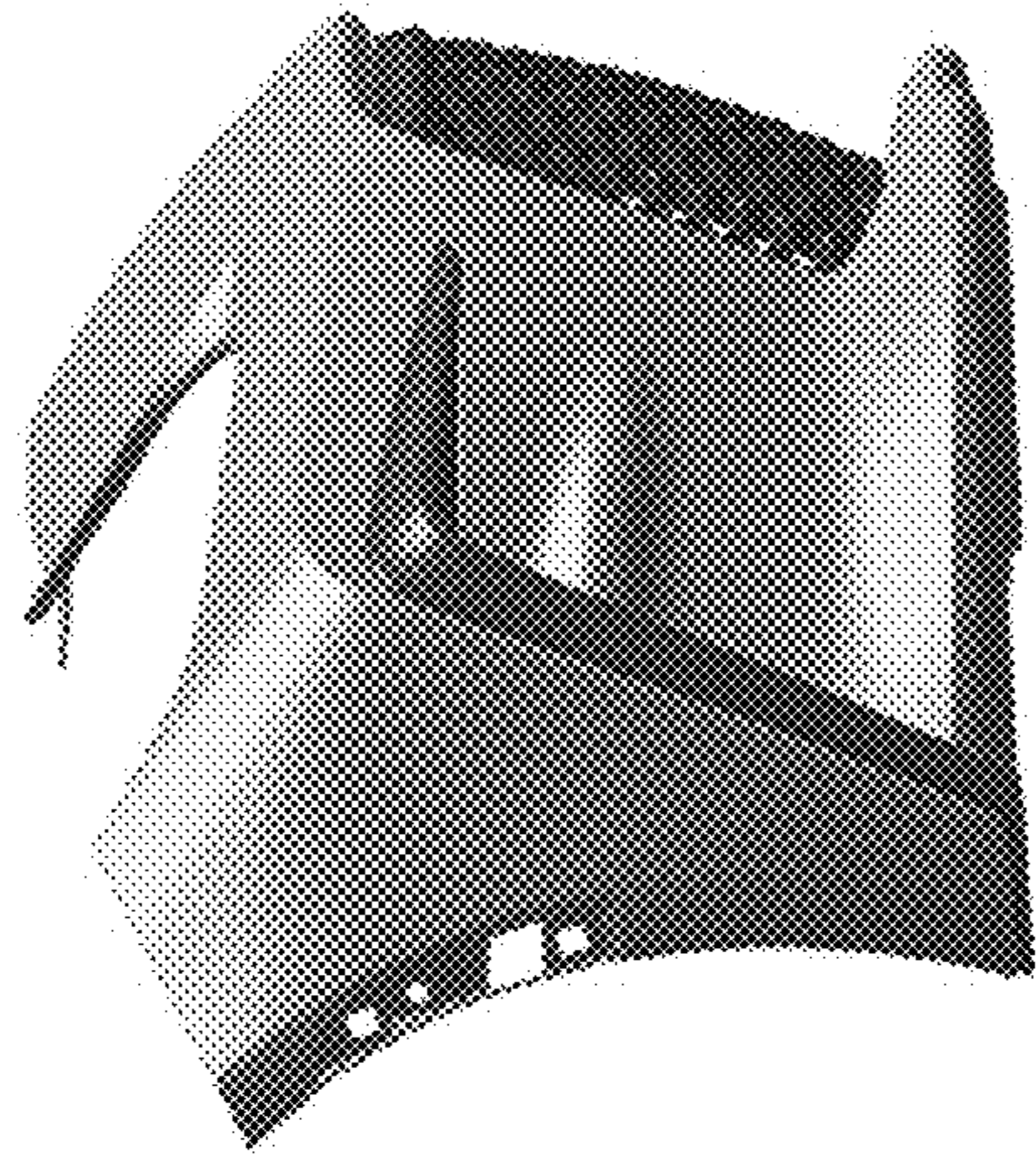

FIG. 5

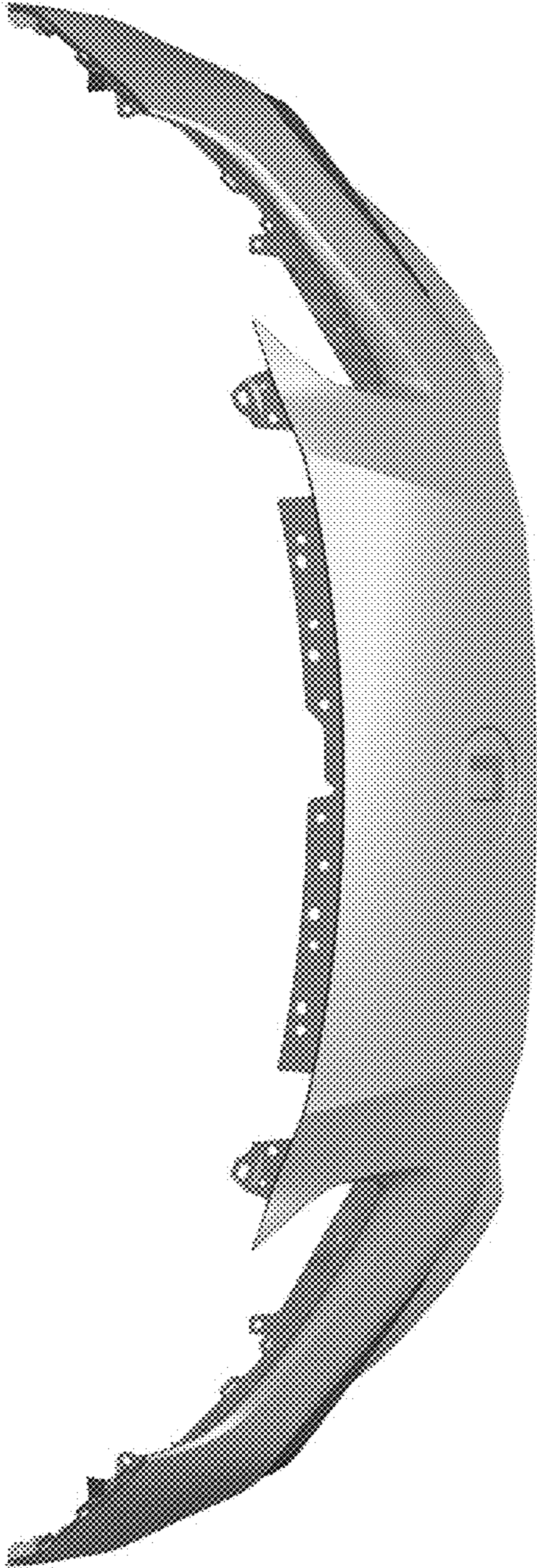

FIG. 6

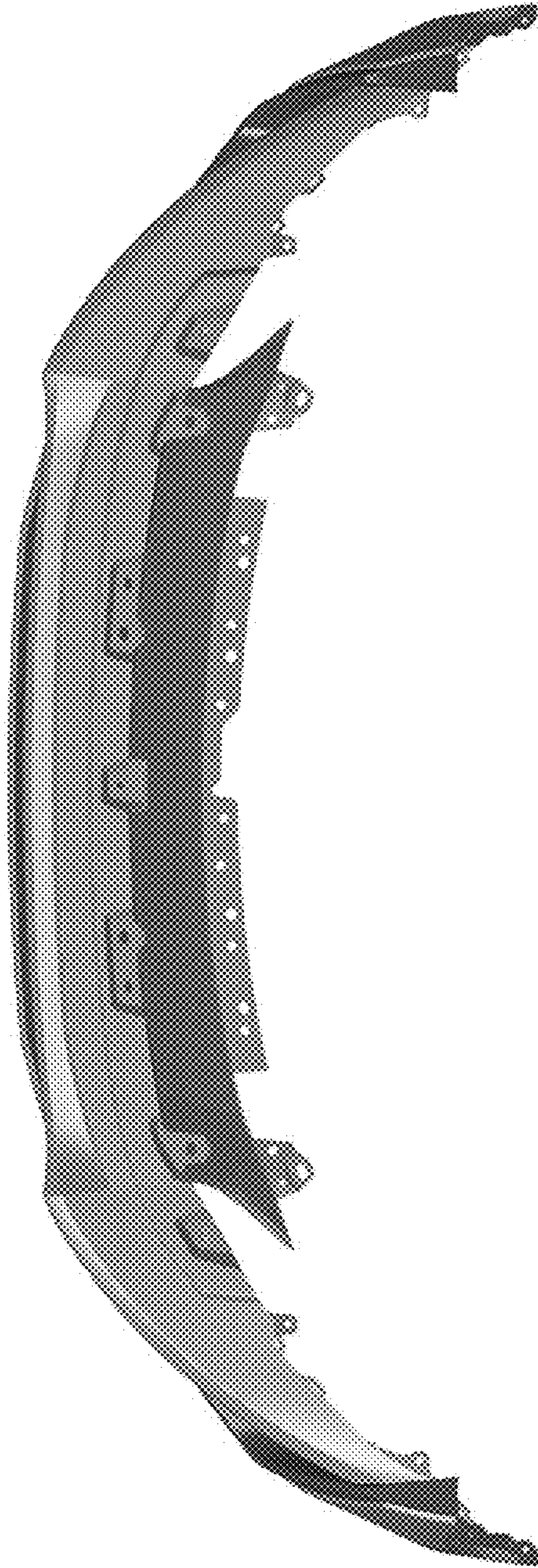

FIG. 7