



US00D93999S

(12) **United States Design Patent**  
**Yung**

(10) **Patent No.:** **US D939,999 S**

(45) **Date of Patent:** **\*\* Jan. 4, 2022**

- (54) **FASTENER WITH WINGS FOR A WRISTBAND**
- (71) Applicant: **Michelle Sze Wan Yung**, Mid-Levels (HK)
- (72) Inventor: **Michelle Sze Wan Yung**, Mid-Levels (HK)
- (\*\*) Term: **15 Years**
- (21) Appl. No.: **29/708,227**
- (22) Filed: **Oct. 4, 2019**
- (51) **LOC (13) Cl.** ..... **11-01**
- (52) **U.S. Cl.**  
USPC ..... **D11/87**
- (58) **Field of Classification Search**  
USPC ..... D11/1-29, 57, 86-88, 93-94;  
D10/30-32, 38  
CPC .... A44C 5/00; A44C 5/14; A44C 5/18; A44C  
5/2066; A44C 5/2076; G04B 19/00  
See application file for complete search history.

- D665,975 S \* 8/2012 Monteparo ..... D2/741
- D715,201 S \* 10/2014 Lee ..... D12/190
- D721,983 S \* 2/2015 Kleen ..... D11/81
- D722,234 S \* 2/2015 BenDavid ..... D3/318
- D733,606 S \* 7/2015 Stevens ..... D11/14
- D763,728 S \* 8/2016 Hung ..... D11/125
- D868,617 S \* 12/2019 Craparo ..... D11/107
- D868,618 S \* 12/2019 Craparo ..... D11/107

\* cited by examiner

*Primary Examiner* — Zenia I Bennett  
(74) *Attorney, Agent, or Firm* — Muncy, Geissler, Olds & Lowe, P.C.

(57) **CLAIM**

The ornamental design for a fastener with wings for a wristband, as shown and described.

**DESCRIPTION**

FIG. 1 is a perspective view of the fastener with wings for a wristband showing my new design; FIG. 2 is a front elevational view thereof; FIG. 3 is a rear elevational view thereof; FIG. 4 is a left side elevational view thereof; FIG. 5 is a right side elevational view thereof; FIG. 6 is a top plan view thereof; and, FIG. 7 is a bottom plan view thereof. The broken lines illustrate portions of the fastener with wings for a wristband which form no part of the claimed design.

(56) **References Cited**

U.S. PATENT DOCUMENTS

- D469,131 S \* 1/2003 Gant ..... D21/386
- D527,171 S \* 8/2006 Frederick ..... D2/741
- D665,972 S \* 8/2012 Monteparo ..... D2/741
- D665,973 S \* 8/2012 Monteparo ..... D2/741

**1 Claim, 7 Drawing Sheets**

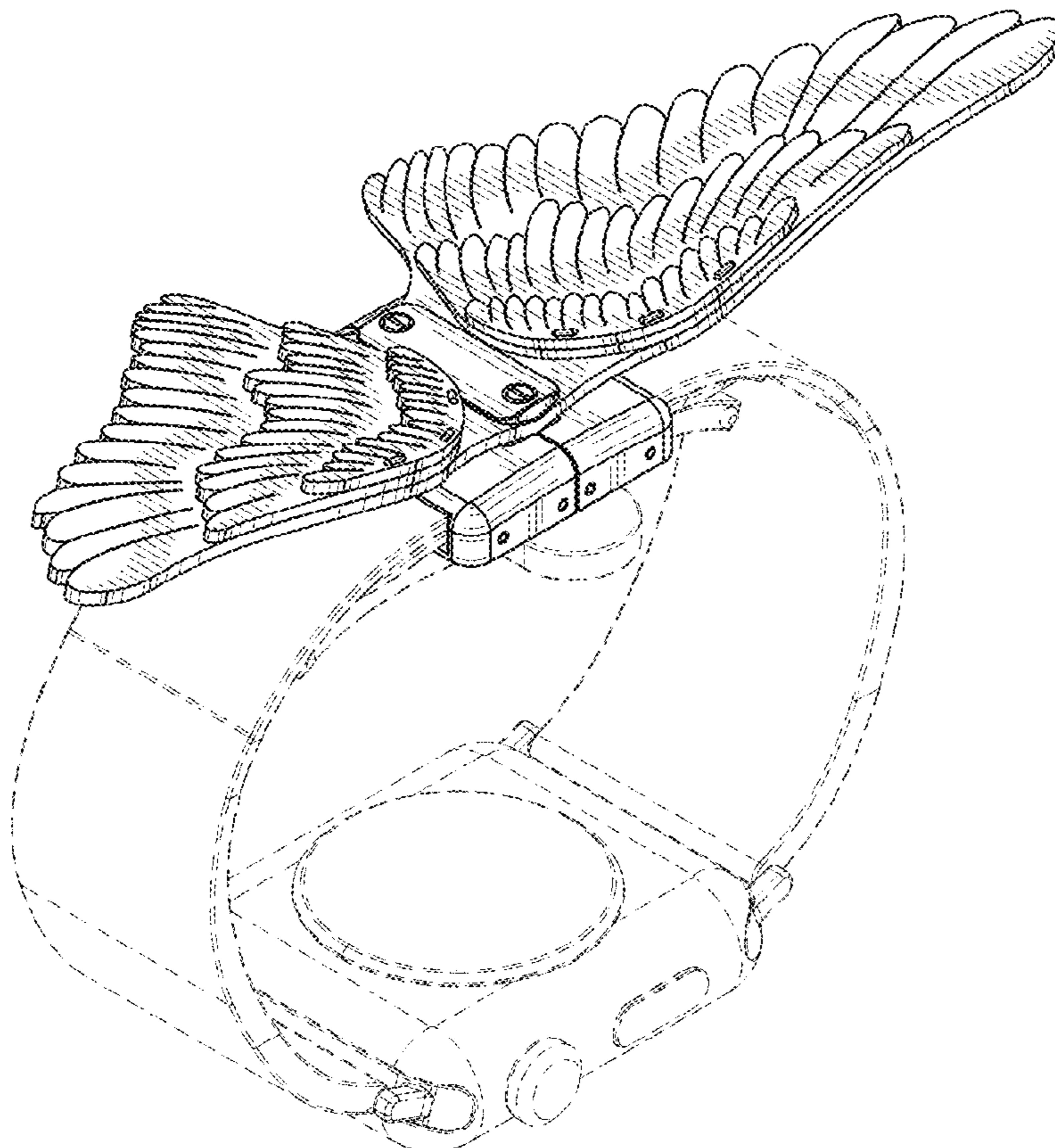

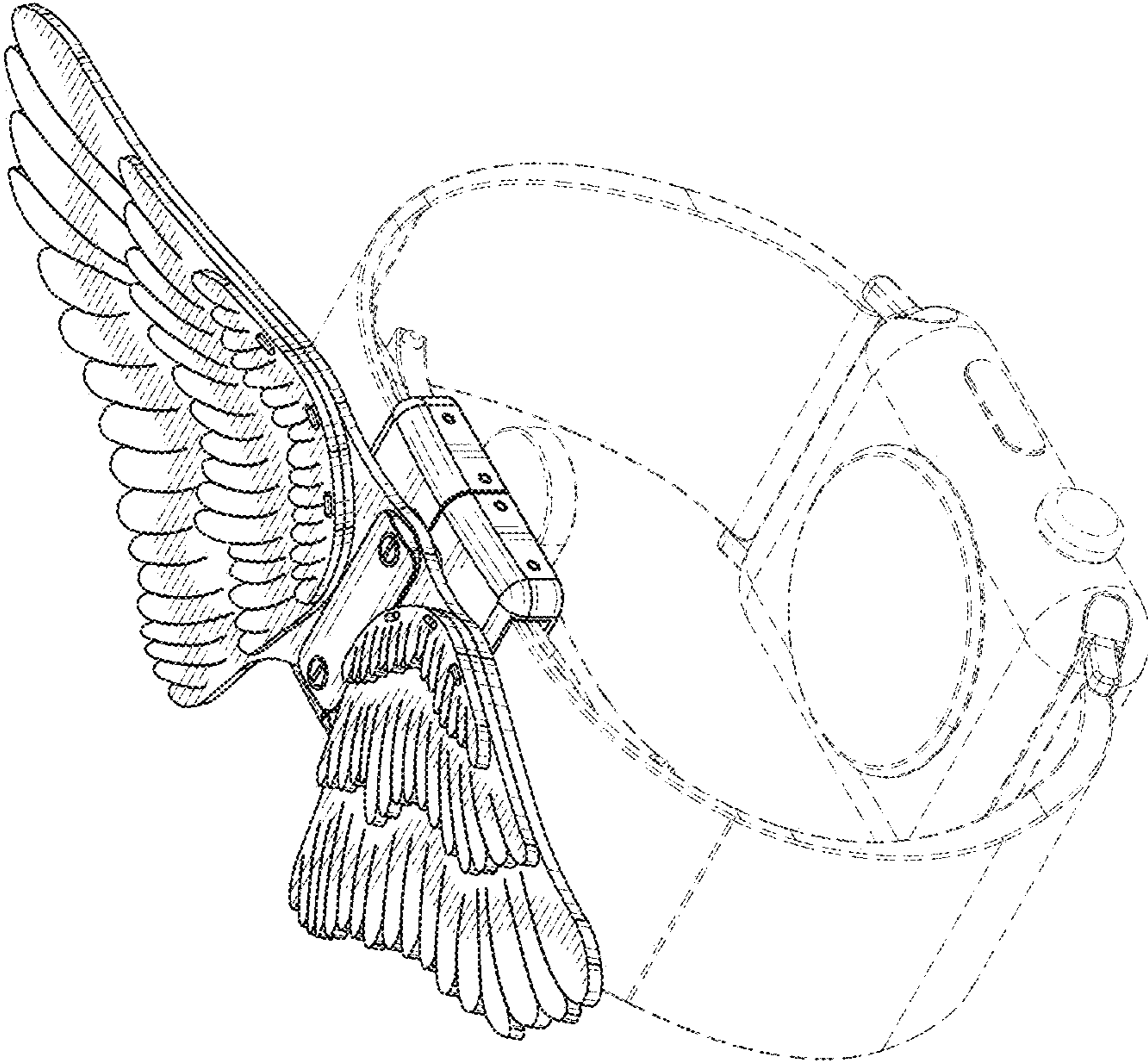

Fig.1

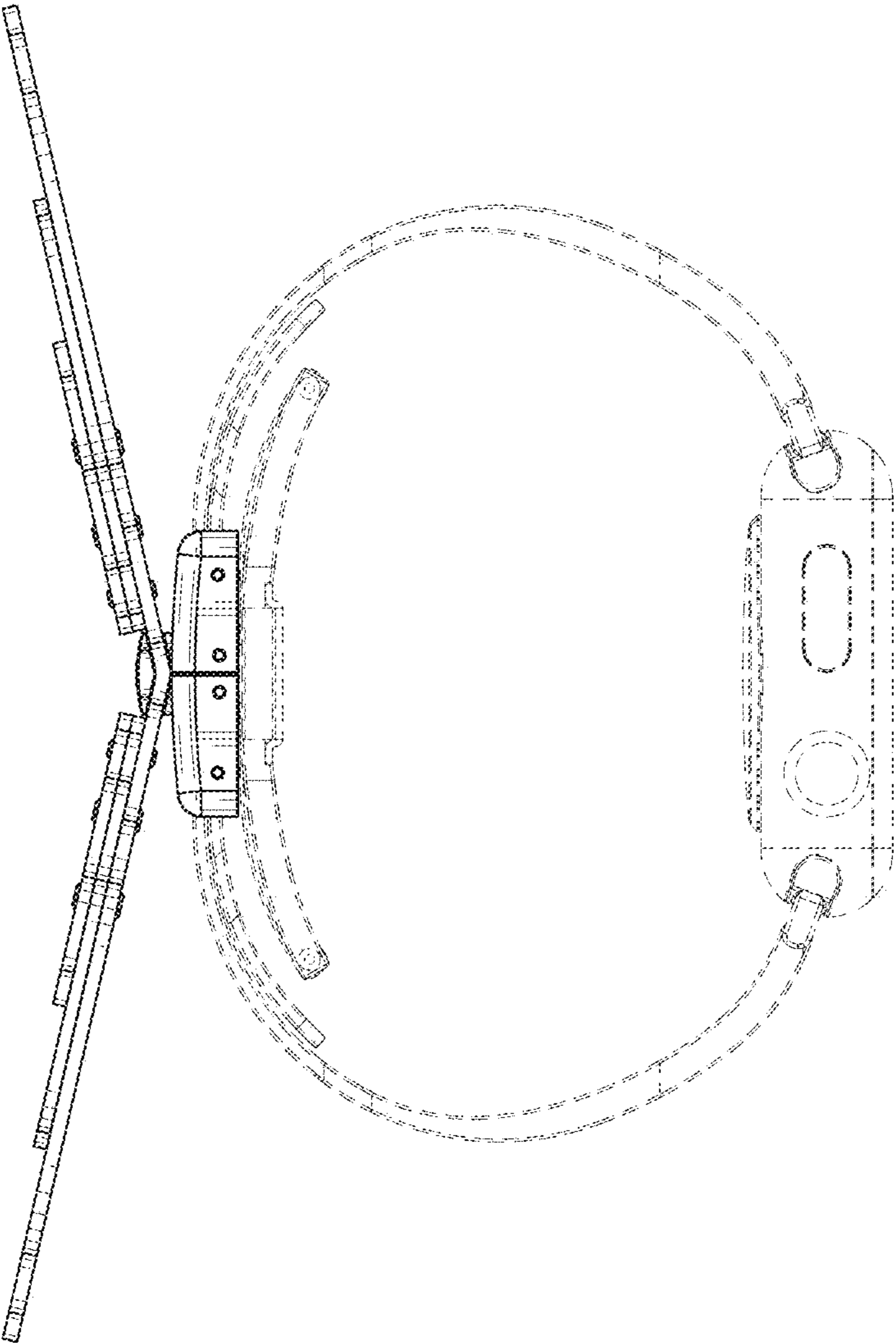

Fig.2

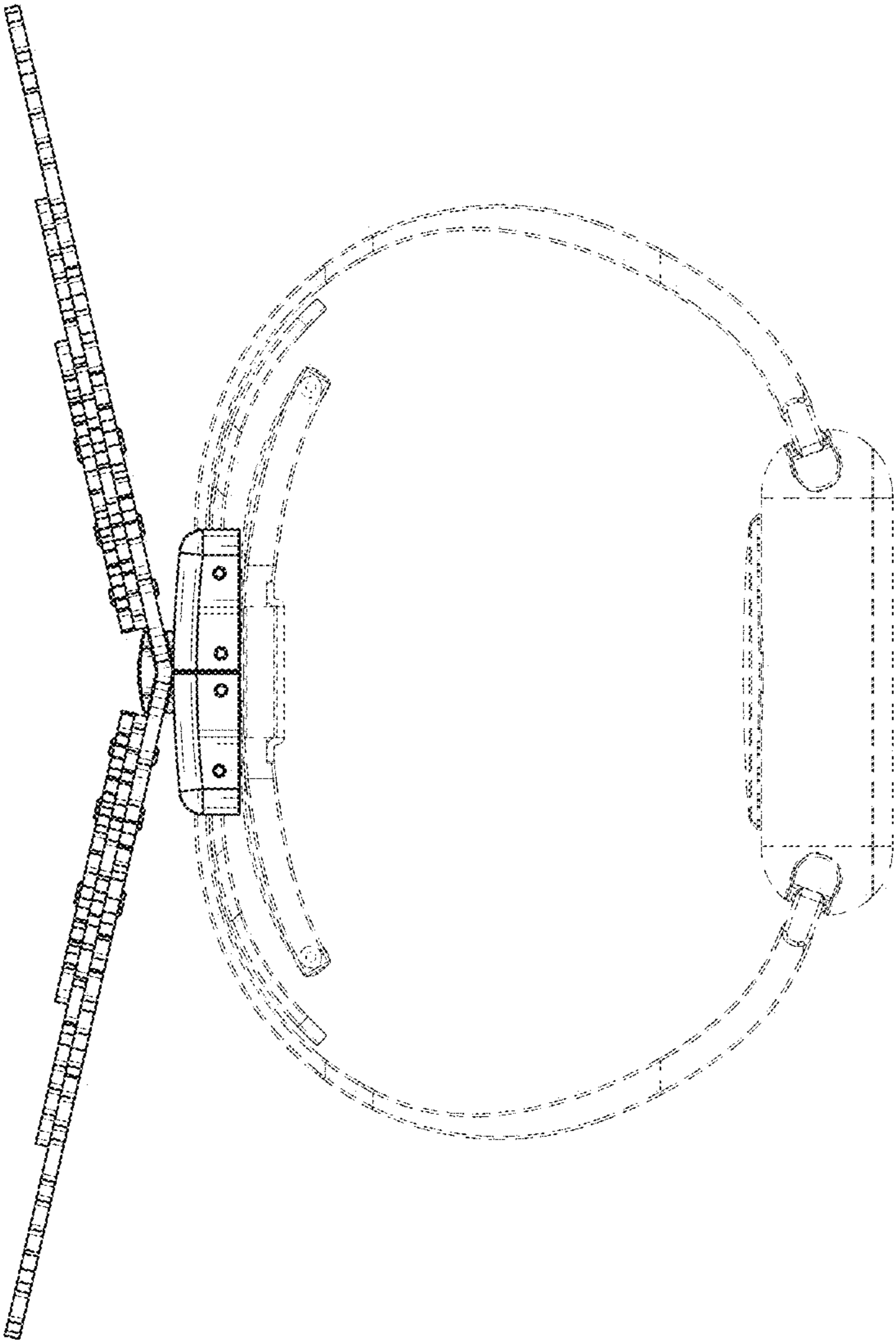

Fig.3

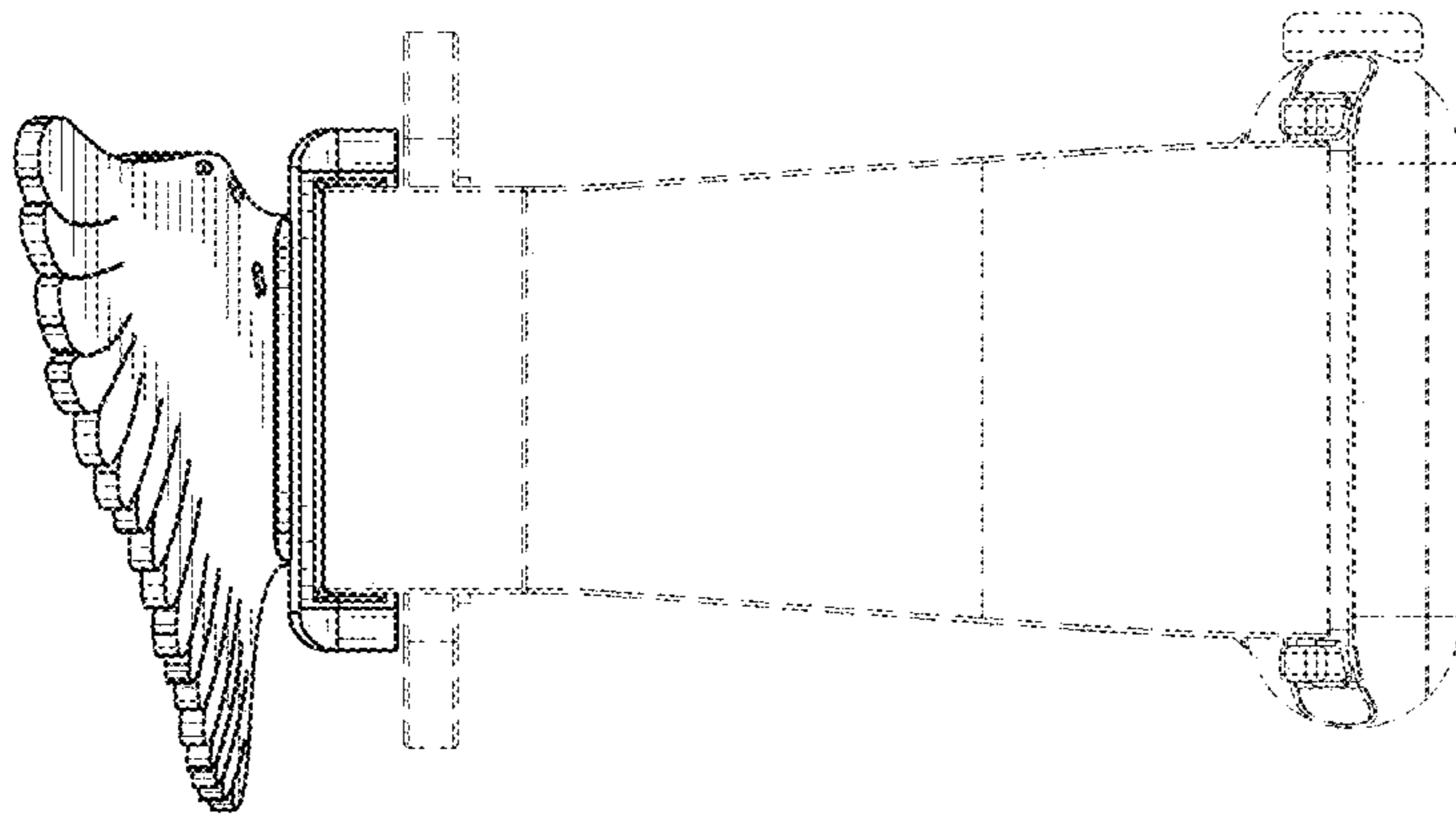

Fig.4

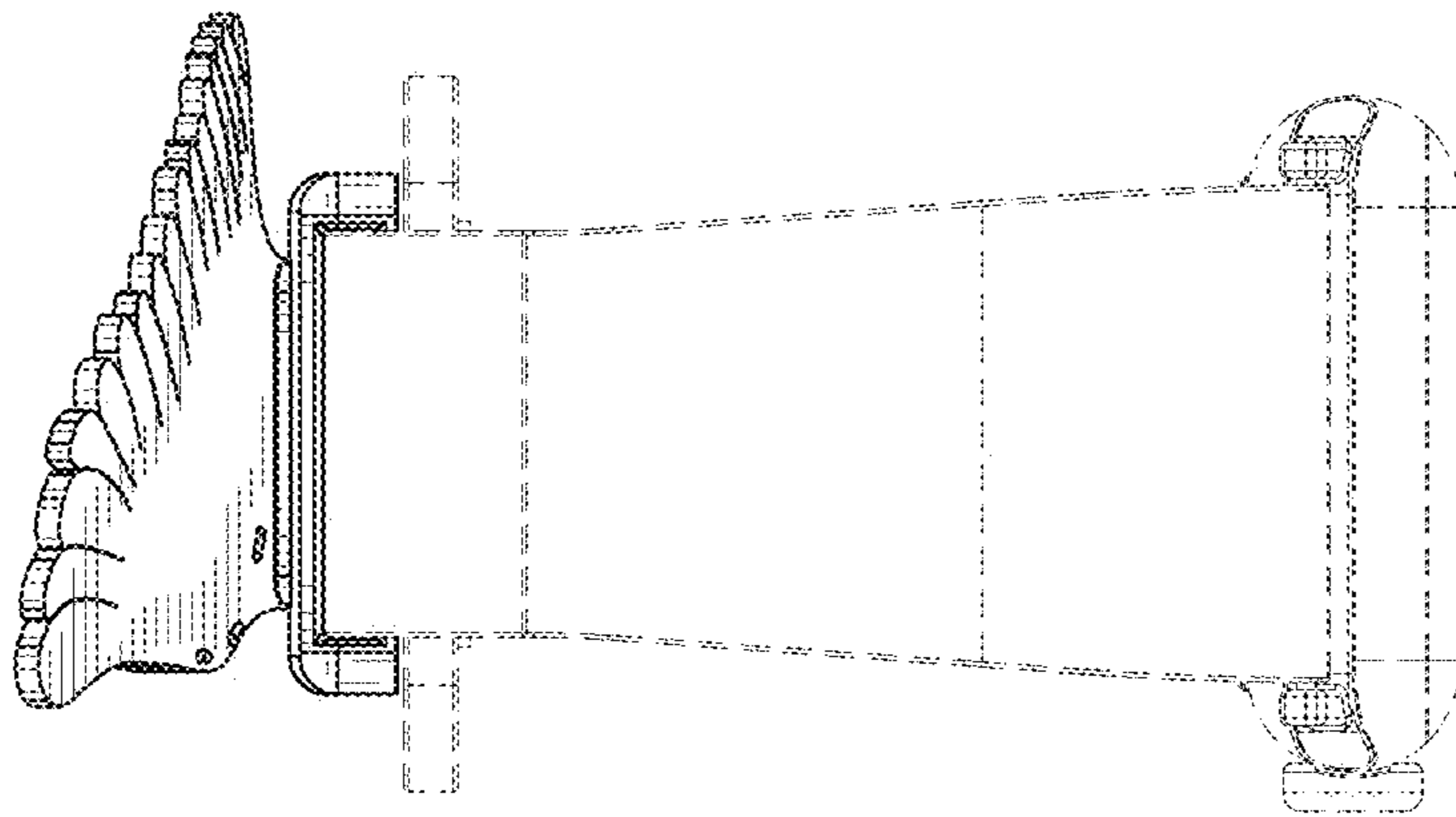

Fig. 5

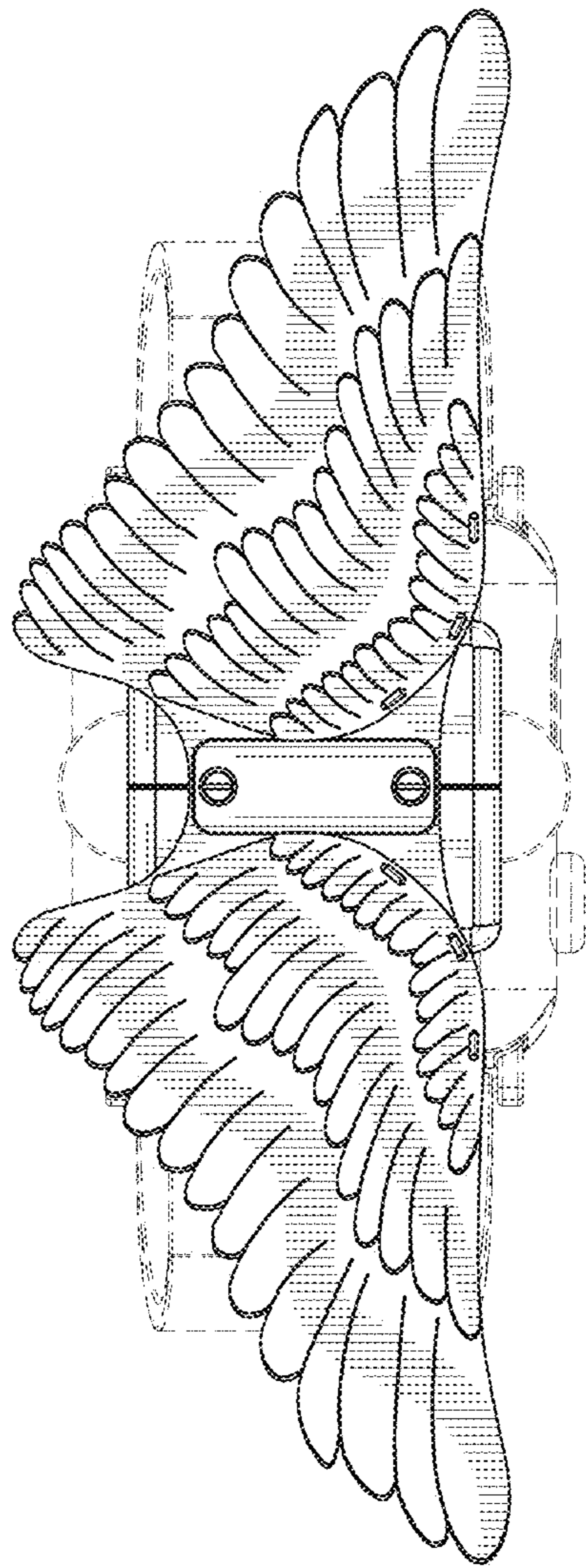

Fig.6

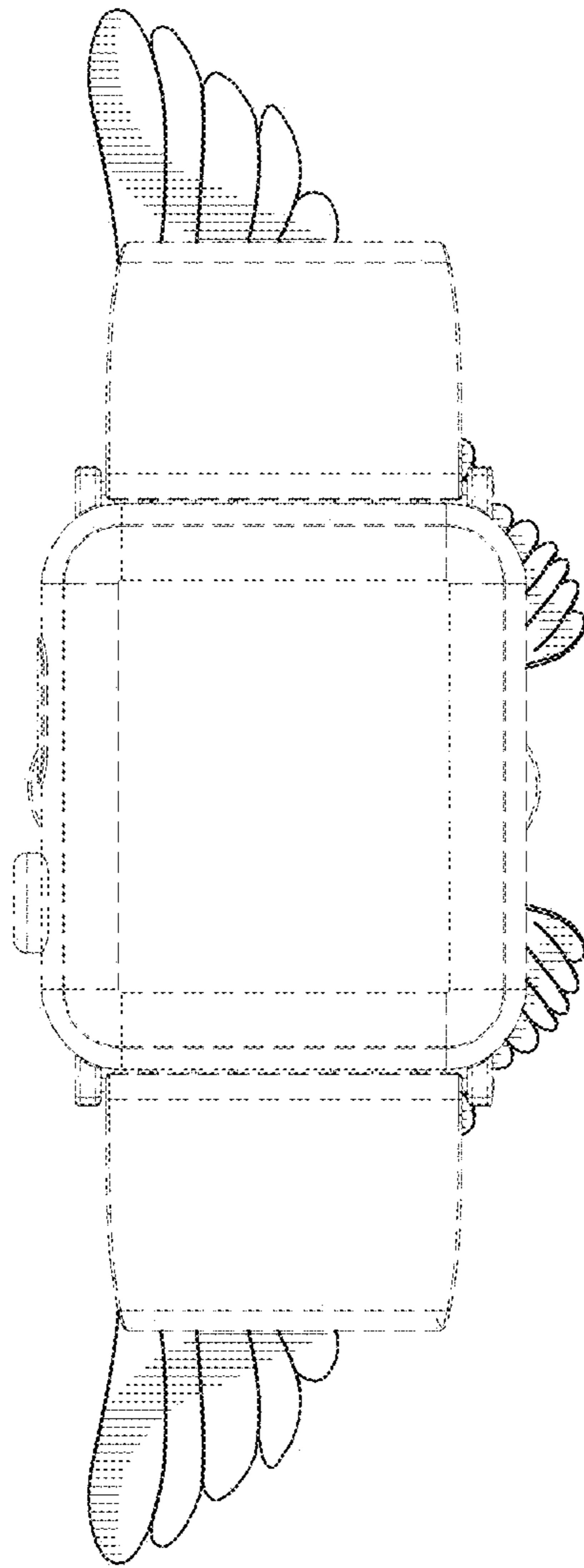

Fig. 7