



US00D939807S

(12) **United States Design Patent** (10) **Patent No.:** **US D939,807 S**
Yamada (45) **Date of Patent:** **** Jan. 4, 2022**

(54) **DISPOSABLE UNDERWEAR**

(71) Applicant: **Kikuo Yamada**, Shinagawa-ku (JP)

(72) Inventor: **Kikuo Yamada**, Shinagawa-ku (JP)

(**) Term: **15 Years**

(21) Appl. No.: **29/667,332**

(22) Filed: **Oct. 19, 2018**

(30) **Foreign Application Priority Data**

Feb. 23, 2018 (JP) 2018-003770

(51) **LOC (13) Cl.** **02-01**

(52) **U.S. Cl.**
USPC **D2/712; D24/126**

(58) **Field of Classification Search**
USPC D2/711-713; D24/124, 126; D5/60
CPC A41D 1/062; A41D 1/065; A41D 1/067;
A41D 1/08; A41D 7/00; A41D 7/005;
A41B 9/02; A61F 13/49011
See application file for complete search history.

(56) **References Cited**

U.S. PATENT DOCUMENTS

D331,627 S	*	12/1992	Igaue	D24/126
D348,102 S	*	6/1994	Gegelys	D24/124
D444,554 S	*	7/2001	O'Hara	D24/125
D489,821 S	*	5/2004	Glaug	D24/126
D554,870 S	*	11/2007	Harkenrider	D5/60
D663,921 S	*	7/2012	Wexler	D2/712
D690,903 S	*	10/2013	Wexler	A41B 9/12
					D2/712
D713,619 S	*	9/2014	Wexler	D2/713
D760,993 S	*	7/2016	Dawkins	D2/712
D800,300 S	*	10/2017	Yamada	D24/126
D805,191 S		12/2017	Yamada		
D805,635 S		12/2017	Yamada		
D806,867 S		1/2018	Yamada		
D834,785 S	*	12/2018	Yamada	D2/712

(Continued)

OTHER PUBLICATIONS

Wealurre Breathable Underwear Women Seamless Bikini Nylon Spandex Mesh Panties, posted 2020 [online], (retrieved 10/19/2020). Retrieved from the internet, https://www.amazon.com/Wealurre-Breathable-Underwear-Seamless-Color/dp/B07CVT916W/ref=pd_di_sccai_5/143-6695232-1484047?_encoding=%E2%80%A6 (Year: 2020).*

(Continued)

Primary Examiner — Kevin K Rudzinski

Assistant Examiner — J. Thorn, Sr.

(74) *Attorney, Agent, or Firm* — Oblon, McClelland, Maier & Neustadt, L.L.P.

(57) **CLAIM**

The ornamental design for disposable underwear, as shown and described.

DESCRIPTION

FIG. 1 is a front elevational view of disposable underwear according to my design;
FIG. 2 is a top plan view thereof;
FIG. 3 is a back elevational view thereof;
FIG. 4 is a bottom plan view thereof;
FIG. 5 is a right side elevational view thereof, the left side elevational view thereof being a mirror image of the right side elevational view;
FIG. 6 is a sectional view thereof at lines A-A of FIG. 1;
FIG. 7 is a sectional view thereof at lines B-B of FIG. 1;
FIG. 8 is a sectional view thereof at lines C-C of FIG. 2;
FIG. 9 is a sectional view thereof at lines D-D of FIG. 2;
FIG. 10 is an enlarged view of a portion thereof at section 10 of FIG. 1; and,
FIG. 11 is an enlarged view of a portion thereof at section 11 of FIG. 1.
The uneven broken lines in each of FIG. 10 and FIG. 11 represent a boundary line and form no part of the claimed design.

1 Claim, 11 Drawing Sheets

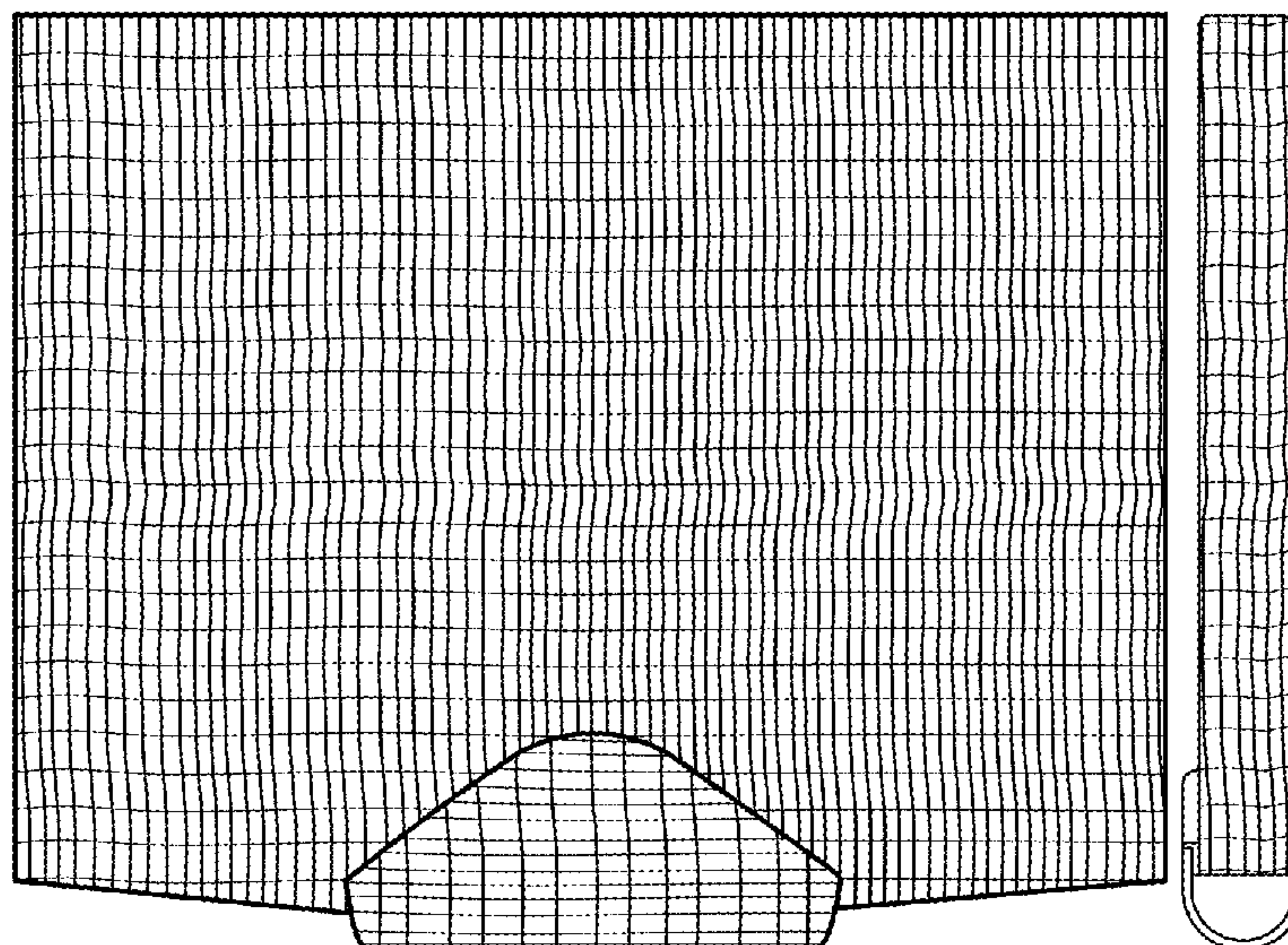

(56)

References Cited

U.S. PATENT DOCUMENTS

D865,162 S * 10/2019 Yamada D24/126
D871,779 S * 1/2020 Yamada D5/60
2002/0087137 A1* 7/2002 Christoffel A61F 13/15
604/385.01
2016/0347030 A1* 12/2016 Yamada B32B 3/08
2018/0280208 A1* 10/2018 Yamada B32B 25/10
2020/0305515 A1* 10/2020 Bradley A41B 9/001

OTHER PUBLICATIONS

Innersy Womens Cotton Period Panties Heavy Flow Menstrual Underwear, posted 2018 [online], (retrieved 10/19/2020). Retrieved from the internet, https://www.amazon.com/dp/B083DP53HH/ref=sspa_dk_detail_7?psc=1&pd_rd_i=B083DP53HH&pd_rd_w=13kYU&pf_rd_p=7d37a48b-2b1a-4373-%E2%80%A61/10 (Year: 2018).*

The easy way to sew a triangle crotch leggings gusset: Aila tutorial, posted 2019 [online], (retrieved 10/19/2020), Retrieved from the internet, <https://www.thelaststitch.com/sewing-triangle-crotch-leggings-gusset/> (Year: 2019).*

* cited by examiner

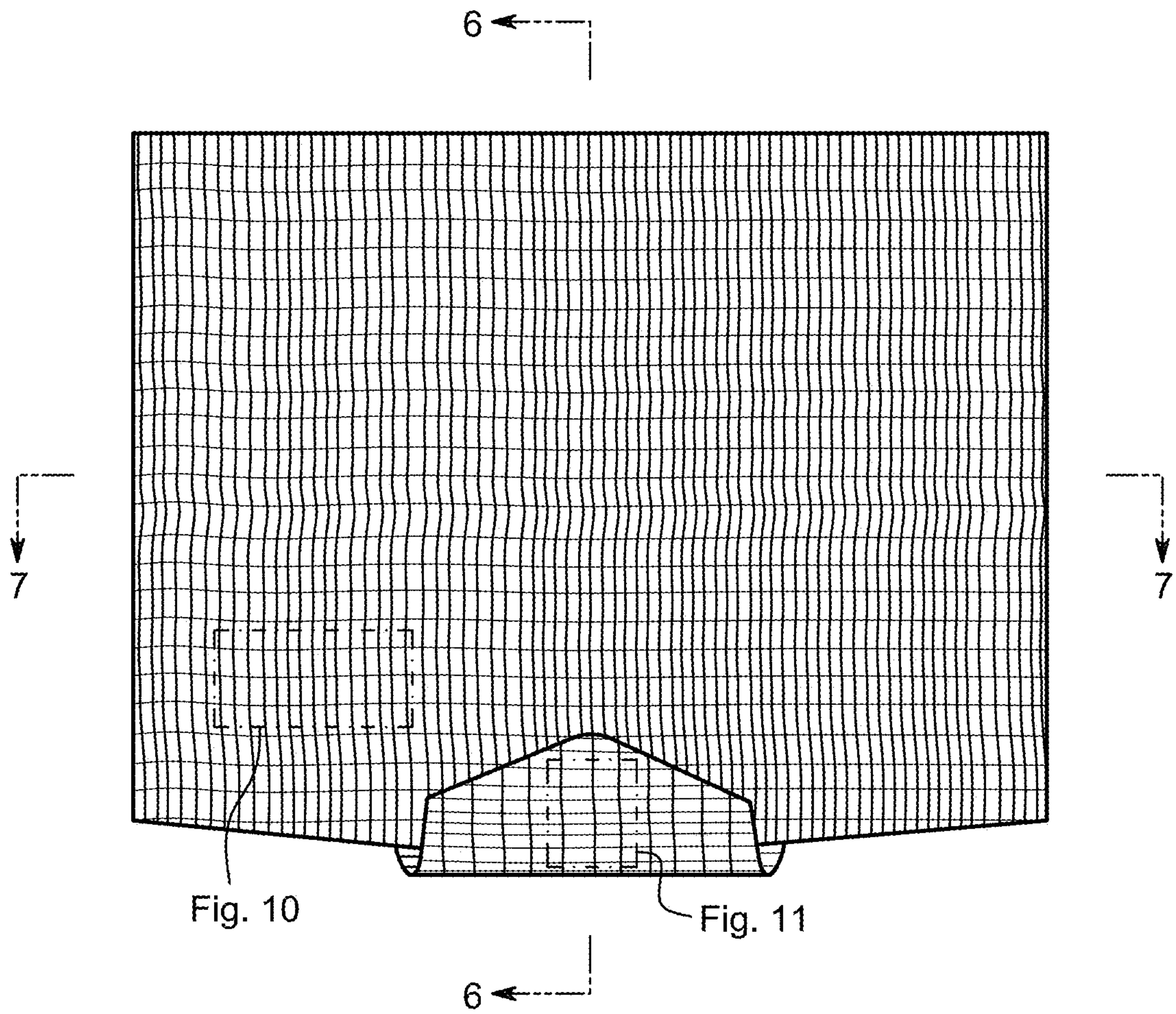

FIG. 1

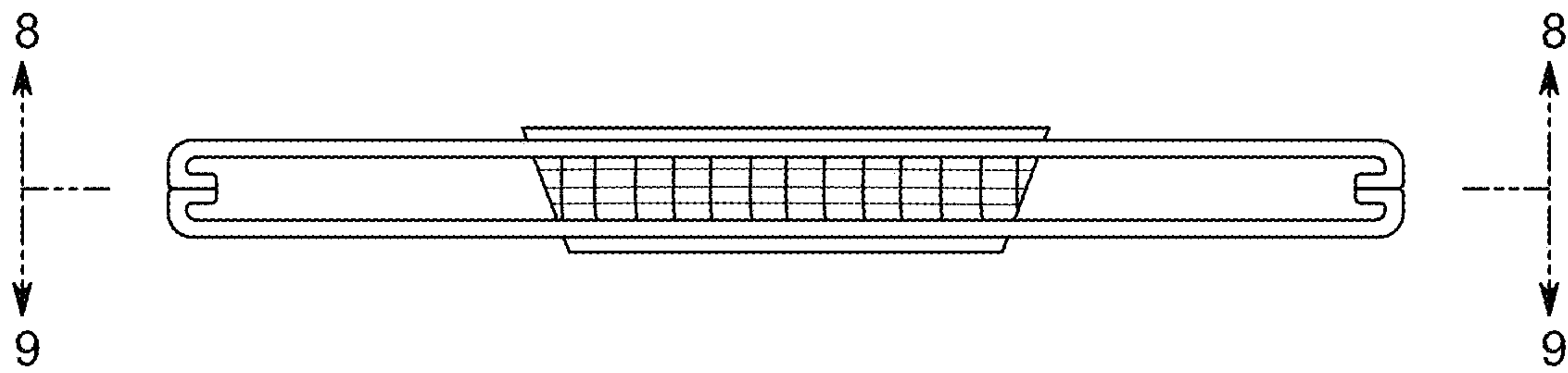

FIG. 2

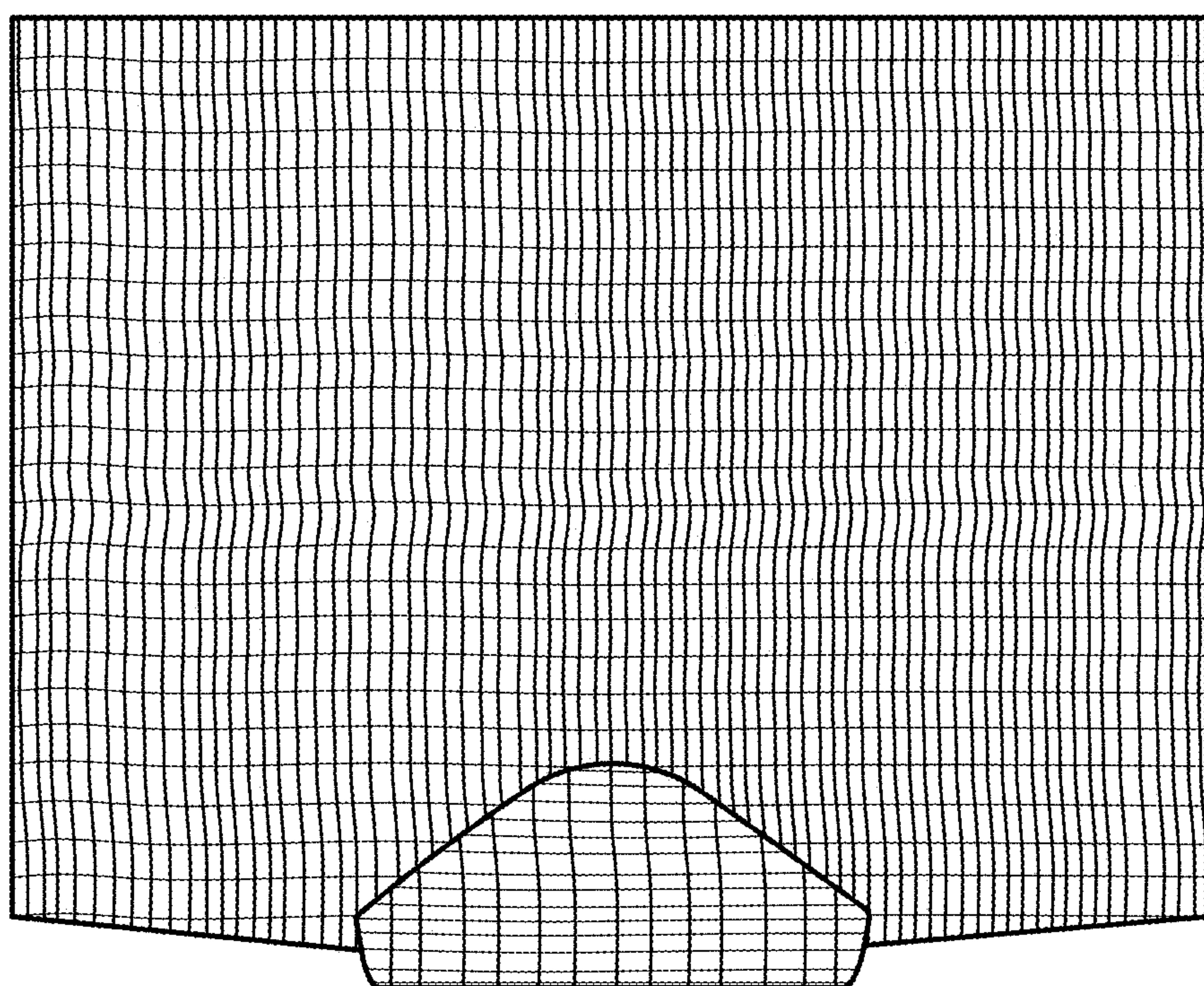

FIG. 3

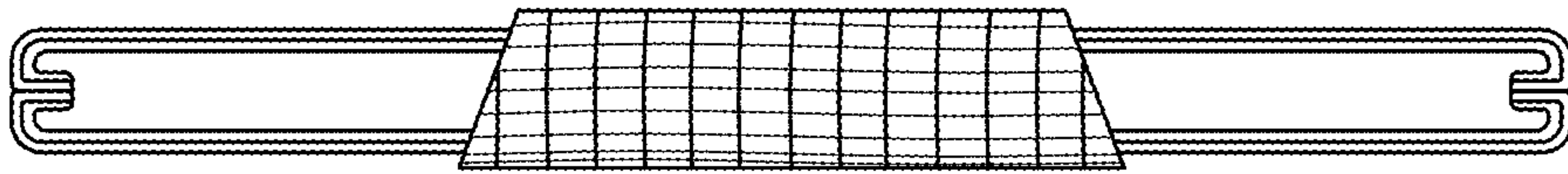

FIG. 4

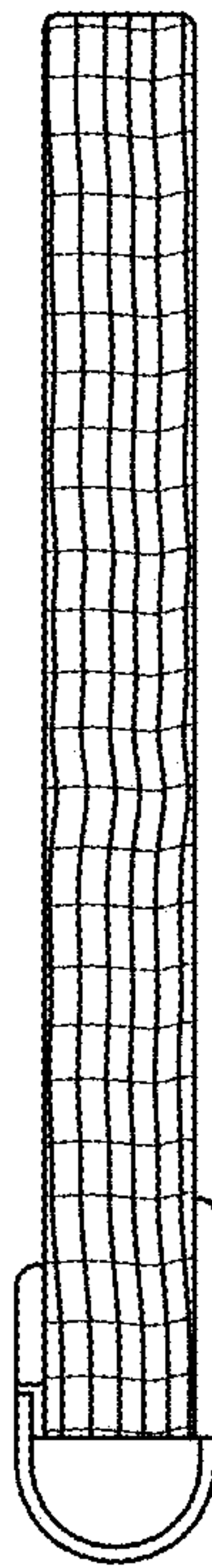

FIG. 5

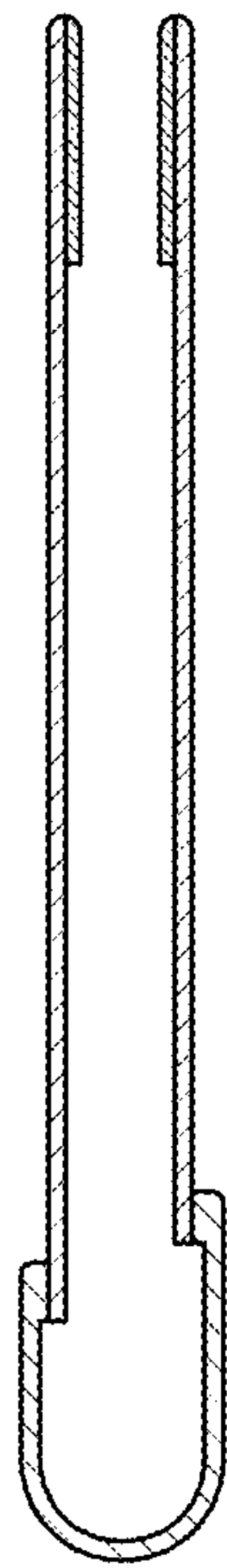

FIG. 6

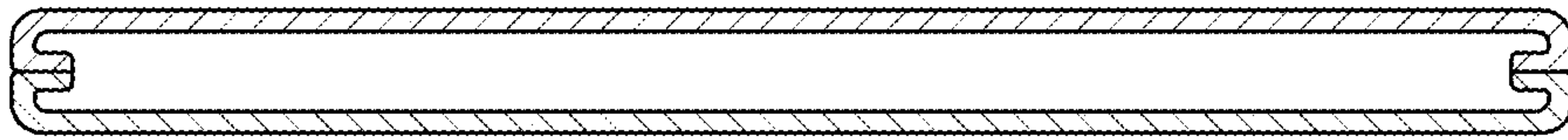

FIG. 7

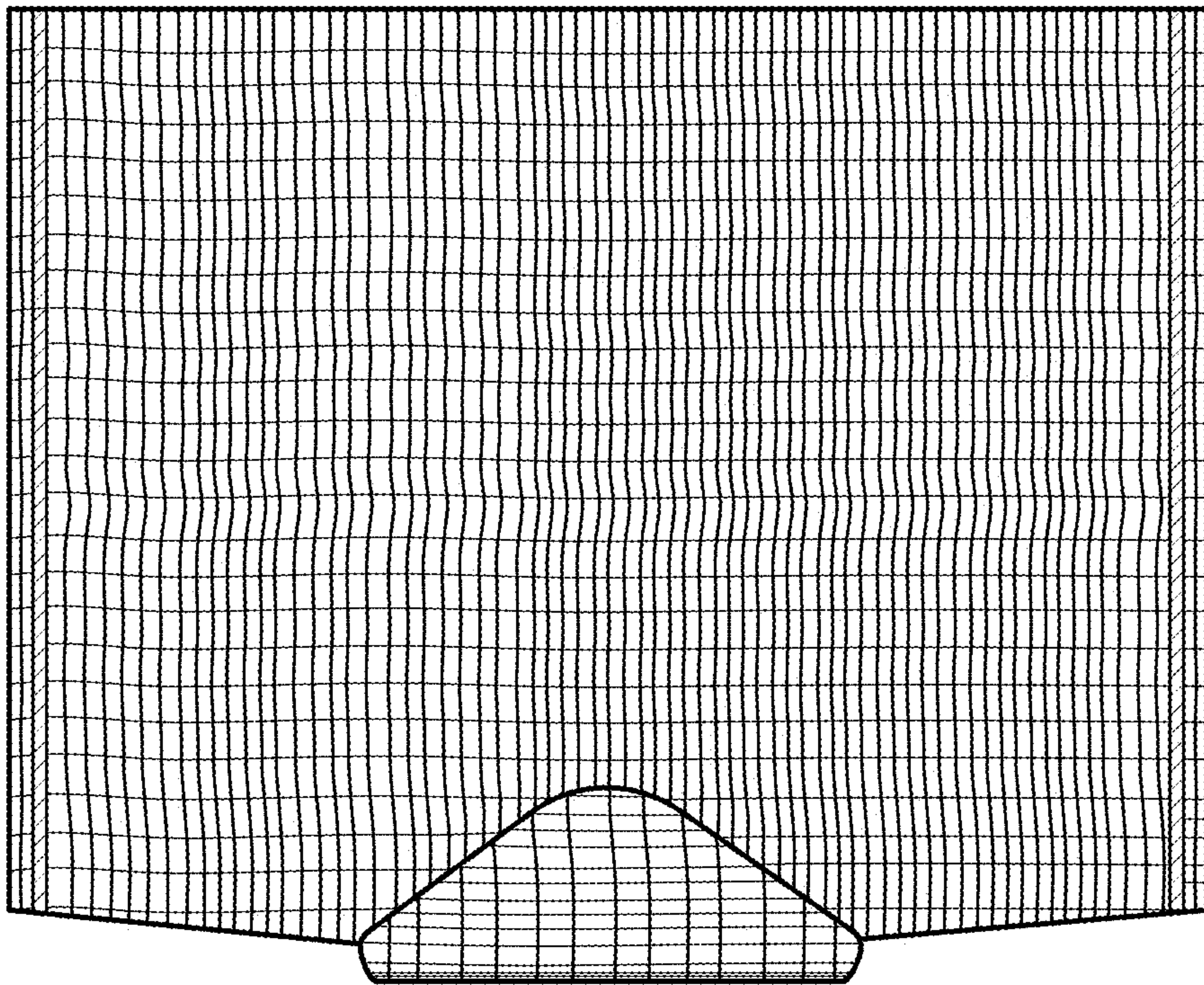

FIG. 8

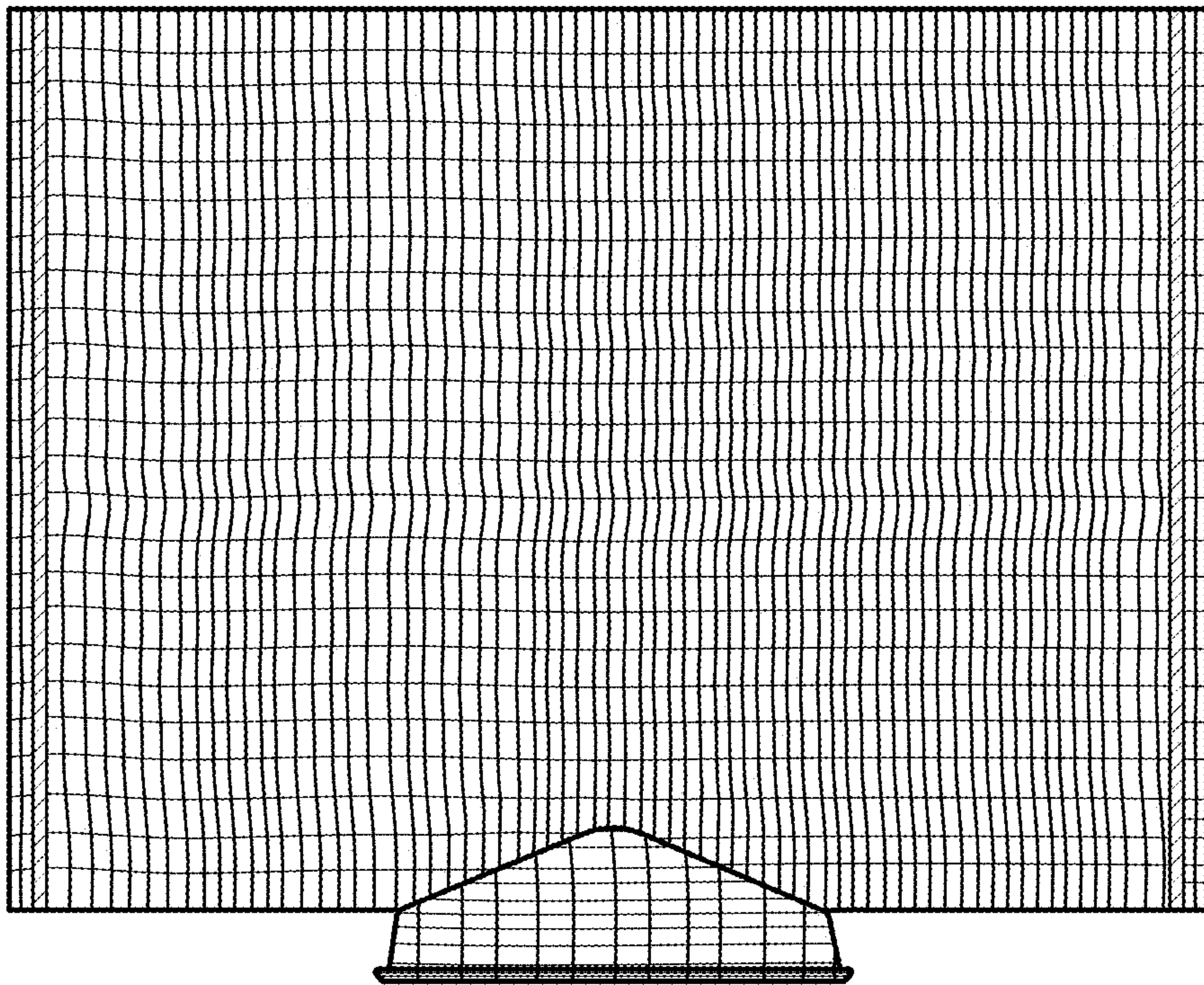

FIG. 9

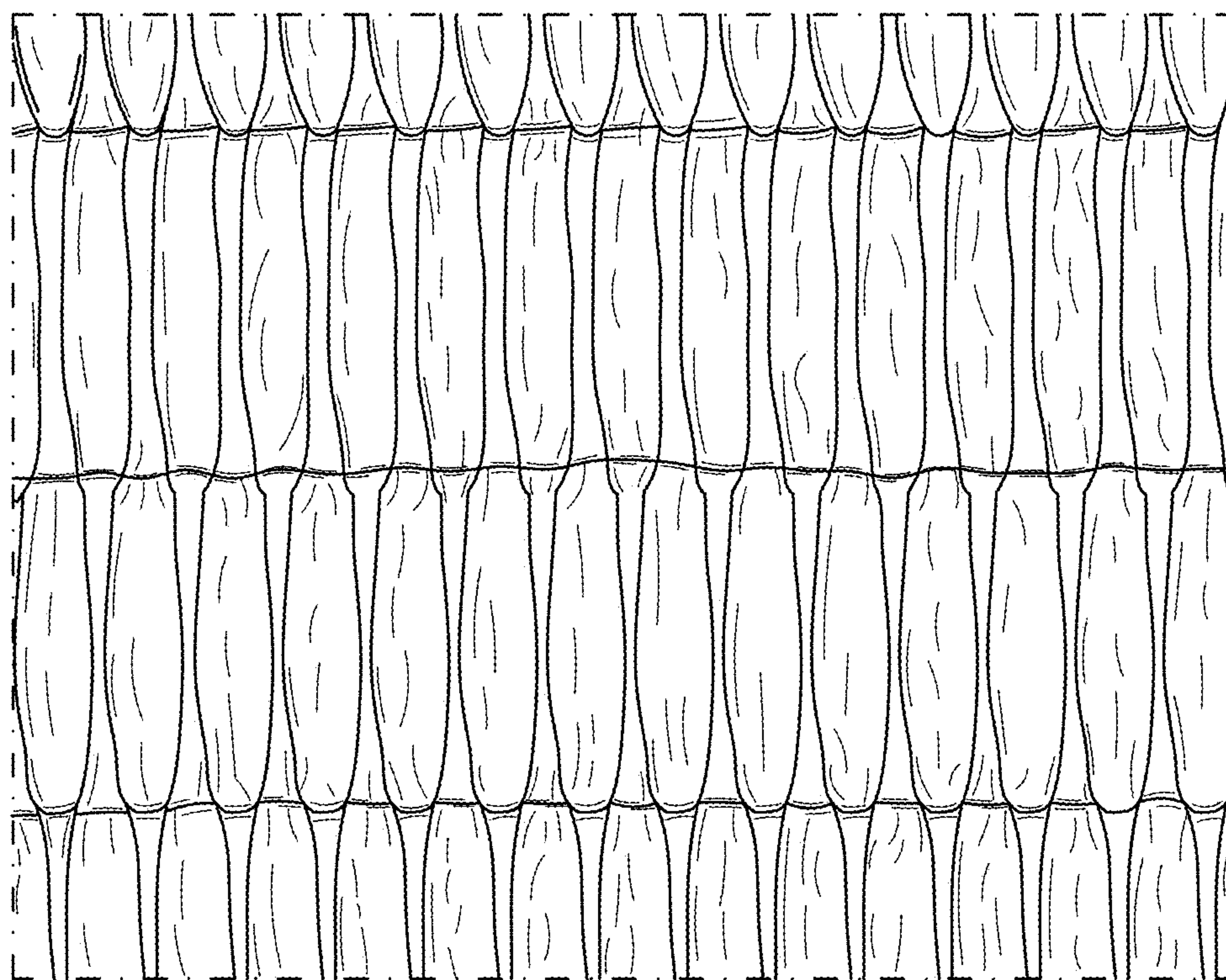

FIG. 10

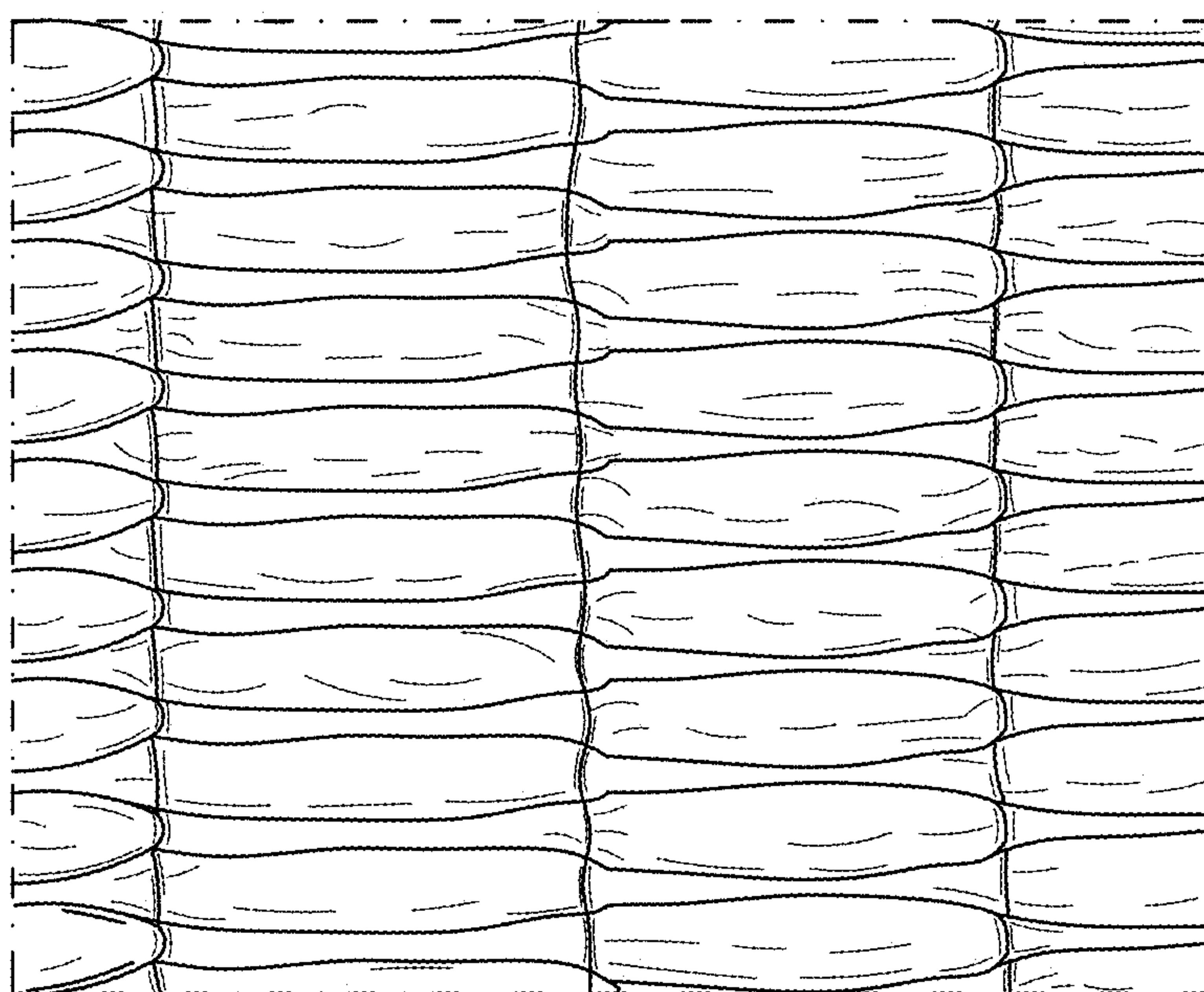

FIG. 11