



US00D939777S

(12) **United States Design Patent** (10) **Patent No.:** **US D939,777 S**  
**Geisinsky et al.** (45) **Date of Patent:** **\*\* Dec. 28, 2021**

(54) **WIG GRIP CAP**

(74) *Attorney, Agent, or Firm* — Lance M. Pritikin

(71) Applicant: **NG Imports, Inc.**, Long Beach, CA (US)

(57) **CLAIM**

The ornamental design for a wig grip cap, as shown and described.

(72) Inventors: **Yehudis Geisinsky**, Long Beach, CA (US); **Yitzchok Geisinsky**, Long Beach, CA (US)

**DESCRIPTION**

(73) Assignee: **NG Imports, Inc.**, Signal Hill, CA (US)

FIG. 1 is a front elevational view of a first embodiment of a wig grip cap, showing my new design, wherein the wig grip cap is shown deployed on the unclaimed head of a wearer;

(\*\*) Term: **15 Years**

FIG. 2 is a rear elevational view thereof;

(21) Appl. No.: **29/705,240**

FIG. 3 is a right side elevational view thereof;

(22) Filed: **Sep. 10, 2019**

FIG. 4 is a left side elevational view thereof;

(51) **LOC (13) Cl.** ..... **28-04**

FIG. 5 is a top plan view thereof;

(52) **U.S. Cl.**

FIG. 6 is a front perspective view thereof;

USPC ..... **D28/93**

FIG. 7 is a rear perspective view thereof;

(58) **Field of Classification Search**

USPC ..... D28/92, 93

FIG. 8 is a front perspective view of the wig grip cap of FIG. 1;

CPC ... A41G 3/00; A41G 5/00; A41G 5/04; A41G 5/0046; A41G 5/0053; A41G 5/006; A41G 5/0066; A41G 5/0073

FIG. 9 is a bottom perspective view thereof, wherein a securement feature of the wig grip cap is shown in an unsecured configuration;

See application file for complete search history.

FIG. 10 is a front elevational view of a second embodiment of a wig grip cap, showing my new design, wherein the wig grip cap is shown deployed on the unclaimed head of a wearer;

(56) **References Cited**

FIG. 11 is a rear elevational view thereof;

**U.S. PATENT DOCUMENTS**

FIG. 12 is a right side elevational view thereof;

3,688,779 A \* 9/1972 Greco ..... A41G 3/0041  
132/53

FIG. 13 is a left side elevational view thereof;

5,592,957 A \* 1/1997 Gazerro ..... A41G 3/00  
132/201

FIG. 14 is a top plan view thereof;

6,352,079 B1 \* 3/2002 Bate ..... A41G 3/00  
132/54

FIG. 15 is a front perspective view thereof;

6,935,349 B2 \* 8/2005 Nicot ..... A41G 3/0016  
132/53

FIG. 16 is a rear perspective view thereof;

2004/0168696 A1 \* 9/2004 Cox ..... A41G 3/0041  
132/54

FIG. 17 is a front perspective view of the wig grip cap of FIG. 10; and,

(Continued)

FIG. 18 is a bottom perspective view thereof, wherein a securement feature of the wig grip cap is shown in an unsecured configuration.

The broken lines in the drawings depicting stitching and the human form in FIGS. 1-18 are for illustrative purposes and form no part of the claimed design.

*Primary Examiner* — Zenia I Bennett

**1 Claim, 16 Drawing Sheets**

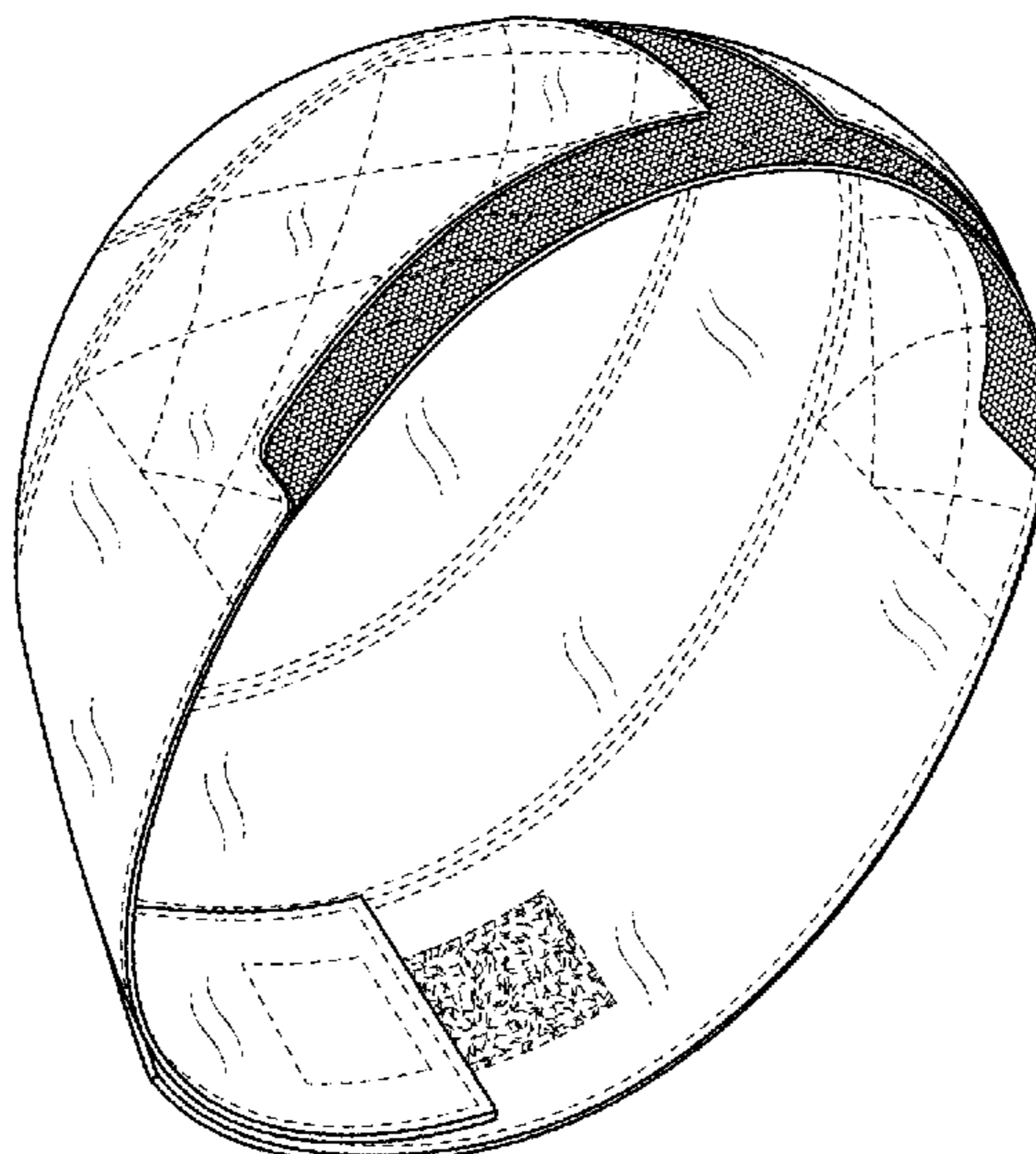

(56)

**References Cited**

U.S. PATENT DOCUMENTS

2005/0247324 A1\* 11/2005 Nicot ..... A41G 3/0025  
132/54  
2007/0221240 A1\* 9/2007 Junsuh Lee ..... A41G 5/0073  
132/201  
2009/0188512 A1\* 7/2009 Eaton ..... A41G 5/0073  
132/54

\* cited by examiner

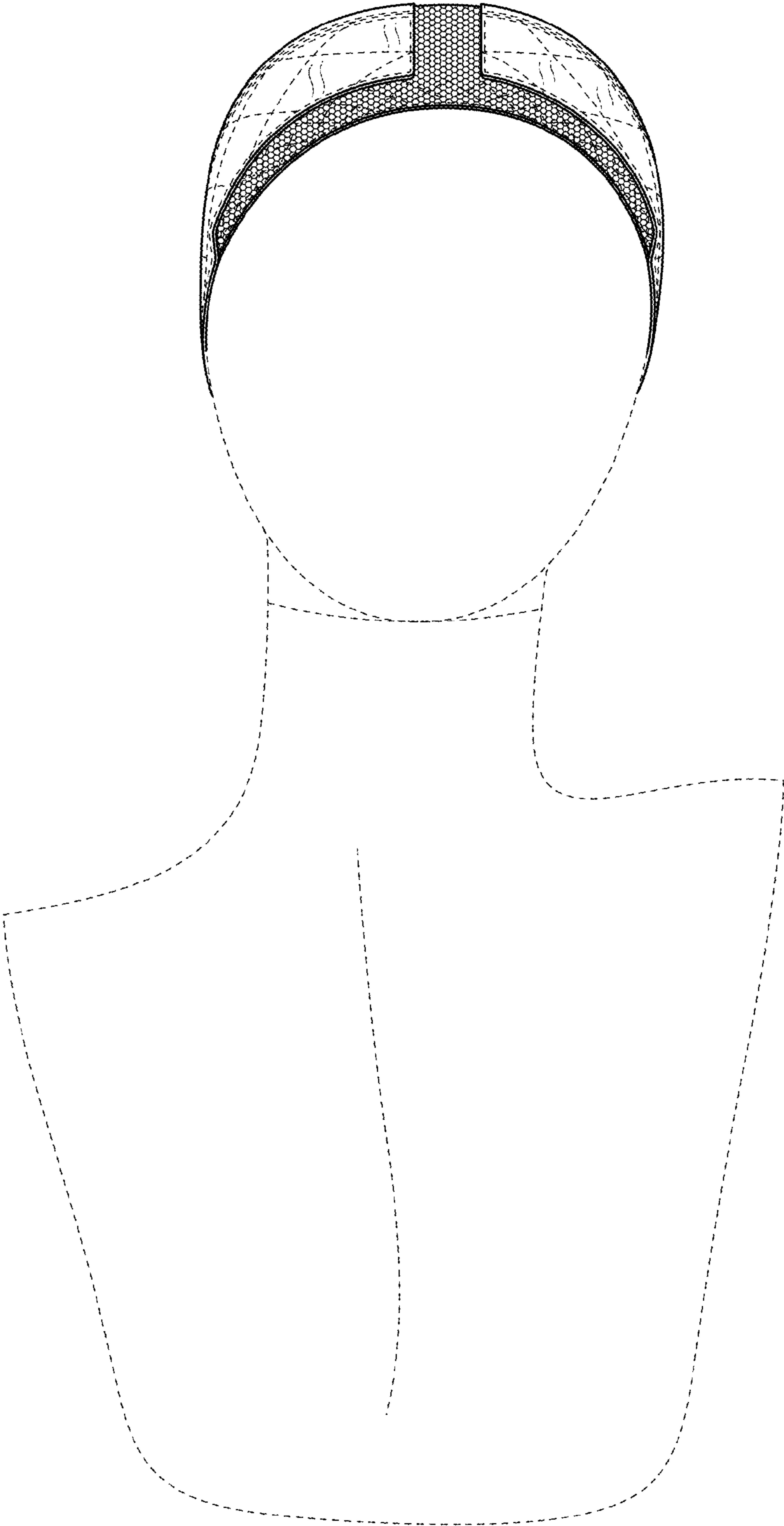

FIG. 1

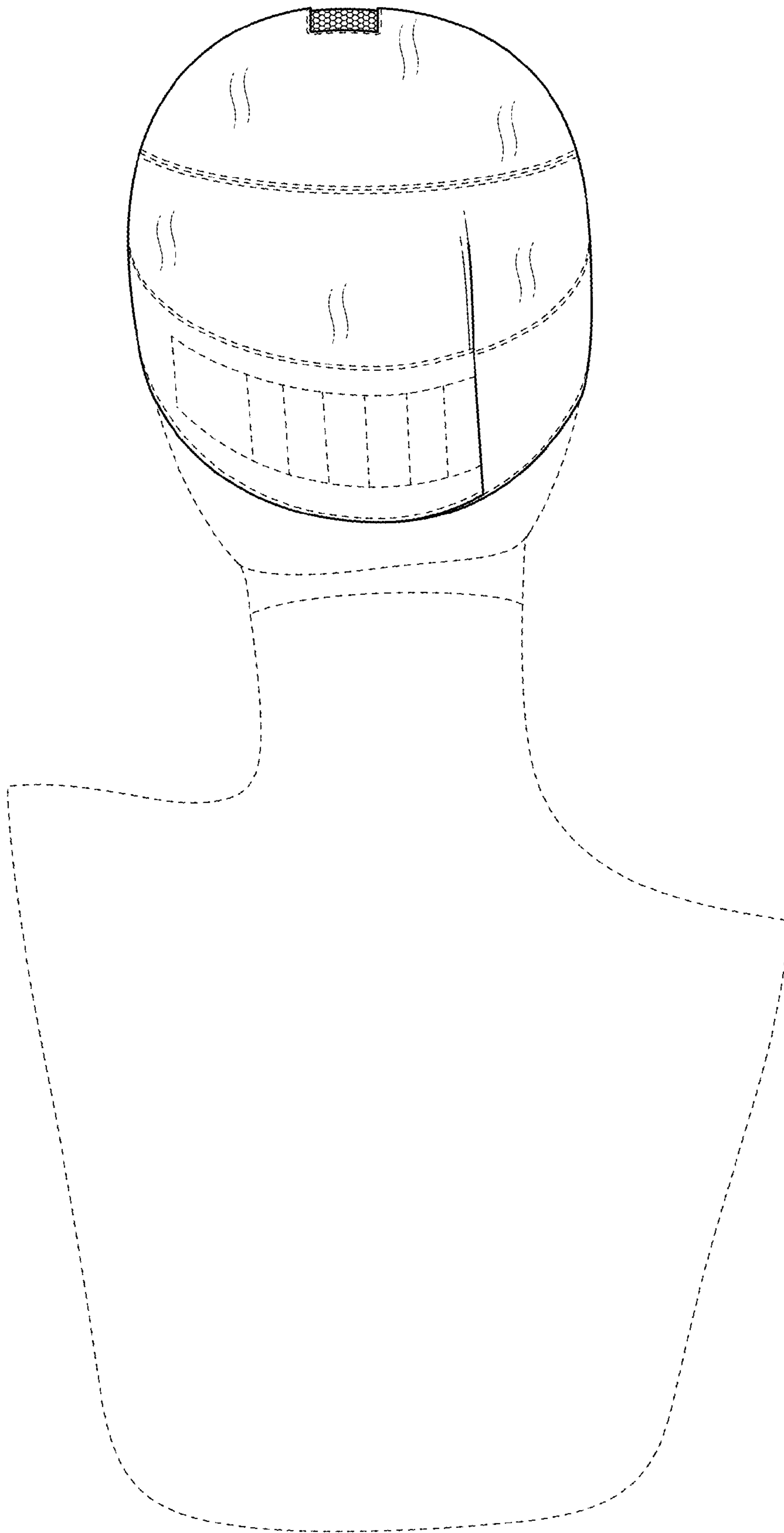

FIG. 2

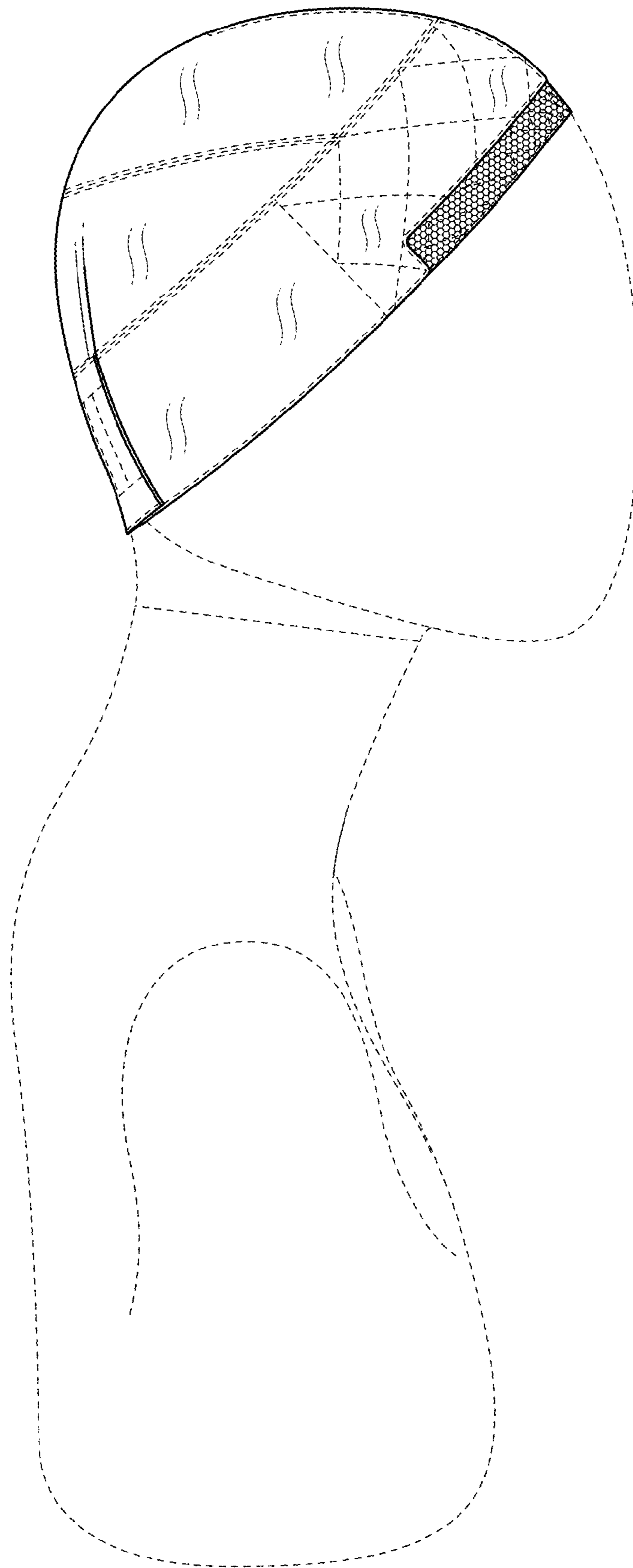

FIG. 3

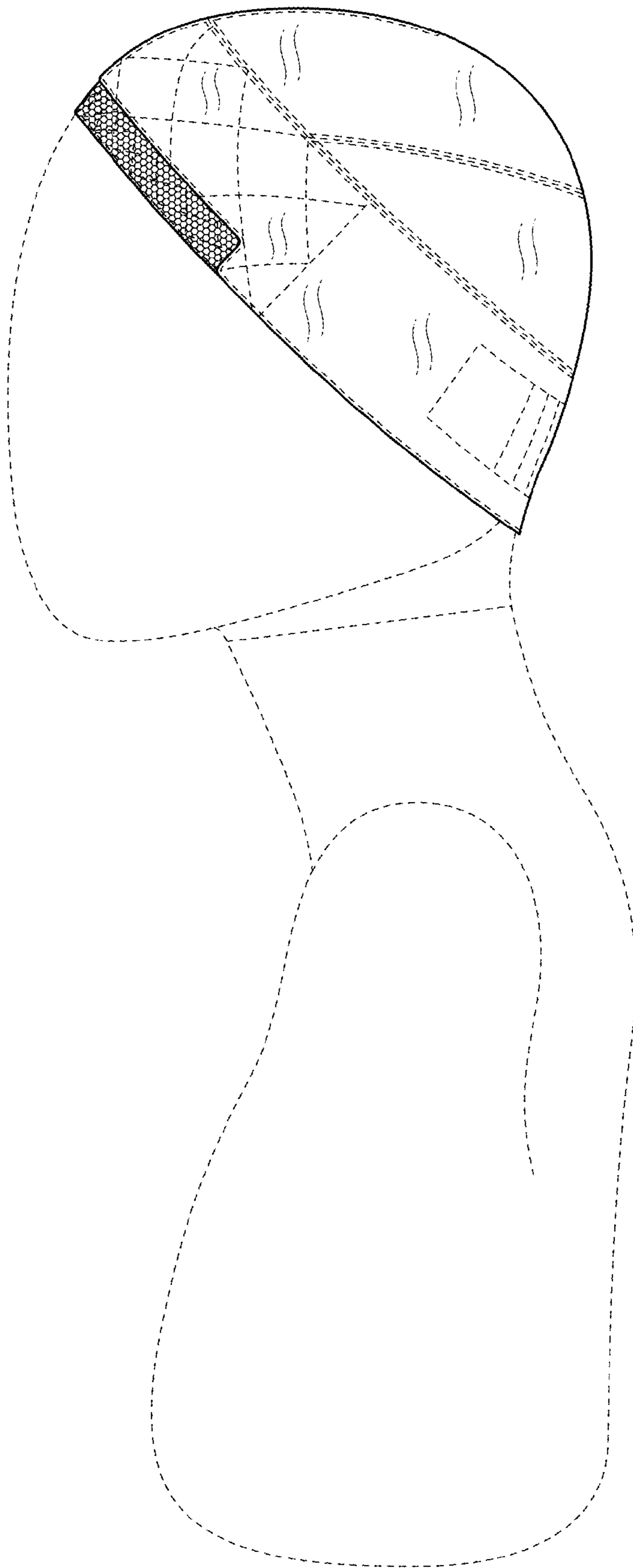

FIG. 4



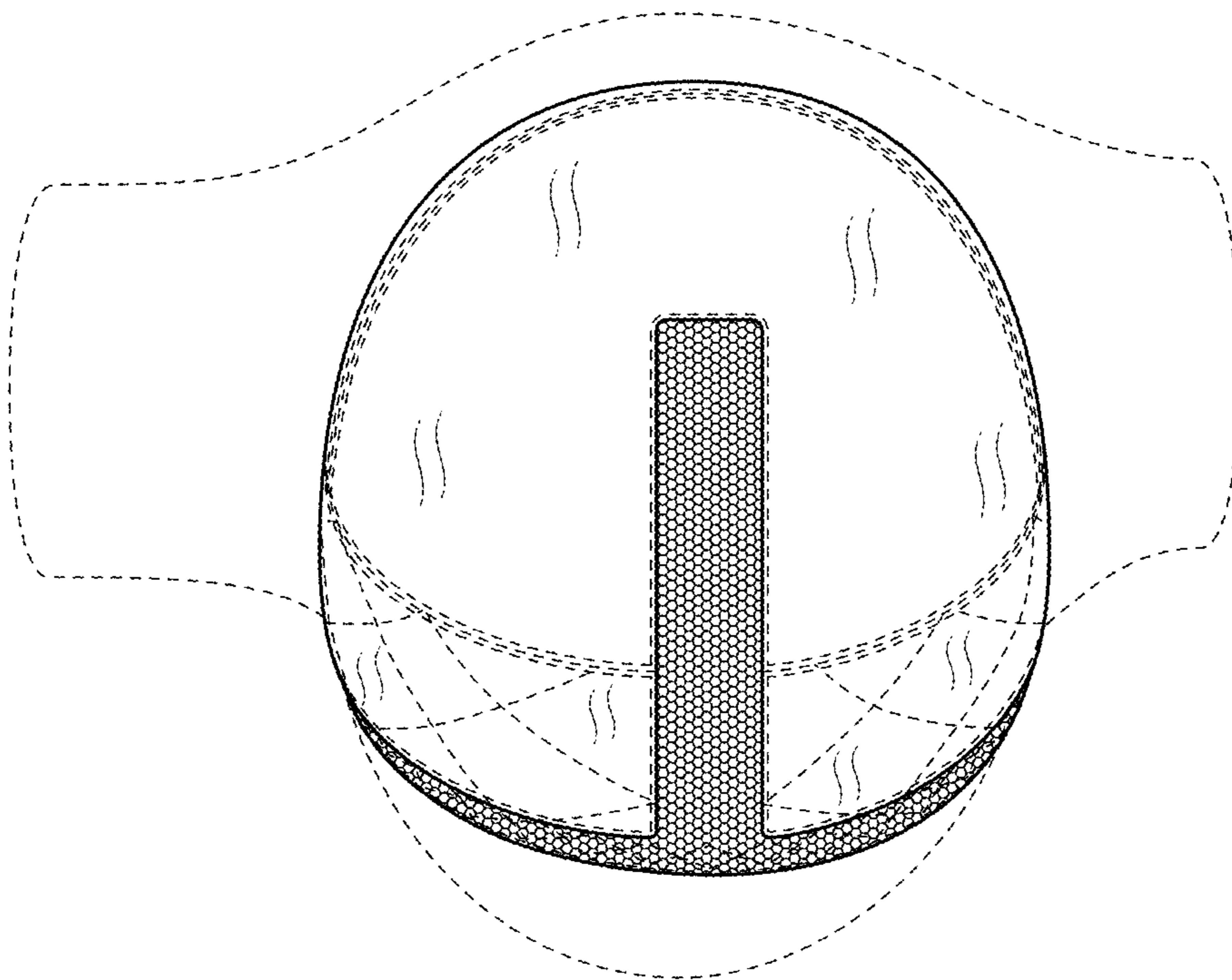

FIG. 5

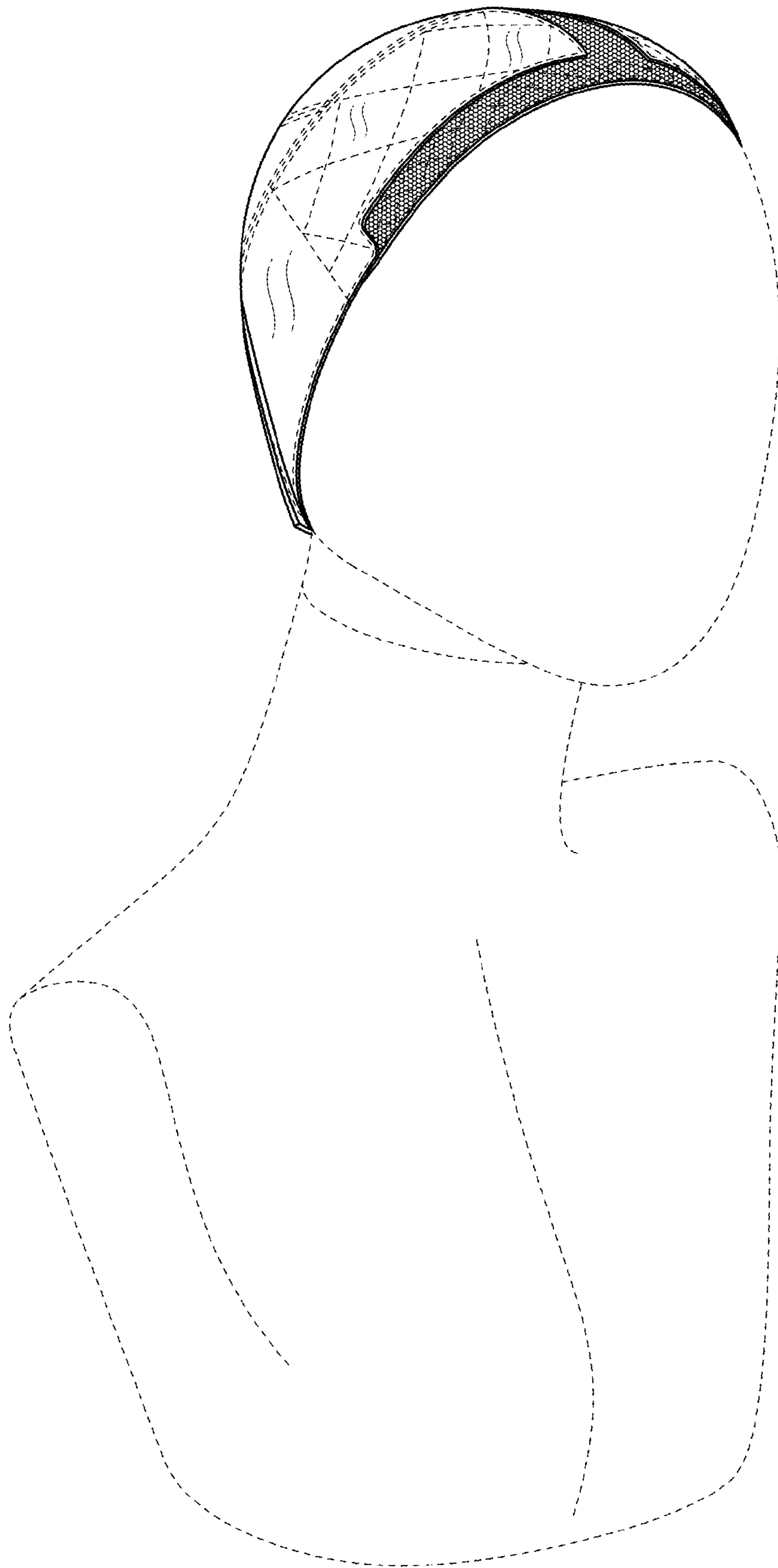

FIG. 6



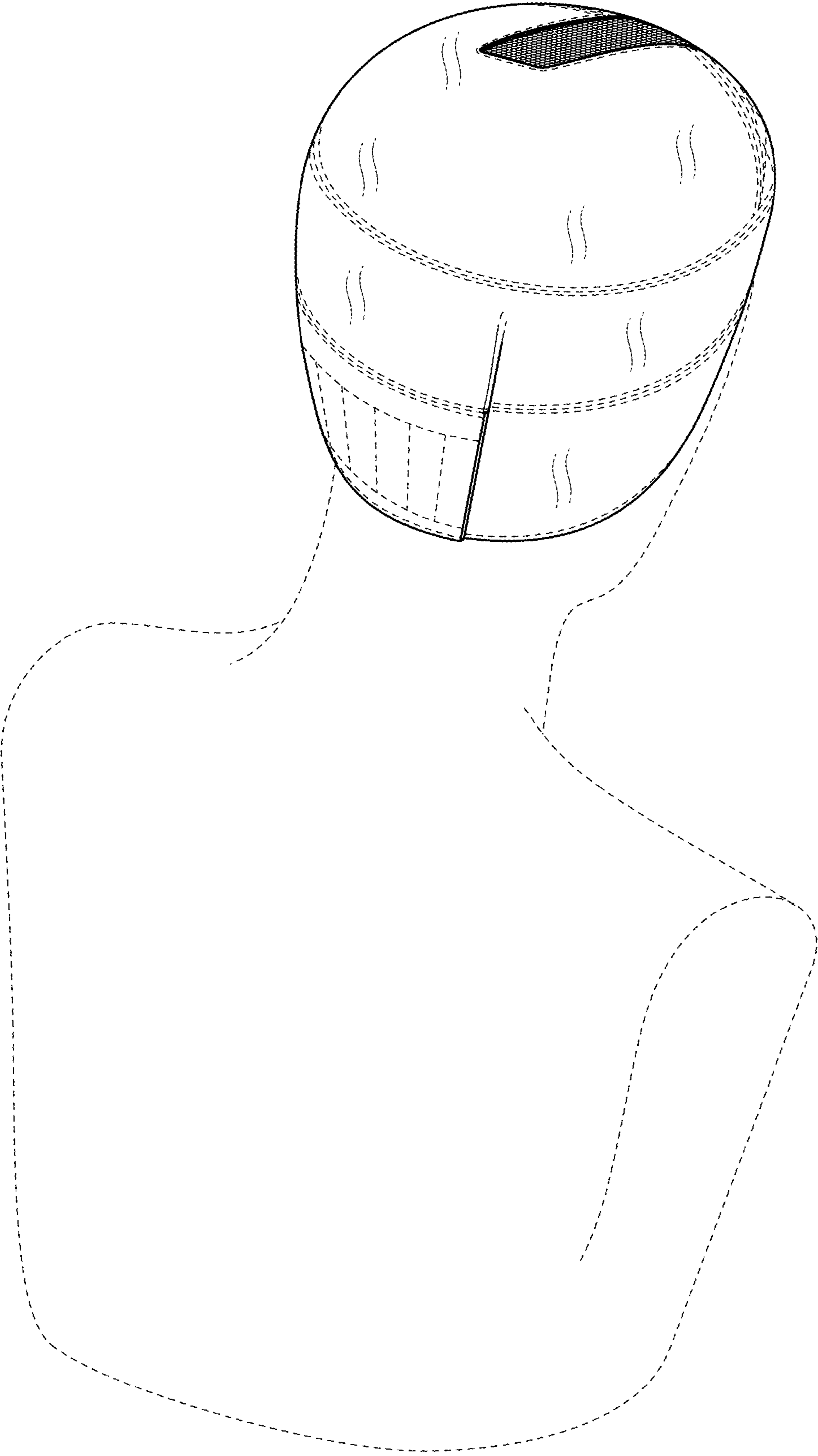

FIG. 7

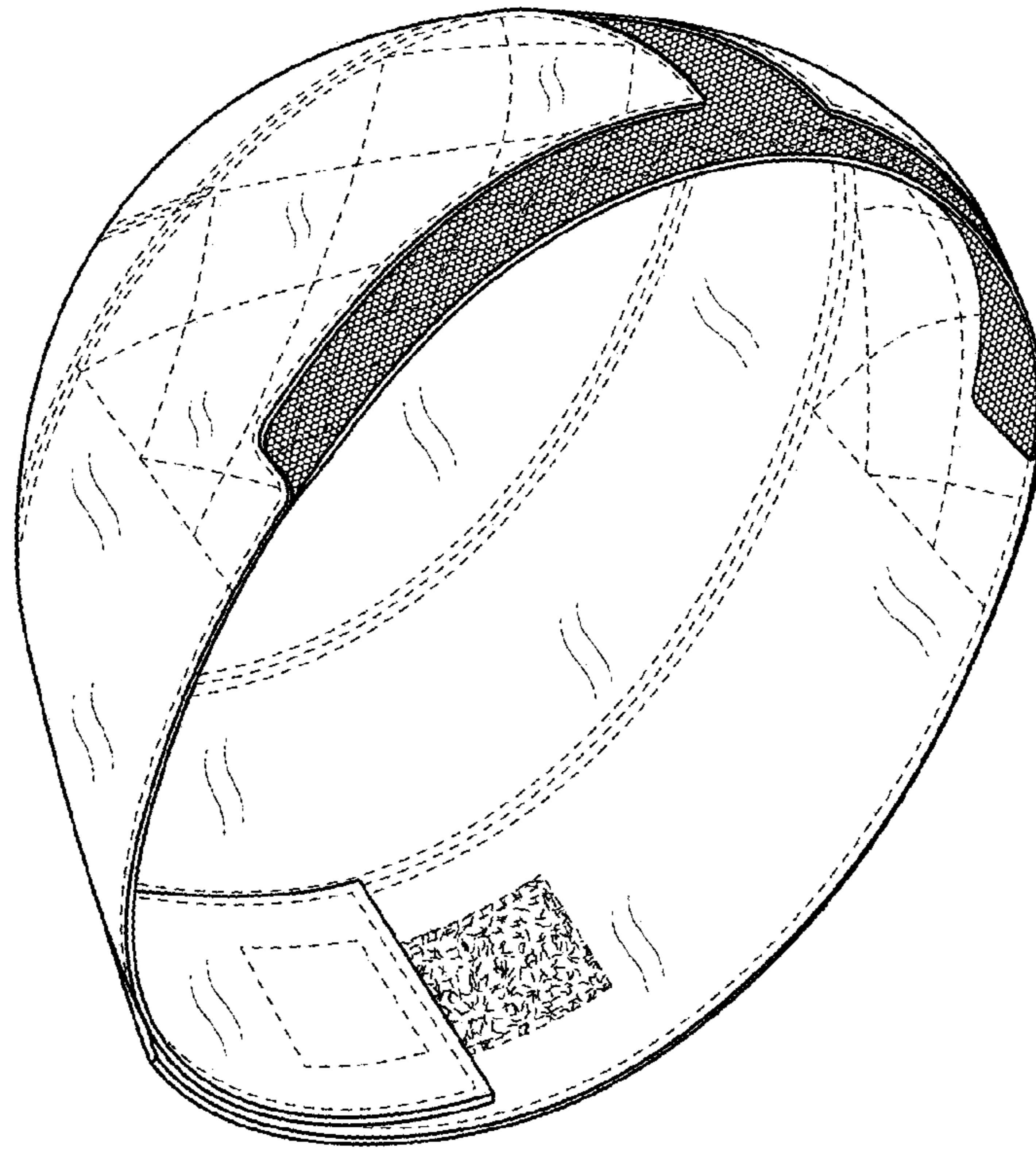

FIG. 8

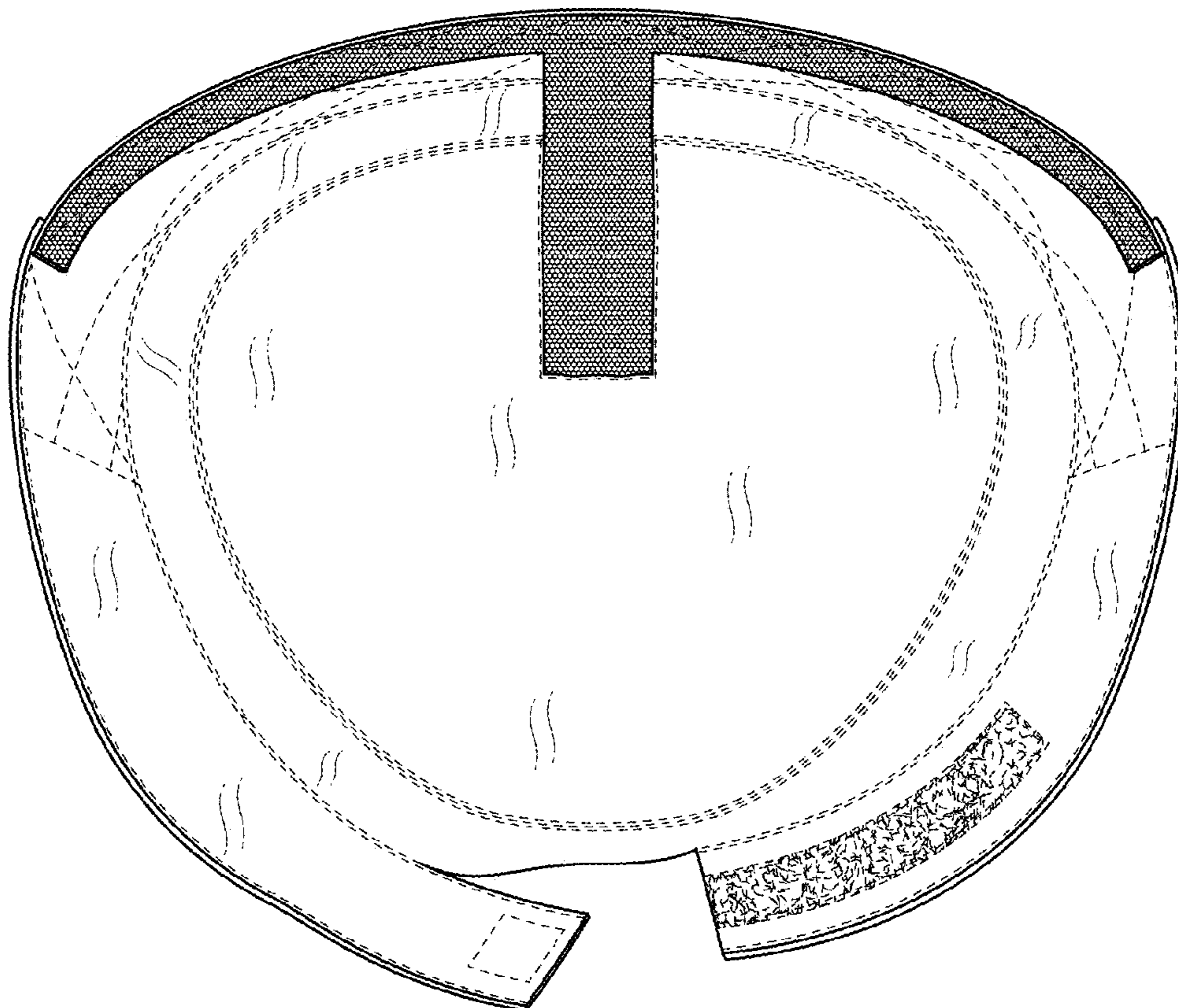

FIG. 9

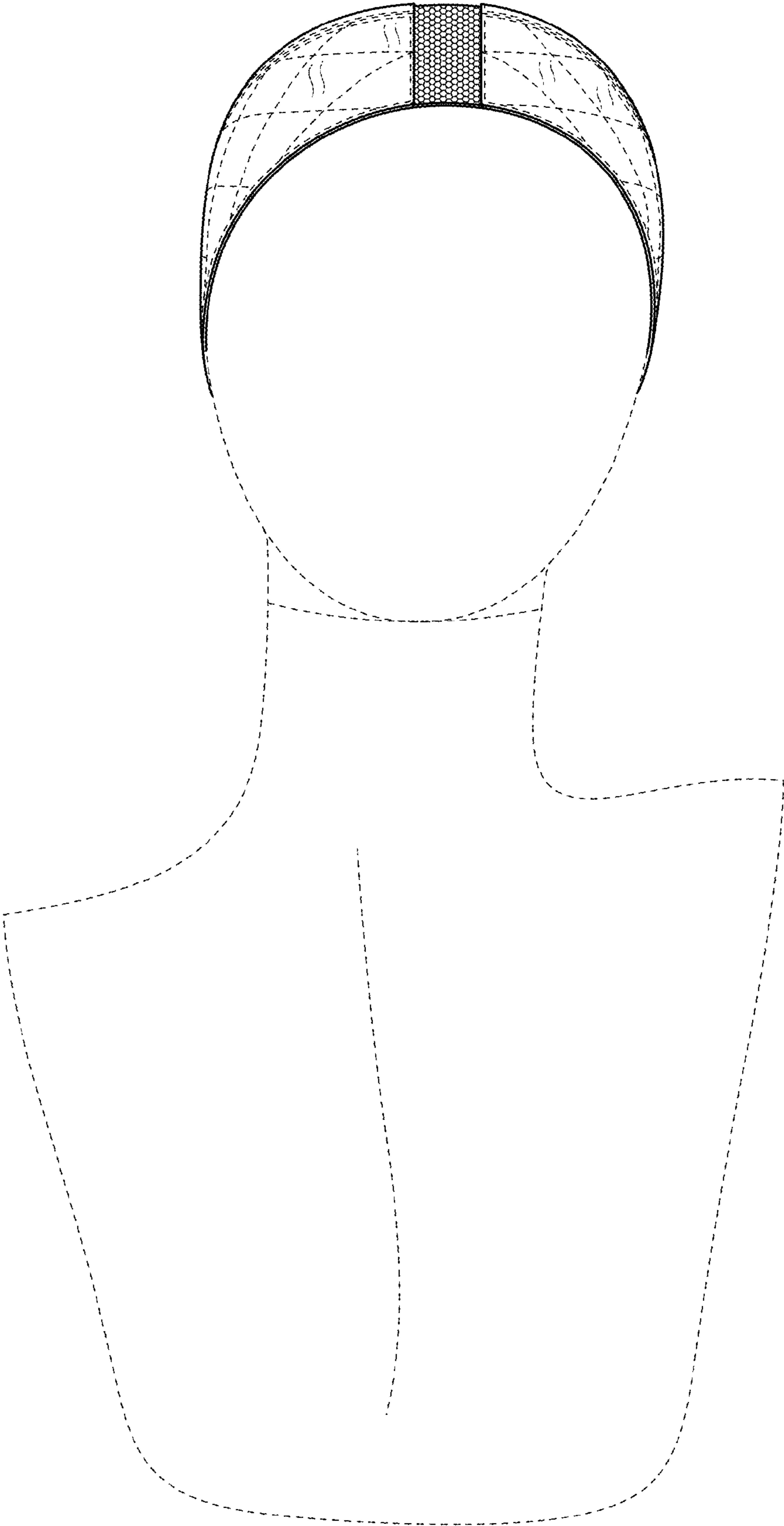

FIG. 10

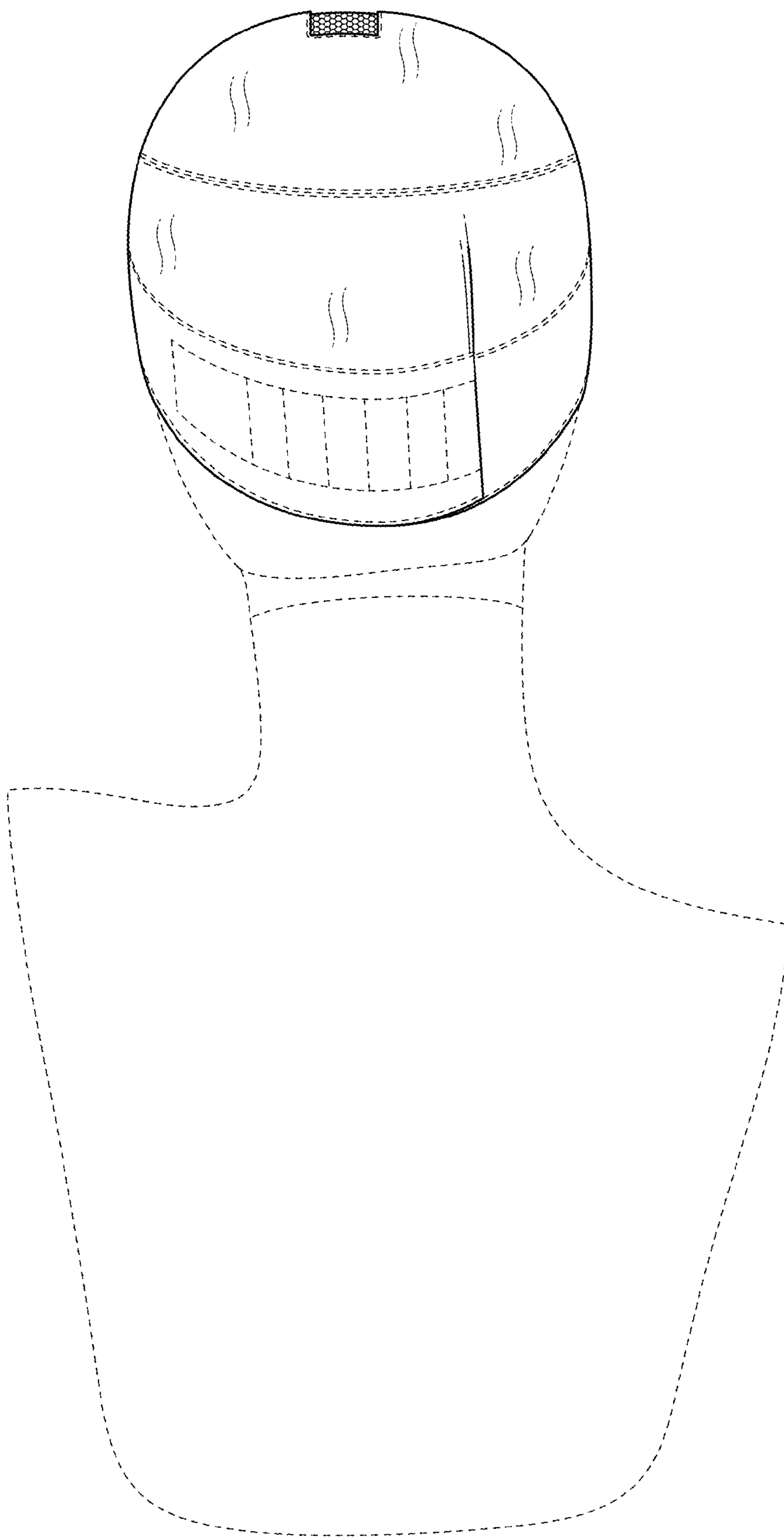

FIG. 11

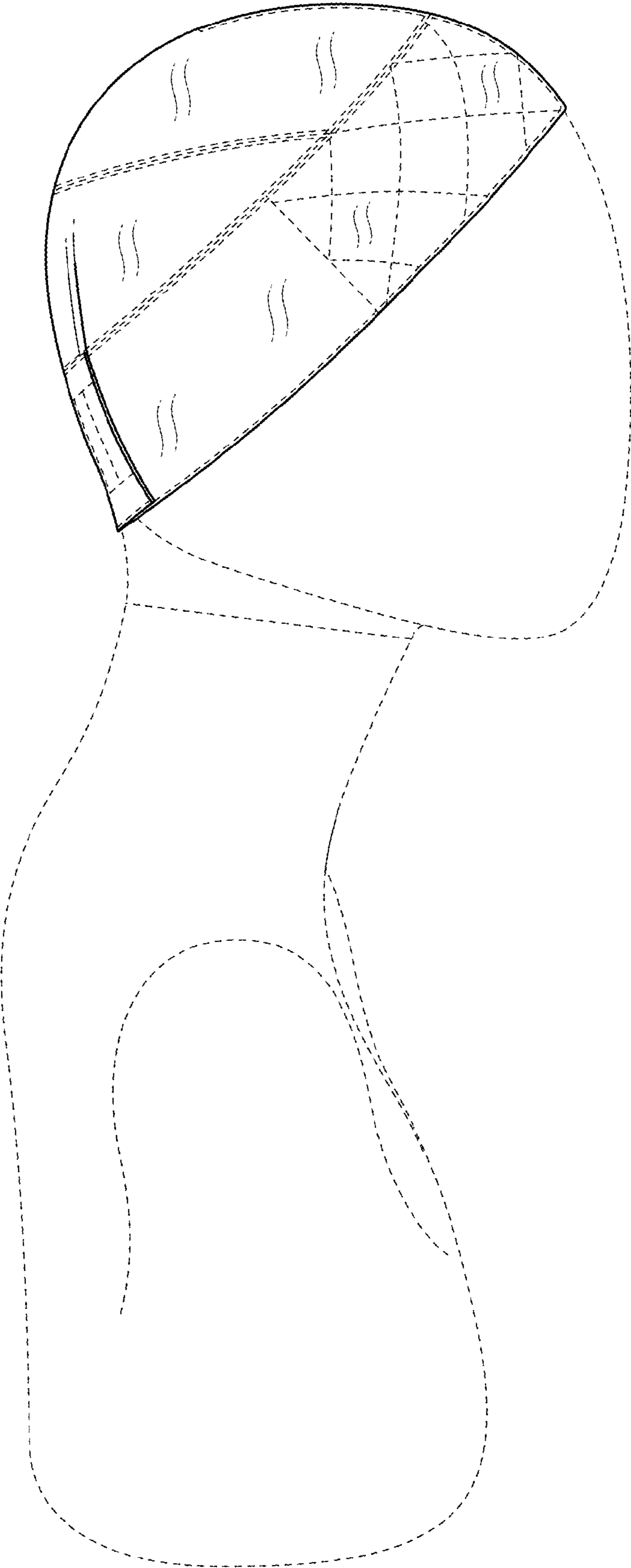

FIG. 12

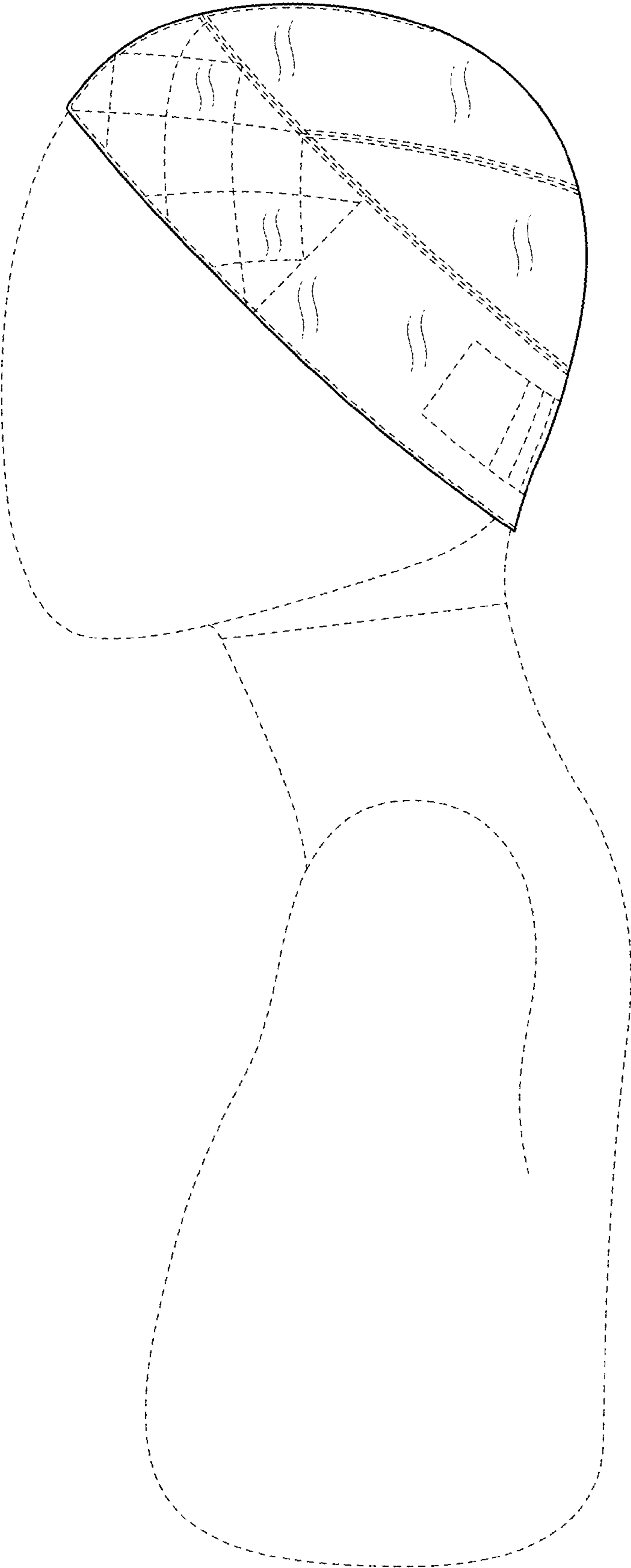

FIG. 13



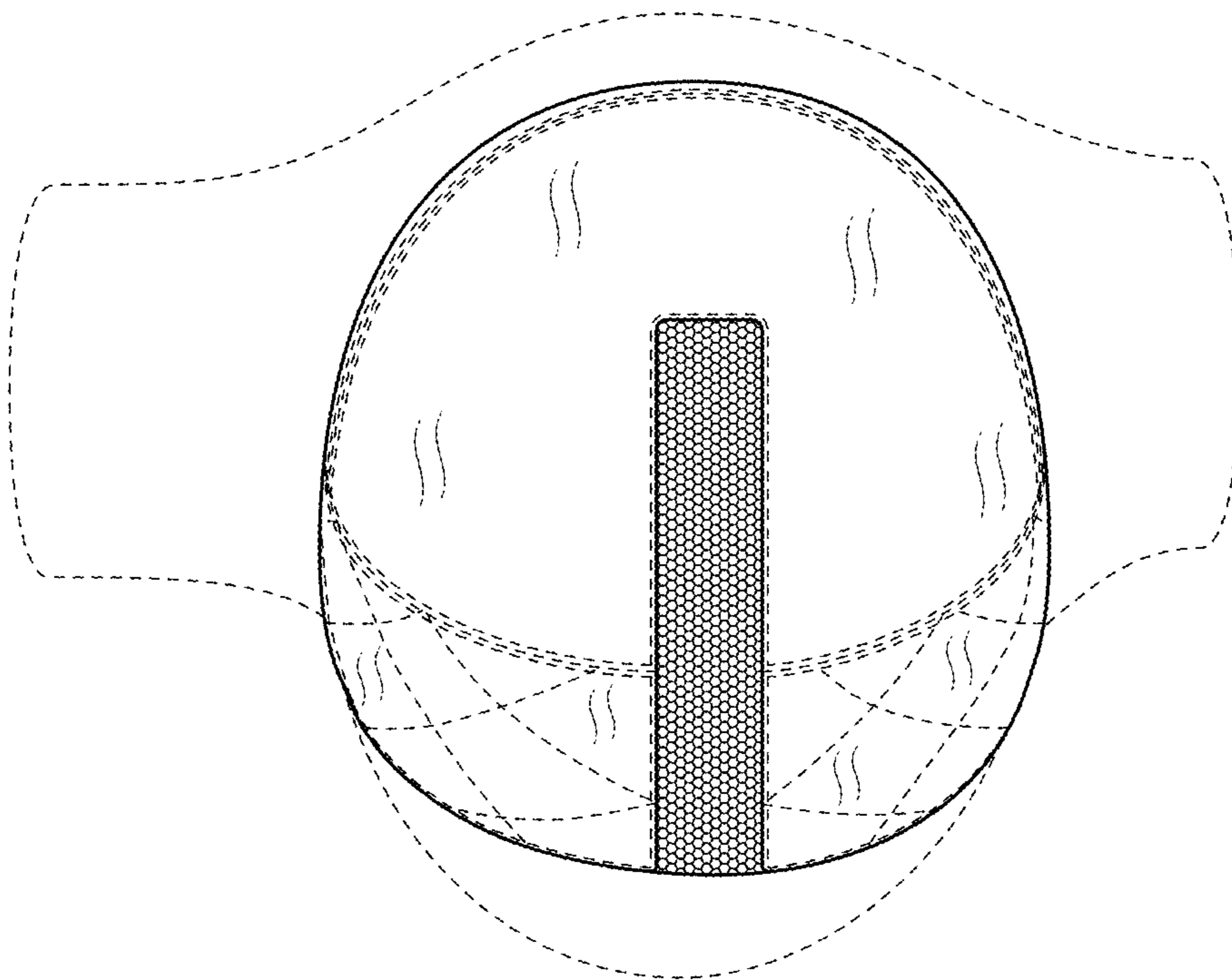

FIG. 14

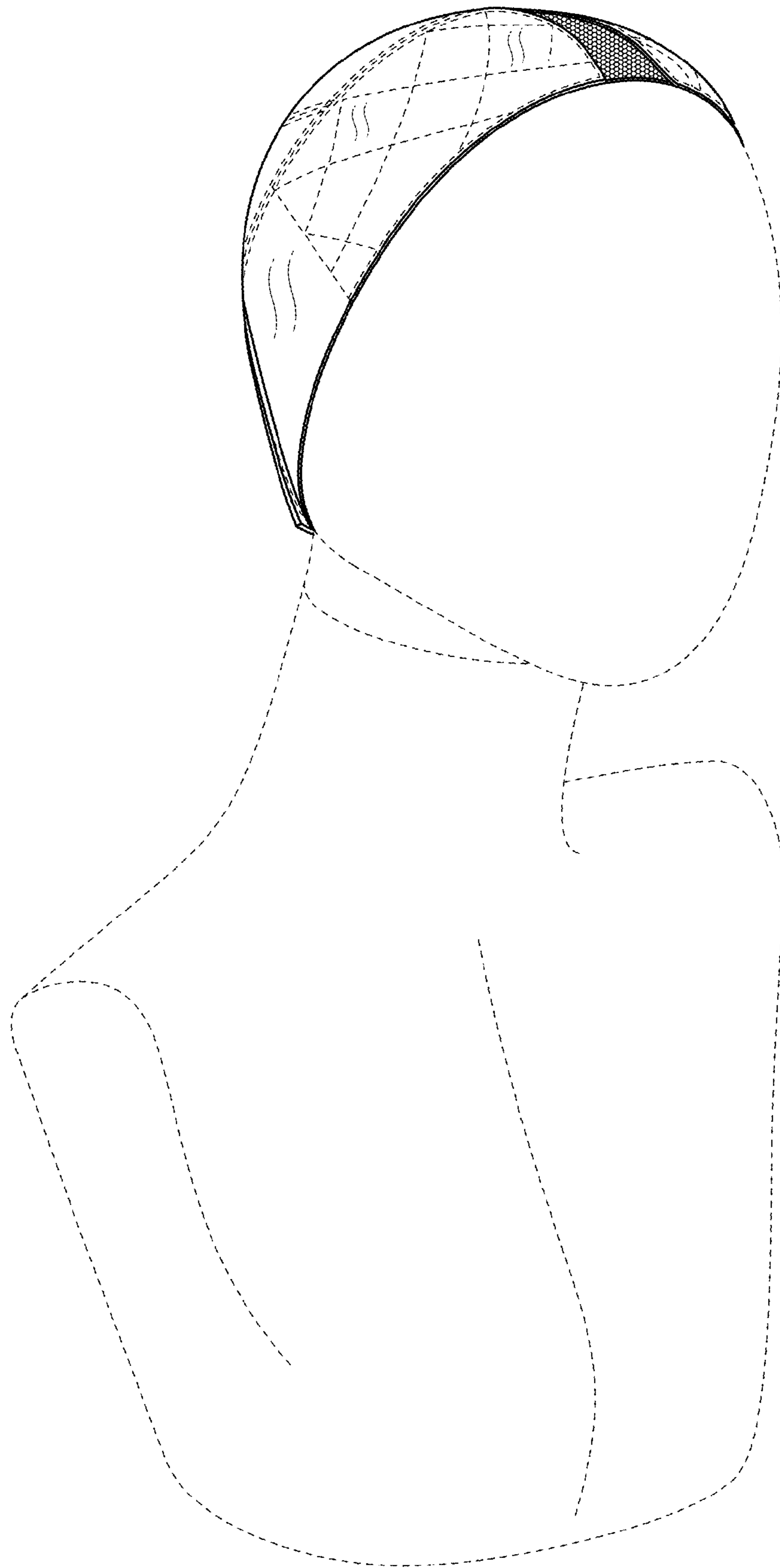

FIG. 15

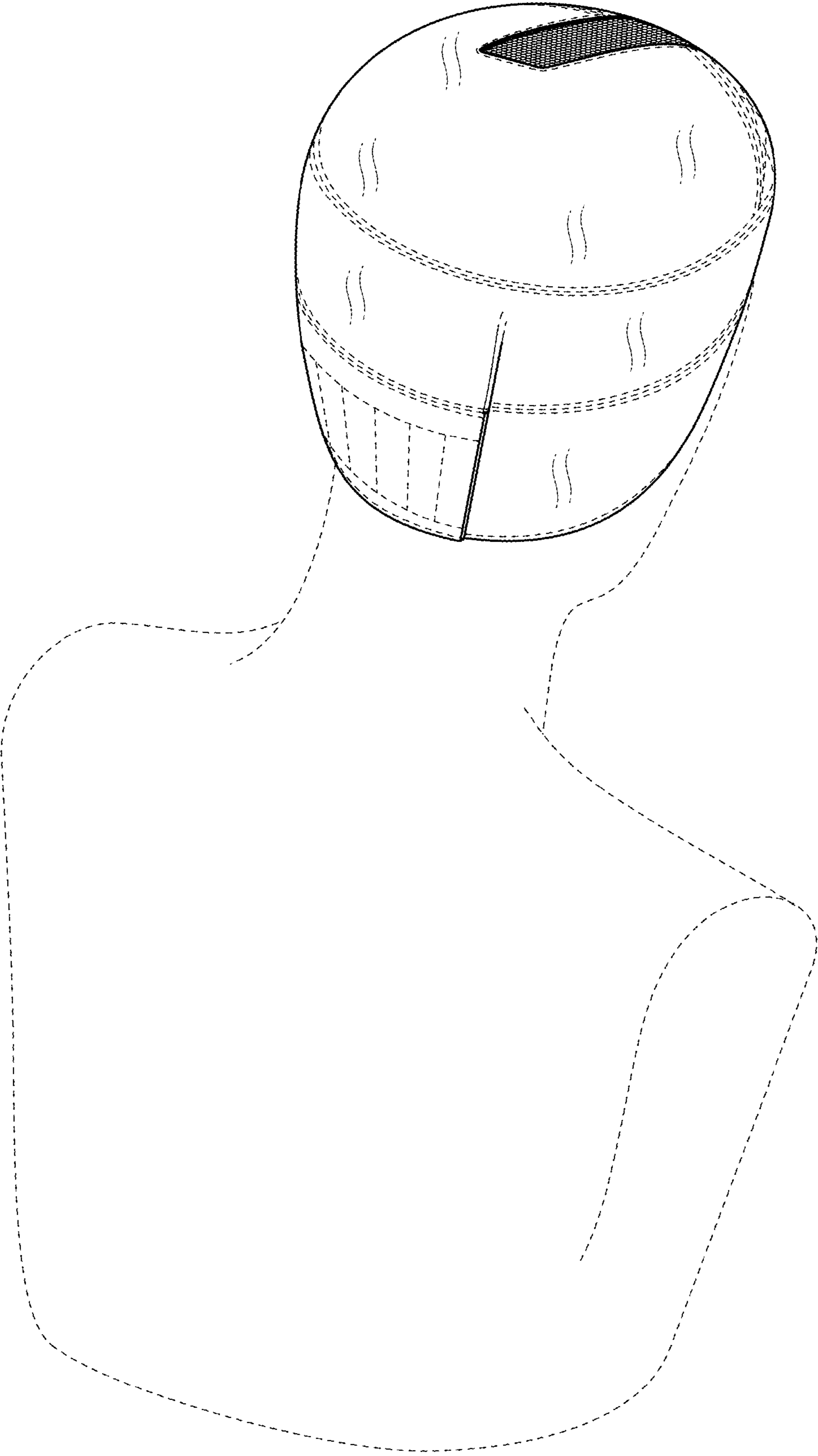

FIG. 16

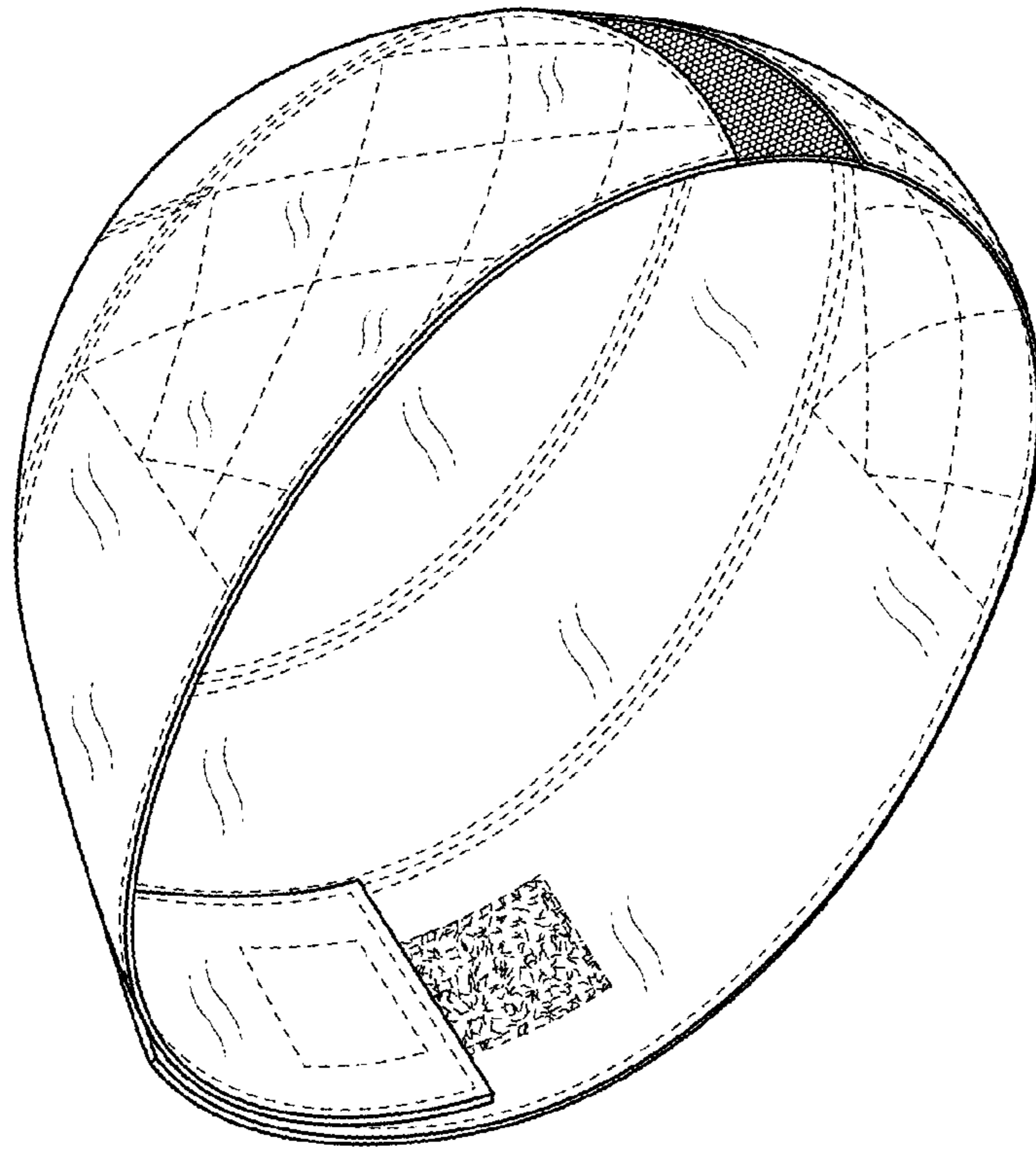

FIG. 17

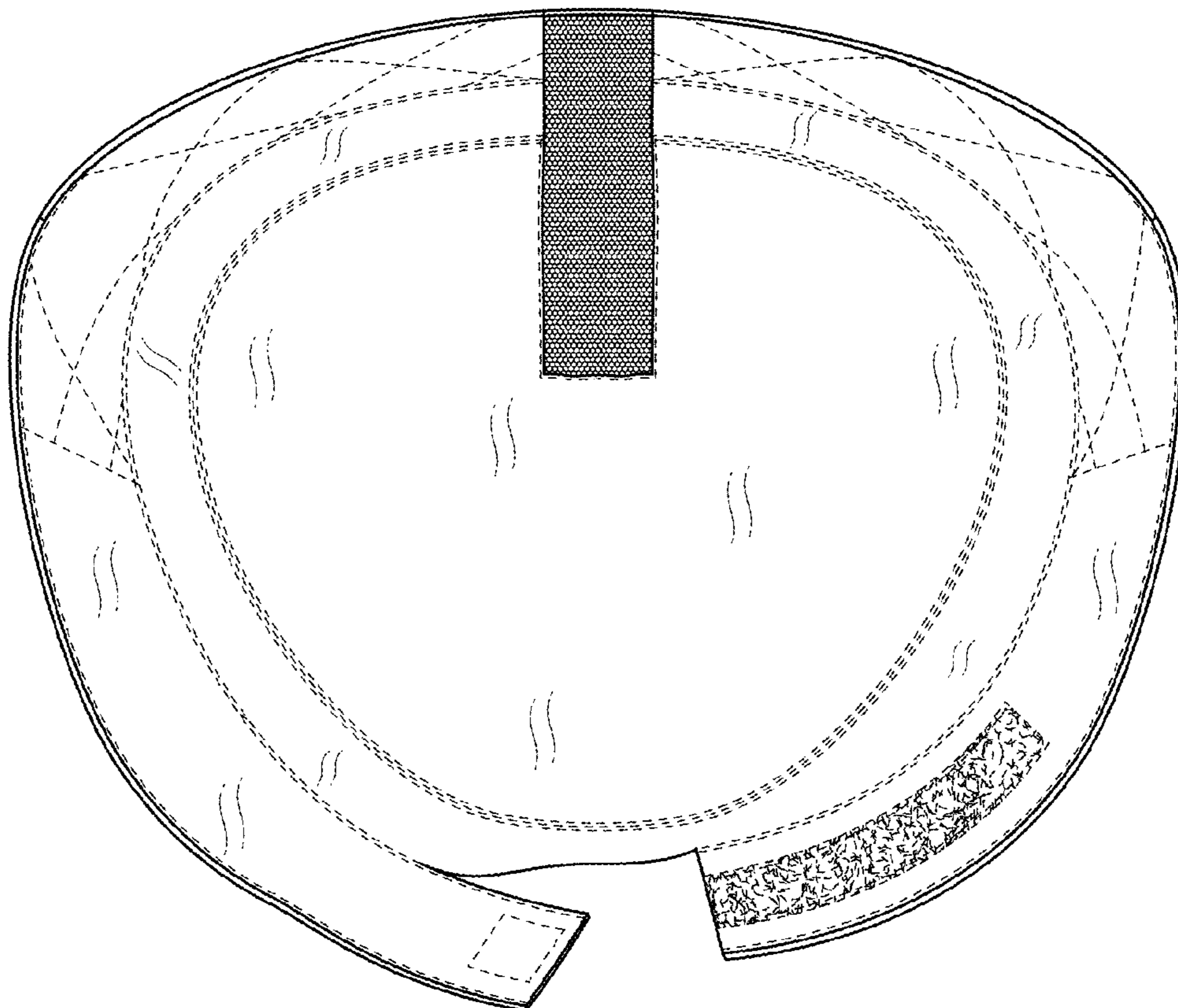

FIG. 18