



US00D939679S

(12) **United States Design Patent**  
**Yoon**

(10) **Patent No.:** **US D939,679 S**

(45) **Date of Patent:** **\*\* Dec. 28, 2021**

(54) **HUMIDIFIER**

(71) Applicant: **WINIX INC.**, Siheung-si (KR)

(72) Inventor: **Chul Min Yoon**, Siheung-si (KR)

(73) Assignee: **WINIX INC.**, Siheung-si (KR)

(\*\*) Term: **15 Years**

(21) Appl. No.: **29/751,395**

(22) Filed: **Sep. 21, 2020**

(30) **Foreign Application Priority Data**

Jun. 3, 2020 (KR) ..... 30-2020-0024698

(51) **LOC (13) Cl.** ..... **23-04**

(52) **U.S. Cl.**  
USPC ..... **D23/356**

(58) **Field of Classification Search**  
USPC ..... D23/355–366, 352, 369, 332, 333, 335,  
D23/336, 342, 351; 422/120, 122;  
55/356, 473, 504; 96/97; 261/DIG. 17,  
261/DIG. 65, DIG. 88, DIG. 31  
CPC .. A61L 9/16; A61L 9/22; B01D 47/00; B01D  
47/027; B01D 2221/02; B01D 2259/4508;  
B03C 3/155; B03C 3/368; F24F 3/16;  
F24F 13/20; F24F 13/28  
See application file for complete search history.

(56) **References Cited**

U.S. PATENT DOCUMENTS

D864,371 S \* 10/2019 Chen ..... D23/366  
D885,548 S \* 5/2020 Cui ..... D23/366  
D910,823 S \* 2/2021 Zou ..... D23/356  
D920,491 S \* 5/2021 Jaanus ..... D23/364

D926,304 S \* 7/2021 Lee ..... D23/366  
D926,305 S \* 7/2021 Lee ..... D23/366  
D929,559 S \* 8/2021 Ren ..... D23/366  
D930,133 S \* 9/2021 Jung ..... D23/364  
D930,137 S \* 9/2021 Lin ..... D23/366  
D930,139 S \* 9/2021 Yang ..... D23/366  
D931,432 S \* 9/2021 Baillie ..... D23/356  
D932,102 S \* 9/2021 Deng ..... D28/44.1  
D933,294 S \* 10/2021 Deng ..... D28/44.1

\* cited by examiner

*Primary Examiner* — David G Muller

(74) *Attorney, Agent, or Firm* — Lewis Roca Rothgerber  
Christie LLP

(57) **CLAIM**

The ornamental design for a humidifier, as shown and described.

**DESCRIPTION**

FIG. 1 is a front, top, and right side perspective view of a humidifier;  
FIG. 2 is a front elevational view of the humidifier of FIG. 1;  
FIG. 3 is a rear elevational view of the humidifier of FIG. 1;  
FIG. 4 is a left side elevational view of the humidifier of FIG. 1;  
FIG. 5 is a right side elevational view of the humidifier of FIG. 1;  
FIG. 6 is a top plan view of the of the humidifier of FIG. 1;  
and,  
FIG. 7 is a bottom plan view of the humidifier of FIG. 1.  
The broken lines in the drawings are for the purpose of illustrating portions of the humidifier that form no part of the claimed design.

**1 Claim, 7 Drawing Sheets**

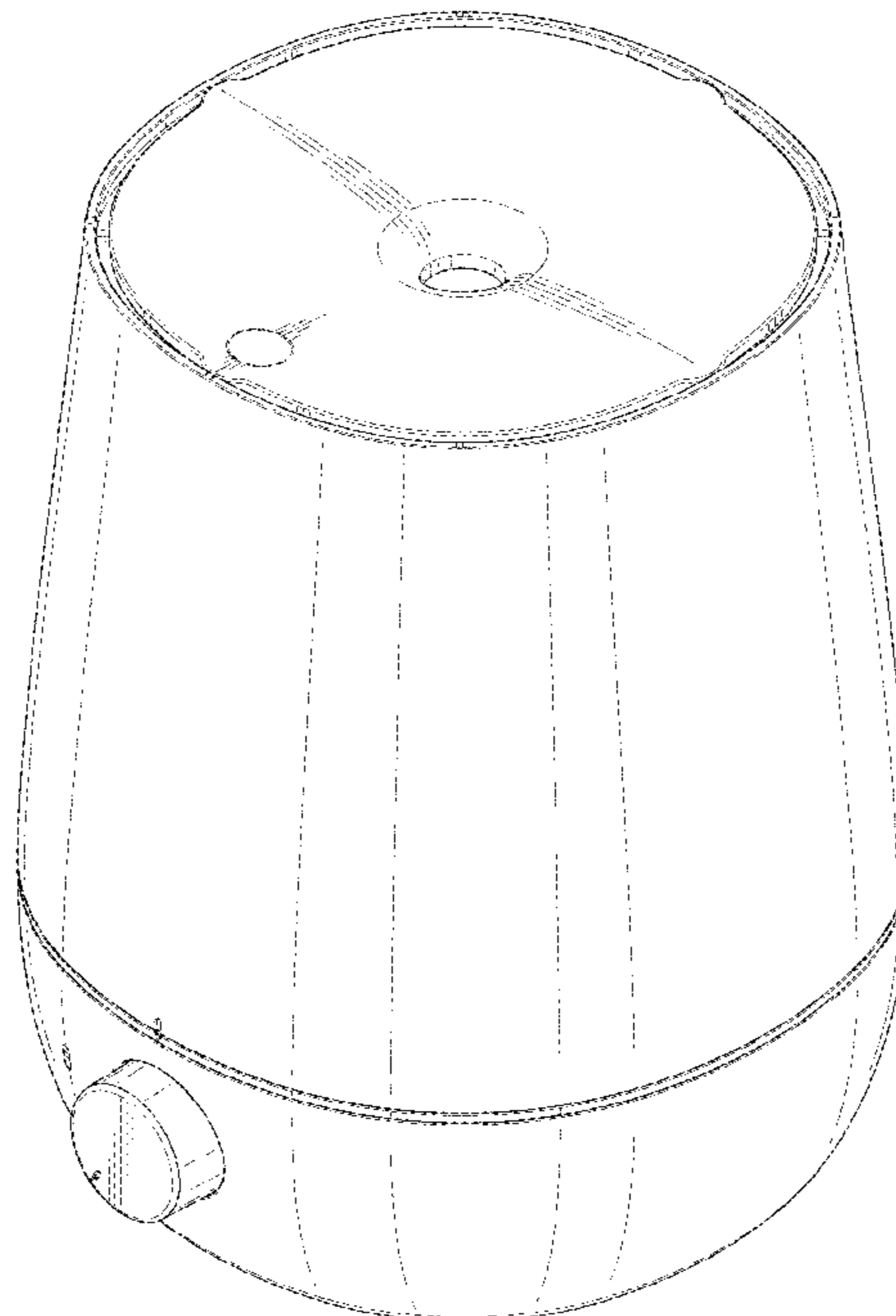

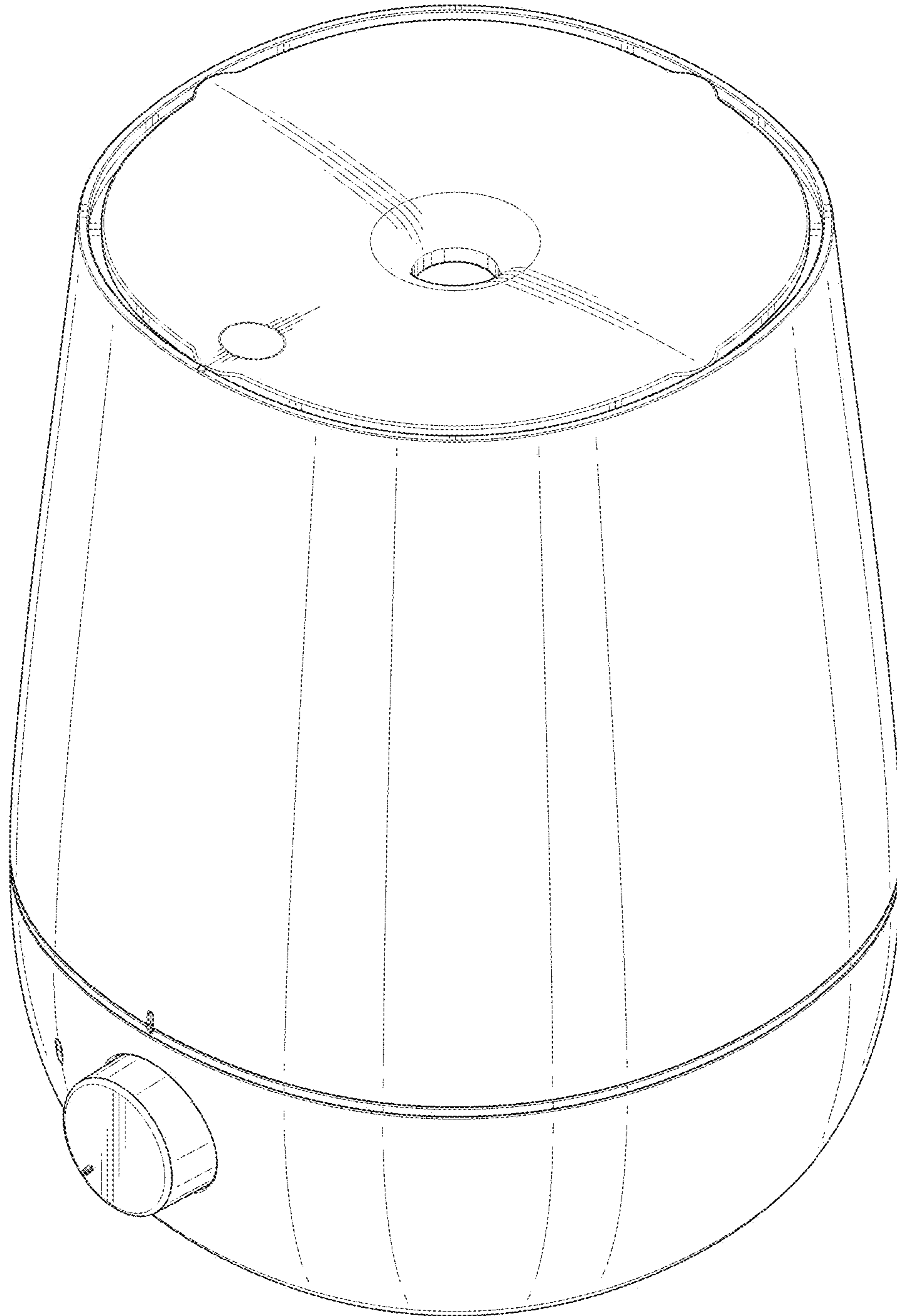

FIG. 1

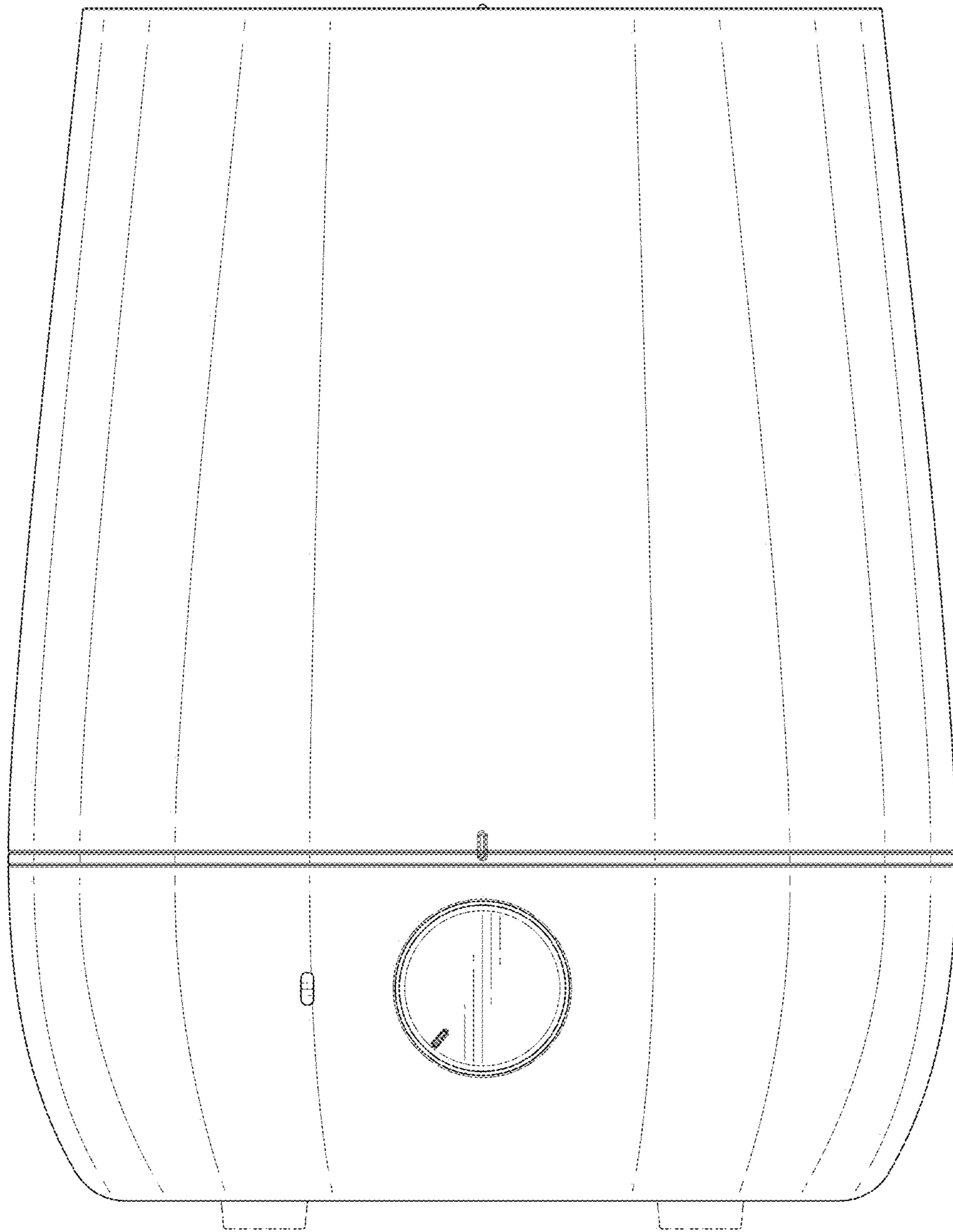

FIG. 2

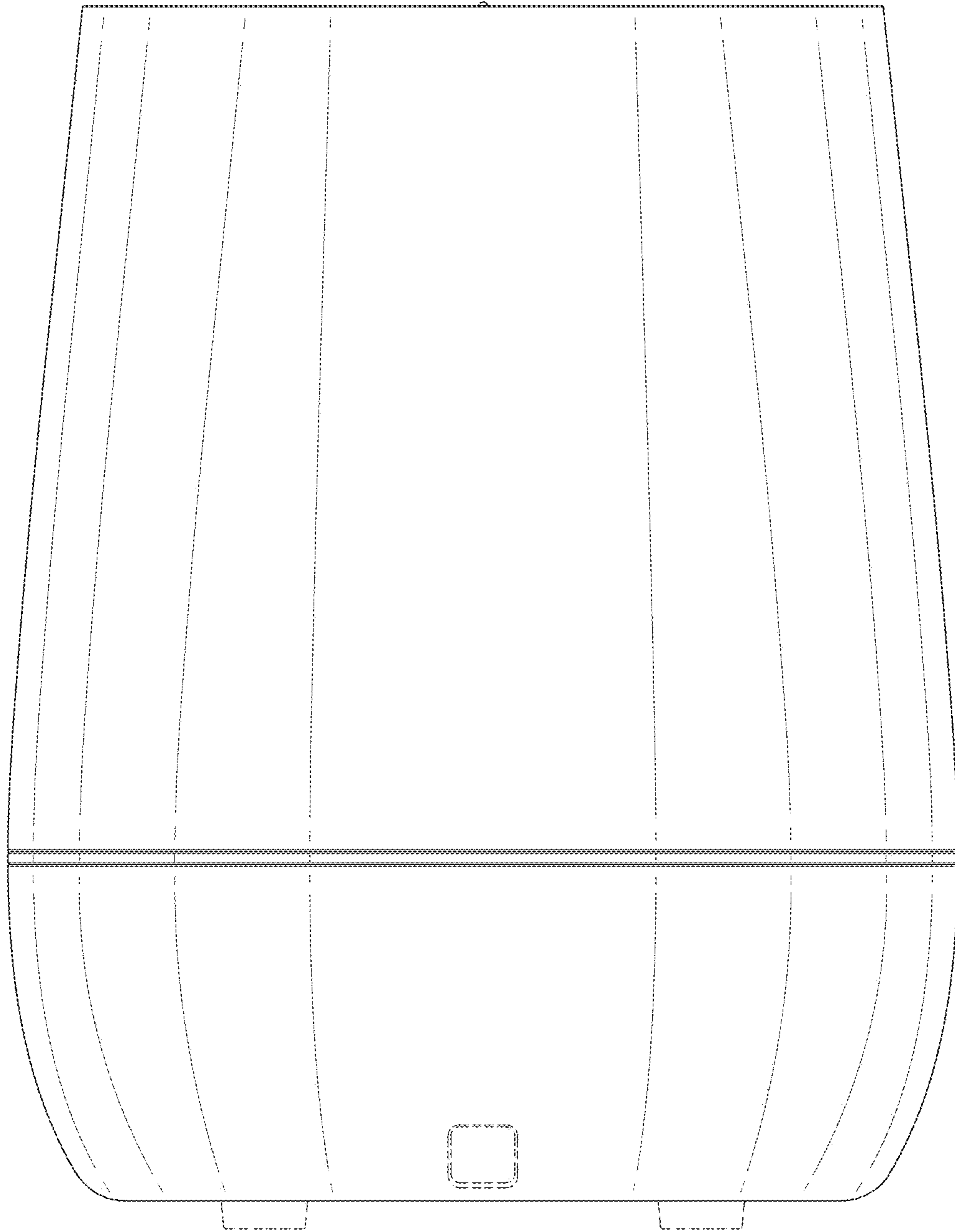

FIG. 3

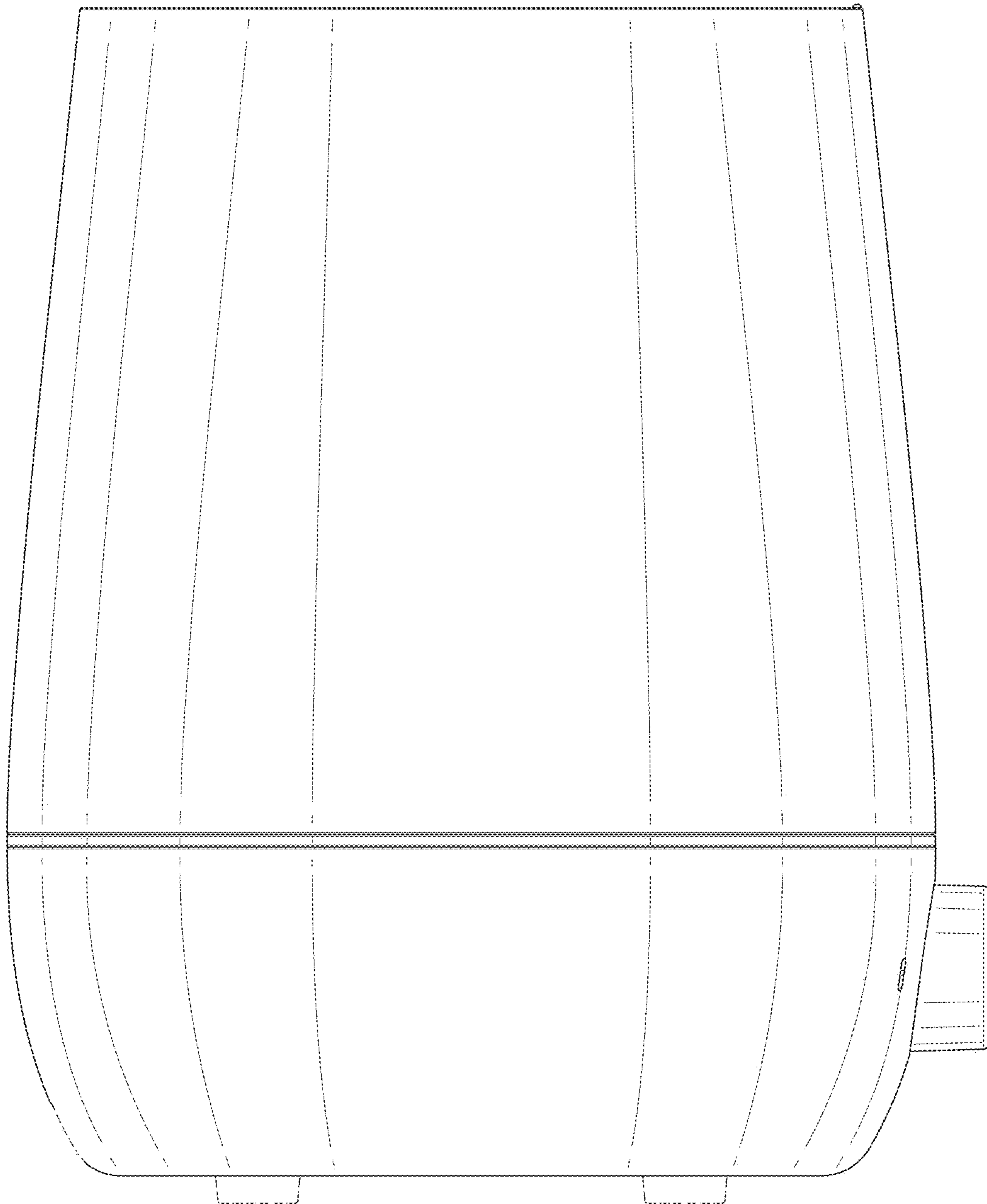

FIG. 4

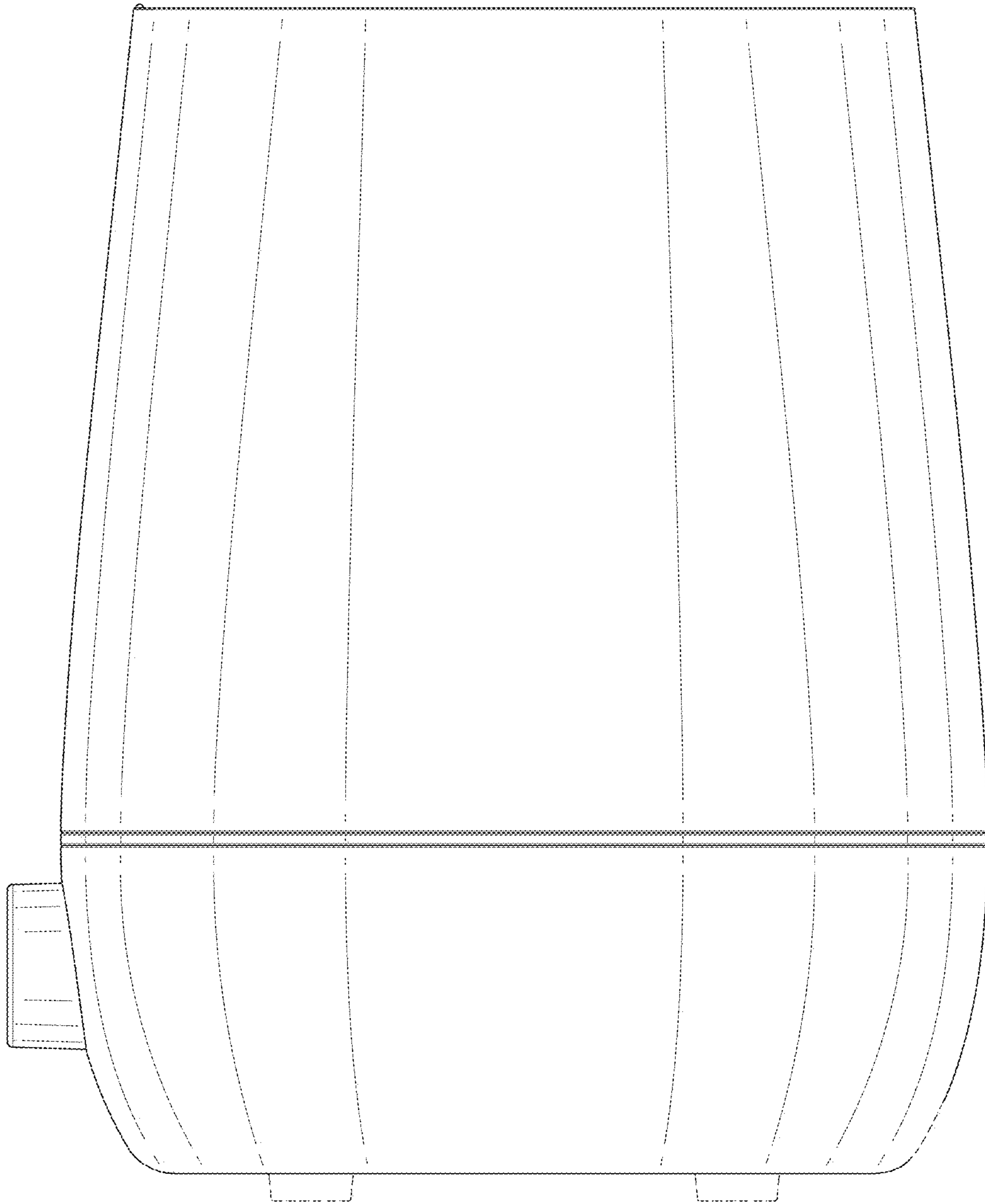

FIG. 5

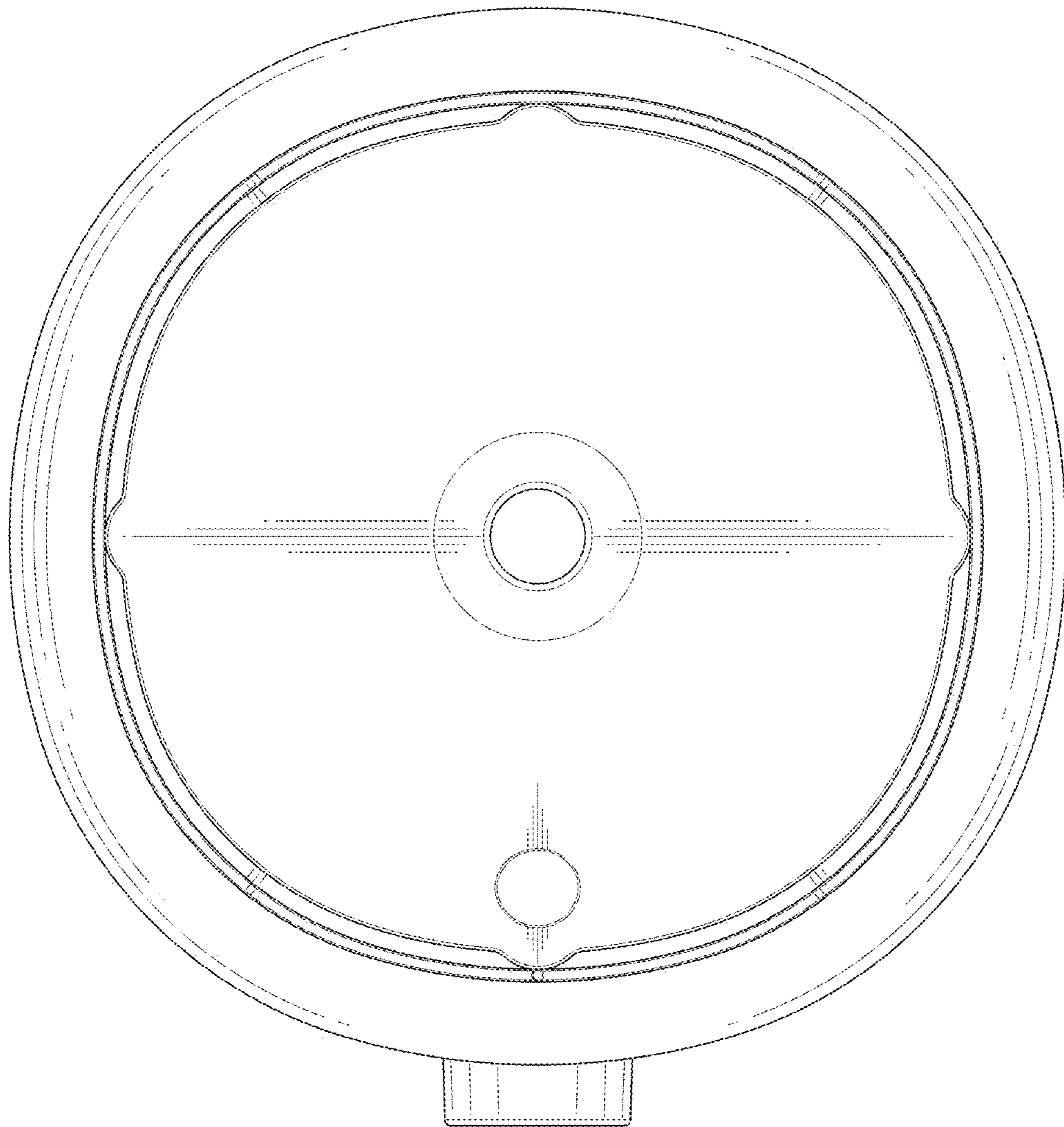

FIG. 6

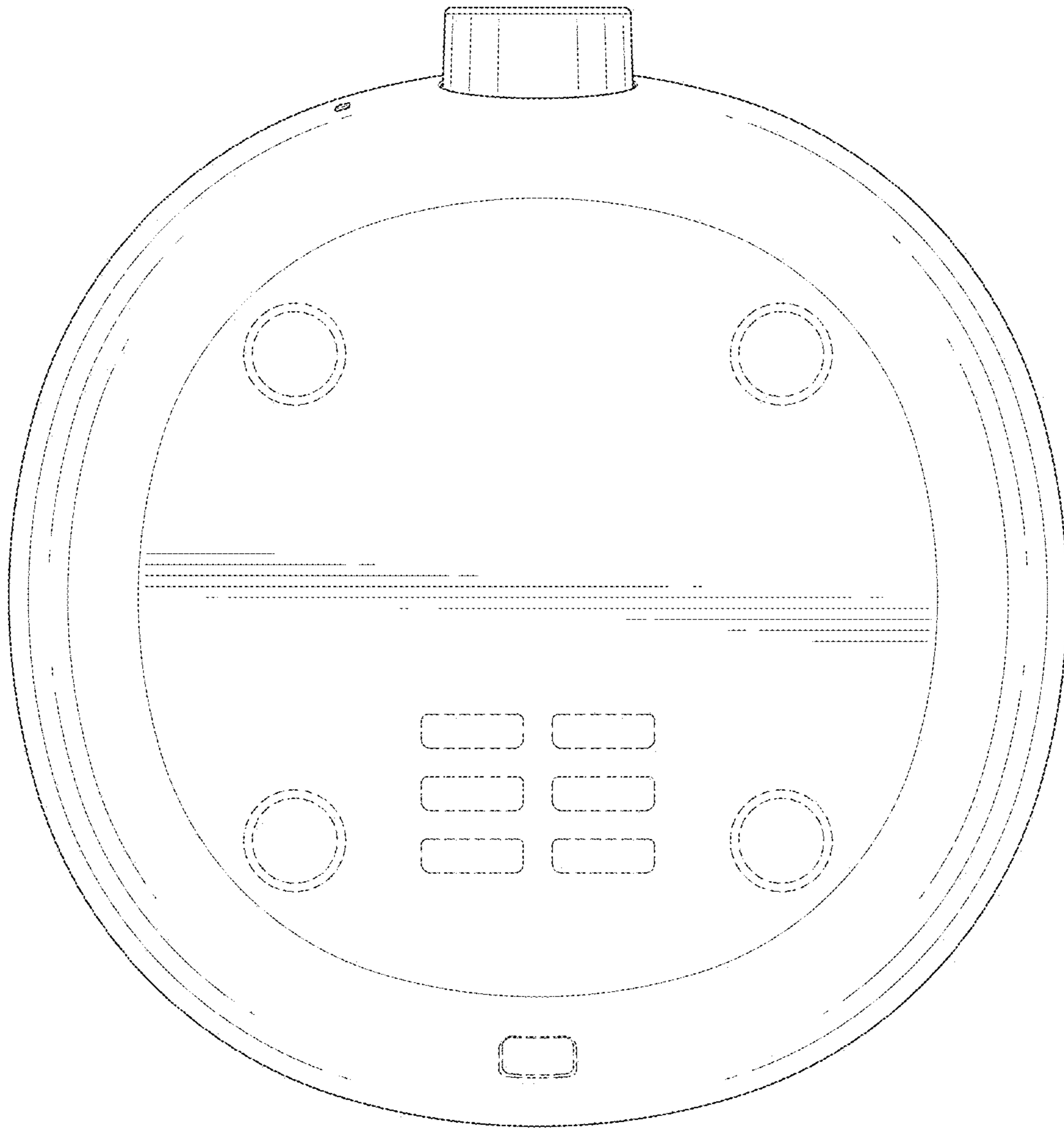

FIG. 7