



US00D939632S

(12) **United States Design Patent** (10) **Patent No.:** **US D939,632 S**  
**Lewis et al.** (45) **Date of Patent:** **\*\* Dec. 28, 2021**

(54) **GAMING MACHINE**

(71) Applicant: **AGS LLC**, Las Vegas, NV (US)

(72) Inventors: **Rachel Calhoun Lewis**, Atlanta, GA (US); **Mark Robert Brandau**, Johns Creek, GA (US); **Sigmund Hyunjai Lee**, Atlanta, GA (US); **Kevin Lee Hohman**, North Las Vegas, NV (US); **James Ely Tillery**, Atlanta, GA (US); **Wei Gu**, Daly City, CA (US); **Ariel David Turgel**, San Francisco, CA (US); **Daniel Kendall Harden**, Palo Alto, CA (US)

(73) Assignee: **AGS LLC**, Las Vegas, NV (US)

(\*\*) Term: **15 Years**

(21) Appl. No.: **29/656,949**

(22) Filed: **Jul. 17, 2018**

(51) **LOC (13) Cl.** ..... **21-03**

(52) **U.S. Cl.**  
 USPC ..... **D21/370**

(58) **Field of Classification Search**  
 USPC ..... D21/349, 350, 397, 329, 332, 333, 365, D21/385, 694, 371, 325, 324, 336, 369, D21/370  
 CPC .... A63F 7/027; A63F 9/00; A63F 5/04; A63F 7/02; G07F 17/321; G07F 17/3213  
 See application file for complete search history.

D307,771 S	5/1990	Cesaroni et al.
5,057,827 A	10/1991	Nobile et al.
5,108,099 A	4/1992	Smyth
D326,254 S	5/1992	Ziaylek et al.
5,113,990 A	5/1992	Gabrius et al.
D333,164 S	2/1993	Kraft et al.
D336,134 S	6/1993	Kalatsky
5,302,965 A	4/1994	Belcher et al.
5,381,502 A	1/1995	Veligdan
D357,684 S	4/1995	Moreland
5,432,967 A	7/1995	Raftery
5,521,587 A	5/1996	Sawabe et al.
D373,809 S	9/1996	Hirato
5,561,346 A	10/1996	Byrne
D380,014 S	6/1997	Yang
D381,697 S	7/1997	Brettschneider
D381,700 S	7/1997	Brettschneider
5,670,971 A	9/1997	Tokimoto et al.
D386,796 S	11/1997	Komori
D387,656 S	12/1997	Liang
5,695,402 A	12/1997	Stupak
D398,304 S	9/1998	Murray et al.
D398,605 S	9/1998	Murray et al.
5,813,914 A	9/1998	McKay et al.
5,818,401 A	10/1998	Wang
5,826,882 A	10/1998	Ward
5,836,819 A	11/1998	Ugawa
D406,718 S	3/1999	Jacobs
D407,758 S	4/1999	Isetani et al.
D413,635 S	9/1999	Taylor
D414,526 S	9/1999	Kashani
D421,631 S	3/2000	Tsuda
D424,122 S	5/2000	Dickenson et al.
6,068,101 A	5/2000	Dickenson et al.
D428,062 S	7/2000	Hayashi
6,095,526 A	8/2000	Jack
6,135,884 A	10/2000	Hedrick et al.
6,164,645 A	12/2000	Weiss
D436,380 S	1/2001	Brettschneider
6,176,584 B1	1/2001	Best et al.
6,183,109 B1	2/2001	Nelson et al.
6,186,645 B1	2/2001	Camarota
6,201,703 B1	3/2001	Yamada et al.
D439,931 S	4/2001	Yamaguchi
D442,640 S	5/2001	Hayashi
6,265,984 B1	7/2001	Molinarioli
D446,252 S	8/2001	Yamaguchi
6,278,419 B1	8/2001	Malkin
6,283,608 B1	9/2001	Straat
6,319,125 B1	11/2001	Acres
6,332,690 B1	12/2001	Murofushi
6,334,612 B1	1/2002	Wurz et al.
D459,402 S	6/2002	Wurz et al.

(56) **References Cited**

U.S. PATENT DOCUMENTS

1,692,064 A	11/1928	Trogner
2,023,356 A	12/1935	Fain
4,440,457 A	4/1984	Fogelman et al.
D275,117 S	8/1984	Heywood
4,781,271 A	11/1988	Wokeck
4,831,345 A	5/1989	Schiavone
4,844,567 A	7/1989	Chalabian
4,917,219 A	4/1990	Henry
4,918,579 A	4/1990	Bennett

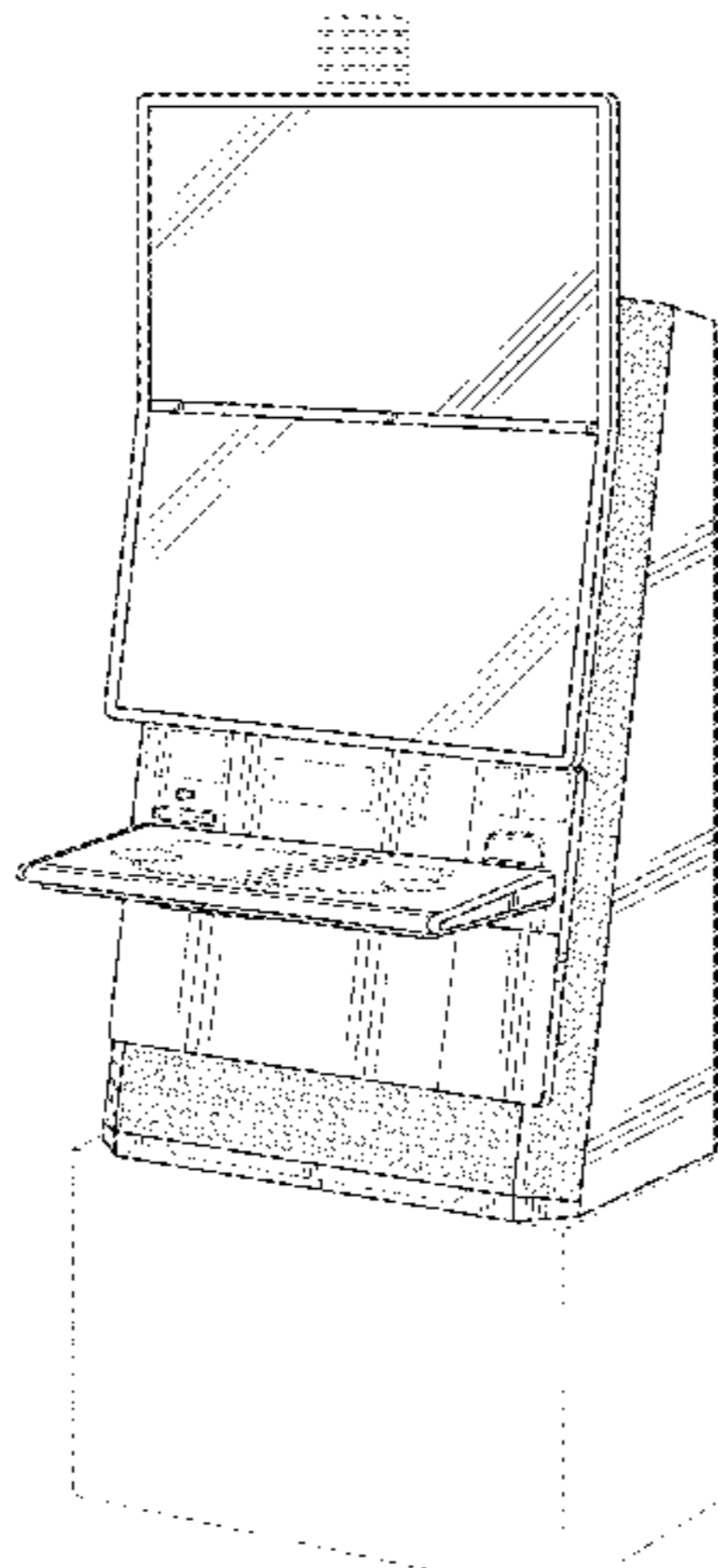

# US D939,632 S

D460,915 S	7/2002	Lynch	D626,182 S	10/2010	Cole et al.
6,443,837 B1	9/2002	Jaffe et al.	D626,183 S	10/2010	Cole et al.
D464,377 S	10/2002	Wurz et al.	7,826,006 B2	11/2010	Koganezawa
D466,160 S	11/2002	Hirato et al.	7,828,461 B2	11/2010	Mayer et al.
6,475,087 B1	11/2002	Cole	7,833,102 B2	11/2010	Beadell et al.
D471,594 S	3/2003	Nojo	7,862,436 B2	1/2011	Cole
6,577,286 B1	6/2003	Jang	D633,950 S	3/2011	Terpsta et al.
6,578,847 B1	6/2003	Hedrick et al.	7,927,218 B2	4/2011	Kopera et al.
6,579,174 B1	6/2003	Lane et al.	7,966,485 B2	6/2011	Chen et al.
6,592,238 B2	7/2003	Cleaver et al.	D646,336 S	10/2011	Kelly et al.
6,641,484 B2	11/2003	Oles et al.	D649,605 S	11/2011	Terpstra et al.
6,678,919 B1	1/2004	Sokolov et al.	8,054,243 B2	11/2011	Sokolov et al.
6,682,418 B1	1/2004	Mendes et al.	8,075,385 B2	12/2011	Jackson
6,699,128 B1	3/2004	Beadell et al.	8,109,583 B2	2/2012	Bruestle
6,702,409 B2	3/2004	Hedrick et al.	8,210,949 B2	7/2012	Graf
D489,417 S	5/2004	Muñoz et al.	8,241,124 B2	8/2012	Kelly et al.
6,776,504 B2	8/2004	Sloan et al.	8,272,957 B2	9/2012	Crowder et al.
D495,754 S	9/2004	Wurz et al.	D673,619 S	1/2013	Seelig
D495,755 S	9/2004	Wurz et al.	D673,620 S	1/2013	Johnson et al.
D496,407 S	9/2004	Gadda et al.	D673,621 S	1/2013	Johnson et al.
D498,267 S	11/2004	Crouch	8,366,555 B2	2/2013	McGahn et al.
6,834,979 B1	12/2004	Cleaver et al.	D681,009 S	4/2013	Meng et al.
6,860,814 B2	3/2005	Cole	8,430,756 B2	4/2013	McComb et al.
6,897,624 B2	5/2005	Lys et al.	D685,435 S	7/2013	Hohman et al.
6,899,626 B1	5/2005	Luciano et al.	8,550,913 B2	10/2013	Kelly et al.
6,906,860 B2	6/2005	Starkweather	D697,558 S *	1/2014	Myers ..... D21/325
D508,268 S	8/2005	Hanchar et al.	8,651,963 B1	2/2014	Thompson
D508,961 S	8/2005	Gatto et al.	D711,062 S	8/2014	Chen
6,948,829 B2	9/2005	Verdes et al.	8,814,707 B2	8/2014	Slattery
6,962,528 B2	11/2005	Yokota	8,827,819 B2	9/2014	Thompson
D513,044 S	12/2005	Morrison	D714,875 S	10/2014	Wudtke et al.
6,997,810 B2	2/2006	Cole	D715,364 S	10/2014	Wudtke et al.
7,014,563 B2	3/2006	Stephan et al.	8,851,989 B2	10/2014	Rosander et al.
D525,664 S	7/2006	Cole	D723,626 S	3/2015	Vasquez et al.
7,123,811 B1	10/2006	Chen et al.	8,974,297 B2	3/2015	Massing et al.
D535,338 S	1/2007	Linard et al.	8,982,545 B2	3/2015	Kim et al.
7,178,941 B2	2/2007	Roberge et al.	D727,431 S *	4/2015	Themann ..... D21/370
D542,876 S	5/2007	Laurienzo et al.	9,010,889 B2	4/2015	Jung et al.
7,213,941 B2	5/2007	Sloan et al.	9,033,436 B2	5/2015	Holzappel et al.
D545,926 S	7/2007	Laurienzo et al.	D732,520 S *	6/2015	Themann ..... D14/307
7,237,925 B2	7/2007	Mayer et al.	D733,088 S	6/2015	Garneau et al.
7,284,876 B2	10/2007	Ericson	9,064,372 B2	6/2015	Rasmussen et al.
D557,348 S	12/2007	Gutknecht et al.	D738,581 S	9/2015	Elliott et al.
D559,917 S	1/2008	Cole	D740,887 S *	10/2015	Randazzo ..... D21/370
D563,481 S	3/2008	Looks et al.	D745,093 S	12/2015	Weiss et al.
D564,601 S	3/2008	Strahinic et al.	D753,090 S	4/2016	Langhammer et al.
7,339,782 B1	3/2008	Landes et al.	D757,001 S	5/2016	Kim
D566,197 S	4/2008	Greenberg et al.	D762,613 S	8/2016	Garneau et al.
7,355,573 B2	4/2008	Ogawa	D763,361 S	8/2016	Rosander et al.
7,364,505 B2	4/2008	Mattice et al.	RE46,169 E	10/2016	Kelly et al.
7,367,145 B2	5/2008	Mou	9,478,097 B2	10/2016	Hennessy et al.
7,367,685 B2	5/2008	Moll	D772,775 S	11/2016	Bird et al.
7,390,257 B2	6/2008	Paulsen et al.	9,504,919 B2	11/2016	Taylor et al.
D573,200 S	7/2008	Hashimoto et al.	9,523,875 B2	12/2016	Kim
7,397,387 B2	7/2008	Suzuki et al.	9,573,050 B2	2/2017	Thompson et al.
7,423,864 B2	9/2008	Kim et al.	9,581,844 B2	2/2017	Kim et al.
7,442,125 B2	10/2008	Paulsen et al.	9,679,435 B2	6/2017	Schrementi et al.
7,476,154 B2	1/2009	Kogo et al.	9,711,001 B2	7/2017	Zedell et al.
D586,866 S	2/2009	Hsu	D798,389 S	9/2017	Weiss et al.
7,506,463 B2	3/2009	Holst	D801,437 S	10/2017	Hohman
7,506,997 B1	3/2009	Eriksson	9,784,998 B2	10/2017	Kim
7,513,830 B2	4/2009	Hajder et al.	D813,954 S	3/2018	Calhoun et al.
D591,758 S	5/2009	Lee	D818,048 S *	5/2018	Calhoun ..... D21/369
D592,670 S	5/2009	Lee	D820,915 S	6/2018	Lee et al.
D592,709 S	5/2009	McComb et al.	10,002,488 B2	6/2018	Calhoun et al.
D592,823 S	5/2009	Weger	D826,338 S	8/2018	Bussey et al.
7,541,774 B2	6/2009	Zedell et al.	D833,623 S	11/2018	Davis
D603,909 S	11/2009	Ortiz	10,151,949 B2	12/2018	Kim et al.
D604,368 S	11/2009	Lesley et al.	10,222,638 B2	3/2019	Kim et al.
D605,231 S	12/2009	Hashimoto et al.	D845,035 S	4/2019	Raad et al.
7,641,554 B2	1/2010	Paulsen et al.	D849,149 S	5/2019	Bussey et al.
D609,158 S	2/2010	Bird et al.	D849,150 S	5/2019	Gallagher et al.
7,654,899 B2	2/2010	Durham et al.	D853,682 S	7/2019	Brown
7,667,891 B2	2/2010	Cok et al.	D854,620 S *	7/2019	Yeh ..... D21/369
7,708,640 B2	5/2010	Burak et al.	D854,621 S *	7/2019	Calhoun ..... D21/369
7,722,982 B2	5/2010	Zedell et al.	D858,641 S *	9/2019	Legras ..... D21/370
D619,177 S	7/2010	Lee	D858,642 S *	9/2019	Legras ..... D21/370
D619,660 S	7/2010	Cole et al.	D867,490 S	11/2019	Noback et al.
7,803,053 B2	9/2010	Atkinson	D888,837 S	6/2020	Lee et al.

# US D939,632 S

D893,628 S *	8/2020	Thoeni .....	D21/300	2015/0269810 A1	9/2015	Wolf et al.
D899,526 S	10/2020	Lee et al.		2015/0336005 A1	11/2015	Melnick et al.
D907,707 S *	1/2021	DeMarco .....	D21/369	2016/0005267 A1	1/2016	Kawashima et al.
D913,379 S *	3/2021	Calhoun Lewis .....	D21/369	2016/0156871 A1	6/2016	Liu
2003/0064814 A1	4/2003	Stephan et al.		2016/0343204 A1	11/2016	Maher et al.
2004/0001335 A1	1/2004	Wu		2016/0353592 A1	12/2016	Li et al.
2004/0053663 A1	3/2004	Paulsen et al.		2017/0041568 A1	2/2017	Rakshit
2004/0053699 A1	3/2004	Rasmussen et al.		2017/0053482 A1	2/2017	Ho
2004/0061284 A1	4/2004	Satoh		2017/0061730 A1	3/2017	Ho et al.
2004/0192433 A1	9/2004	Johnson		2017/0178443 A1	6/2017	Calhoun et al.
2004/0224776 A1	11/2004	Nagano		2017/0178444 A1	6/2017	Lee et al.
2004/0229698 A1	11/2004	Lind et al.		2017/0250237 A1	8/2017	Cheng
2005/0049043 A1	3/2005	Crivelli et al.		2017/0315407 A1	11/2017	Ai et al.
2005/0059486 A1	3/2005	Kaminkow		2018/0082523 A1	3/2018	Palermo et al.
2005/0107167 A1	5/2005	Sasaki		2018/0150112 A1	5/2018	Aoki et al.
2005/0113174 A1	5/2005	Izawa		2018/0180952 A1	6/2018	Park et al.
2005/0130746 A1	6/2005	Stephenson et al.		2018/0252959 A1	9/2018	Cheng
2005/0215325 A1	9/2005	Nguyen et al.		2018/0351118 A1	12/2018	Nakaie
2005/0261057 A1	11/2005	Bleich et al.		2018/0356661 A1	12/2018	Lee
2006/0030412 A1	2/2006	Cole		2019/0080553 A1	3/2019	Hohman et al.
2006/0073900 A1	4/2006	Cole		2019/0096171 A1	3/2019	Patel et al.
2006/0094511 A1	5/2006	Roireau		2019/0096173 A1 *	3/2019	Brandau ..... G07F 17/3241
2006/0100013 A1	5/2006	Enzminger		2019/0266833 A1 *	8/2019	Lee ..... H04R 1/025
2006/0131810 A1	6/2006	Nicely		2021/0192889 A1 *	6/2021	Banas ..... G09G 5/10
2006/0183552 A1	8/2006	DiMichele		2021/0192901 A1 *	6/2021	Watkins ..... G07F 17/326
2006/0205498 A1	9/2006	Kogo et al.		2021/0205716 A1 *	7/2021	Shin ..... A63F 13/90
2006/0287112 A1	12/2006	Mallory et al.		2021/0209891 A1 *	7/2021	Nakamura ..... G07F 17/3244
2007/0010318 A1	1/2007	Rigsby et al.		2021/0209893 A1 *	7/2021	Rye ..... G07F 17/3241
2007/0035965 A1	2/2007	Holst				
2007/0060387 A1	3/2007	Enzminger et al.				
2007/0149291 A1	6/2007	Mitchell				
2007/0159820 A1	7/2007	Crandell et al.				
2007/0171640 A1	7/2007	Sloan et al.				
2007/0197301 A1	8/2007	Cole				
2007/0225079 A1	9/2007	Cole				
2007/0287527 A1	12/2007	Tanabe et al.				
2007/0287528 A1	12/2007	Hirato et al.				
2007/0287544 A1	12/2007	Hirato et al.				
2008/0020838 A1	1/2008	Slattery				
2008/0076553 A1	3/2008	Paulsen et al.				
2008/0113708 A1	5/2008	Beadell et al.				
2008/0113740 A1	5/2008	McGahn et al.				
2008/0113794 A1	5/2008	Cole				
2008/0113818 A1	5/2008	Beadell et al.				
2008/0119288 A1	5/2008	Rasmussen				
2008/0119289 A1	5/2008	Lind et al.				
2008/0186415 A1	8/2008	Boud et al.				
2008/0194313 A1	8/2008	Walker				
2008/0227522 A1	9/2008	Toyoda				
2008/0227554 A1	9/2008	Cole et al.				
2008/0248852 A1	10/2008	Rasmussen				
2008/0268949 A1	10/2008	Dell				
2009/0011839 A1	1/2009	Cole				
2009/0036208 A1	2/2009	Pennington et al.				
2009/0045723 A1	2/2009	Ishikawa				
2009/0179597 A1	7/2009	Salmon				
2009/0247261 A1	10/2009	Koami				
2009/0275389 A1	11/2009	Englman et al.				
2010/0016084 A1	1/2010	Bleich et al.				
2010/0120518 A1	5/2010	Borissov et al.				
2010/0137060 A1	6/2010	Cole				
2011/0092283 A1	4/2011	Levitan et al.				
2011/0118034 A1	5/2011	Jaffe et al.				
2011/0195775 A1	8/2011	Wells				
2011/0319152 A1	12/2011	Ross et al.				
2012/0044618 A1	2/2012	Lee				
2012/0178523 A1	7/2012	Greenberg et al.				
2012/0319935 A1	12/2012	Washio				
2013/0023346 A1	1/2013	Greenberg et al.				
2013/0084948 A1	4/2013	Watkins et al.				
2013/0143647 A1	6/2013	Fujisawa et al.				
2014/0132891 A1	5/2014	Tohyama et al.				
2014/0206432 A1	7/2014	Radek et al.				
2014/0250409 A1	9/2014	Shah et al.				
2014/0256409 A1	9/2014	Wood et al.				
2014/0268876 A1	9/2014	Lee et al.				
2014/0323212 A1	10/2014	Thompson et al.				
2015/0087401 A1	3/2015	Glenn et al.				
2015/0141113 A1	5/2015	Melnick et al.				

## FOREIGN PATENT DOCUMENTS

CN	1449298 A	10/2003
CN	302535459 S	8/2013
CN	302781022	4/2014
CN	303133978	3/2015
CN	105308656 A	2/2016
CN	303617588	3/2016
CN	303932486	11/2016
CN	304030396	2/2017
CN	304030398	2/2017
CN	304081281	3/2017
CN	304104111	4/2017
CN	304201004	7/2017
CN	304284046	9/2017
CN	304284113	9/2017
CN	304287919	9/2017
DE	102014016643 A1	5/2016
JP	3443415 B2	9/2003
JP	2006034725 A	2/2006
JP	4264361 B2	5/2009
JP	4792318 B2	10/2011
JP	2013078625 A	5/2013
JP	5294616 B2	9/2013
JP	5317478 B2	10/2013
JP	D1502928	7/2014
JP	D1529194	7/2015
JP	6018136 B2	11/2016
JP	2017006582 A	1/2017
KR	3007108440000	10/2013
KR	20150105999 A	9/2015
KR	101677267 B1	11/2016
KR	3007559130000	8/2017
TW	D169011	7/2015
TW	D177195	7/2016

## OTHER PUBLICATIONS

Chen, Brian X.; Samsung's New Big-Screen Phones Differ in the Little Things; Aug. 18, 2015; The New York Times; First downloaded on Jan. 4, 2019; <https://www.nytimes.com/2015/08/20/technology/personaltech/samsungs-new-big-screen-phones-differ-in-the-little-things.html>.

Consumer Reports, New OLED TVs Deliver The Best Picture Quality Yet, Oct. 2013, p. 38. [consumerreports.org](http://consumerreports.org).

Engadget; Hands-on with LG's 5-inch flexible plastic OLED display at SID (video); first downloaded article Jan. 4, 2019; <https://www.engadget.com/2013/05/21/lg-5-inch-oled-display-hands-on/>.

Farago, Jason; Hanging Out on Pierre Paulin's Recliner, Aug. 4, 2016, First downloaded on Jan. 4, 2019 at The New York Times online at: <https://www.nytimes.com/2016/08/05/arts/design/hanging-out-on-pierre-paulins-recliner.html>.

Koden, Mitsuhiro; OLED Displays and Lighting; pp. 181-186; Published 2017; John Wiley & Sons, Ltd; West Sussex, United Kingdom.

Novomatic AG, Austria—illumiWall, illumiSign, illumiBlade, illumi-Infill, Illumi-EOB, illumiPlayer, Novomatic AG website: [https://www.novomatic.com/sites/default/files/2018-11/illumniSigns\\_G2E18\\_oct18\\_low%2015.pdf](https://www.novomatic.com/sites/default/files/2018-11/illumniSigns_G2E18_oct18_low%2015.pdf) dated Jul. 31, 2019.

Patel, Darshan, LG Plans to Showcase it's Big and Rollable OLED Panel at CES 2016; Jan. 6, 2016; Nimblechapps Blog; First downloaded on Jan. 4, 2019. <https://www.nimblechapps.com/>.

Photos Taken Jun. 16, 2019 SantaFe Casino "Belly Curve", Front and Side Views.

Strohmeier, Robert; Your PC In 2008 And Beyond, Nov. 2007, PCWorld Magazine; pp. 99-101; [www.pcworld.com](http://www.pcworld.com).

Ainsworth Gaming Cabinets screenshot taken on or before Aug. 1, 2018; <https://www.agtslots.com.au/archives/portfolio/cabinets>.

Aristocrat 55 On Helix Mounting 2.

Aristocrat 55 On Helix Mounting 4.

Aristocrat Gaming Cabinets screenshots taken on or before Aug. 1, 2018; <https://www.aristocrat.com/innovation/cabinets/>.

Aruze Gaming Machine screenshot taken on or about Aug. 1, 2018; <https://aruzegaming.com/>.

Aruze Muso Curve 43 Display taken on or about Mar. 7, 2019; <https://aruzegaming.com/muso-curve/>.

Australian Reg No. 201711650 displayed images.

Australian Reg. No. 201711655 display images.

Australian Reg. No. 201711658 display images.

Australian Reg. No. 201713995 display images.

Australian Reg. No. 201713998 display images.

Bluebird Slant Widescreen literature from [www.wms.com/technologyandinnovation\\_cabinets\\_widescreen.php](http://www.wms.com/technologyandinnovation_cabinets_widescreen.php) dated May 19, 2009, showing a giuning machine cabinet that was sold and/or publicly disclosed at least as early as Dec. 13, 2008.

DE40108464.7 Serial No. of registration 40108464-0001, Publication Date Jul. 25, 2002. 1/1-DESIGNS—Questel.

DE40202624.1, Serial No. of registration 40202624-0001, date of registration May 21, 2002; 1/1-DESIGNS—Questel.

DE49812561.0; Serial No. of registration 49812561-0001-0004; Date of Registration Jul. 14, 1999; Publication date Sep. 25, 1999; 1/1 DESIGNS—Questel.

Flame 55 Image—[www.aristocrat-us.com-2019.01.23-02-57-21](http://www.aristocrat-us.com-2019.01.23-02-57-21).

Gaming Cabinet Design Patent Drawings Figures 1-31 produced on or before Dec. 1, 2018.

Gaming Cabinet Design Patent Figures 1-12 produced on or before Dec. 1, 2018.

Grand Vision Cabinets taken on or about Mar. 7, 2019; <https://grandvisiongaming.com/cabinets/>.

High Rise 55in Bluberi Side View produced on or before Feb. 13, 2018.

Icon by AGS screenshot produced Sep. 12, 2017; <http://www.playags.com/portfolio/icon/>.

IGT Gaming Cabinet Axxis 23/23 screenshot taken on or before Aug. 1, 2018; <https://www.igt.com/products-and-services/gaming/cabinets/axxis-2323>.

Image of AGS Gaming Machine screenshot taken on or before Aug. 1, 2018.

Incredible Technologies Infinity V55 cabinet screenshot taken on or before Aug. 1, 2018; <https://gaming.itsgames.com/hardware/infinity-V55>.

International Search Report and Written Opinion for PCT/US16/66904 dated Apr. 25, 2017, 13 pages.

IT 55 Topper 001 taken on or before Feb. 13, 2018.

IT 55 Topper 002 taken on or before Feb. 13, 2018.

Japan D1144223; Application No. D2001-10858; Date of Registration Apr. 19, 2002; Publication Date Jun. 17, 2002.

Japan Serial No. D1135500; Application No. 11-37345; Date of Registration Jan. 18, 2002; Publication Date Mar. 11, 2002.

Japan Serial No. D1137636; Application No. D2001-24014; Date of Registration Feb. 8, 2002; Publication Date Apr. 2, 2002.

Japan Serial No. D1525593; Application No. D2014-18077; Date of Registration May 1, 2015; Publication Date Jun. 8, 2015.

Japan Serial No. D1536549; Application No. D2014-26882; Date of Registration Oct. 2, 2015; Publication Date Nov. 2, 2015.

Japan Serial No. D1589479; Application No. D2017-5848; Date of Registration Oct. 6, 2017; Publication Date Oct. 30, 2017.

Japan Serial No. D1589480; Application No. D2017-5849; Date of Registration Oct. 6, 2017; Publication Date Oct. 30, 2017.

Japan Serial No. D1636665; Application No. D2015-2694; Date of Registration Oct. 2, 2015; Publication Date Nov. 2, 2015.

Japan, Serial No. D1502479; Application No. D2013-28327; Date of Registration Jun. 13, 2014; Publication date Jul. 14, 2014.

Japan, Serial No. D1512277; Application No. D2014-700; Date of Registration Oct. 24, 2014; Publication Date Nov. 25, 2014.

Konami Concerto Video Slot Machine screenshot taken on or about Aug. 1, 2018; <https://www.gaming.konami.com/Games/GamesCatalog.aspx?k1=56&k2=2&K3=0&K4=0>.

Novomatic Dominator Curve 1.40 screenshot take on or before Aug. 1, 2018; <https://www.novomatic.com/en/products/gaming/cabinets/dominatorr-curve-140>.

Novomatic Panthera Curve 1.43 screenshot taken Mar. 7, 2019; <https://www.novomatic.com/en/products/gaming/cabinets/pantheratm-curve-143>.

Orion by AGS Found online Sep. 12, 2017; <https://www.playags.com/portfolio/orion/>.

Photo of Genesis DV1 cabinet released in about 2010 and depicted in U.S. Appl. No. 12/947,695.

Photo of TigerAF display Orion Slant features, Creation Date of picture: Aug. 24, 2018.

Questel; Study of AU 201711650 and AU201711658 Industrial Designs; Submitted to AGS; Date of report: Nov. 28, 2018.

Scientific Games Monopoly Cruise for Cash screenshot taken on or about Aug. 1, 2018; <https://www.sggaming.com/games/scientific-games>.

Scientific Games TwinStar J43 Game Library screenshot taken on or before Aug. 1, 2018; <https://www.sggaming.com/games/scientific-games/Twinstar-j43-game-library>.

SciGames\_Twinstar\_photo taken on or before Aug. 1, 2018.

Spec International, Inc., GEN-311 gaming machine cabinet, publicly disclosed before Dec. 13, 2008.

Design U.S. Appl. No. 29/611,757, filed Jul. 25, 2017, Titled: Button Panel.

Design U.S. Appl. No. 29/614,799, filed Aug. 23, 2017, Titled: Gaming Machine.

Design U.S. Appl. No. 29/540,241, filed Sep. 22, 2015, titled Gaming Device Wall of Light.

Design U.S. Appl. No. 29/540,396, filed Sep. 24, 2015, titled Game Tower.

U.S. Appl. No. 15/703,645, filed Sep. 13, 2017, Titled: Gaming Machine Having Door With Extended Opening and Closing Control.

U.S. Appl. No. 15/718,250, filed Sep. 28, 2017; Titled: Mounting Configuration and Method for a Topper Display of a Gaming Machine.

U.S. Appl. No. 16/044,999, filed Jul. 25, 2018, Titled: Component Mounting Configurations for a Gaming Machine Cabinet.

U.S. Appl. No. 16/103,488, filed Aug. 14, 2018, Titled: Gaming Machine Display Mounting and Alignment Configuration and Method.

U.S. Appl. No. 12/947,695, filed Nov. 16, 2010, titled Edge Lighted Gaming Panels for Electronic Gaming Device.

\* cited by examiner

*Primary Examiner* — Khawaja Anwar  
*Assistant Examiner* — Julice Seung Eun Oum  
 (74) *Attorney, Agent, or Firm* — Wolf IP Law PLLC;  
 Dean E. Wolf, Esq.

(57)

#### CLAIM

The ornamental design for a gaming machine, as shown and described.

#### DESCRIPTION

FIG. 1 is a front isometric view of a gaming machine according to a first embodiment of the present disclosure.

FIG. 2 is a front elevation view thereof.

FIG. 3 is a rear elevation view thereof.

FIG. 4 is a first side view thereof.

FIG. 5 is a second side view thereof.

FIG. 6 is a top plan view thereof.

FIG. 7 is a bottom plan view thereof.

FIG. 8 is an isometric view of a button panel and adjacent portions of the gaming machine dashboard illustrated in FIG. 1;

FIG. 9 is top plan view of the button panel illustrated in FIG. 8.

FIG. 10 is a front isometric view of a gaming machine according to a second embodiment of the present disclosure.

FIG. 11 is a front elevation view thereof.

FIG. 12 is a rear elevation view thereof.

FIG. 13 is a first side view thereof.

FIG. 14 is a second side view thereof.

FIG. 15 is a top plan view thereof.

FIG. 16 is a bottom plan view thereof.

FIG. 17 is an isometric view of a button panel and adjacent portions of the gaming machine dashboard illustrated in FIG. 10; and,

FIG. 18 is top plan view of the button panel illustrated in FIG. 17.

The shade lines in the Figures show contour and not surface ornamentation. The broken lines in the Figures show portions of the support structure and its surrounding environment that form no part of the claimed design.

**1 Claim, 18 Drawing Sheets**

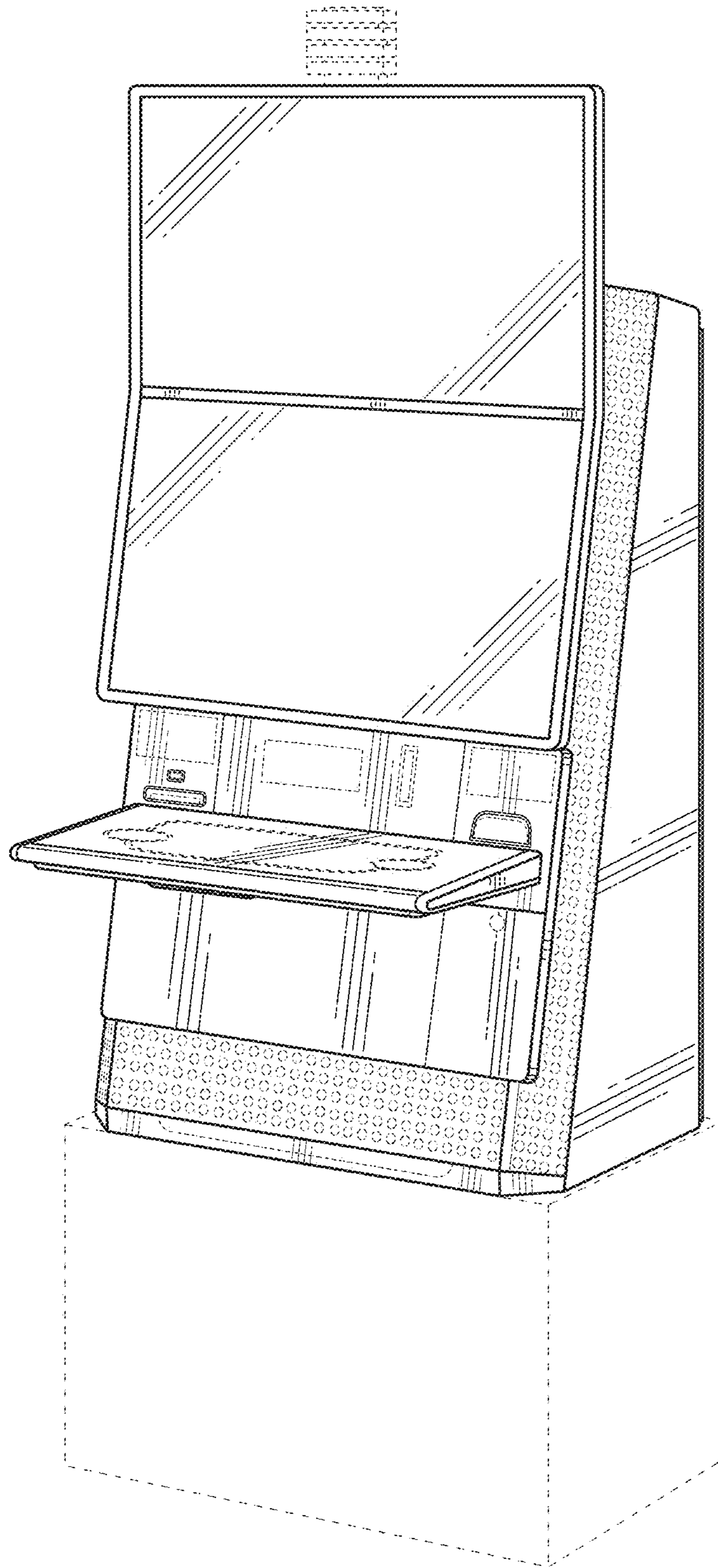

FIG. 1

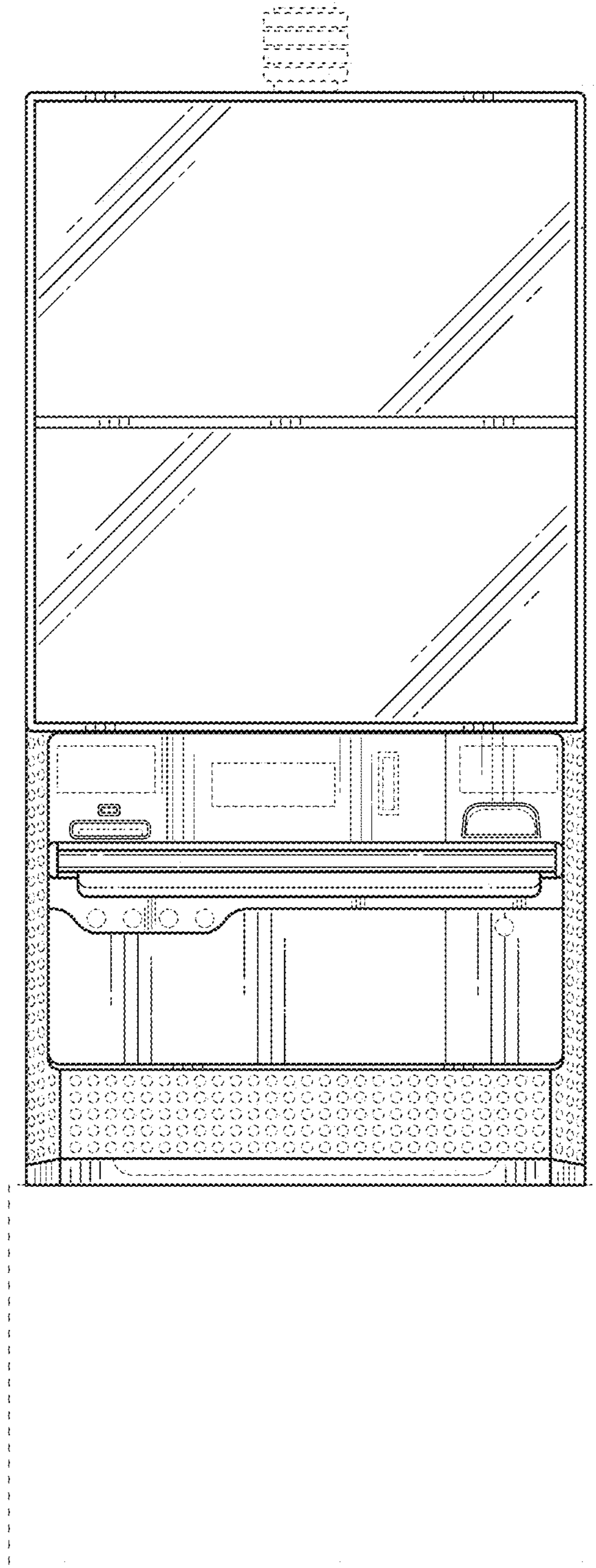

FIG. 2

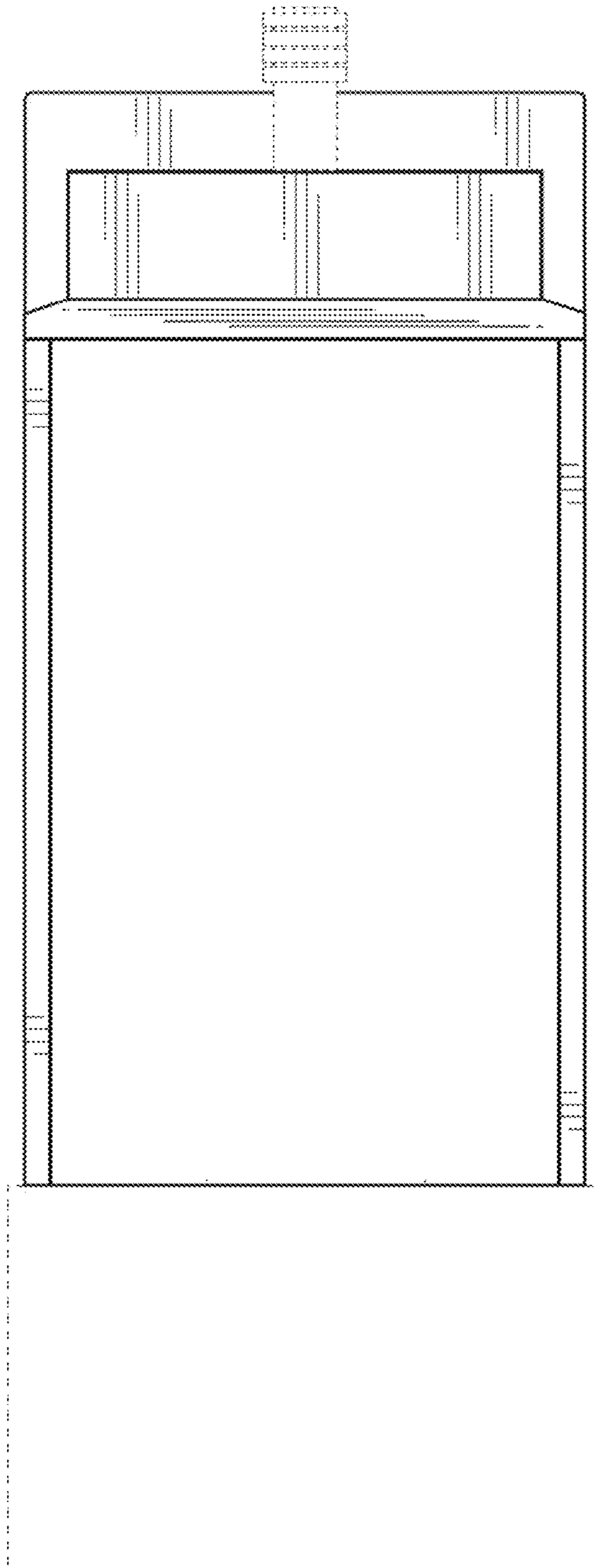

Fig. 3



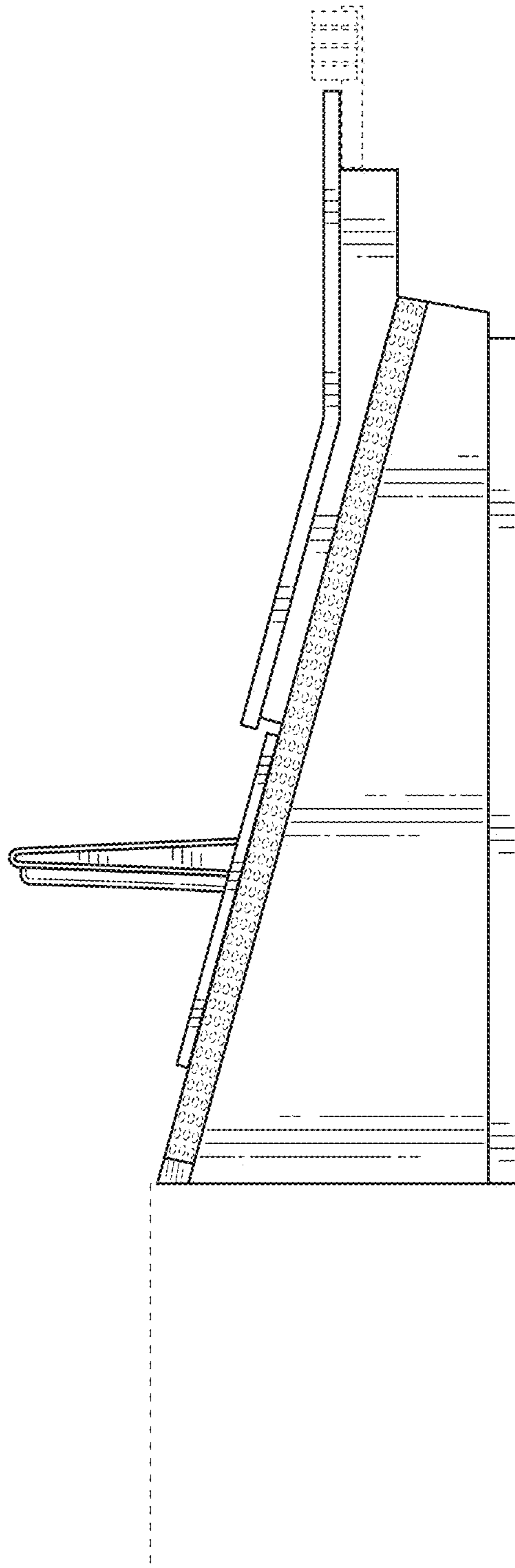

FIG. 4

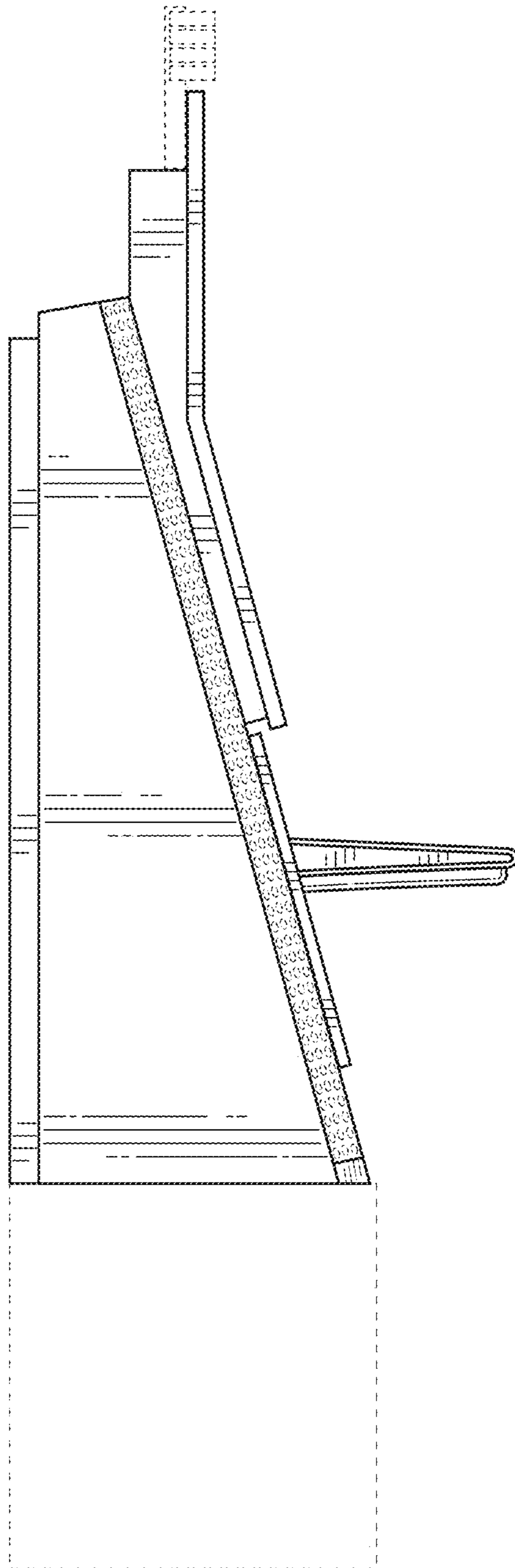

FIG. 5

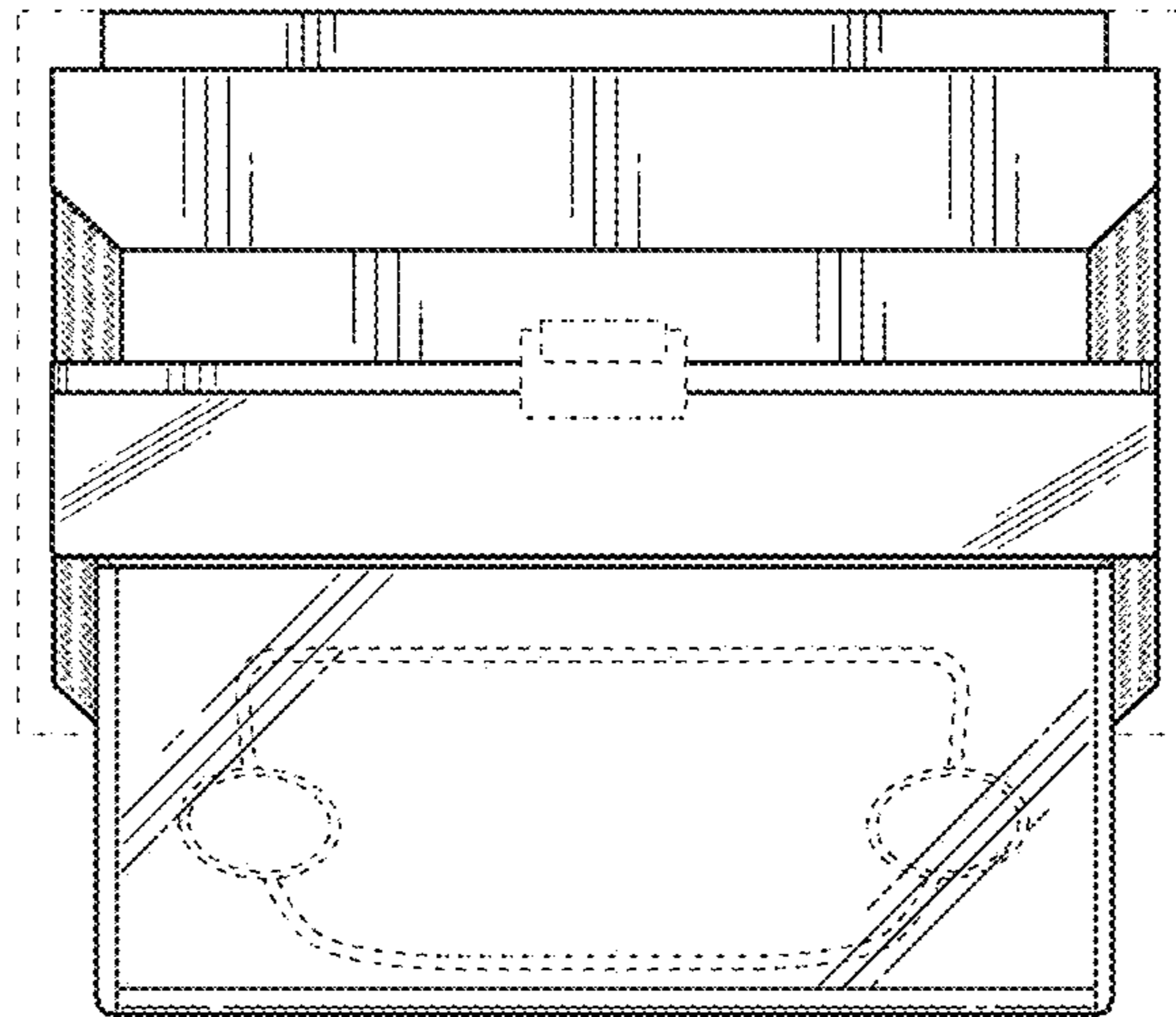

FIG. 6

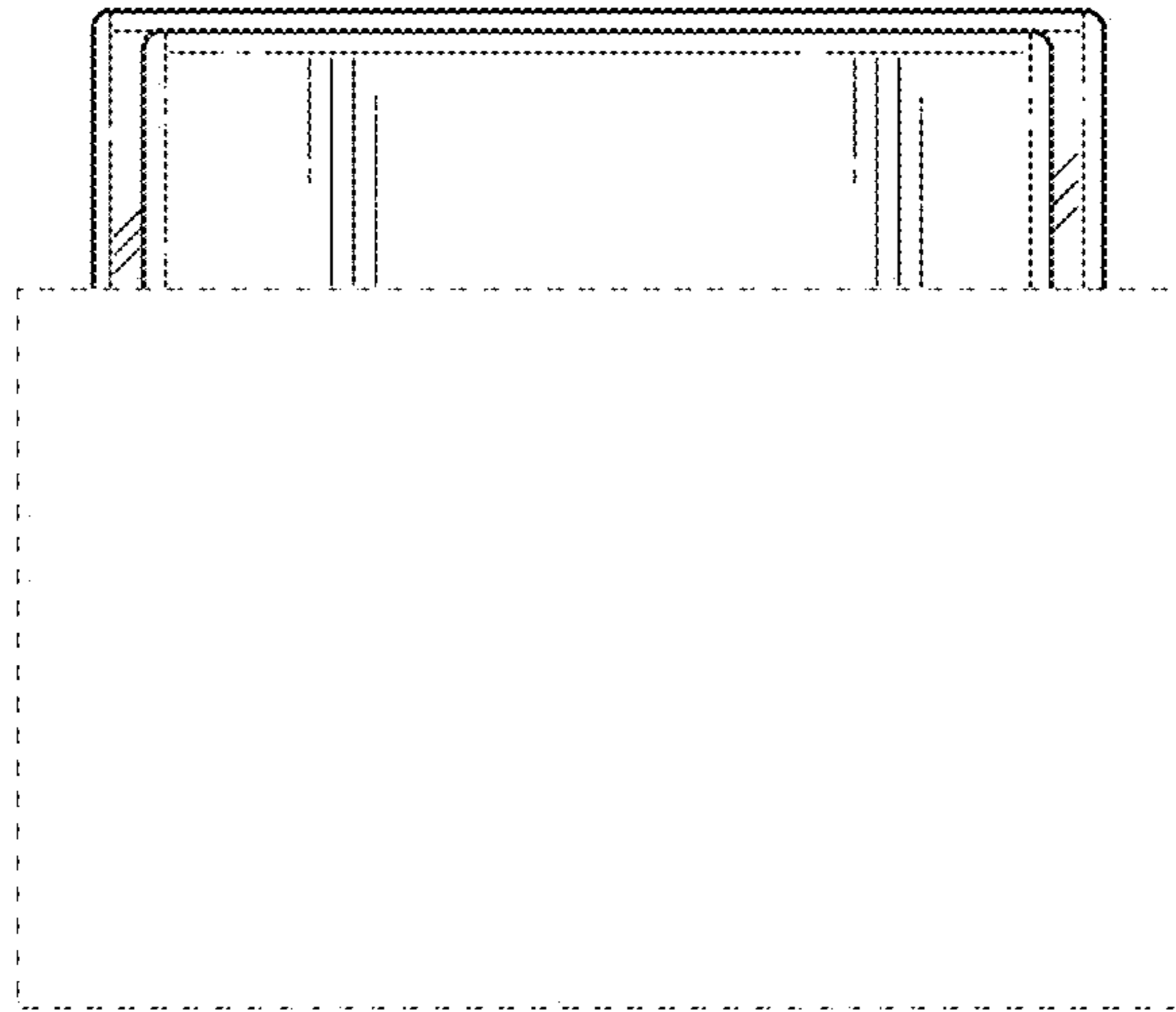

FIG. 7

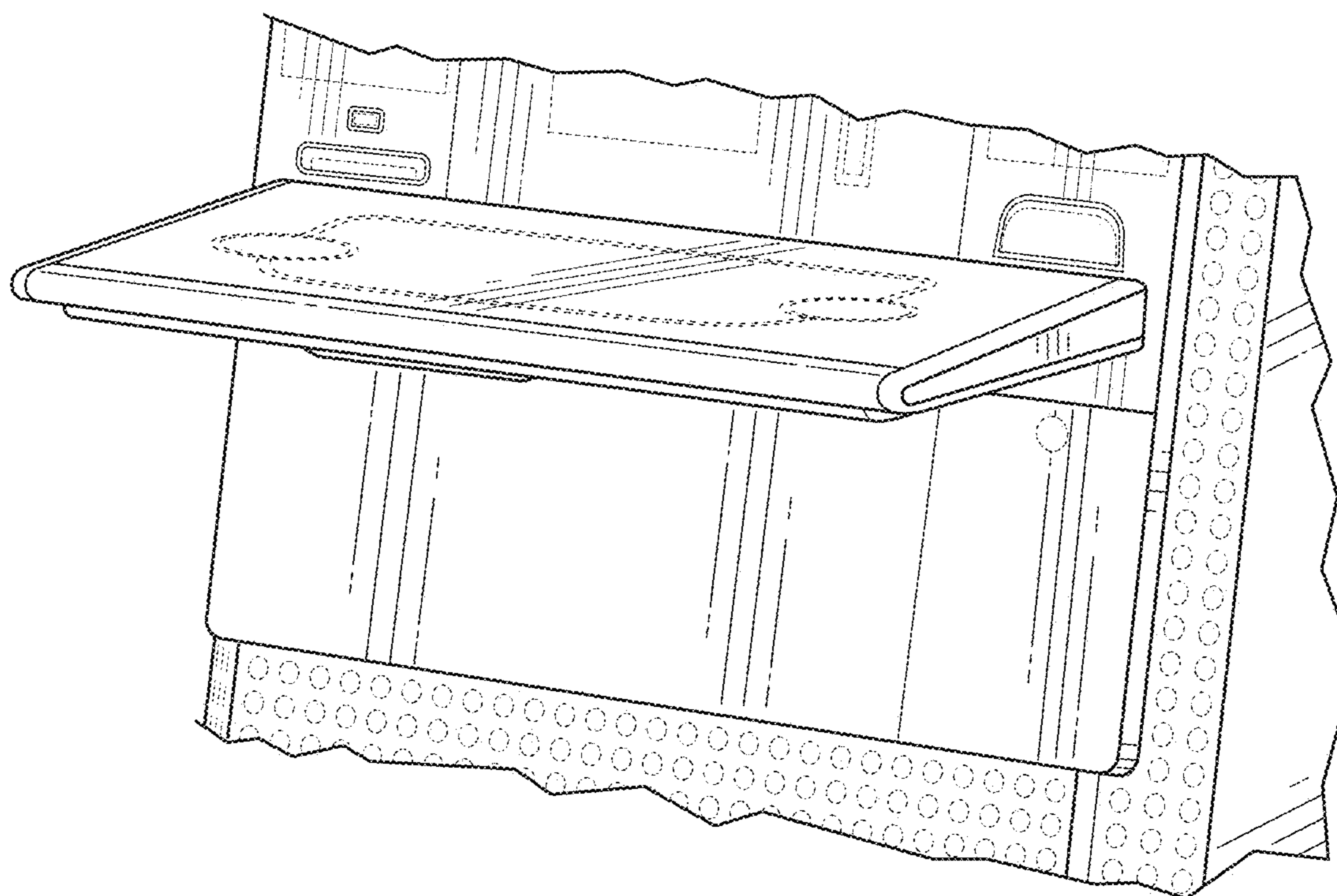

FIG. 8

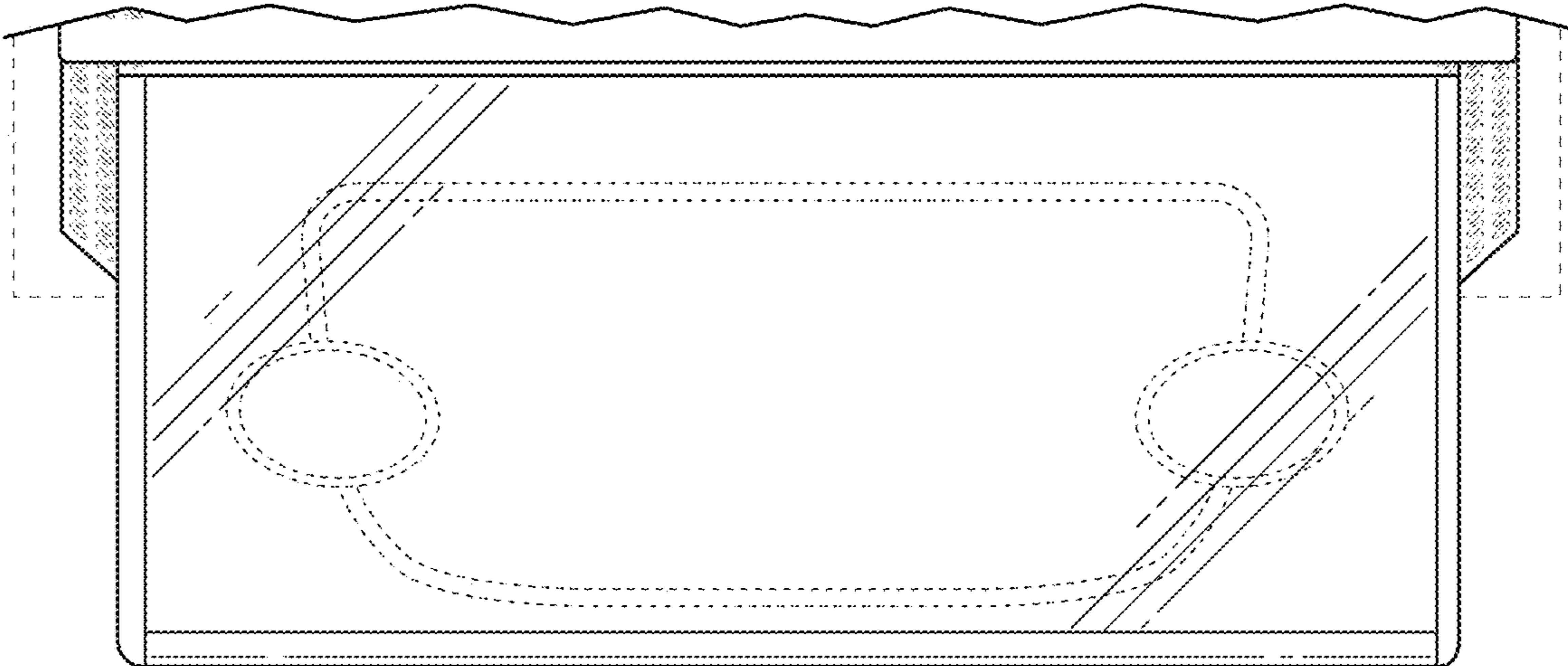

FIG. 9

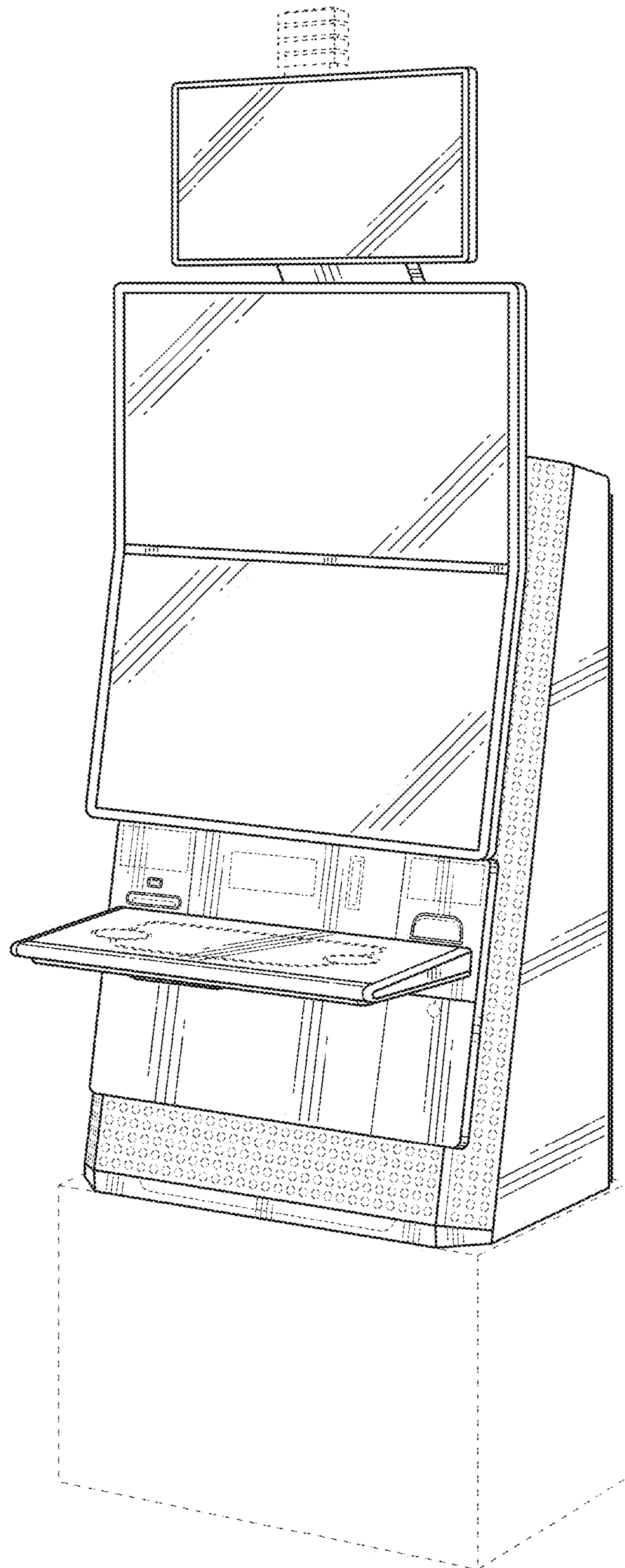

FIG. 10

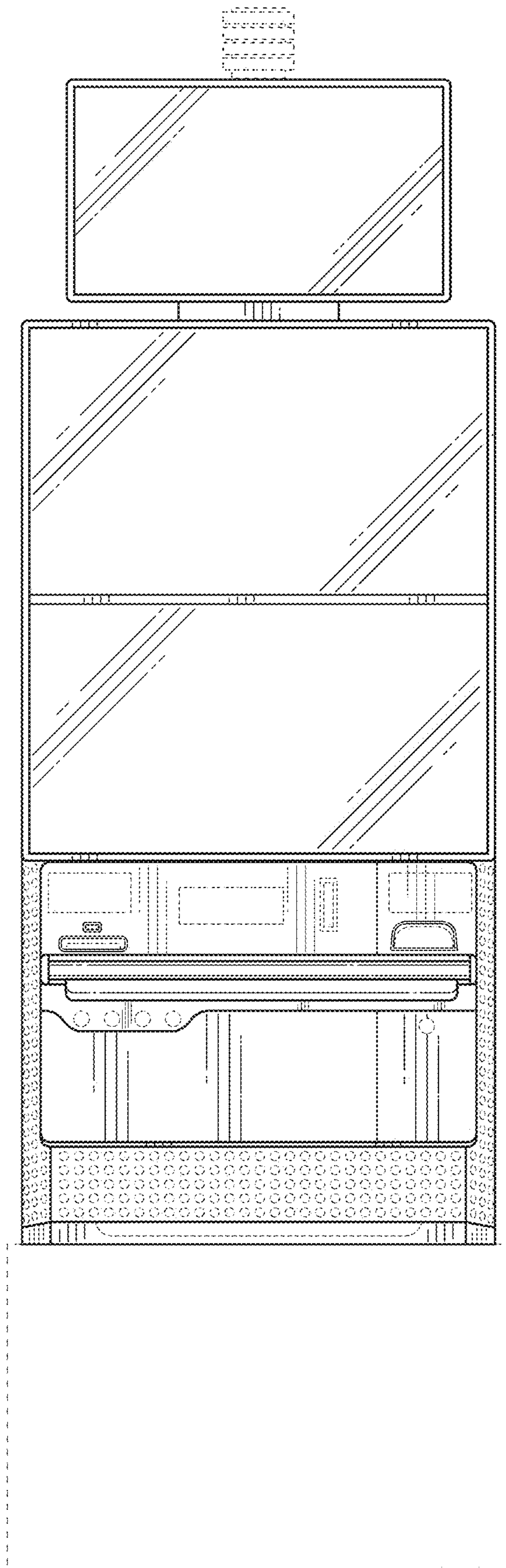

FIG. 11



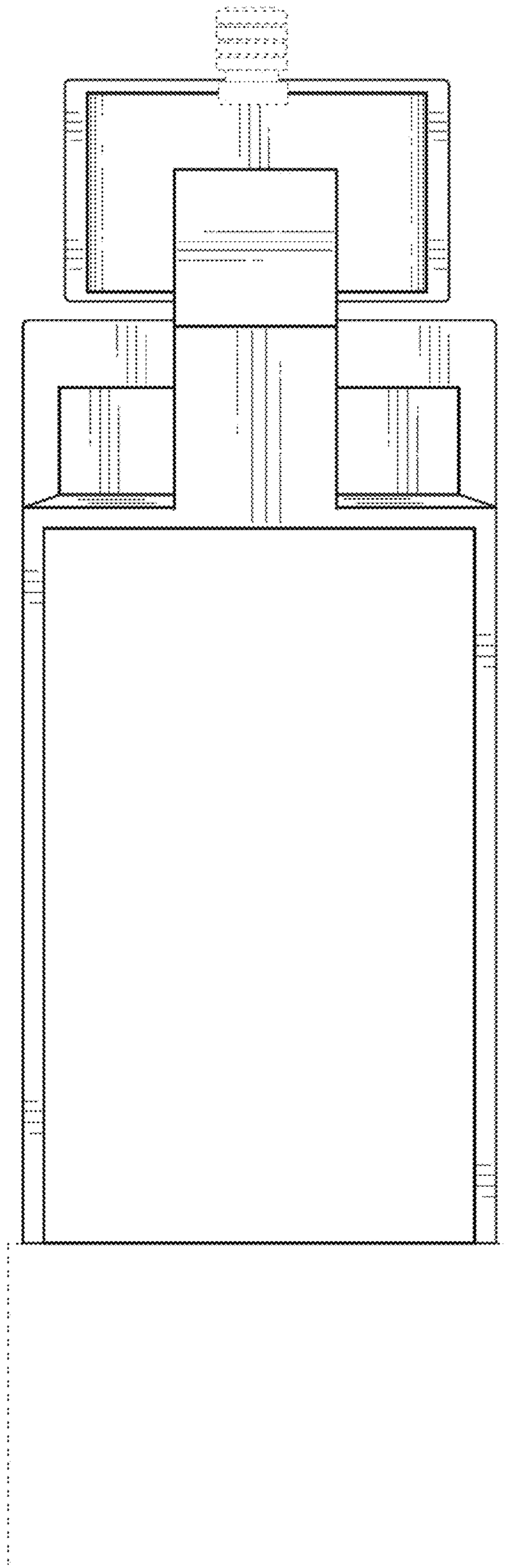

Fig. 12

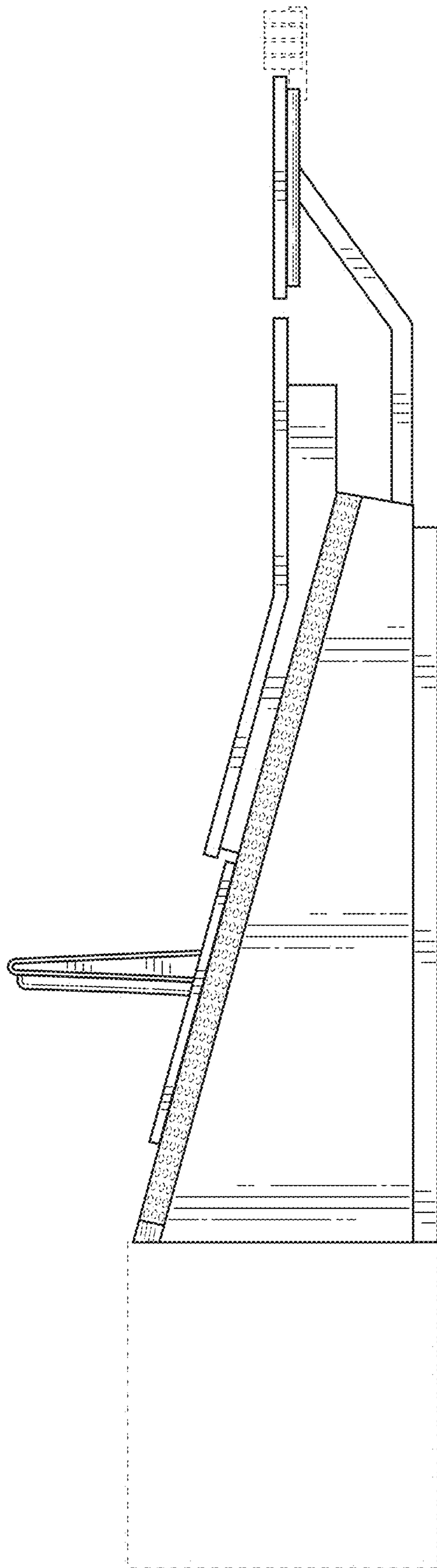

FIG. 13

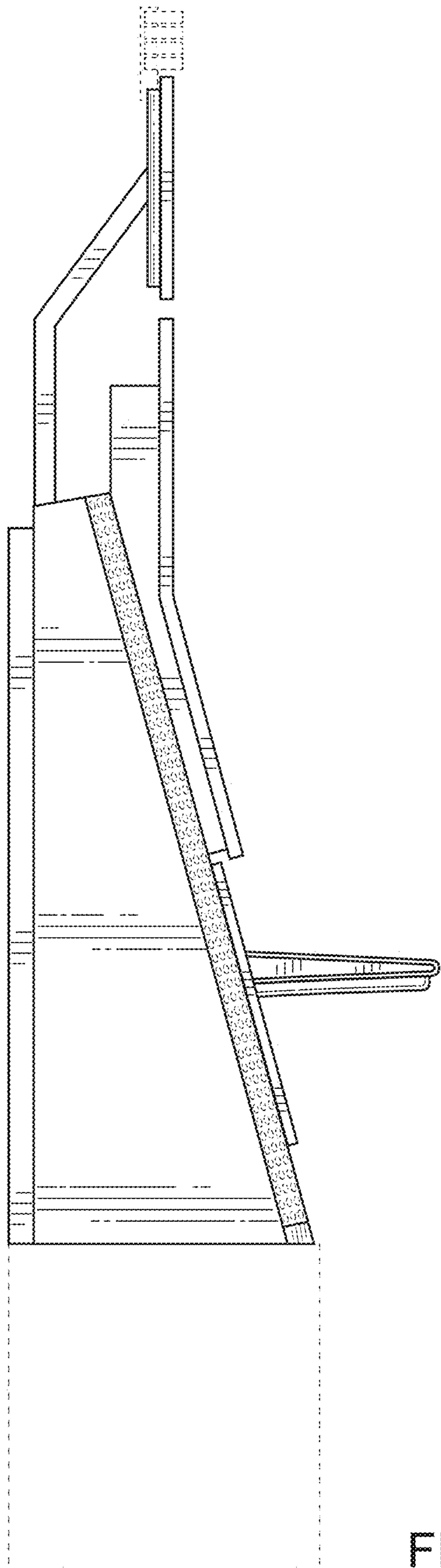

FIG. 14

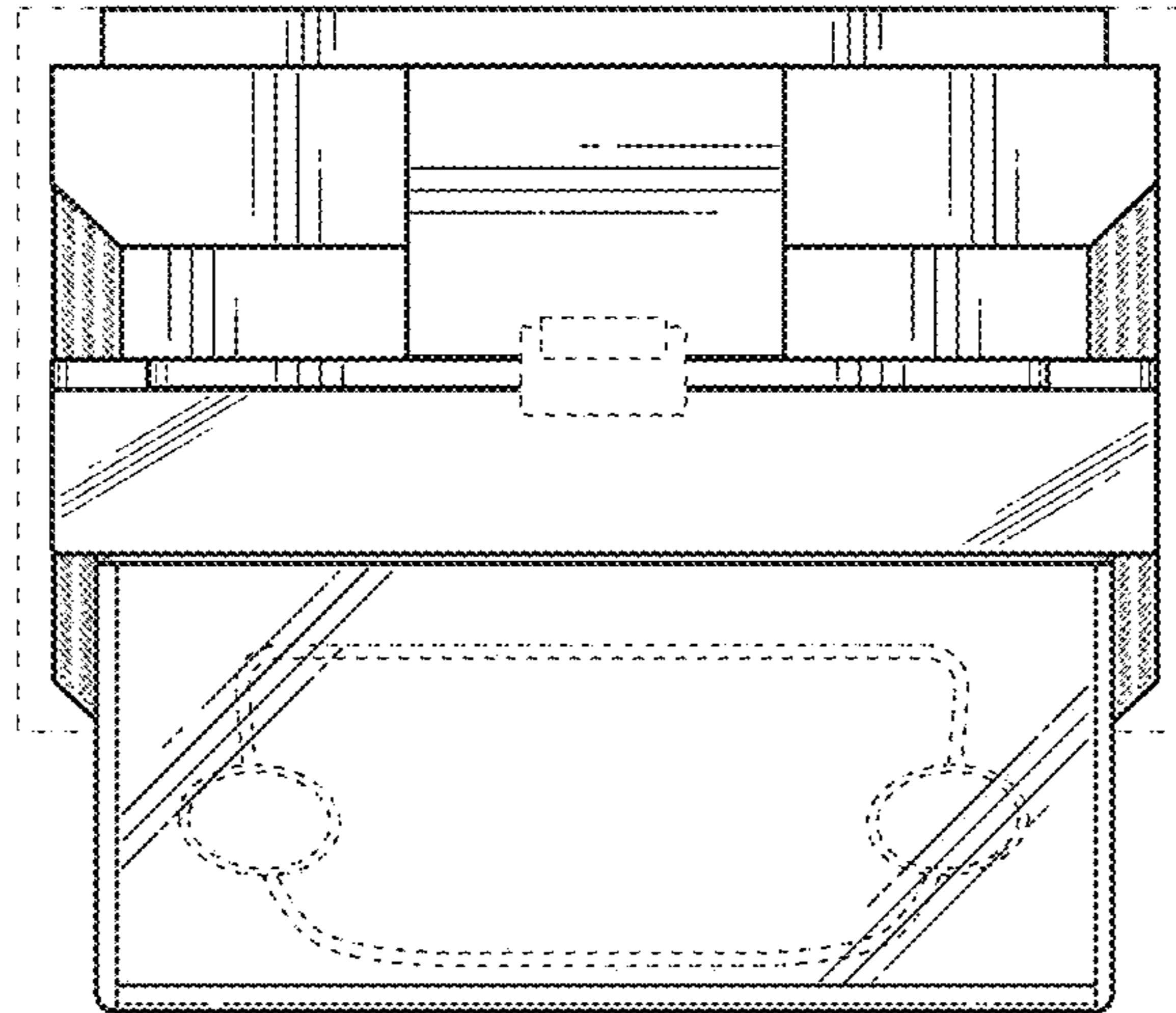

FIG. 15

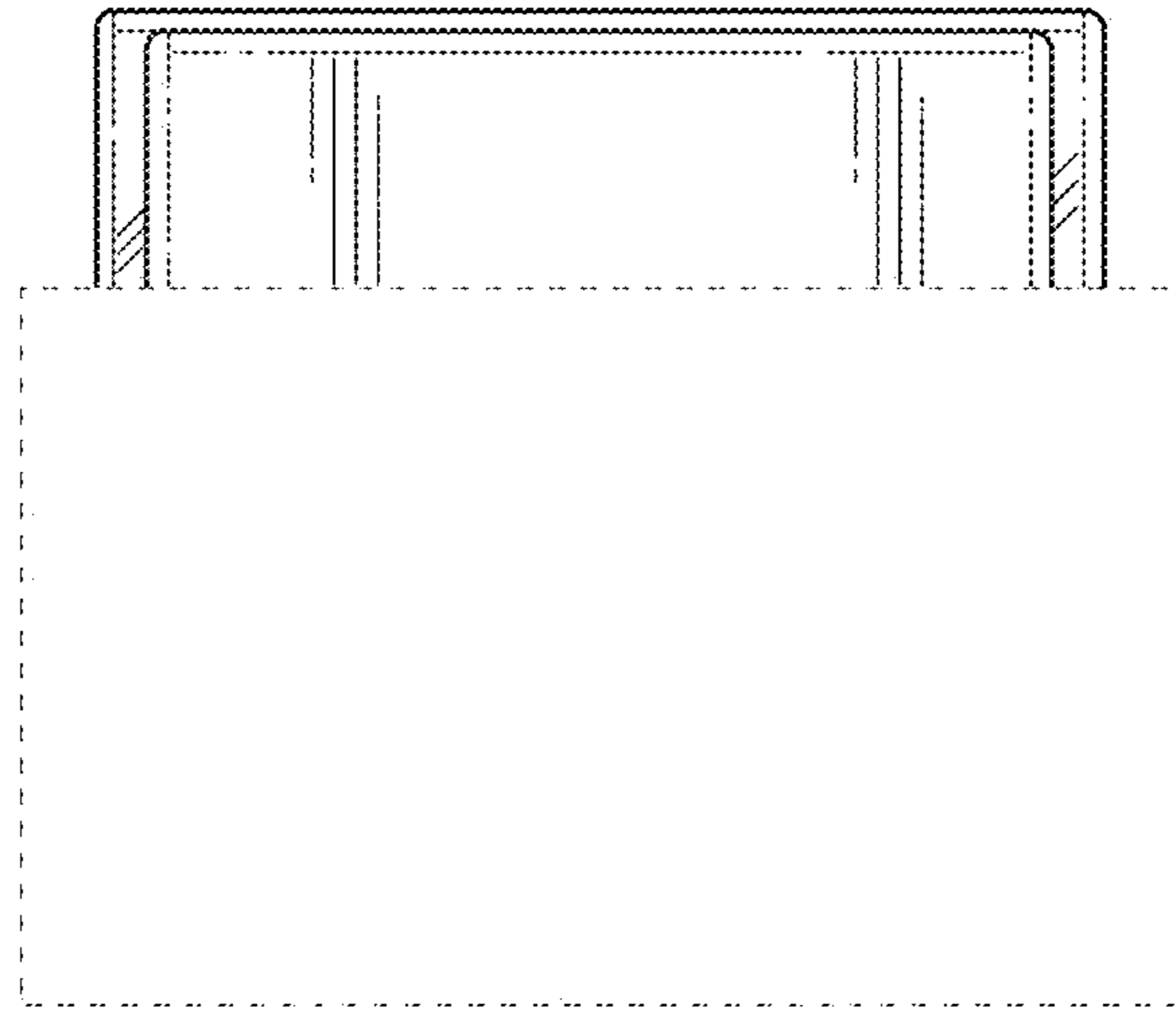

FIG. 16

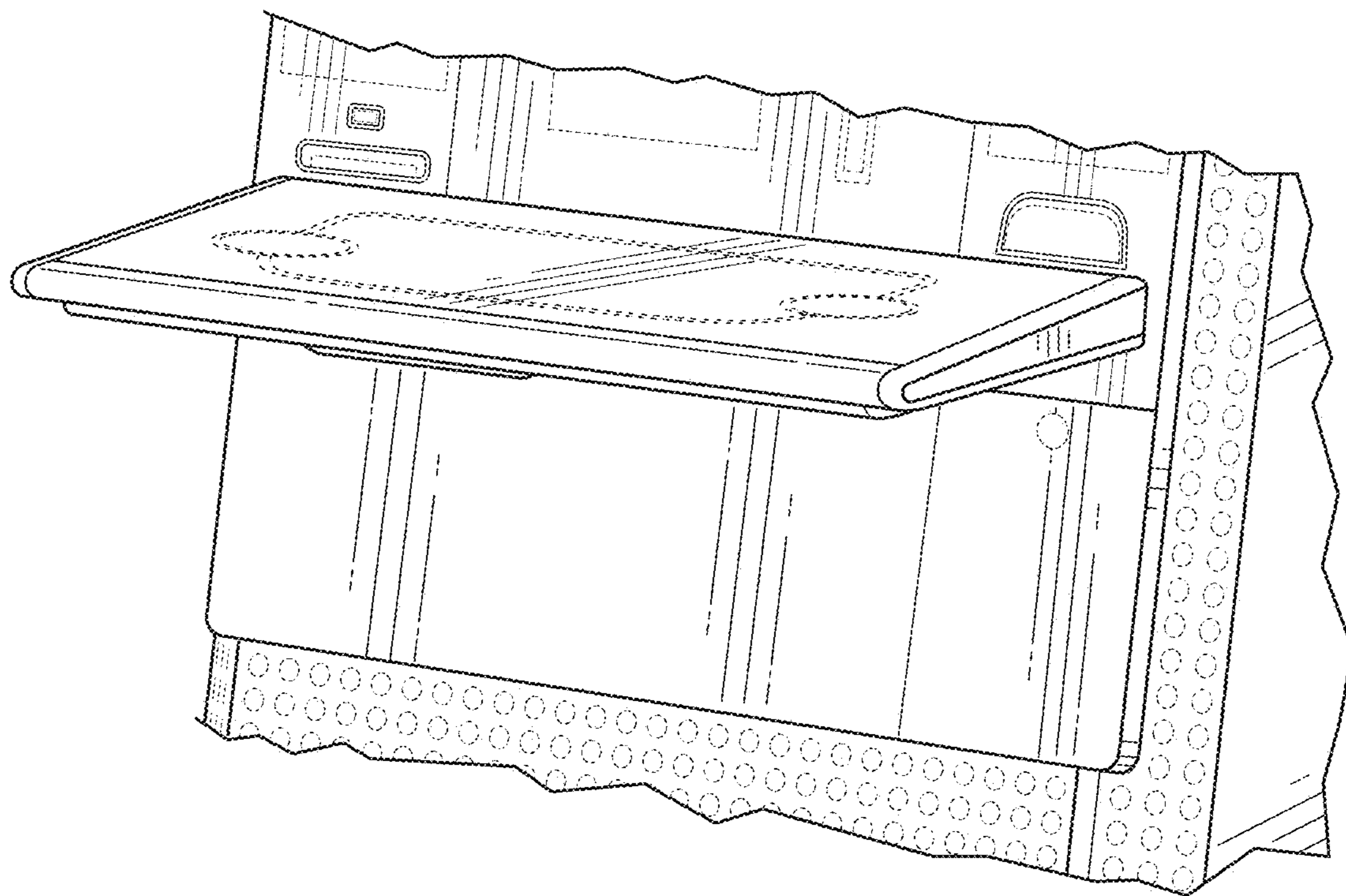

FIG. 17

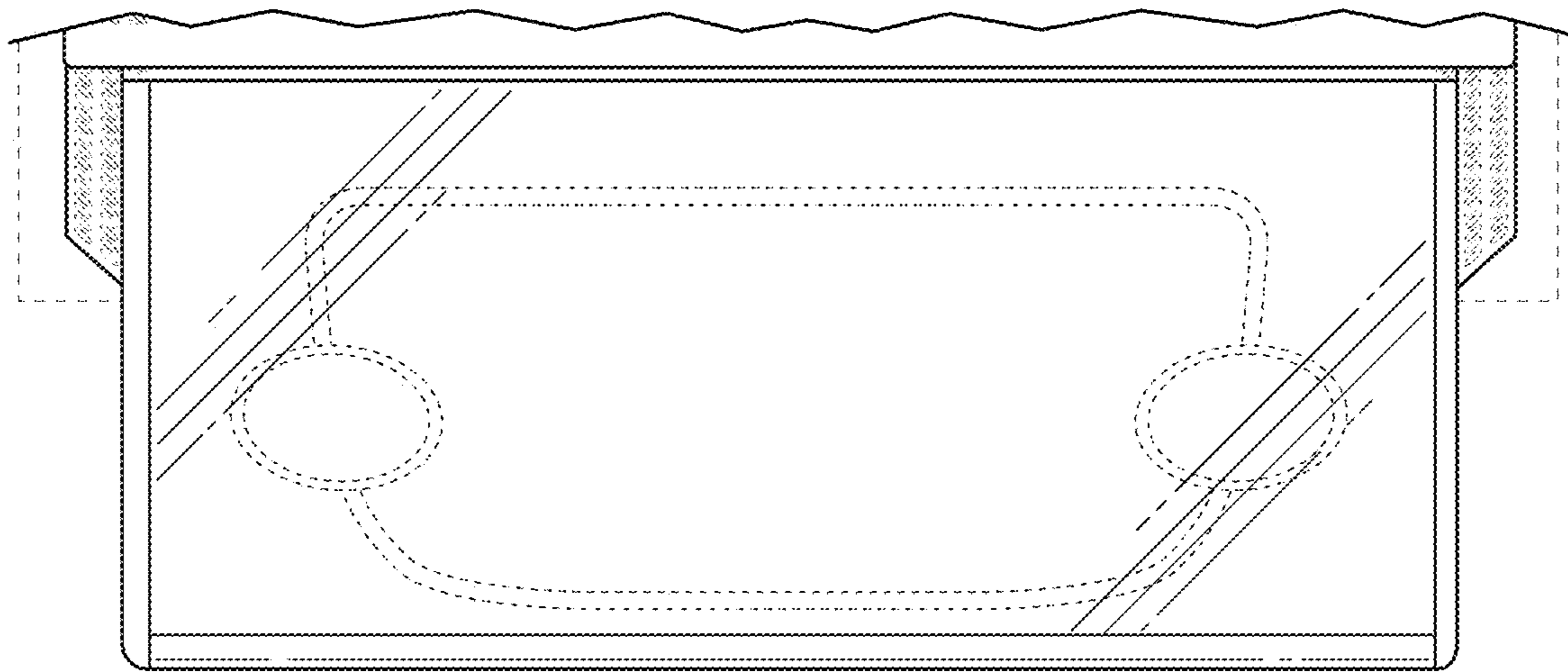

FIG. 18