



US00D939621S

(12) **United States Design Patent**
Tobias et al.

(10) **Patent No.:** **US D939,621 S**

(45) **Date of Patent:** **** Dec. 28, 2021**

(54) **SYNTHESIZER**

(71) Applicant: **Focusrite Audio Engineering Limited**,
High Wycombe (GB)

(72) Inventors: **Krischa Tobias**, London (GB); **Peter Phillips**, Milford-On-Sea (GB); **Jerome Meunier**, Oxford (GB); **Joe Munday**, London (GB)

(73) Assignee: **Focusrite Audio Engineering Limited**,
High Wycombe (GB)

(**) Term: **15 Years**

(21) Appl. No.: **29/727,863**

(22) Filed: **Mar. 13, 2020**

(30) **Foreign Application Priority Data**

Sep. 17, 2019 (EM) 006874558-0001
Sep. 17, 2019 (EM) 006874558-0002
Sep. 17, 2019 (GB) 6071196
Sep. 17, 2019 (GB) 6071197

(51) **LOC (13) Cl.** **17-01**

(52) **U.S. Cl.**
USPC **D17/2; D17/99**

(58) **Field of Classification Search**
USPC D17/1, 2, 7, 99; D21/405, 409, 411;
D14/203.1
CPC G10C 1/00; G10C 3/00; G10C 3/12
See application file for complete search history.

(56) **References Cited**

U.S. PATENT DOCUMENTS

D258,214 S * 2/1981 Kira D17/1
D305,772 S 1/1990 Kitsuyu
D313,034 S 12/1990 Koide
D369,175 S 4/1996 Nakada
D400,910 S 11/1998 Mikage
D444,460 S * 7/2001 Kitazawa D14/217

D461,837 S 8/2002 Chan
D569,415 S * 5/2008 Shigeru D17/1
D572,299 S 7/2008 Sakaguchi et al.
7,465,868 B2 * 12/2008 Lengeling G10H 1/34
84/719
D636,013 S 4/2011 Shin et al.
D719,609 S 12/2014 Takei
D776,190 S * 1/2017 Kimura D17/2
D778,342 S * 2/2017 Washio D17/1

(Continued)

FOREIGN PATENT DOCUMENTS

DE 3216271 A1 * 12/1982 G10C 3/12
EM 002943704-0001 1/2016

(Continued)

OTHER PUBLICATIONS

Substantive Report issued by the Chilean Patent Office on Jan. 20, 2021 for Application No. 2020-000667.

Primary Examiner — R. Johnson

(74) *Attorney, Agent, or Firm* — Frost Brown Todd LLC;
Dennis S. Schell

(57) **CLAIM**

The ornamental design for a synthesizer, as shown and described.

DESCRIPTION

FIG. 1 is a top perspective view of the synthesizer;
FIG. 2 is a right-side elevational view thereof;
FIG. 3 is a rear elevational view thereof;
FIG. 4 is a left-side elevational view thereof;
FIG. 5 is a top plan view thereof;
FIG. 6 is a front elevational view thereof; and,
FIG. 7 is a bottom plan view thereof.
The broken lines shown in the drawings are included for the purpose of illustrating unclaimed portions of the synthesizer and form no part of the claimed design.

1 Claim, 7 Drawing Sheets

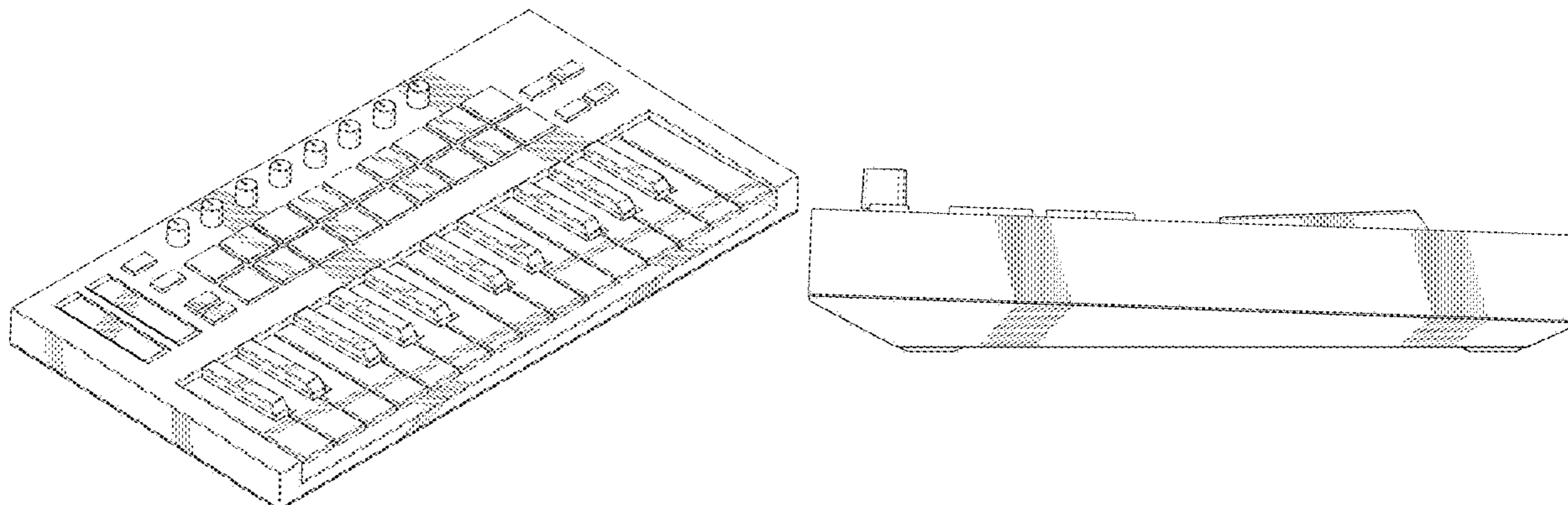

(56)

References Cited

U.S. PATENT DOCUMENTS

D778,347 S 2/2017 Gonzalez
D792,921 S 7/2017 Takei
D823,377 S * 7/2018 Kitamura D17/99
D835,181 S * 12/2018 Rosenberg D17/1
D881,268 S * 4/2020 Kuramoto D17/99
2005/0241467 A1* 11/2005 Lo G10H 1/344
84/744
2016/0063980 A1* 3/2016 Buese G10H 1/22
84/744

FOREIGN PATENT DOCUMENTS

EM 006038519-0003 1/2019
EM 006437141-0002 5/2019
EM 006437141-0001 6/2019

* cited by examiner

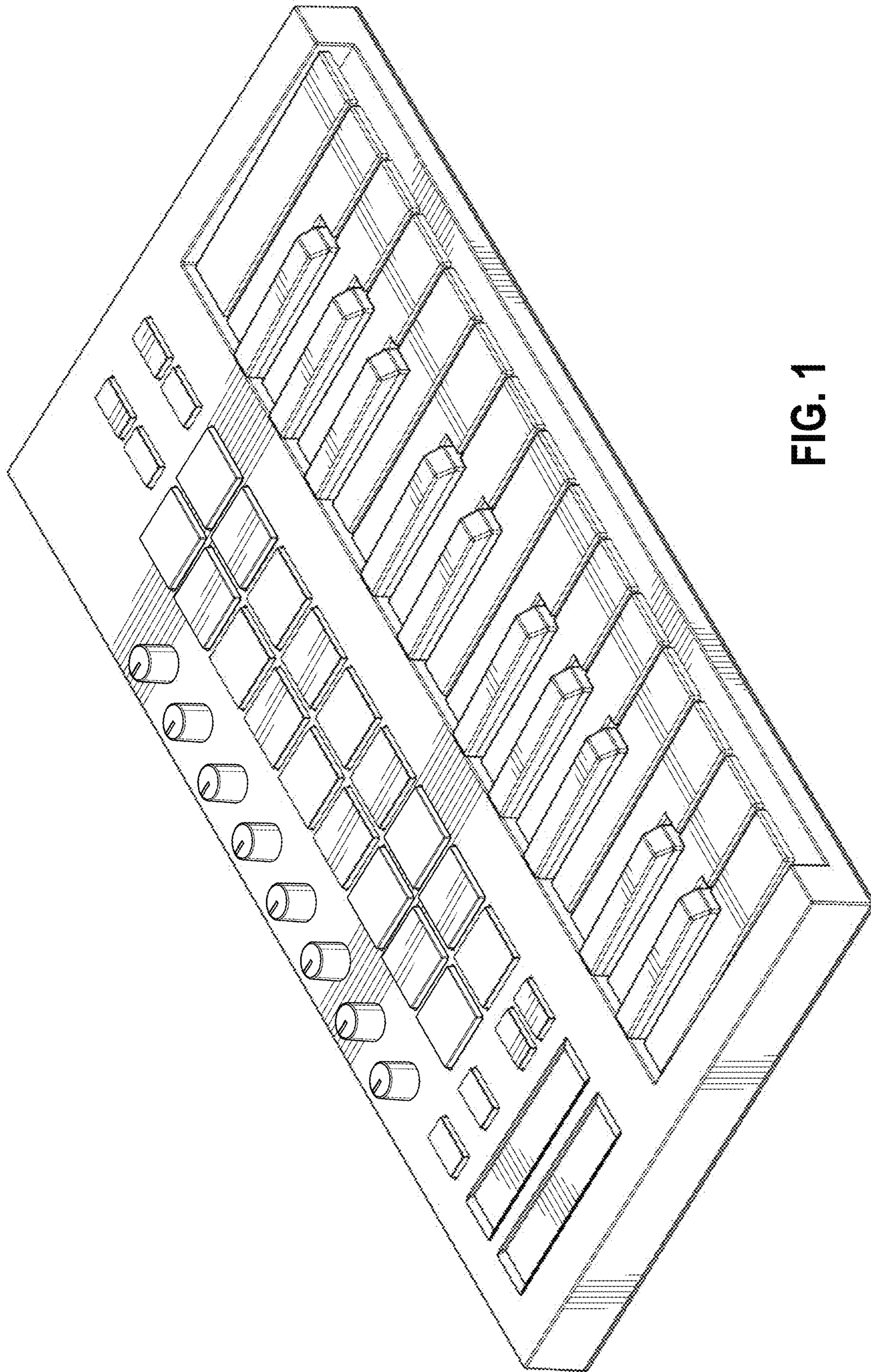

FIG. 1

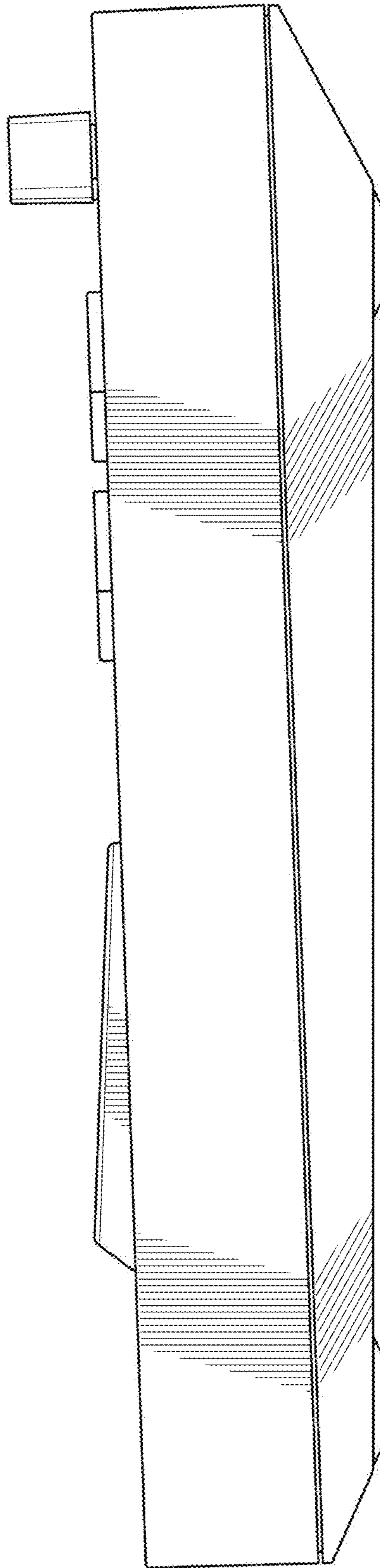

FIG. 2

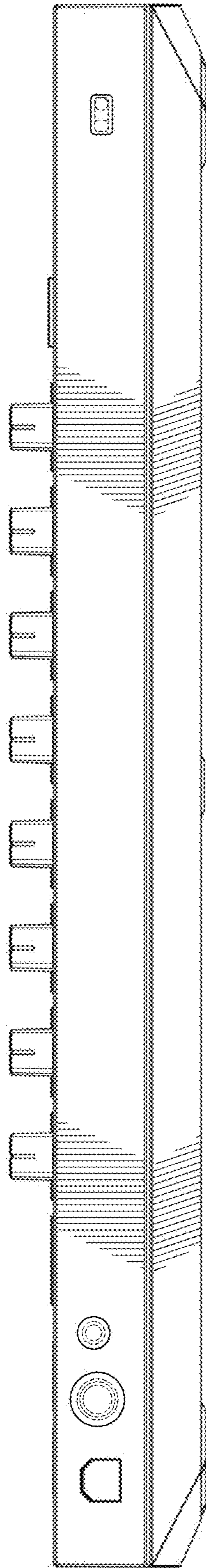

FIG. 3

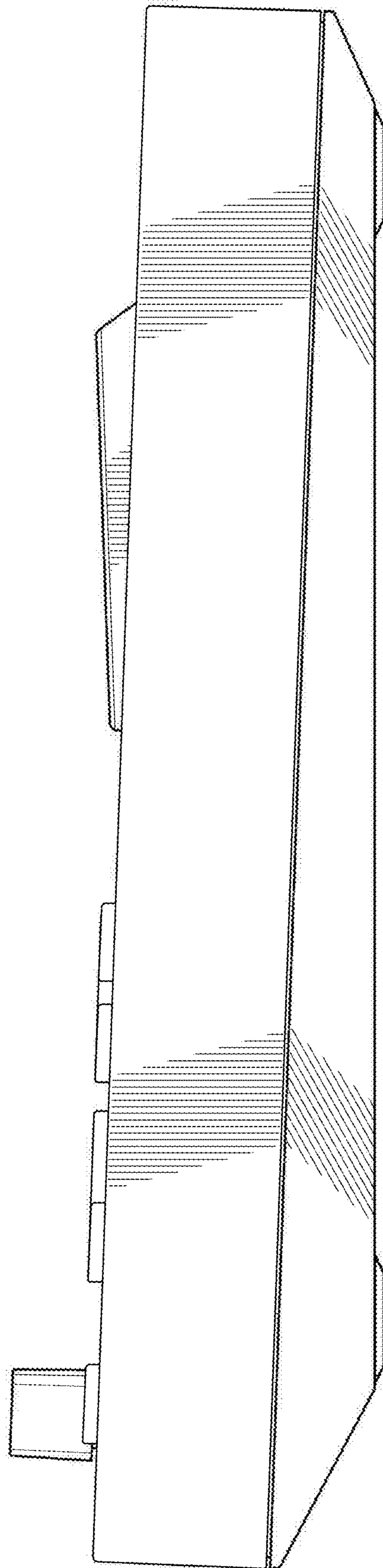

FIG. 4

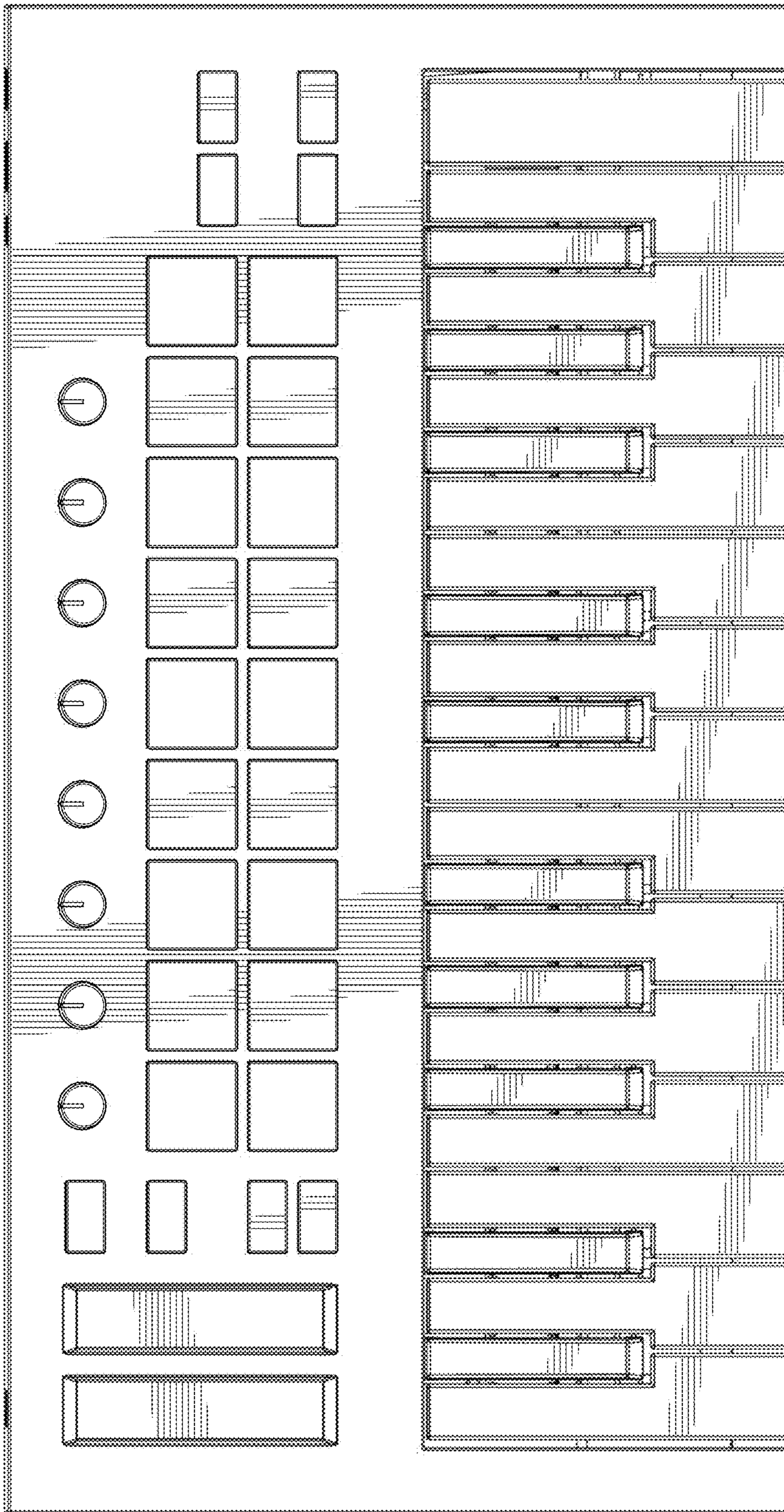

FIG. 5

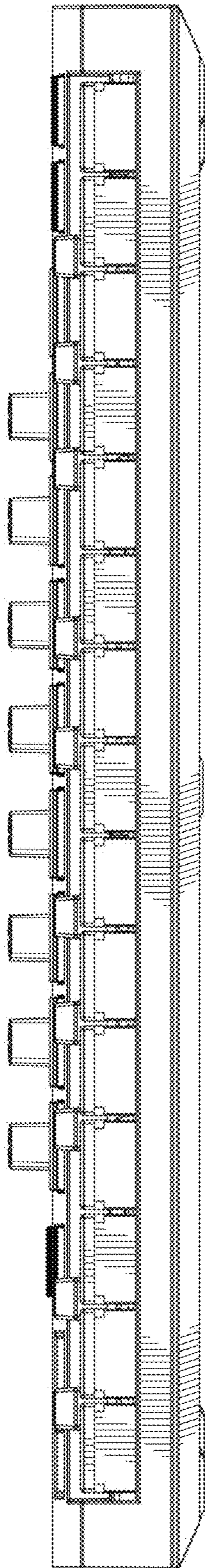

FIG. 6

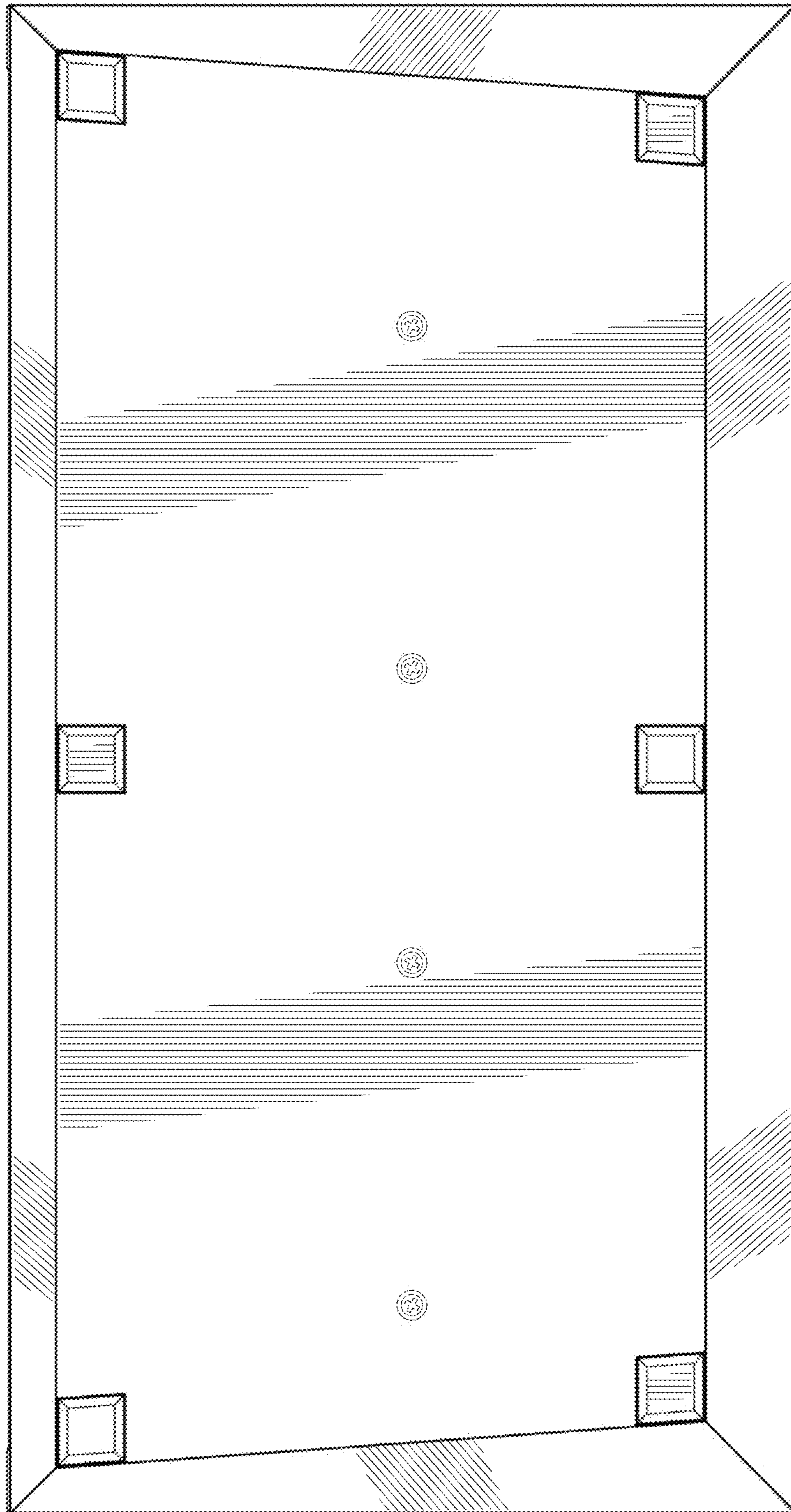

FIG. 7