



US00D939511S

(12) **United States Design Patent**
Chen et al.

(10) **Patent No.:** **US D939,511 S**

(45) **Date of Patent:** **** Dec. 28, 2021**

(54) **PROTECTING STRUCTURE AND FIXING BUCKLE FOR NOTEBOOK COMPUTER**

(71) Applicant: **Acer Incorporated**, New Taipei (TW)

(72) Inventors: **Wei-Chang Chen**, New Taipei (TW);
Jung-Wei Tsao, New Taipei (TW)

(73) Assignee: **Acer Incorporated**, New Taipei (TW)

(**) Term: **15 Years**

(21) Appl. No.: **29/708,543**

(22) Filed: **Oct. 7, 2019**

(30) **Foreign Application Priority Data**

Jun. 27, 2019 (TW) 108303825

(51) **LOC (13) Cl.** **14-02**

(52) **U.S. Cl.**
USPC **D14/439**

(58) **Field of Classification Search**
USPC D14/439, 432, 448, 315, 318, 319, 217,
D14/238.1, 240, 248, 250-53, 440, 447,
D14/496, 218, 327, 324, 328; D3/201,
D3/218, 269, 273, 318, 321, 323, 328;
D8/400, 402, 403
CPC G06F 1/181; G06F 1/1628; G06F 1/1626;
G06F 1/203; G06F 1/1633; G06F 1/166;
B65D 81/053; B65D 81/054; B65D
81/055; B65D 81/056; B65D 81/057;
B65D 81/058; B65D 71/04; H04B
1/3888; H04M 1/026; A47B 2095/046;
A47B 95/043

See application file for complete search history.

(56) **References Cited**

U.S. PATENT DOCUMENTS

D385,180 S * 10/1997 Brandes D8/403
D442,182 S * 5/2001 Oross D14/439

D623,646 S * 9/2010 Peng D14/324
D623,648 S * 9/2010 Hsu D14/324
D623,651 S * 9/2010 Hsu D14/439
D693,819 S * 11/2013 Cocquyt D14/439
D722,598 S * 2/2015 Leonard D14/315
D723,027 S * 2/2015 Leonard D14/315
D801,798 S * 11/2017 Teng D8/403
D875,100 S * 2/2020 Chang D14/440
D888,050 S * 6/2020 Tosh D14/328
D888,719 S * 6/2020 Moore D14/440

(Continued)

Primary Examiner — Ramzi Almatrahi

Assistant Examiner — Charles Cunningham

(74) *Attorney, Agent, or Firm* — JCIPRNET

(57) **CLAIM**

The ornamental design for a protecting structure and fixing buckle for notebook computer, as shown and described.

DESCRIPTION

FIG. 1 is a top, front, and right side perspective view of a protecting structure and fixing buckle for notebook computer showing our new design;
FIG. 2 is a front view thereof;
FIG. 3 is a rear view thereof;
FIG. 4 is a left side view thereof;
FIG. 5 is a right side view thereof;
FIG. 6 is a top view thereof;
FIG. 7 is a bottom view thereof;
FIG. 8 is a cross-sectional perspective view taken along line 8-8 in FIG. 2; and,
FIG. 9 is a bottom, front, and right side perspective view thereof, in which the protecting structure and fixing buckle is installed on the notebook computer.
The broken lines depict portions of the protecting structure and fixing buckle for notebook computer in which the design is embodied that form no part of the claimed design. Additionally, the dot-dash lines showing a notebook computer in FIG. 9 represent environmental structure and form no part of the claimed design.

1 Claim, 7 Drawing Sheets

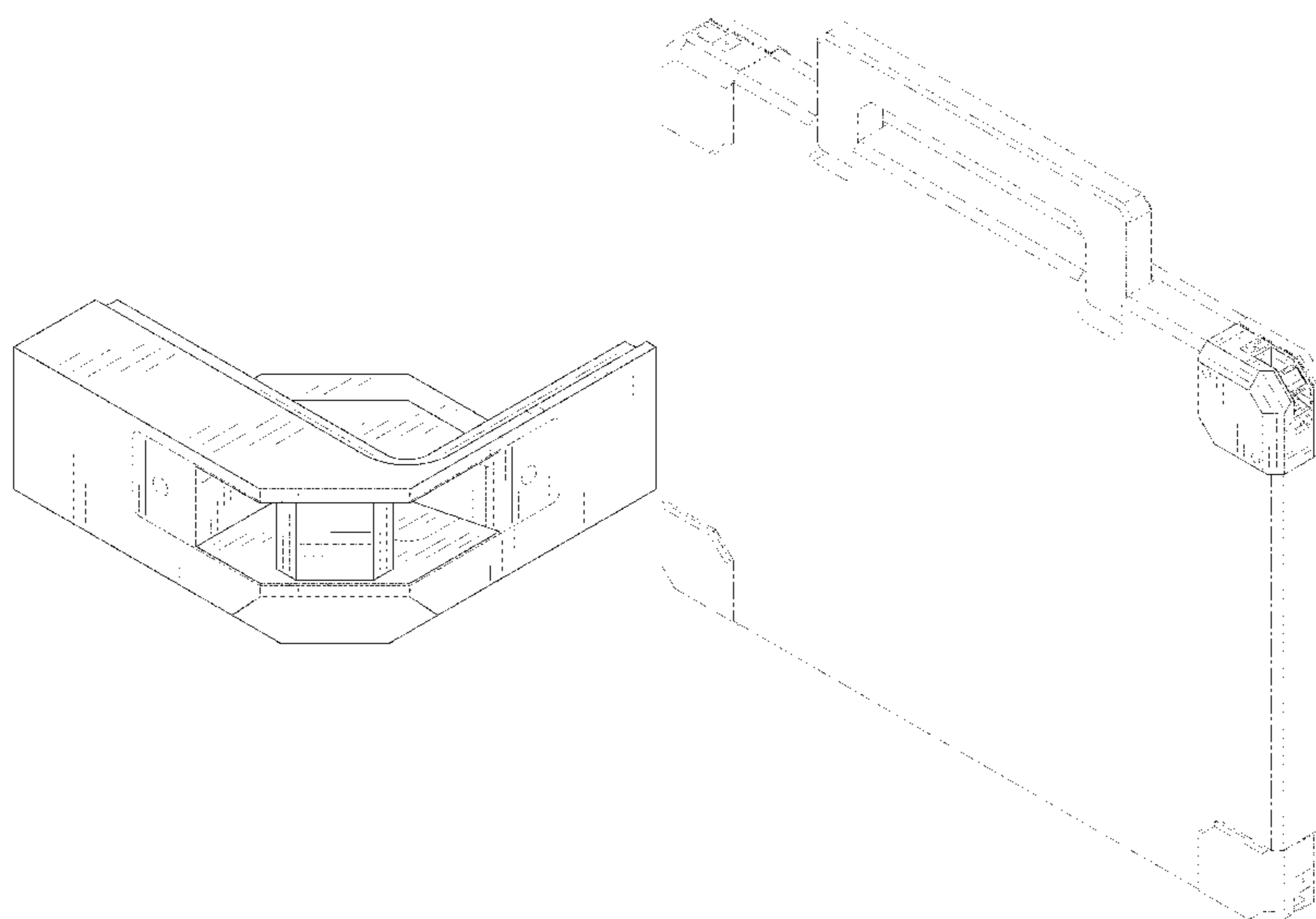

(56)

References Cited

U.S. PATENT DOCUMENTS

10,928,862	B2 *	2/2021	Chen	G06F 1/1615
2015/0194993	A1 *	7/2015	Sajady	H04B 1/3888
				455/575.1

* cited by examiner

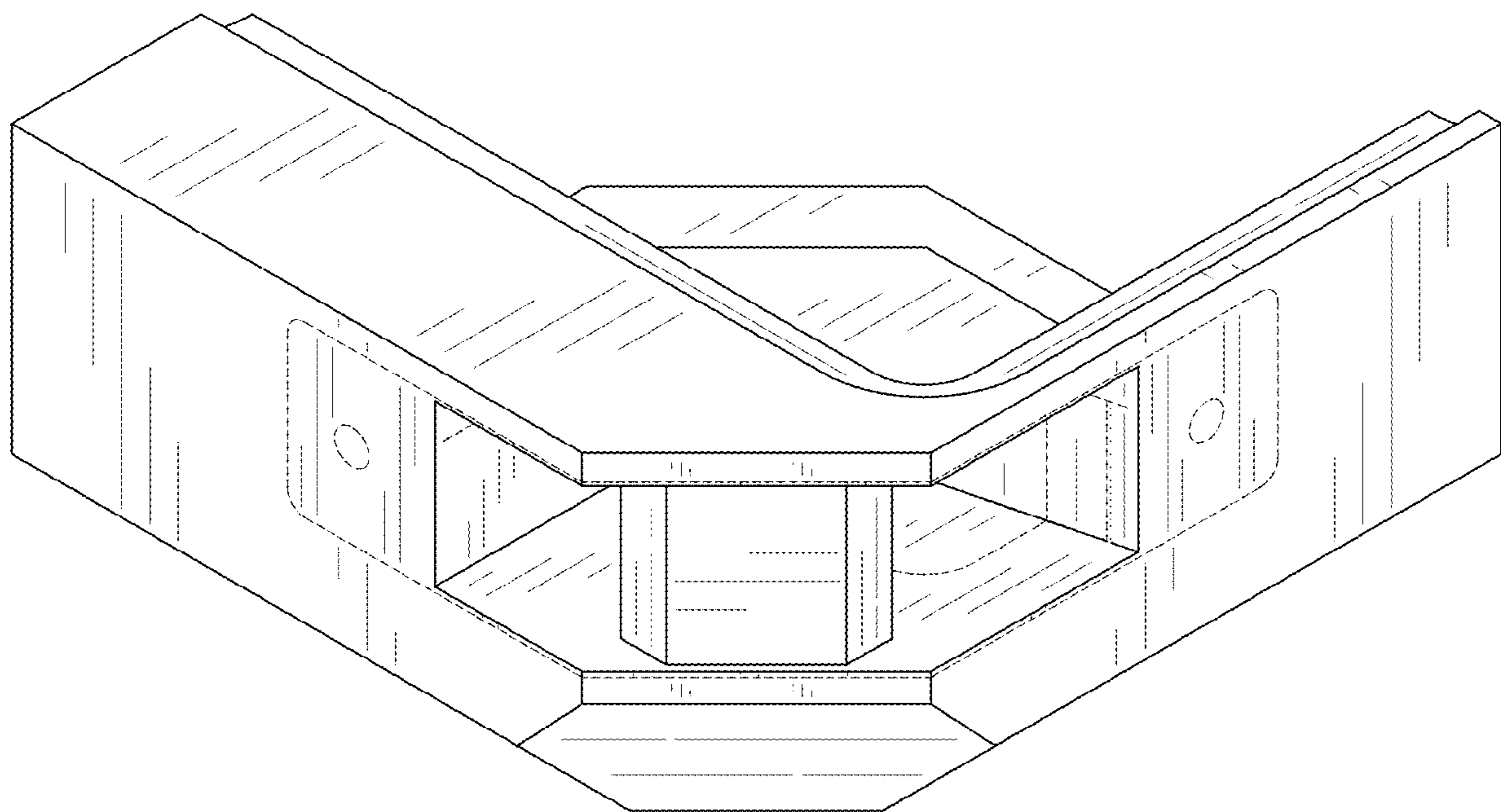

FIG. 1

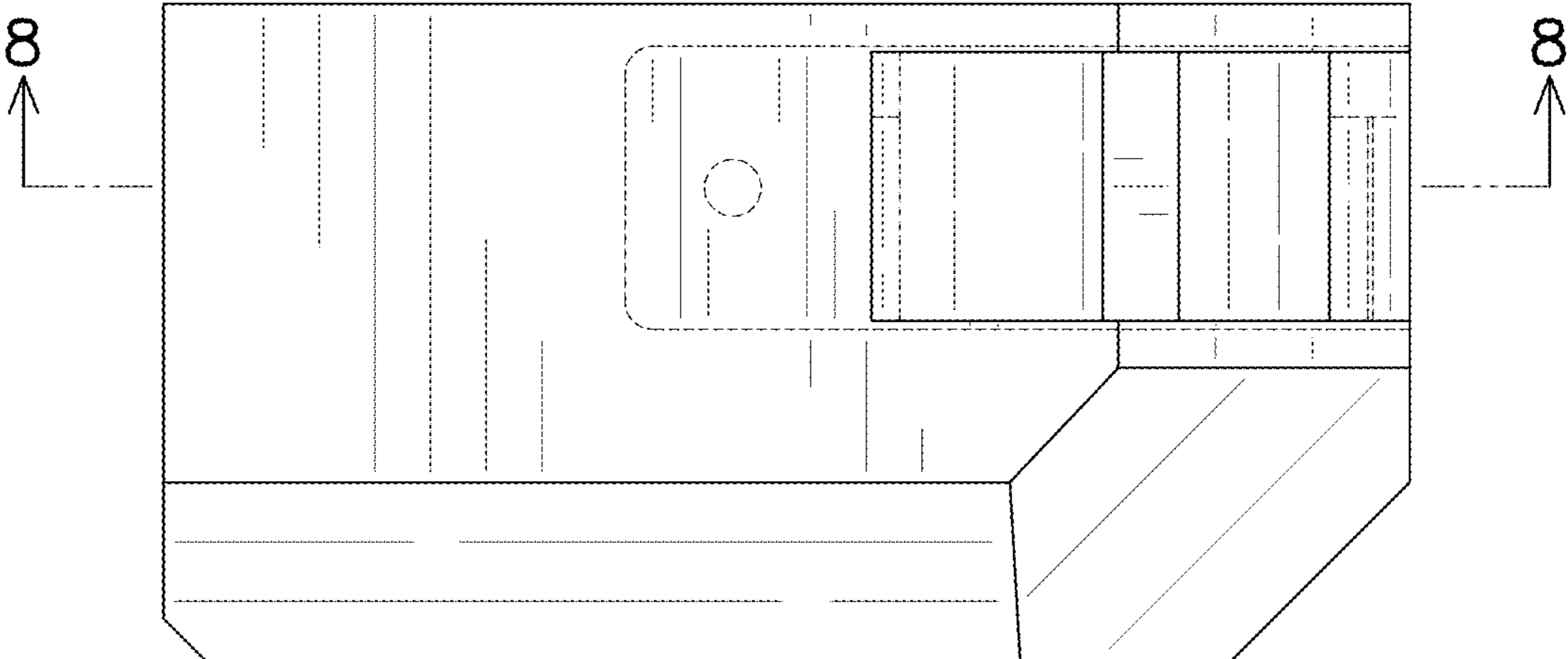

FIG. 2

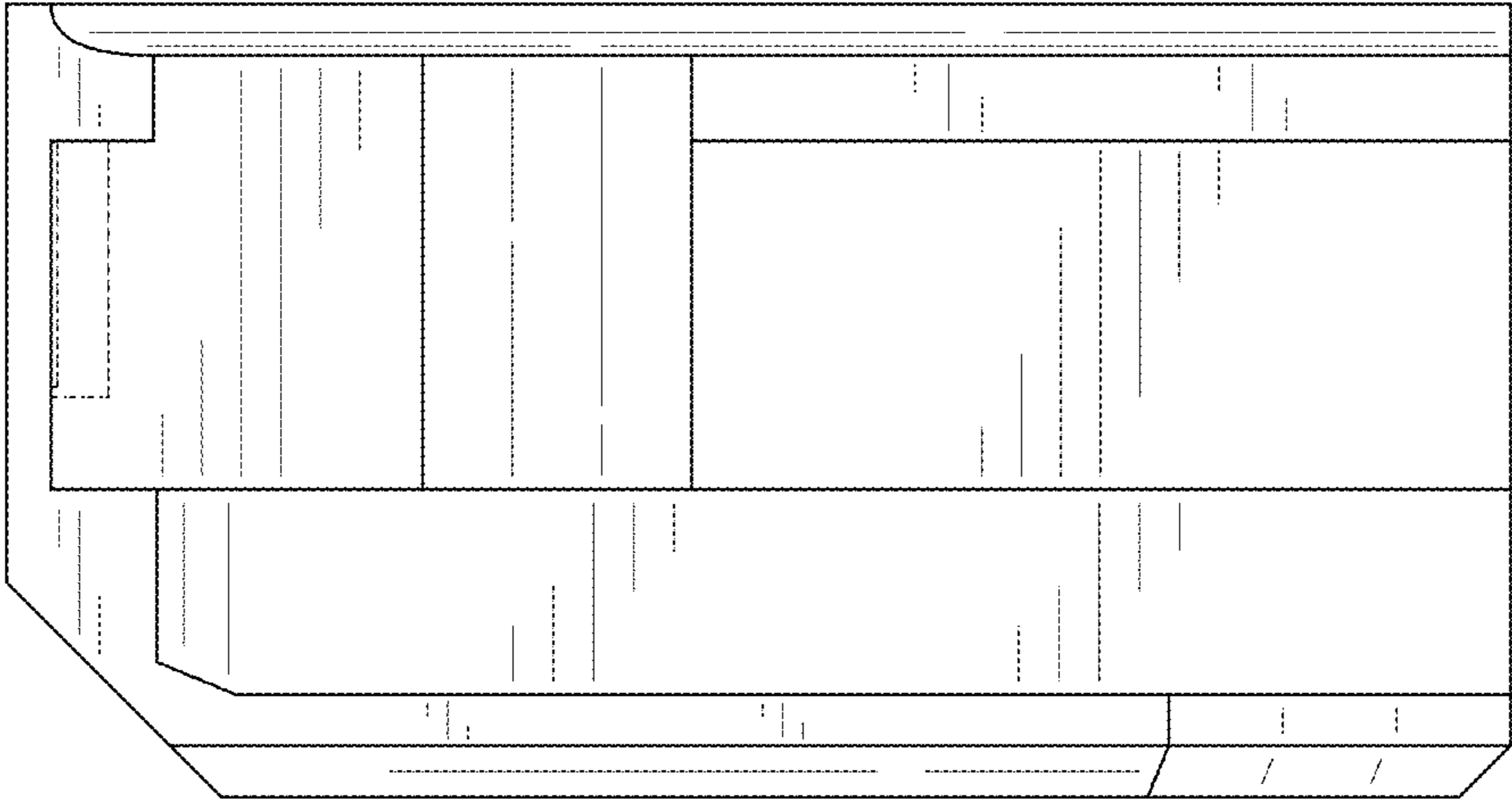

FIG. 3

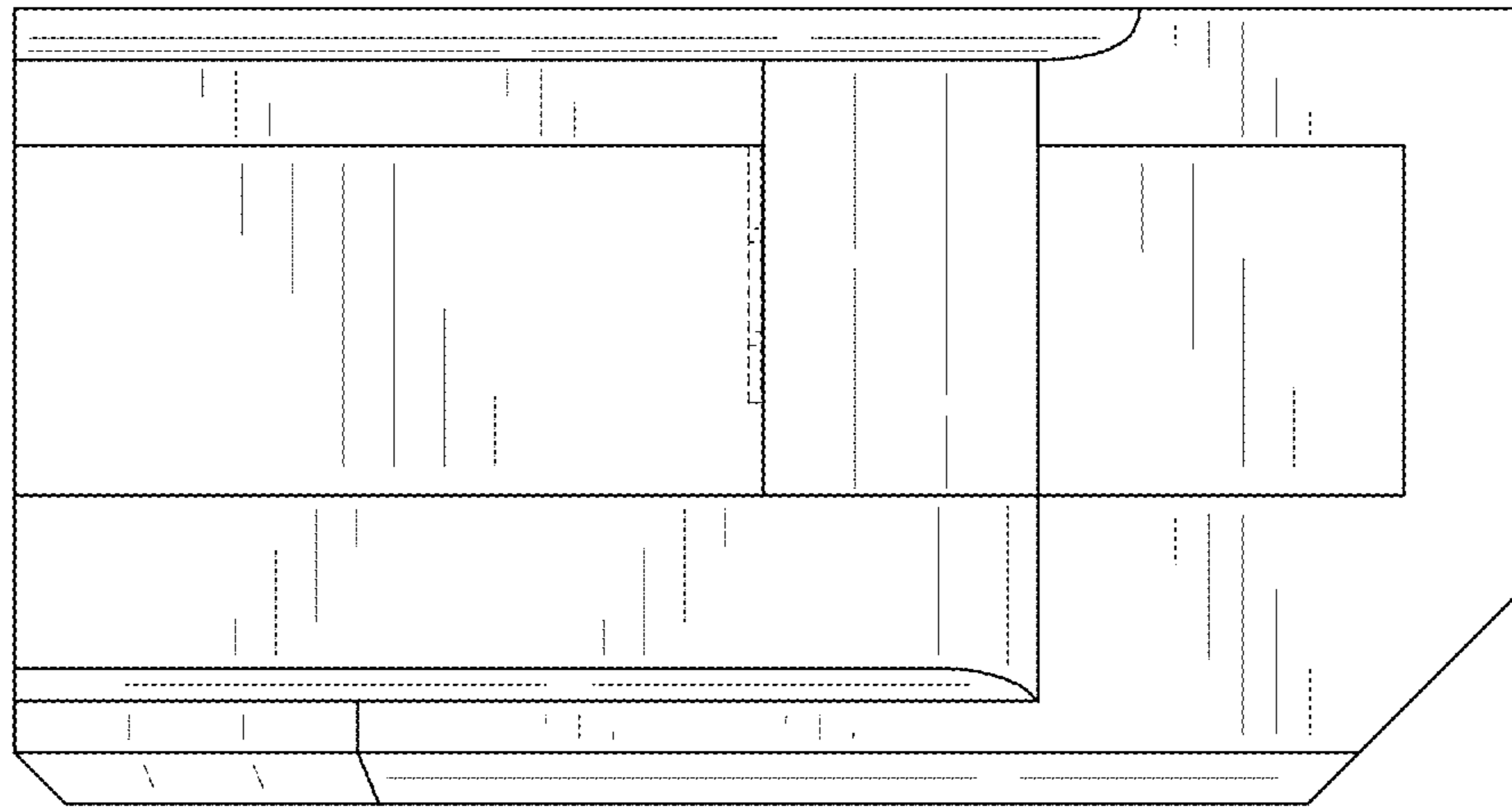

FIG. 4

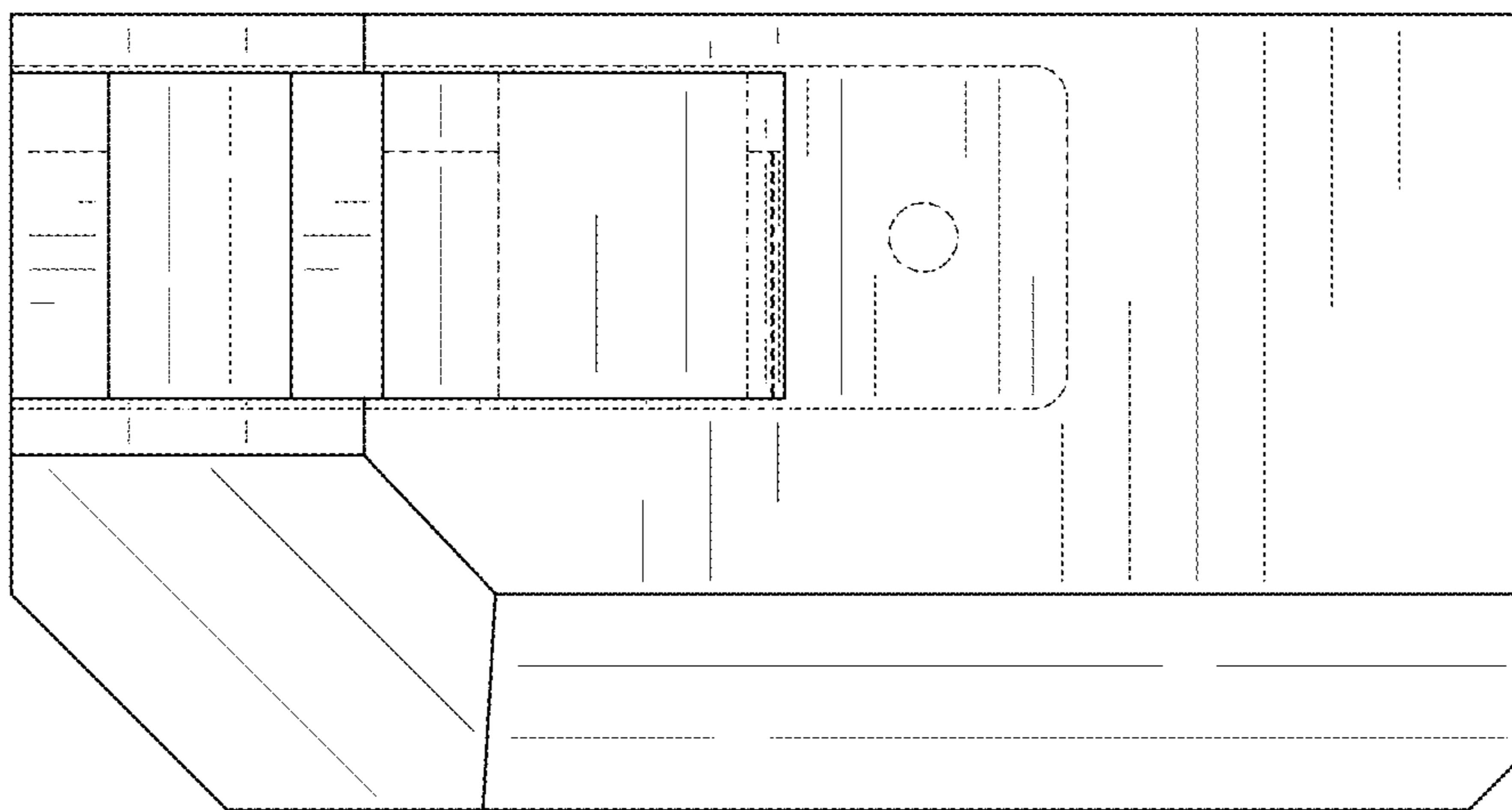

FIG. 5

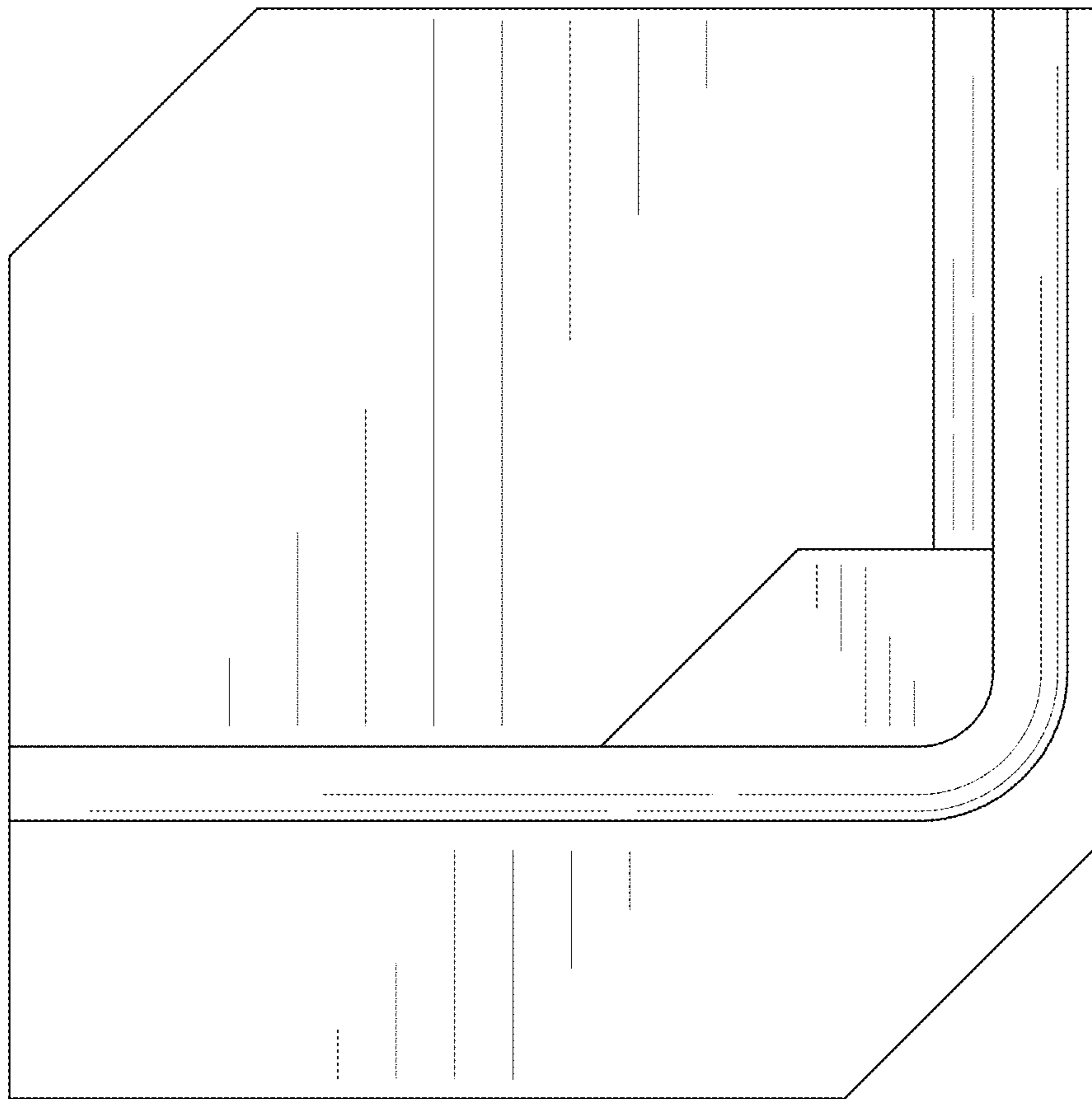

FIG. 6

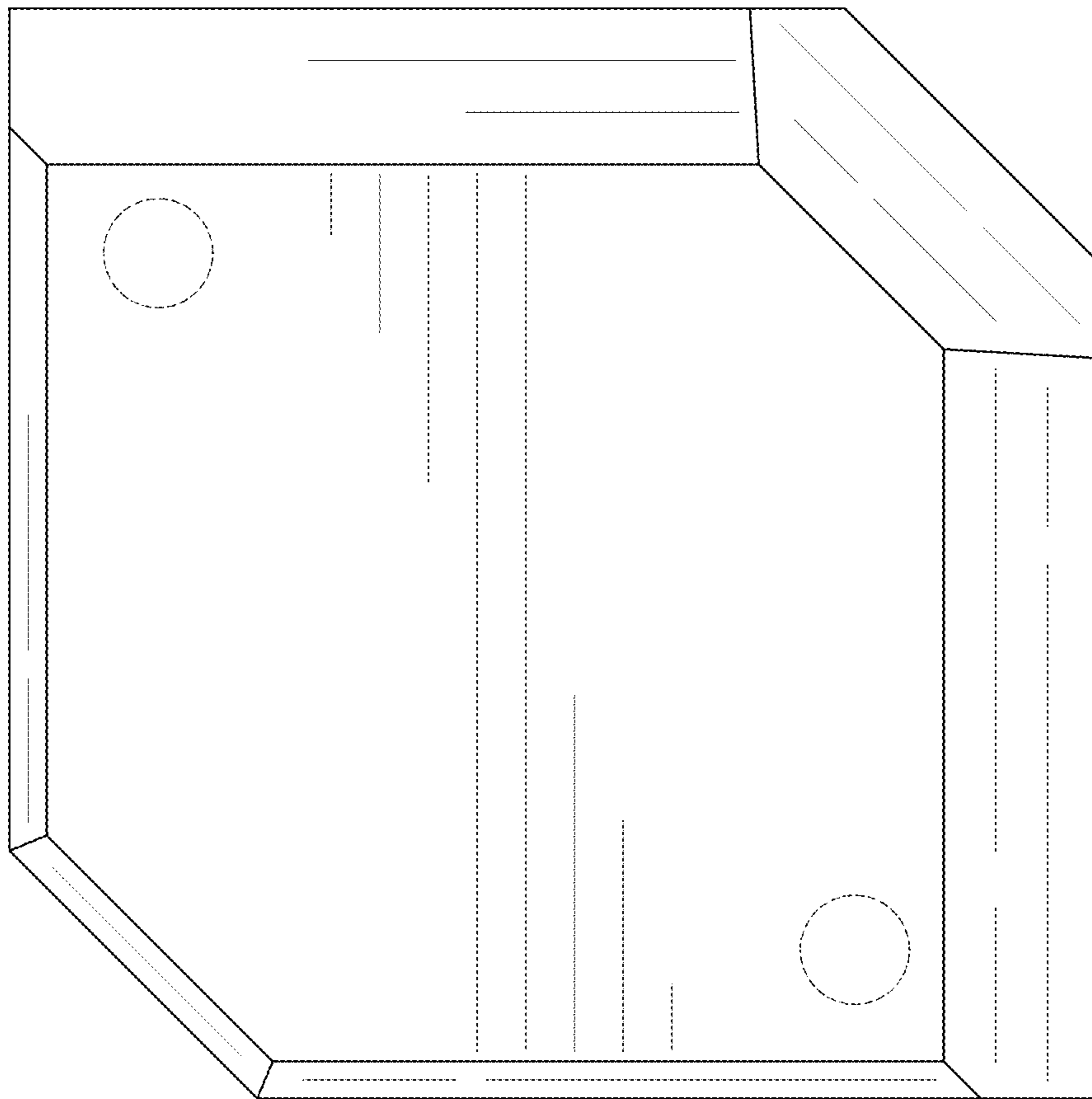

FIG. 7

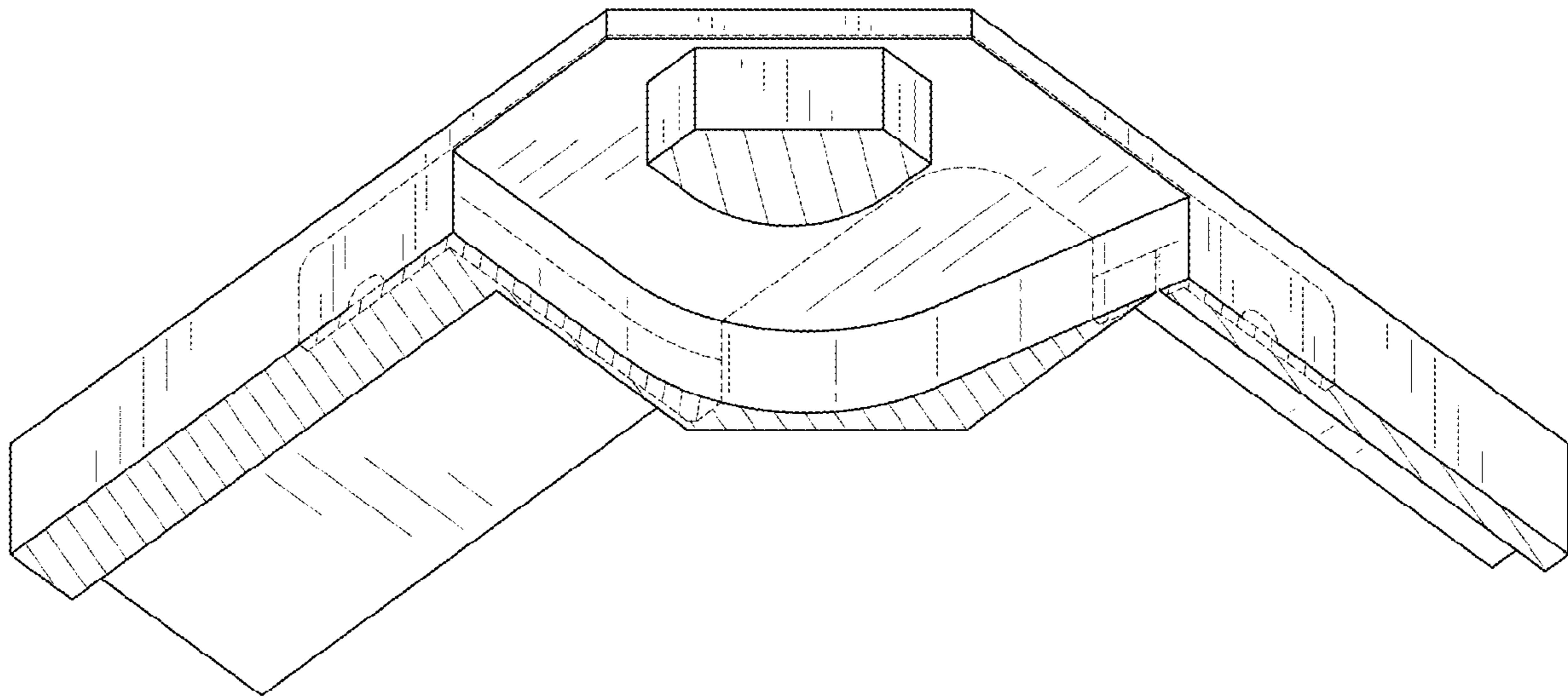

FIG. 8

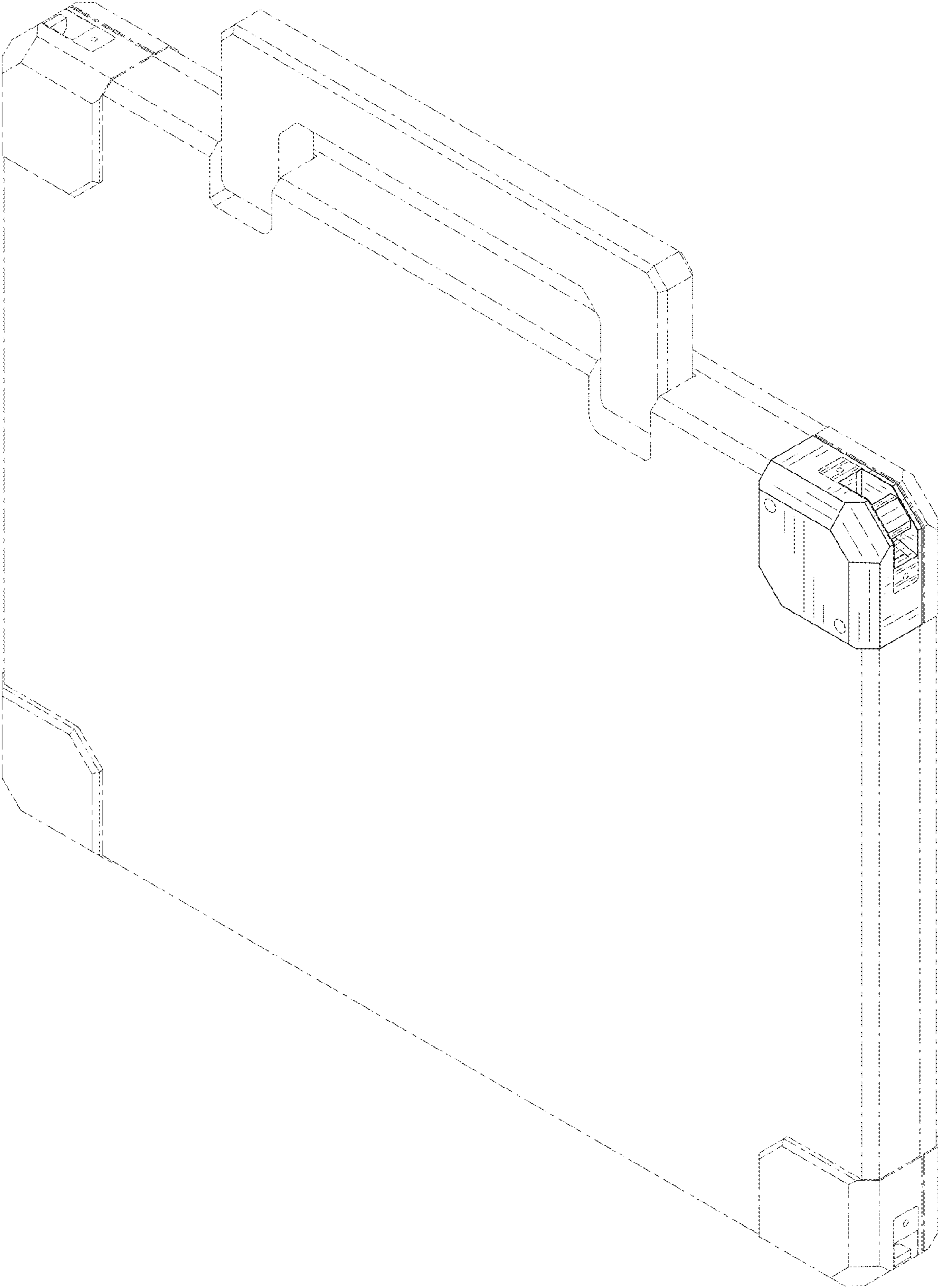

FIG. 9