



US00D939492S

(12) **United States Design Patent** (10) **Patent No.:** **US D939,492 S**
Kim et al. (45) **Date of Patent:** **** Dec. 28, 2021**

(54) **CASE FOR ELECTRONIC DEVICE**

(71) Applicant: **Samsung Electronics Co., Ltd.**,
Suwon-si (KR)

(72) Inventors: **Eunsoo Kim**, Suwon-si (KR); **Junyong Song**, Suwon-si (KR); **Byoungjin Kim**, Suwon-si (KR); **Junghyun Choi**, Suwon-si (KR)

(73) Assignee: **SAMSUNG ELECTRONICS CO., LTD.**, Suwon-si (KR)

(**) Term: **15 Years**

(21) Appl. No.: **29/754,604**

(22) Filed: **Oct. 13, 2020**

(30) **Foreign Application Priority Data**

Apr. 27, 2020 (KR) 30-2020-0018521
Aug. 13, 2020 (KR) 30-2020-0037916

(51) **LOC (13) Cl.** **14-03**

(52) **U.S. Cl.**
USPC **D14/250**

(58) **Field of Classification Search**
USPC D14/203.3–203.7, 439, 251–253, 447,
D14/217, 240, 238.1, 250, 440, 248;
D13/103, 107–108, 119; D3/201, 218,
D3/247, 249, 269, 273, 301, 303
CPC . H04B 1/3888; A45C 13/02; A45C 2011/002;
A45C 1/06; A45C 11/00; A45F 2005/026;
A45F 2200/0525; A45F 2200/0516;
H04M 1/0283; H04M 1/0202
See application file for complete search history.

(56) **References Cited**

U.S. PATENT DOCUMENTS

D414,033 S * 9/1999 Rohm D3/249
D582,405 S * 12/2008 Andre D3/299

D641,348 S * 7/2011 Kim D14/250
D657,354 S * 4/2012 Kim D14/250
D674,799 S * 1/2013 Kim D14/440
D685,800 S * 7/2013 Canizares D14/440
D702,673 S * 4/2014 Murchison D14/250
D712,393 S * 9/2014 Kim D14/250

(Continued)

Primary Examiner — Carla J Wright
(74) *Attorney, Agent, or Firm* — McAndrews Held & Malloy, Ltd.

(57) **CLAIM**

The ornamental design for a case for electronic device, as shown and described.

DESCRIPTION

FIG. 1 is a front perspective view of a case for electronic device showing our new design according to a first embodiment;
FIG. 2 is a front elevation view thereof;
FIG. 3 is a rear elevation view thereof;
FIG. 4 is a left side elevation view thereof;
FIG. 5 is a right side elevation view thereof;
FIG. 6 is a top plan view thereof;
FIG. 7 is a bottom plan view thereof;
FIG. 8 is a rear perspective view thereof;
FIG. 9 is a front perspective view of a case for electronic device showing our new design according to a second embodiment;
FIG. 10 is a front elevation view thereof;
FIG. 11 is a rear elevation view thereof;
FIG. 12 is a left side elevation view thereof;
FIG. 13 is a right side elevation view thereof;
FIG. 14 is a top plan view thereof;
FIG. 15 is a bottom plan view thereof; and,
FIG. 16 is a rear perspective view thereof.
The broken lines in the drawing figures illustrate portions of the case for electronic device that form no part of the embodiment of the claimed design in which they are shown.

1 Claim, 14 Drawing Sheets

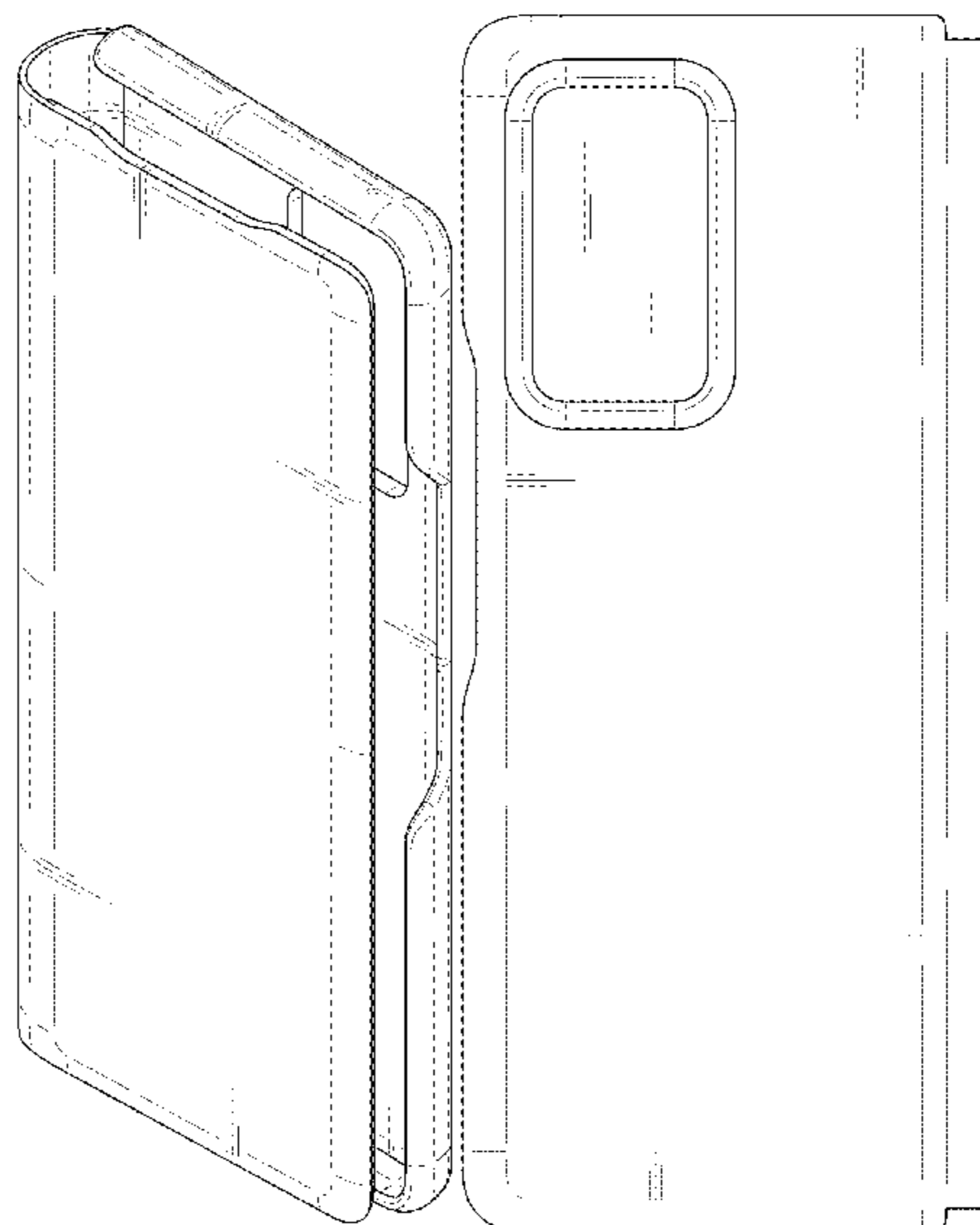

(56)

References Cited

U.S. PATENT DOCUMENTS

D713,834	S *	9/2014	Almstrom	D14/250
D714,053	S *	9/2014	Yoo	D3/269
D723,038	S *	2/2015	Kim	D14/440
D729,812	S *	5/2015	Ahn	D14/440
D738,620	S *	9/2015	Schmole	D3/249
D757,431	S *	5/2016	Requa	D3/247
D762,205	S *	7/2016	Dang	D14/250
D762,615	S *	8/2016	Kim	D14/203.4
D764,450	S *	8/2016	Lee	D14/250
D765,626	S *	9/2016	Tattari	D14/250
D769,853	S *	10/2016	Kim	D14/250
D777,159	S *	1/2017	Lee	D14/250
D791,758	S *	7/2017	Lee	D14/250
D794,627	S *	8/2017	Roberts	D14/250
D800,714	S *	10/2017	Lee	D14/250
D800,732	S *	10/2017	Dang	D14/440
D809,497	S *	2/2018	Kim	D14/250
D832,268	S *	10/2018	Mecchella	D14/440
D859,389	S *	9/2019	Kim	D14/250
2011/0290687	A1 *	12/2011	Han	A45C 3/02 206/320
2012/0043247	A1 *	2/2012	Westrup	G06F 1/1633 206/472
2012/0085679	A1 *	4/2012	Kim	A45C 3/001 206/736

* cited by examiner

FIG. 1

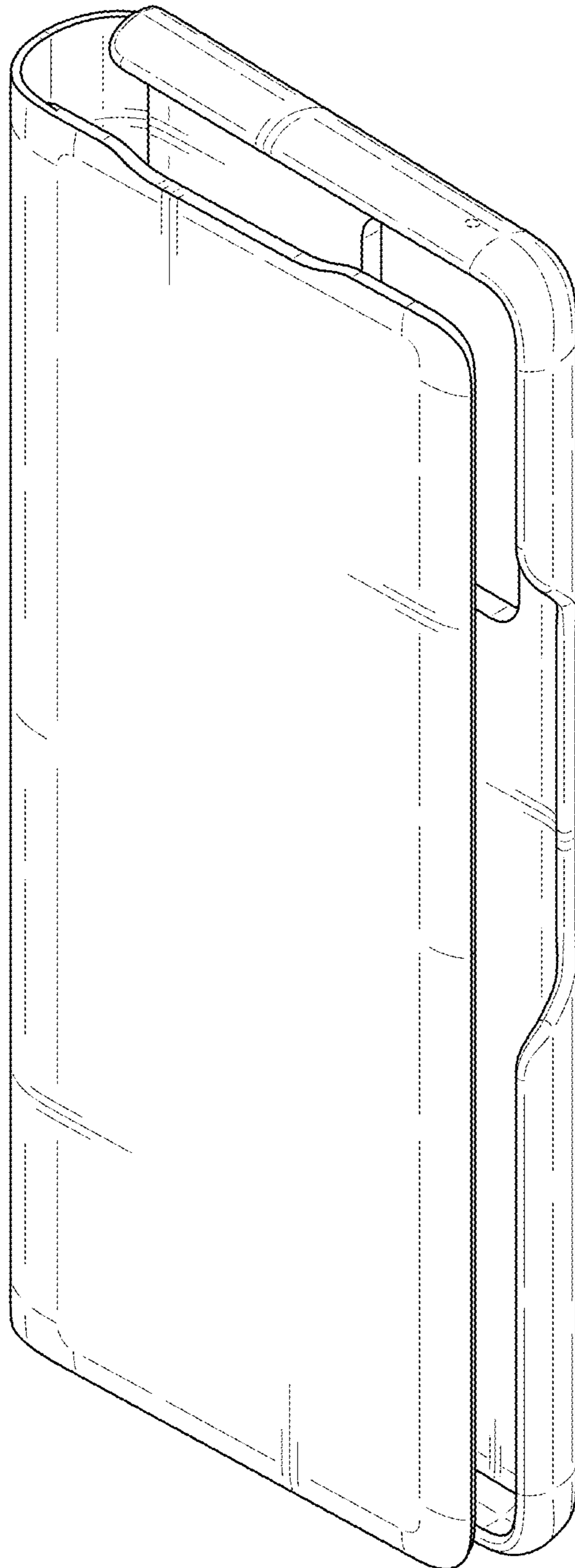

FIG. 2

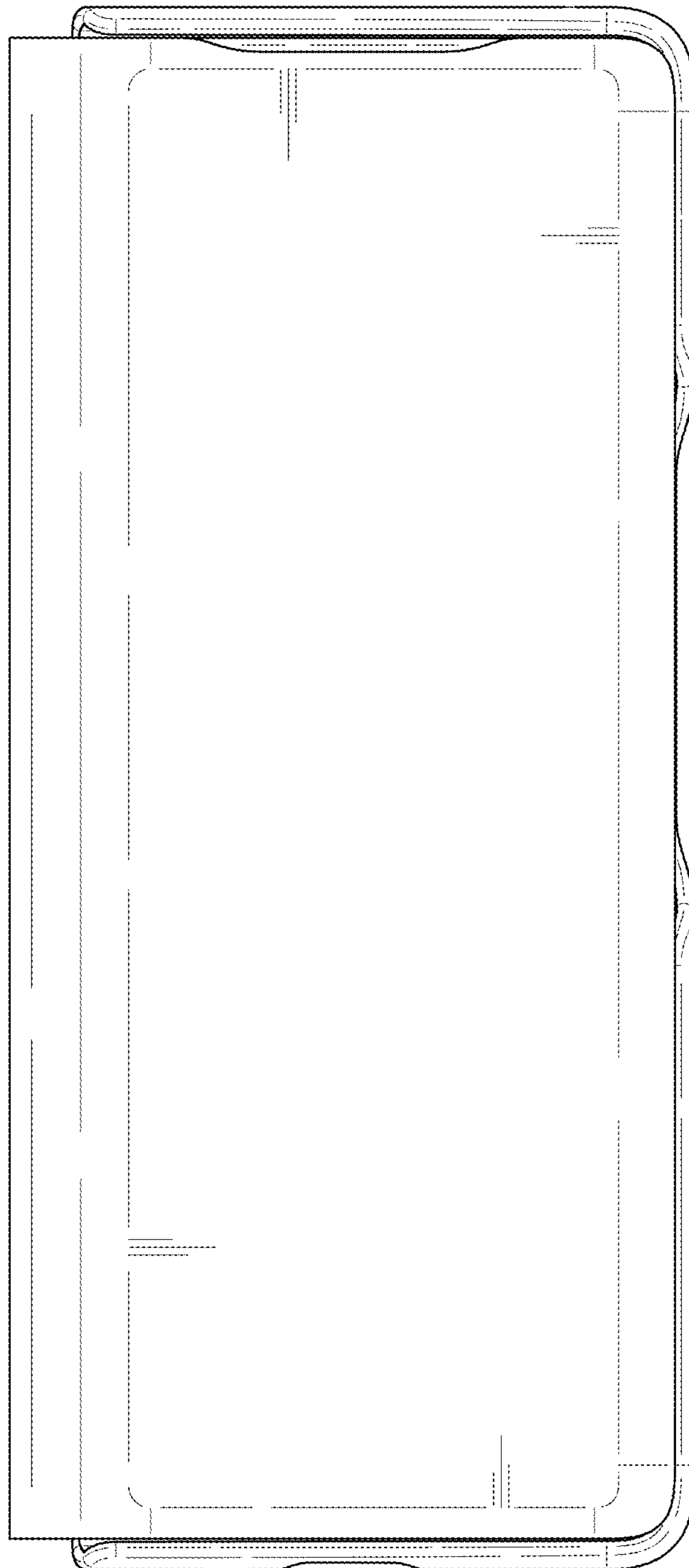

FIG. 3

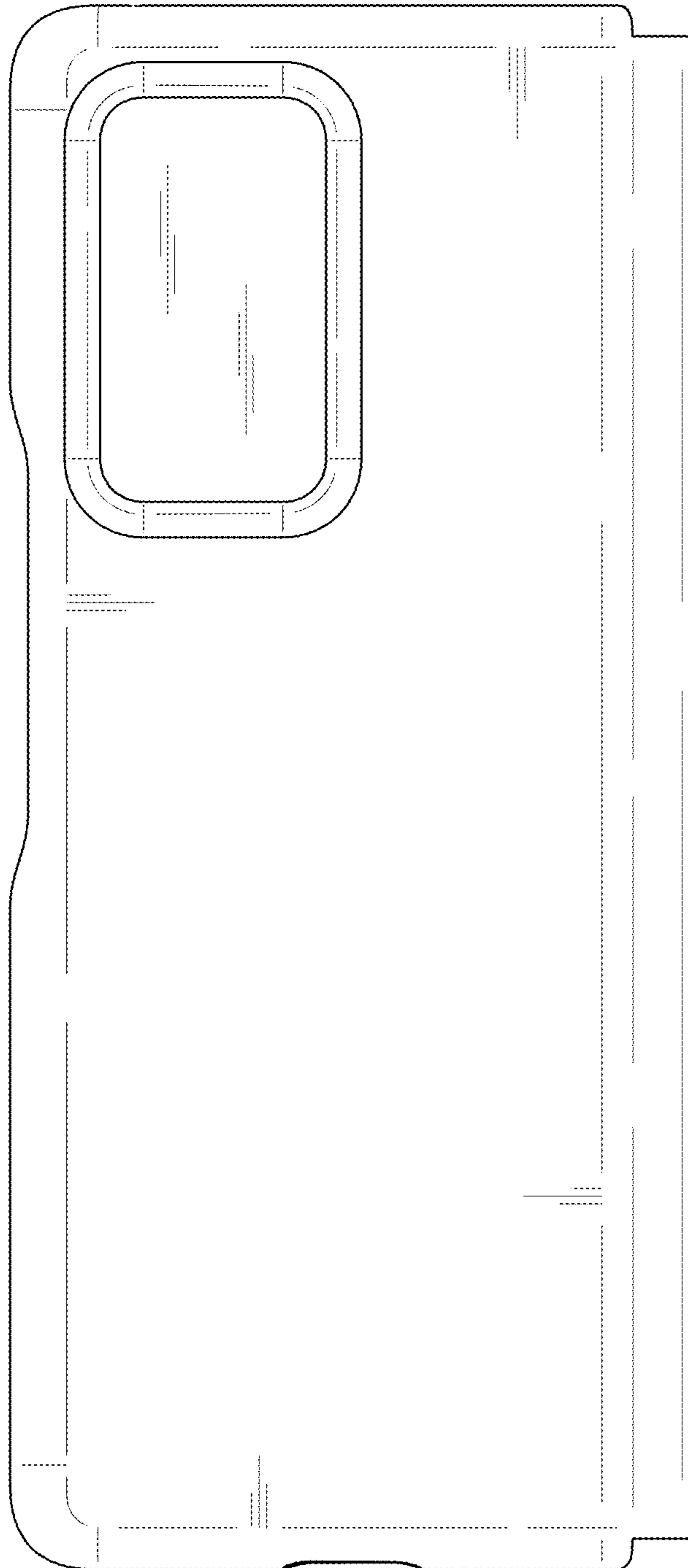

FIG. 4

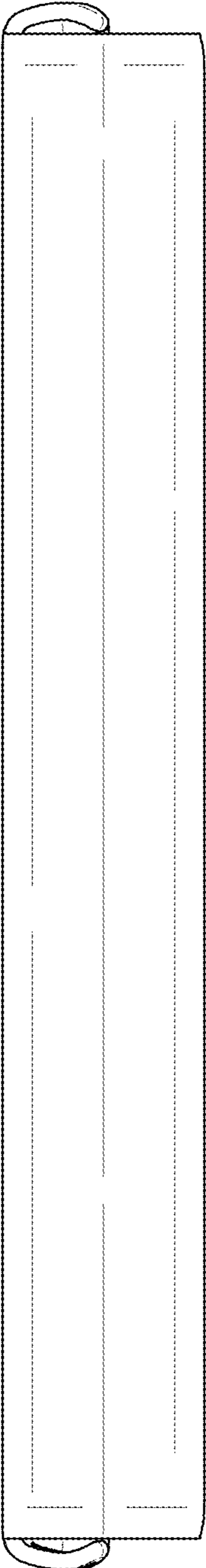

FIG. 5

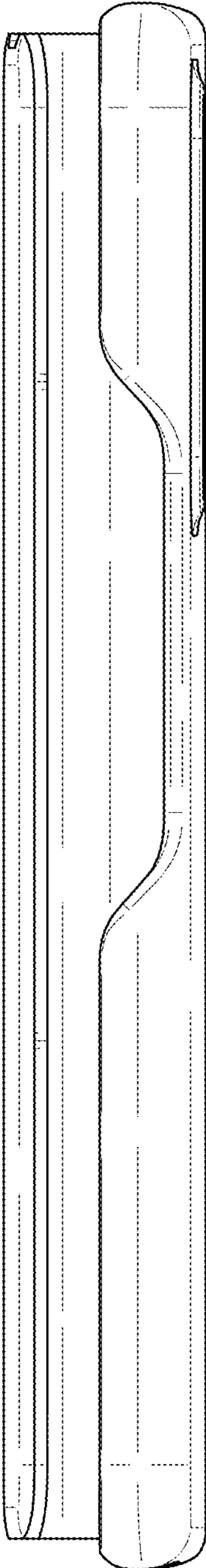

FIG. 6

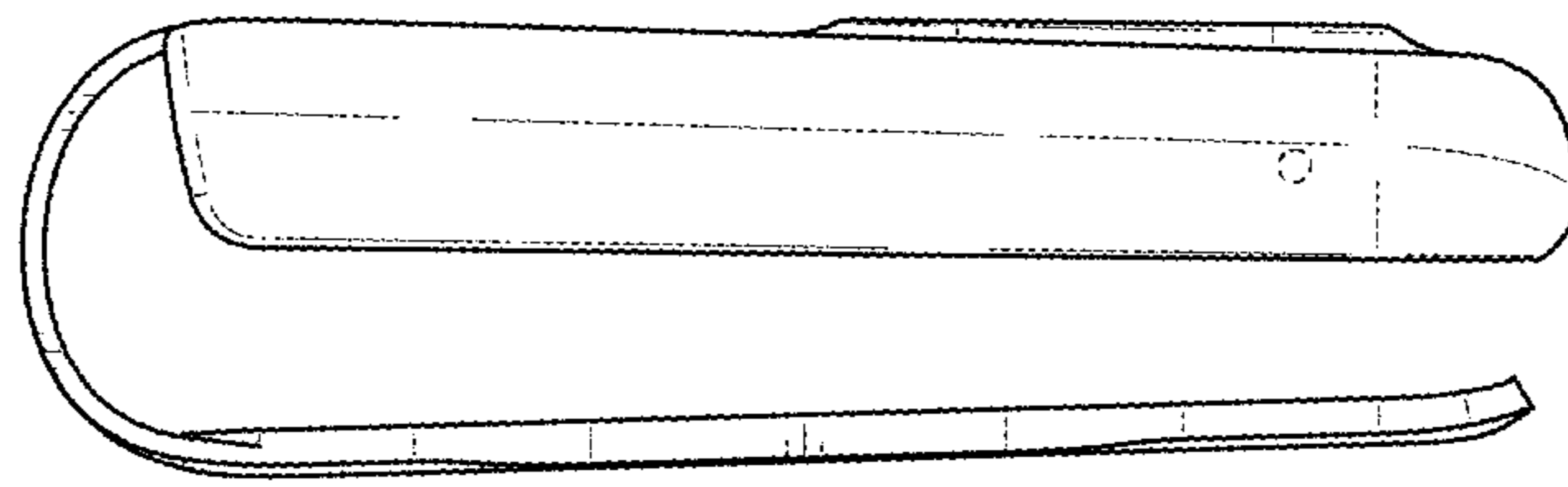

FIG. 7

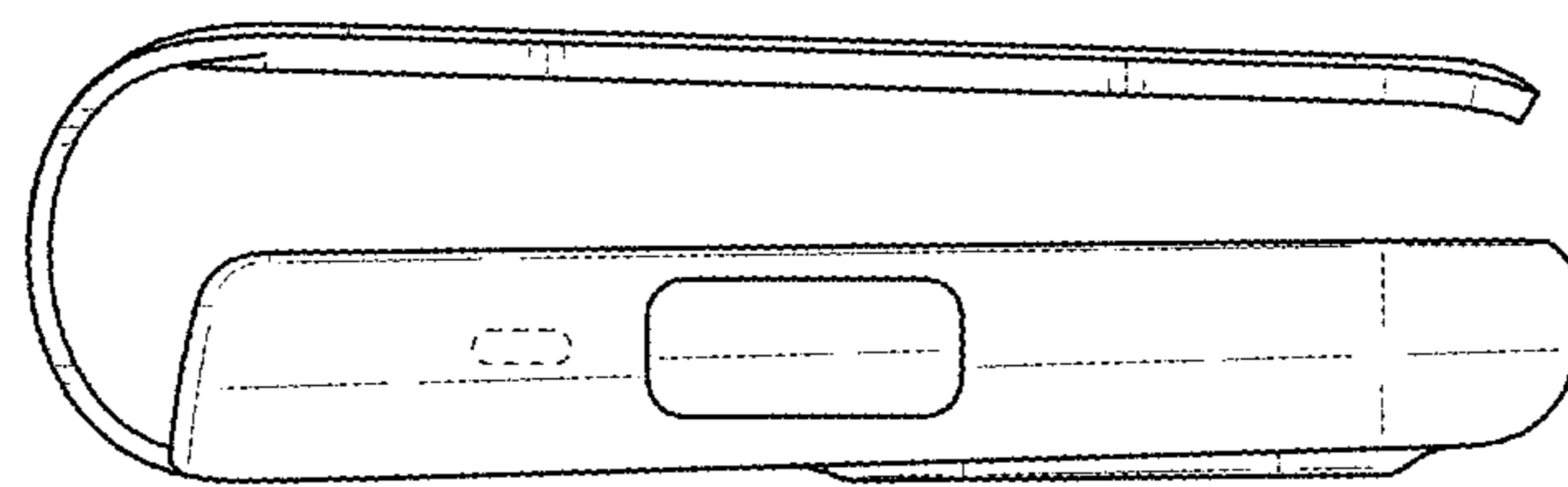

FIG. 8

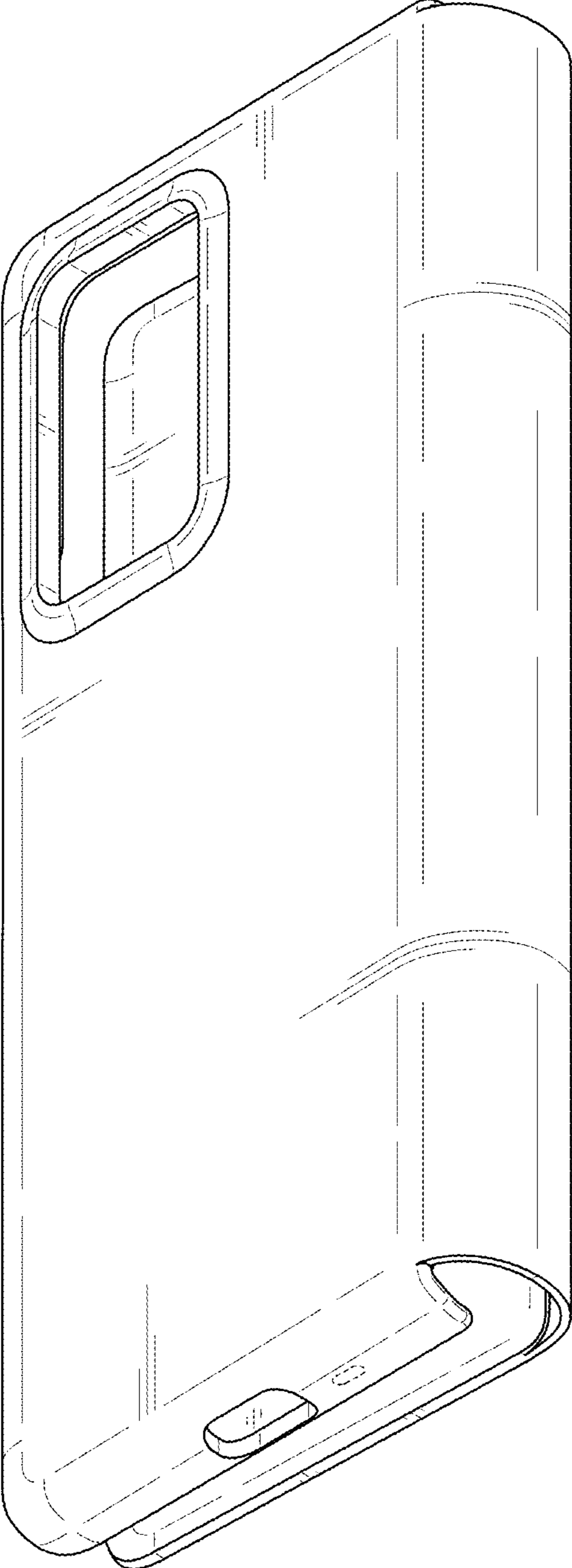

FIG. 9

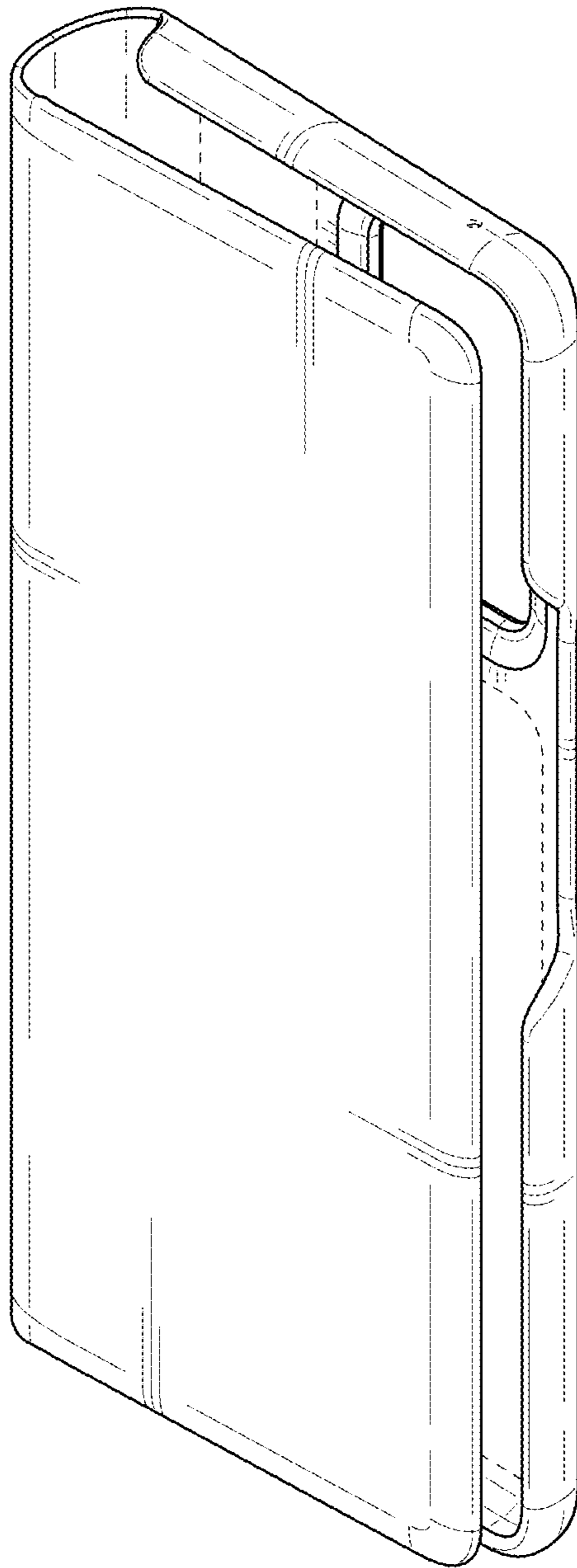

FIG. 10

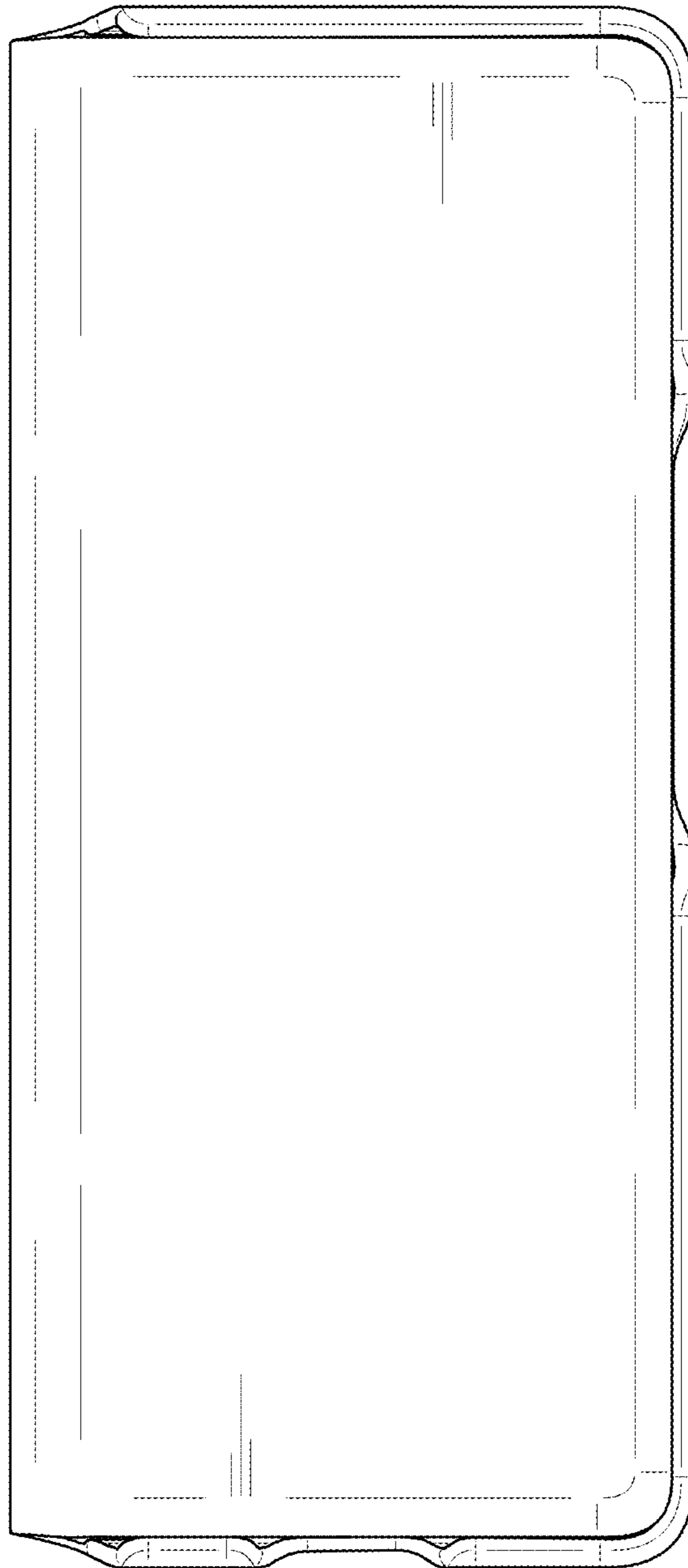

FIG. 11

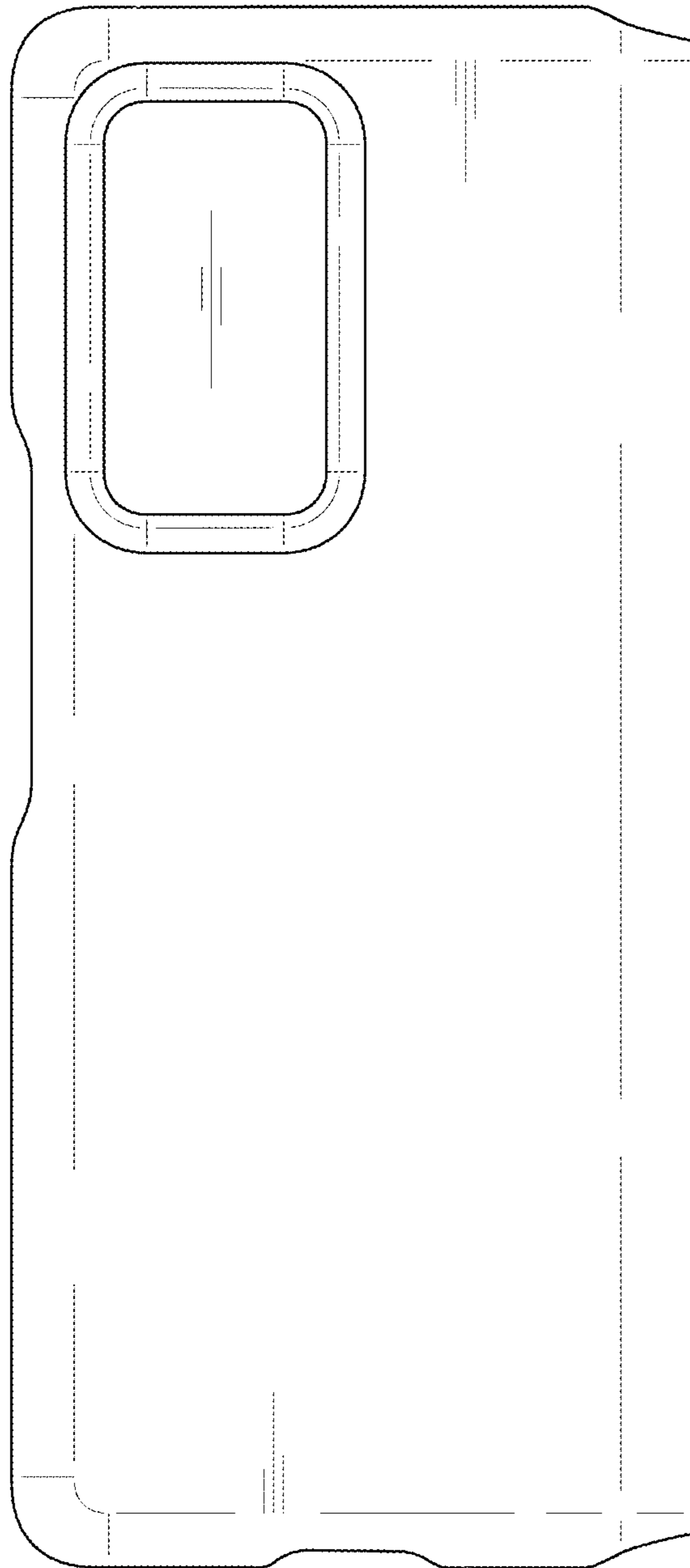

FIG. 12

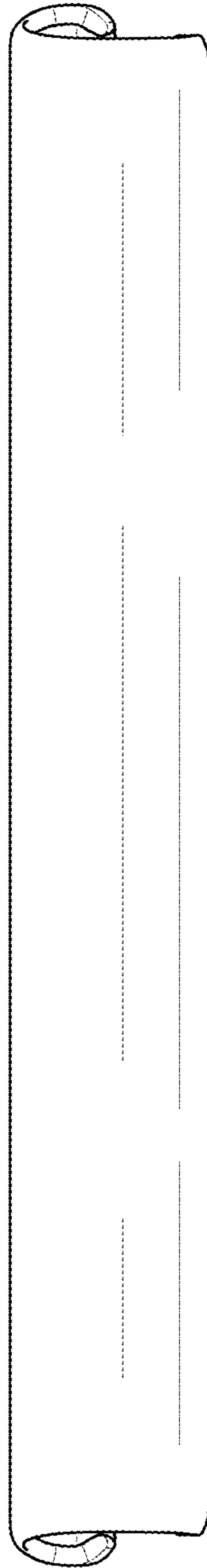

FIG. 13

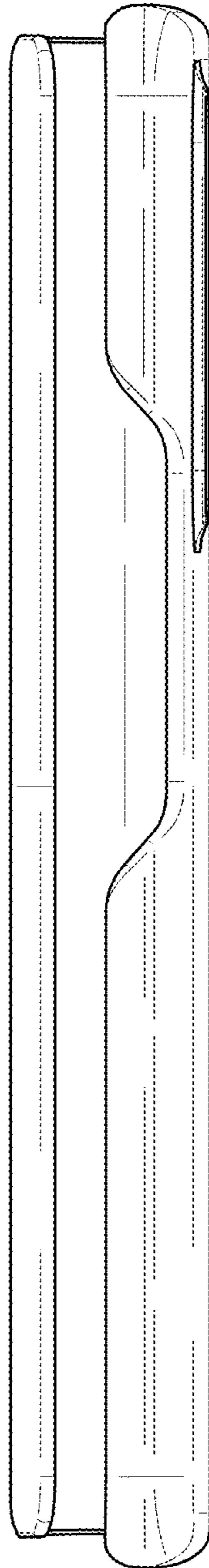

FIG. 14

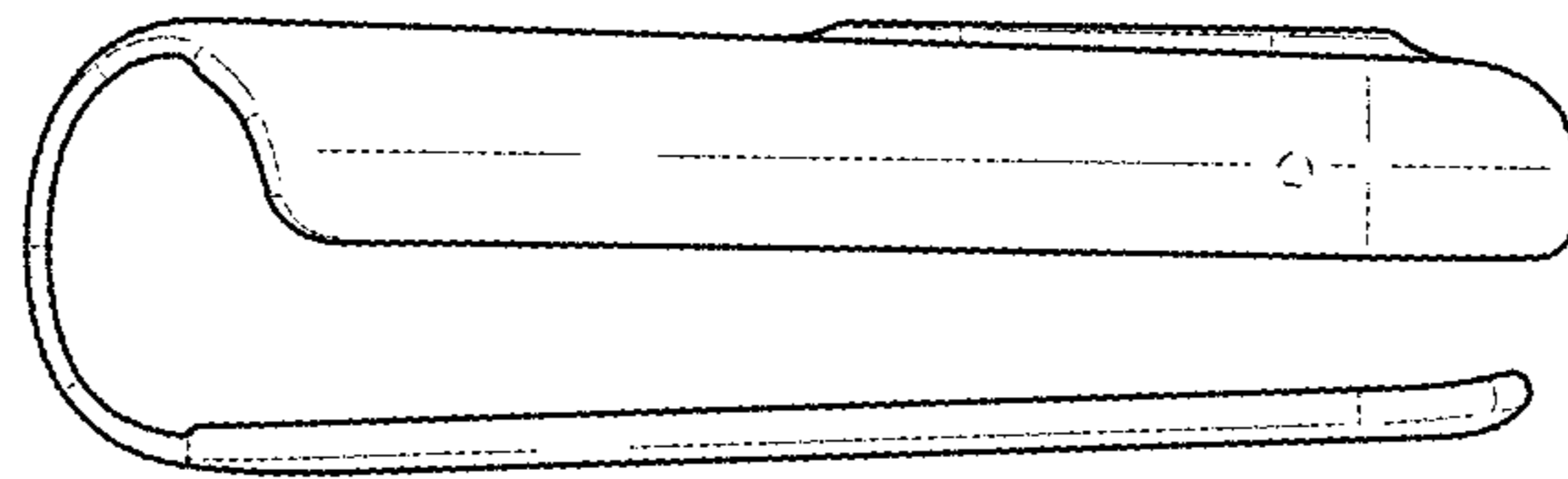

FIG. 15

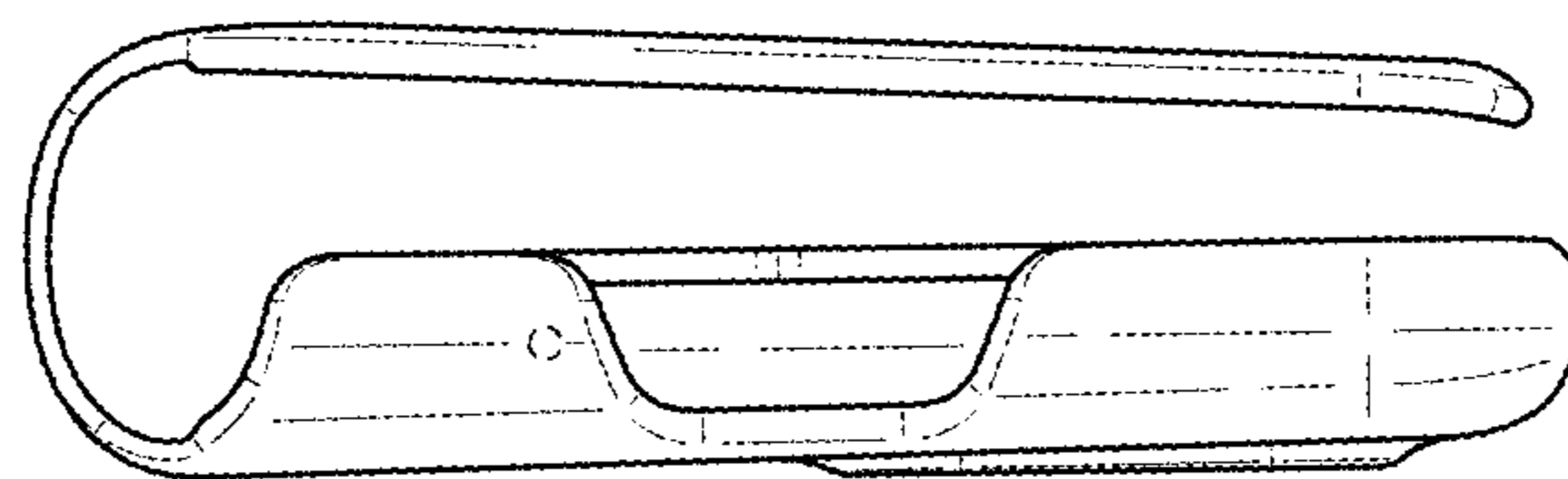

FIG. 16

