



US00D939486S

(12) **United States Design Patent** (10) **Patent No.:** **US D939,486 S**
Kim et al. (45) **Date of Patent:** **** Dec. 28, 2021**

(54) **ELECTRONIC DEVICE**

(71) Applicant: **Samsung Electronics Co., Ltd.**,
Suwon-si (KR)
(72) Inventors: **Chung-Ha Kim**, Suwon-si (KR);
Min-Young Park, Suwon-si (KR);
Ji-Young Lee, Suwon-si (KR); **Jong-Bo Jung**,
Suwon-si (KR); **Hyok-Su Choi**,
Suwon-si (KR)
(73) Assignee: **SAMSUNG ELECTRONICS CO., LTD.**,
Suwon-si (KR)

(**) Term: **15 Years**

(21) Appl. No.: **29/717,589**

(22) Filed: **Dec. 18, 2019**

(30) **Foreign Application Priority Data**

Jul. 9, 2019 (KR) 30-2019-0032706
(51) **LOC (13) Cl.** **14-03**
(52) **U.S. Cl.**
USPC **D14/248**
(58) **Field of Classification Search**
USPC D14/138 G, 248, 138 C, 432, 439, 341,
D14/345, 371, 374, 138 R, 138 AA,
D14/138 AB, 138 AC, 138 AD
(Continued)

(56) **References Cited**

U.S. PATENT DOCUMENTS

D538,773 S * 3/2007 Joung D14/138 AA
D539,257 S * 3/2007 Obata D14/138 AA
(Continued)

FOREIGN PATENT DOCUMENTS

CN 305552725 * 1/2020
CN 306695898 * 7/2021
(Continued)

OTHER PUBLICATIONS

Samsung Galaxy M30s, announced Sep. 18, 2019, [online], [retrieved on Jul. 29, 2021], Retrieved from Internet ,<URL: http://www.gsmarena.com>.*

(Continued)

Primary Examiner — Bridget L Eland
(74) *Attorney, Agent, or Firm* — McAndrews Held & Malloy, Ltd.

(57) **CLAIM**

The ornamental design for an electronic device, as shown and described.

DESCRIPTION

FIG. 1 is a front perspective view of an electronic device showing our new design according to a first embodiment; FIG. 2 is a front elevation view thereof; FIG. 3 is a rear elevation view thereof; FIG. 4 is a left side elevation view thereof; FIG. 5 is a right side elevation view thereof; FIG. 6 is a top plan view thereof; FIG. 7 is a bottom plan view thereof; FIG. 8 is a rear perspective view thereof; FIG. 9 is a front perspective view of an electronic device showing our new design according to a second embodiment; FIG. 10 is a front elevation view thereof; FIG. 11 is a rear elevation view thereof; FIG. 12 is a left side elevation view thereof; FIG. 13 is a right side elevation view thereof; FIG. 14 is a top plan view thereof; FIG. 15 is a bottom plan view thereof; FIG. 16 is a rear perspective view thereof; FIG. 17 is a front perspective view of an electronic device showing our new design according to a third embodiment; FIG. 18 is a front elevation view thereof; FIG. 19 is a rear elevation view thereof; FIG. 20 is a left side elevation view thereof; FIG. 21 is a right side elevation view thereof; FIG. 22 is a top plan view thereof; FIG. 23 is a bottom plan view thereof; and, FIG. 24 is a rear perspective view thereof.

(Continued)

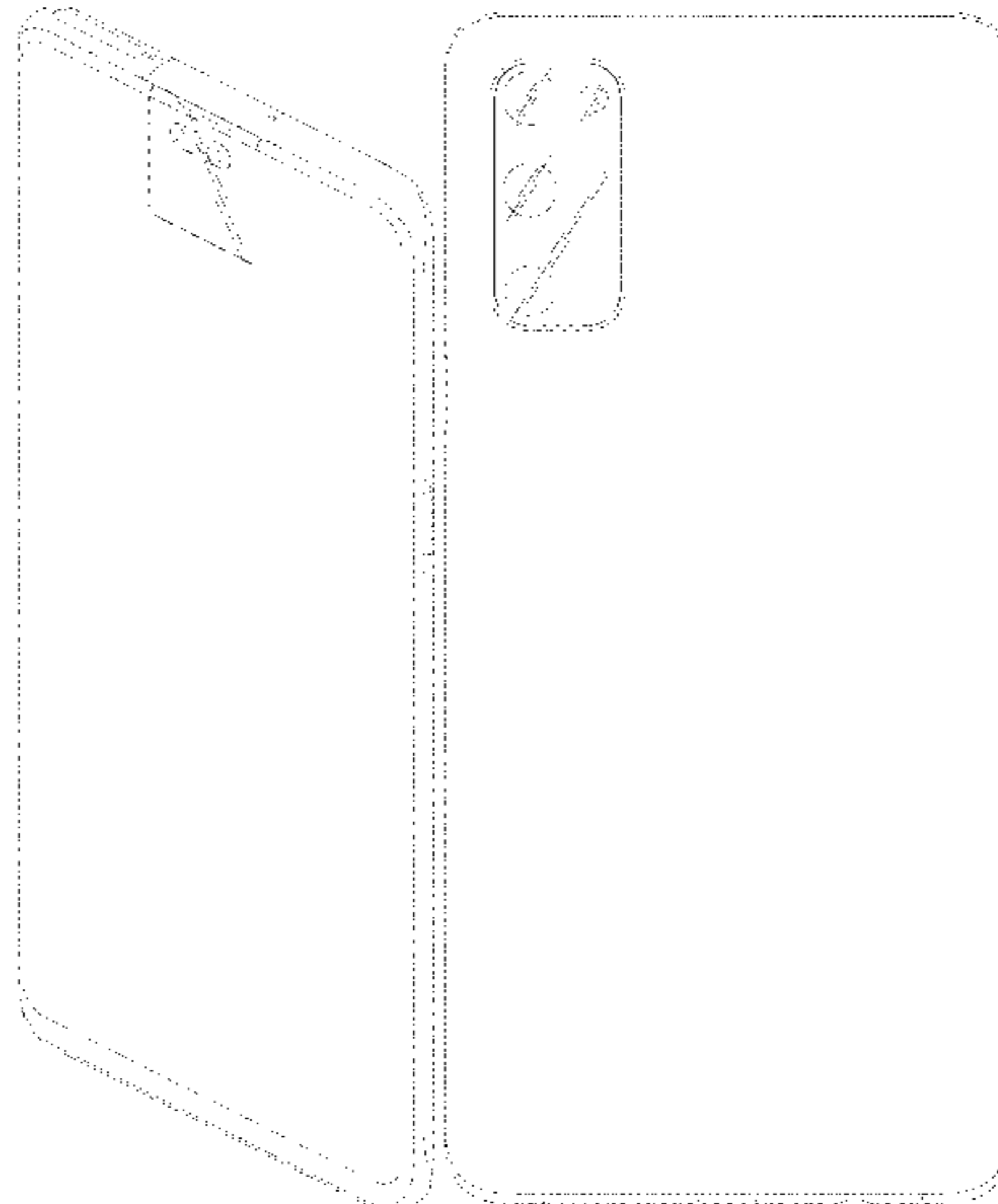

FIG. 1

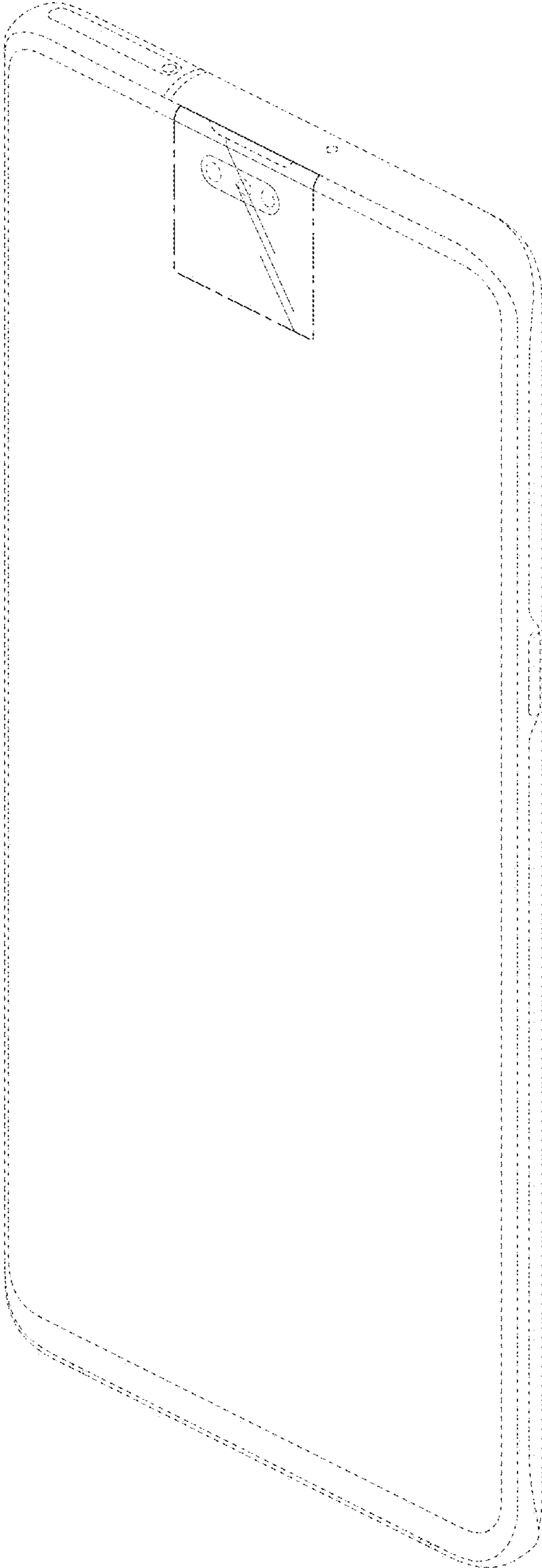

FIG. 2

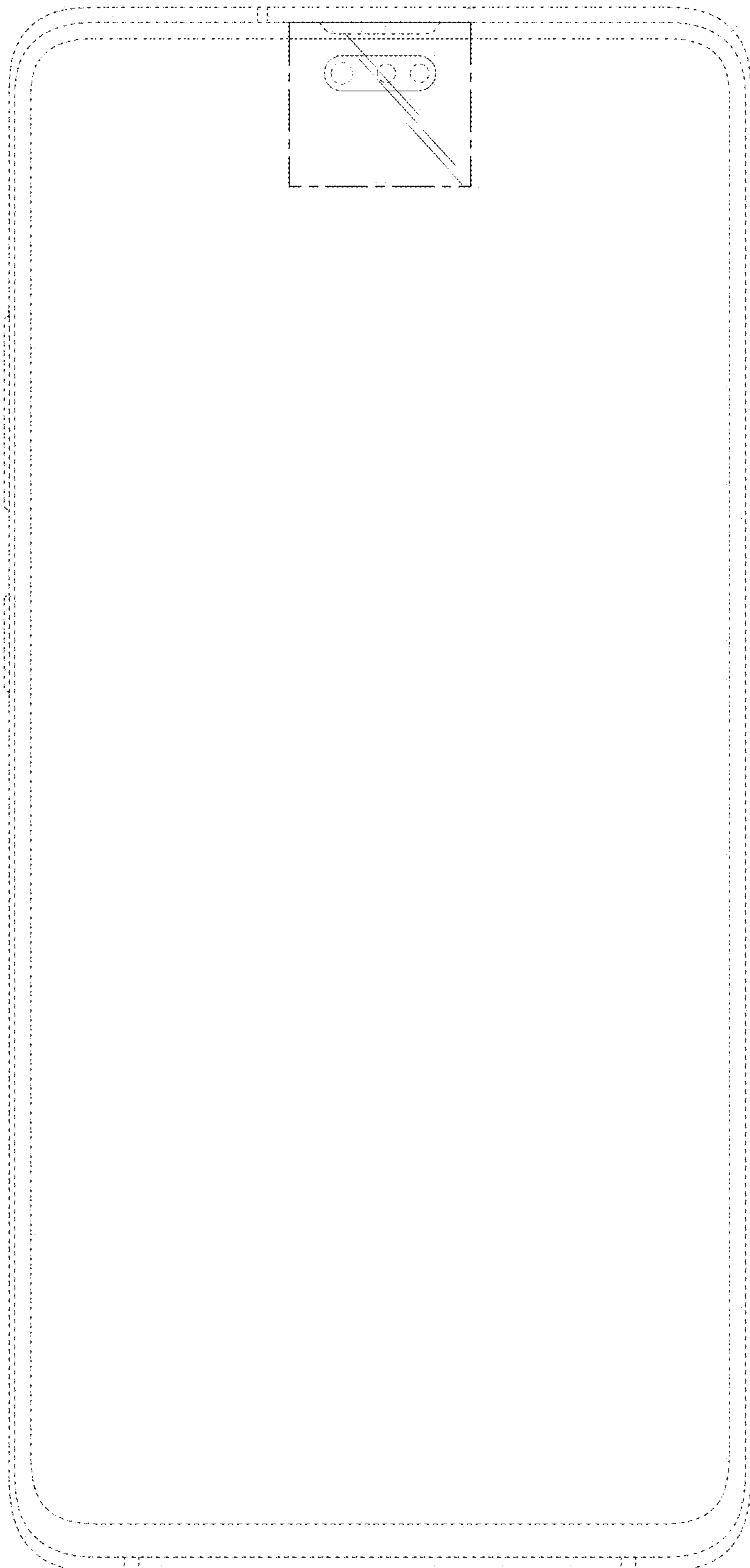

FIG. 3

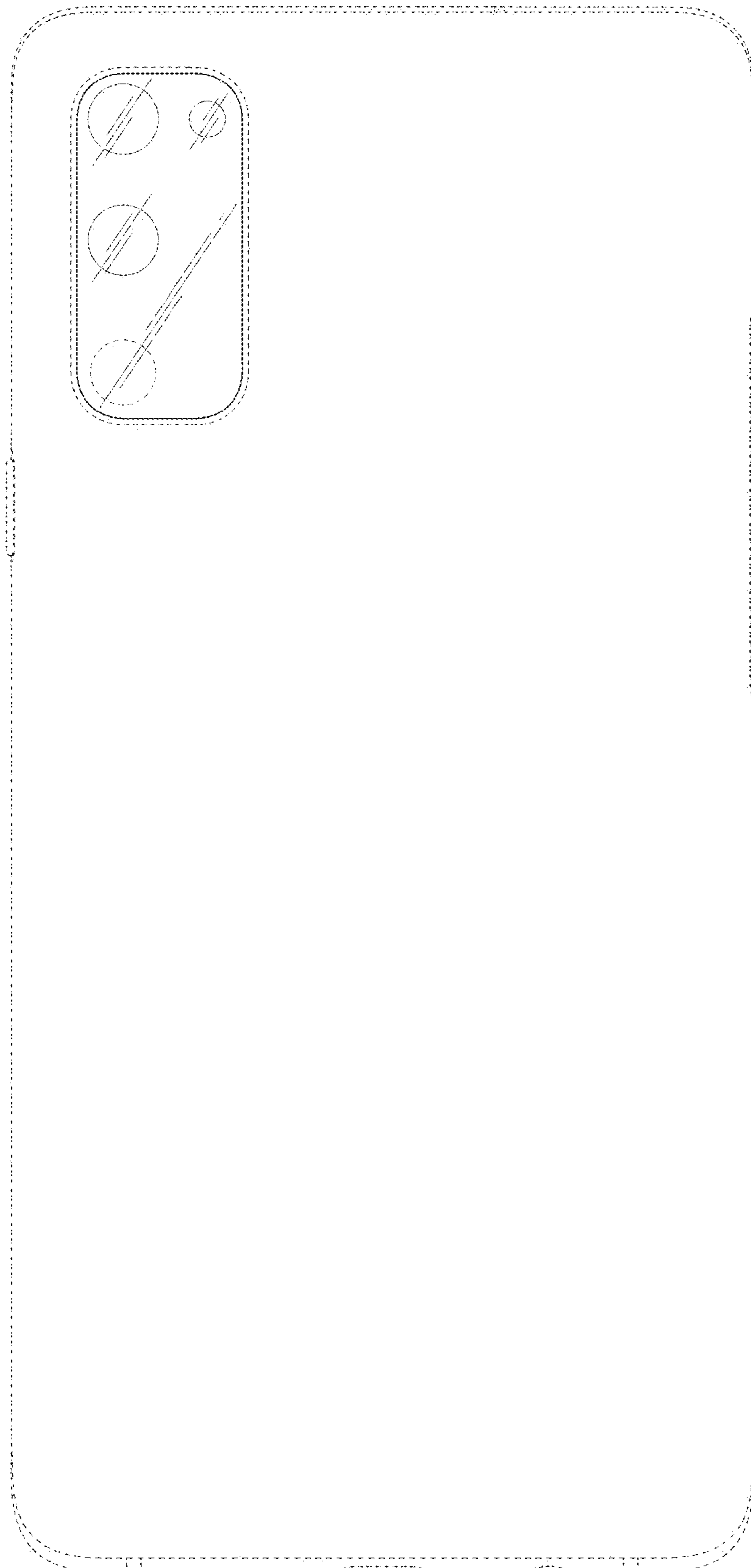

FIG. 4

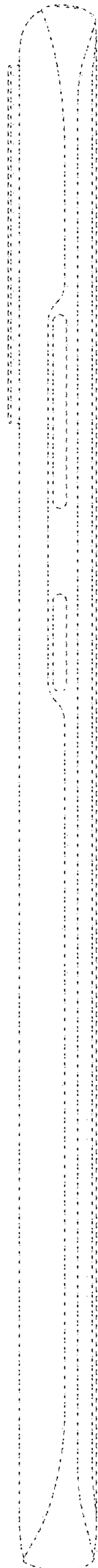

FIG. 5

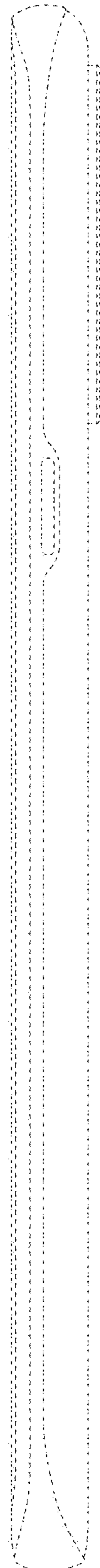

FIG. 6

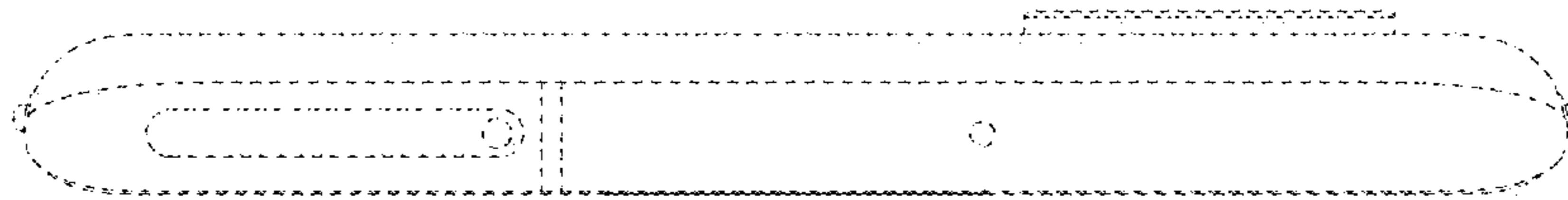

FIG. 7

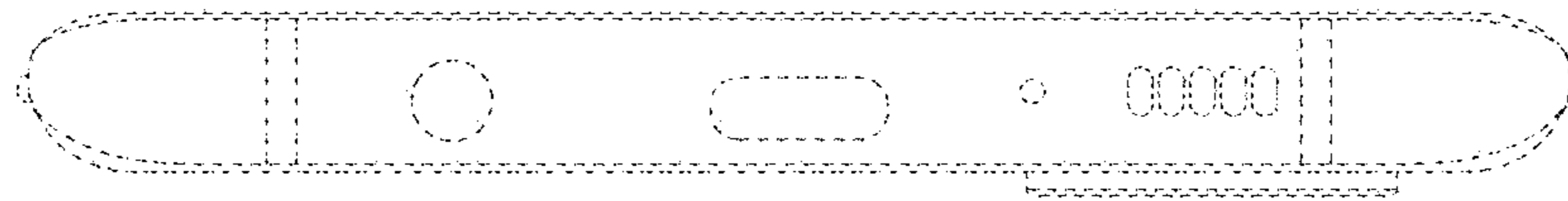

FIG. 8

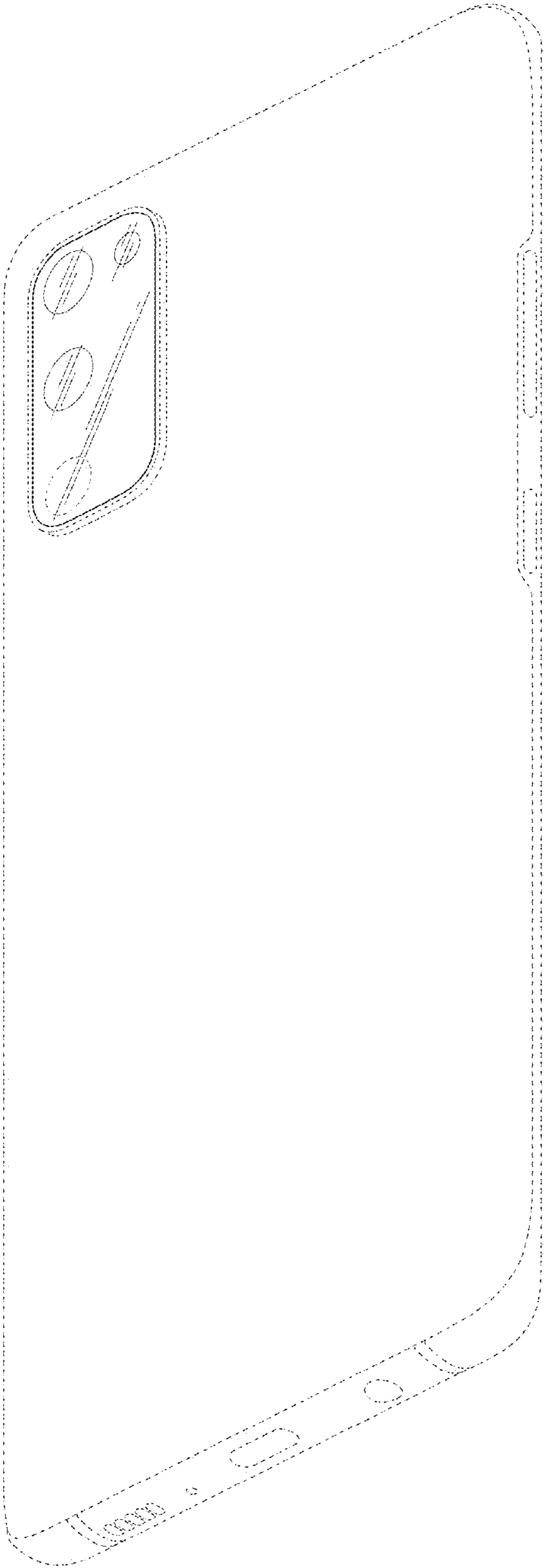

FIG. 9

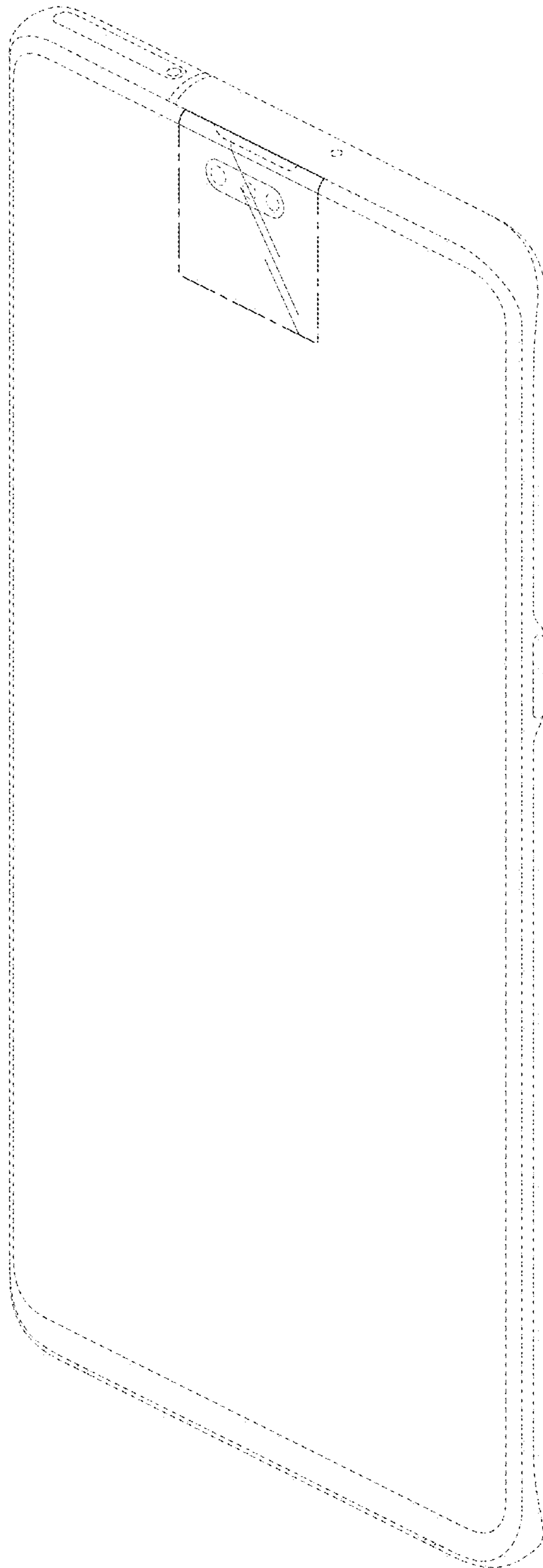

FIG. 10

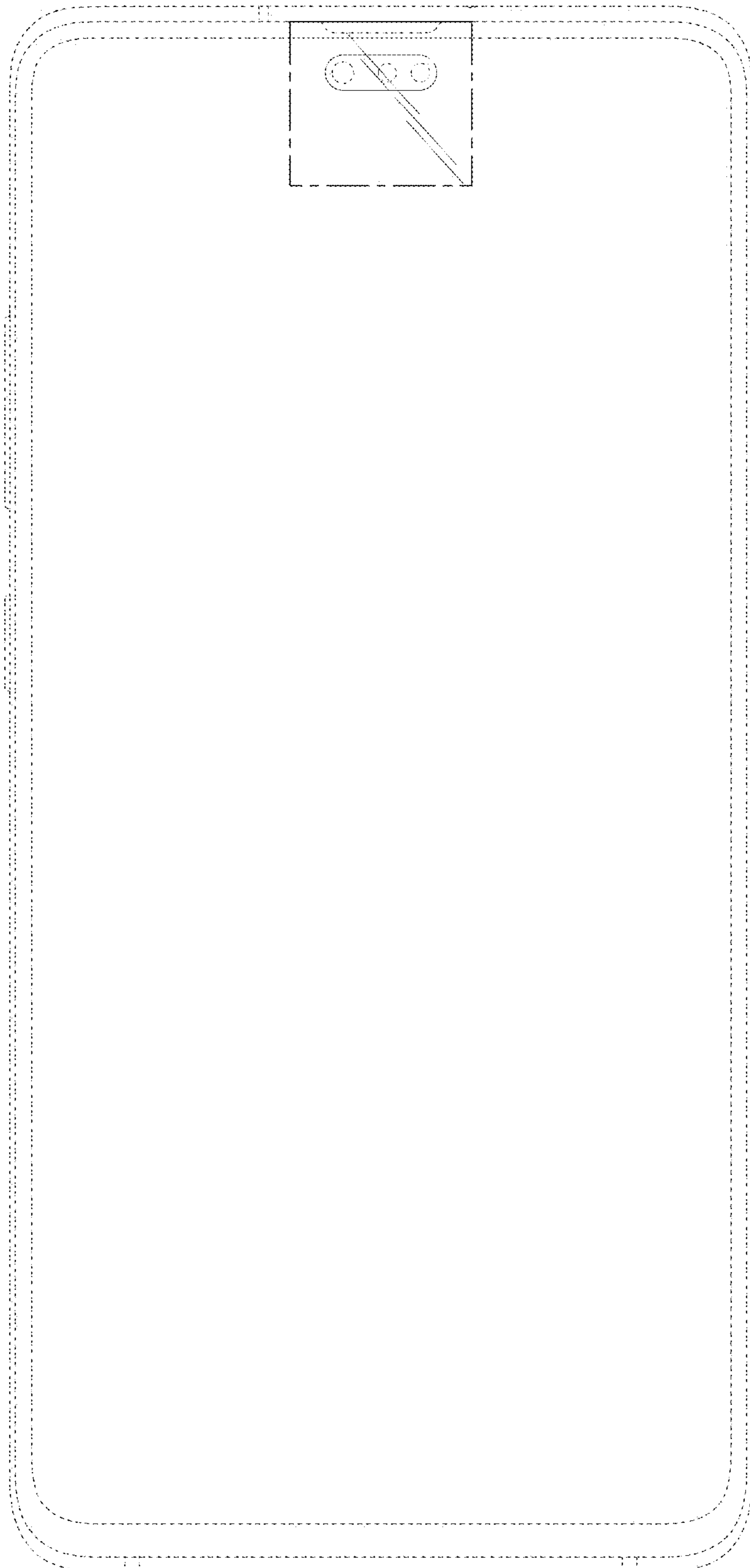

FIG. 11

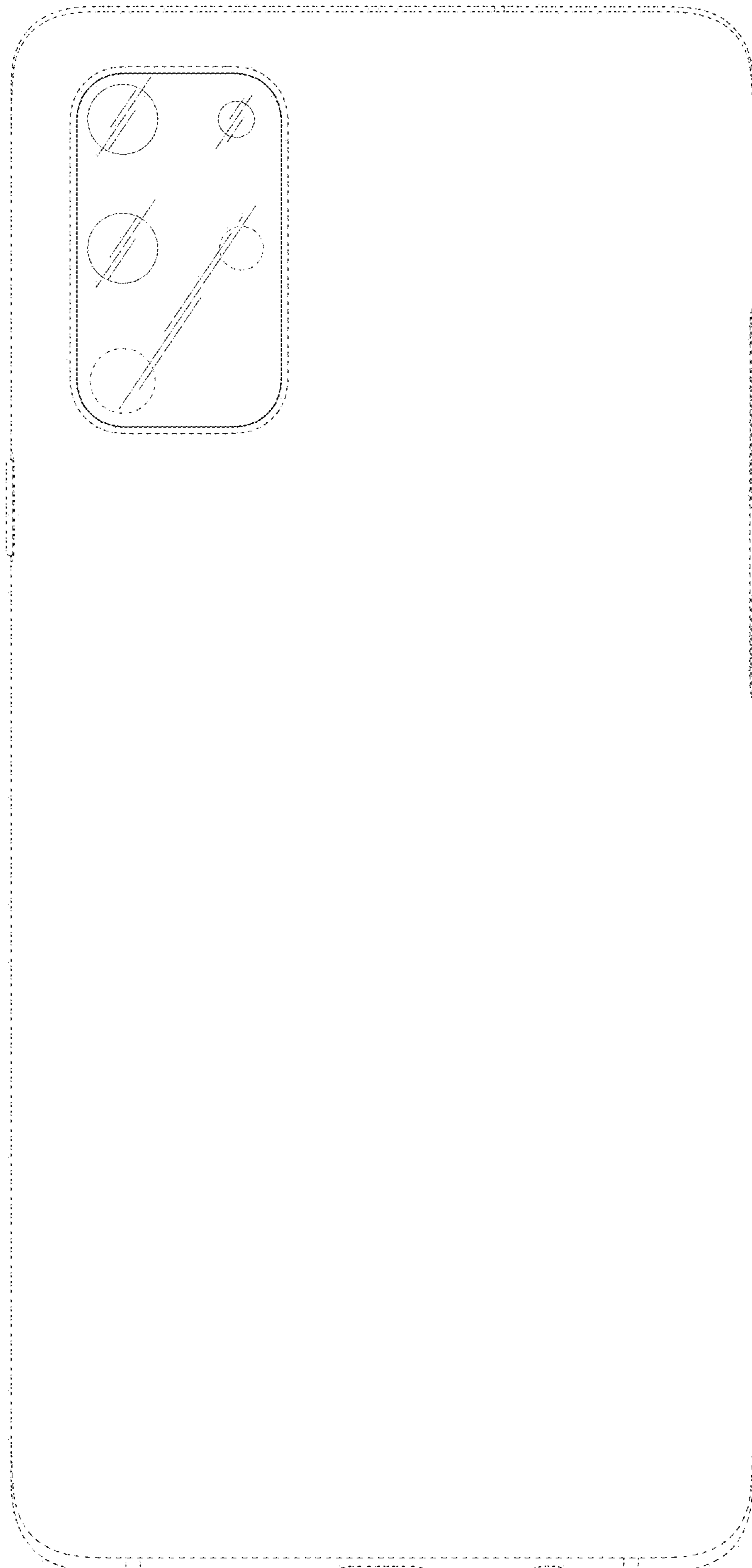

FIG. 12

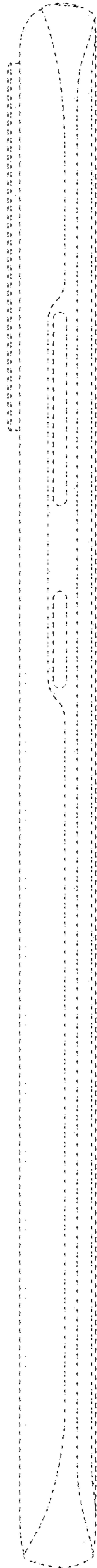

FIG. 13

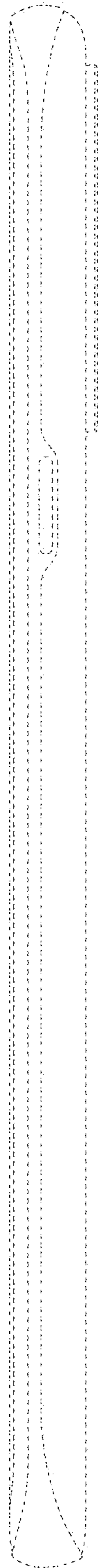

FIG. 14

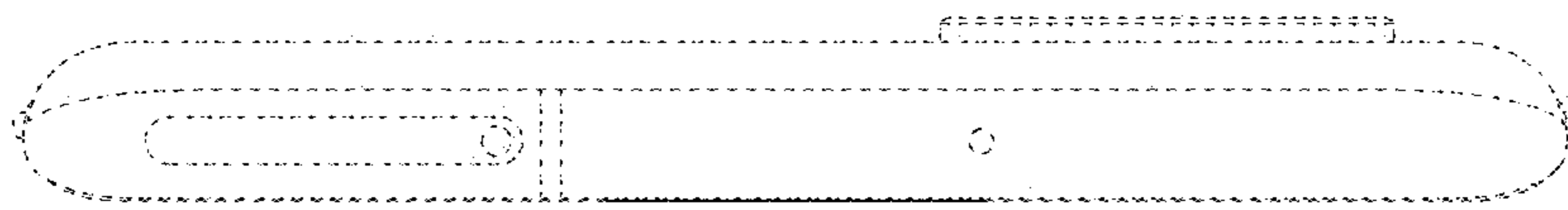

FIG. 15

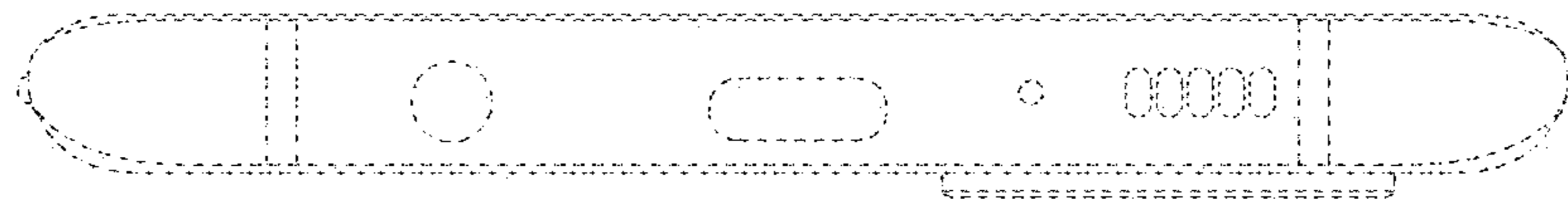

FIG. 16

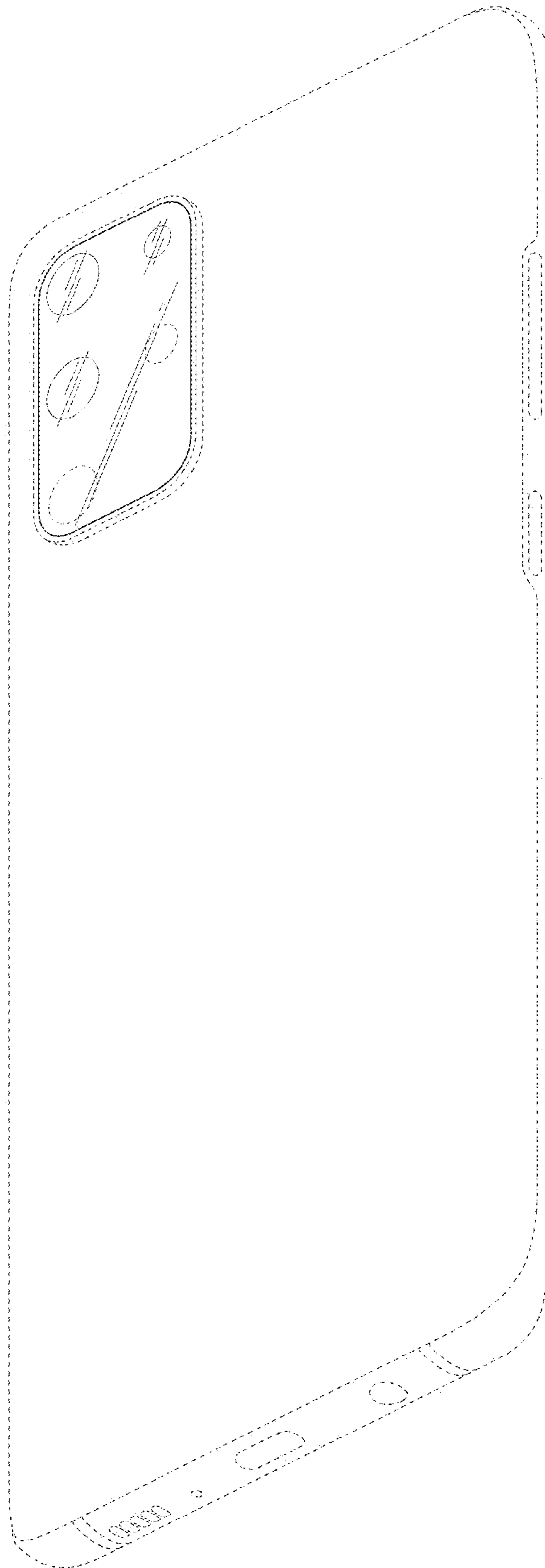

FIG. 17

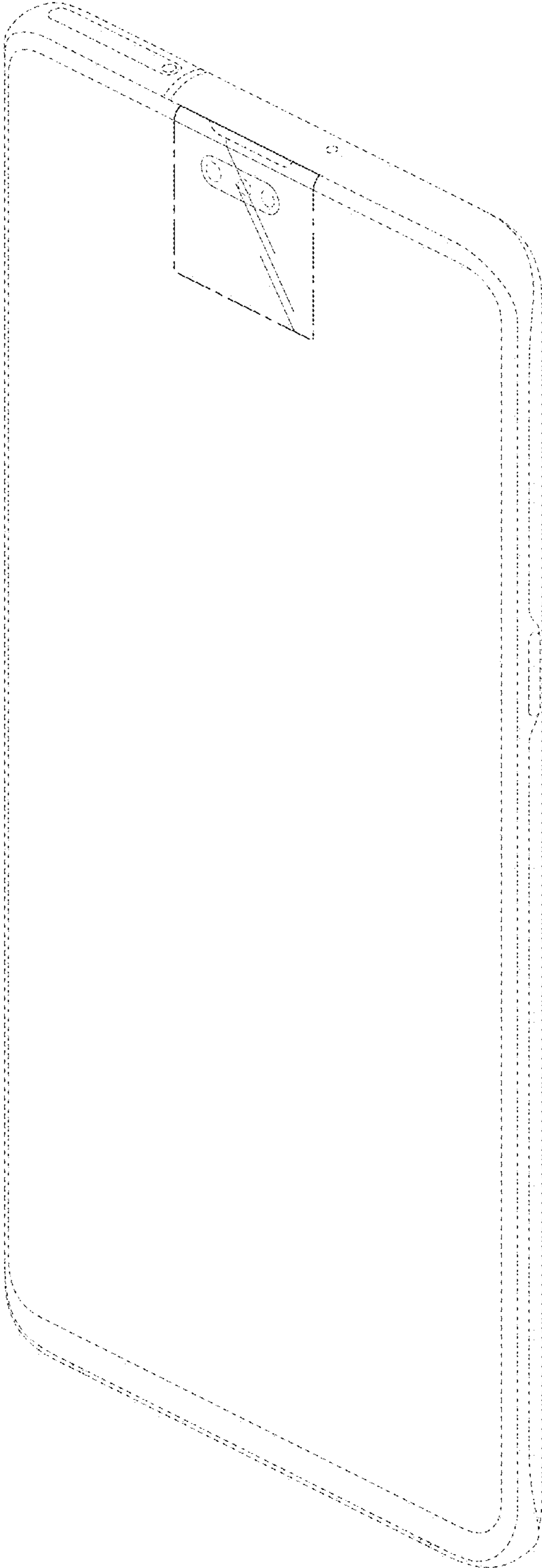

FIG. 18

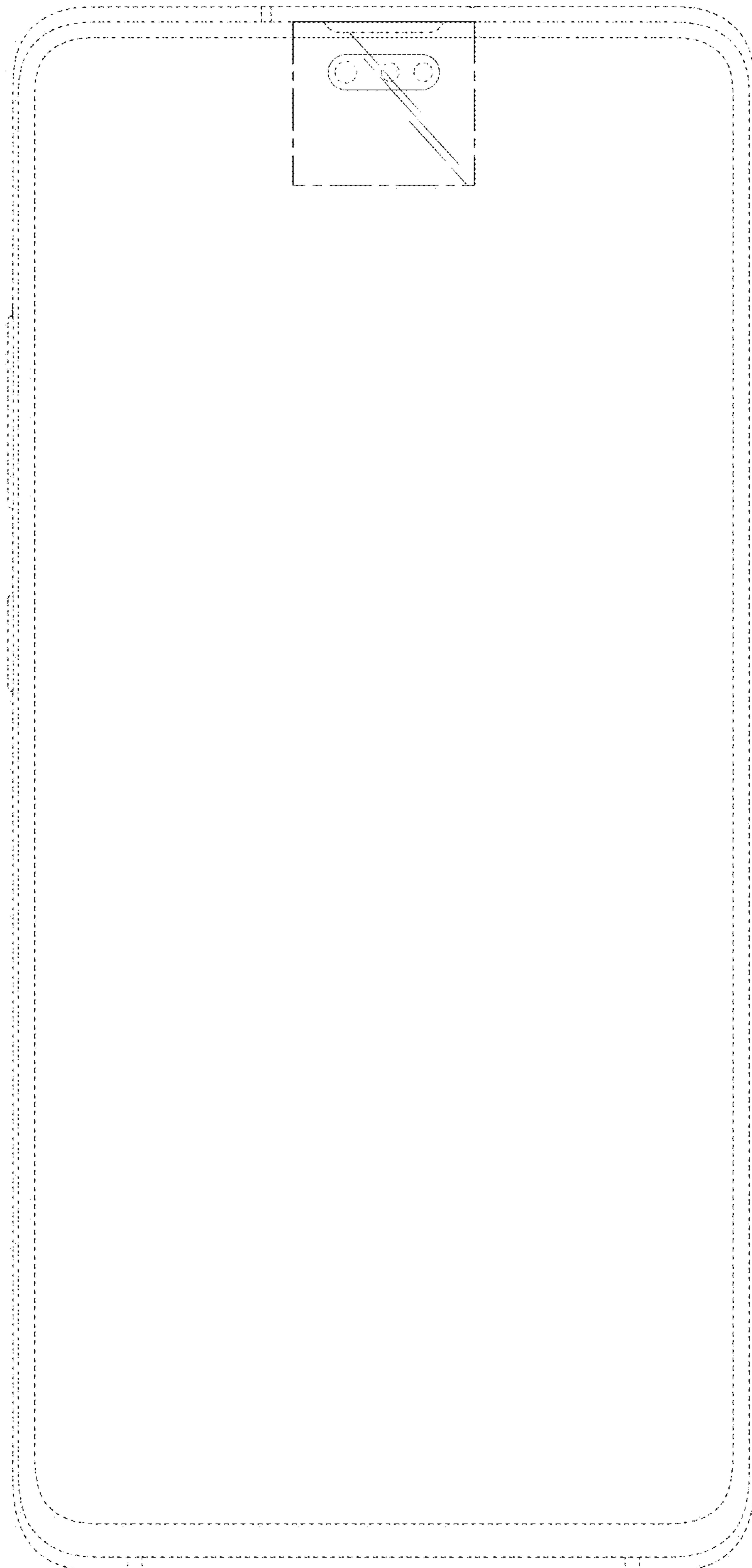

FIG. 19

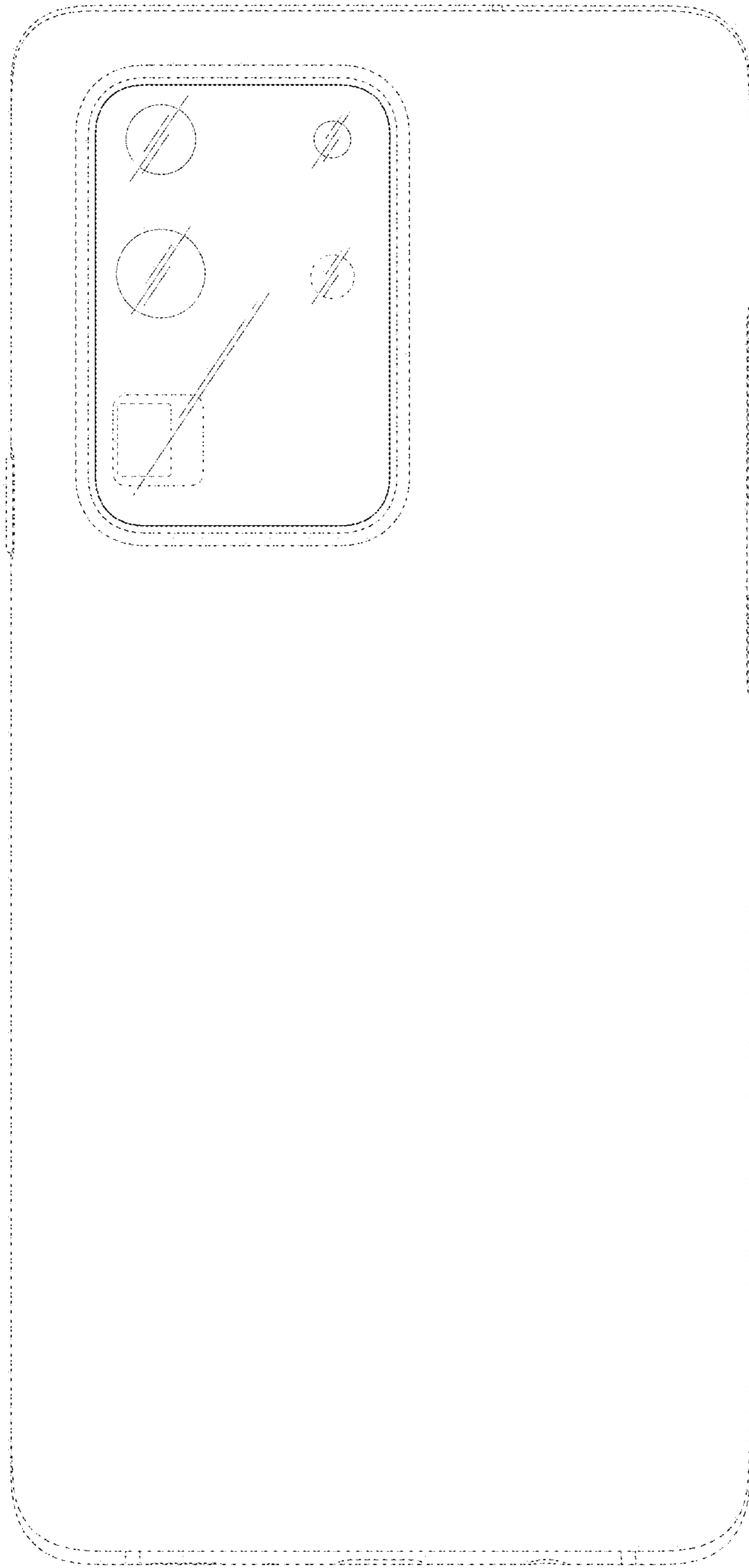

FIG. 20

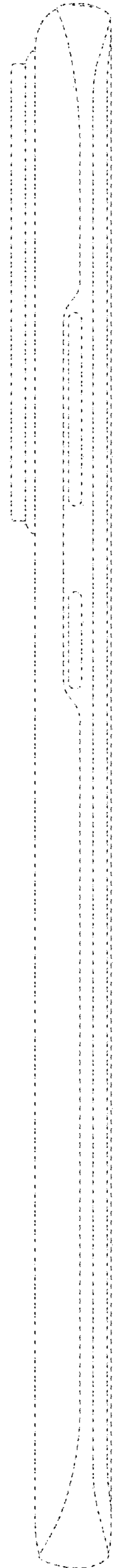

FIG. 21

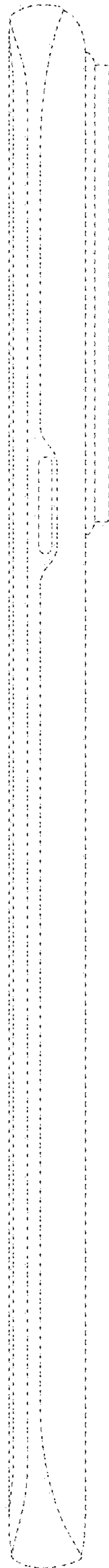

FIG. 22

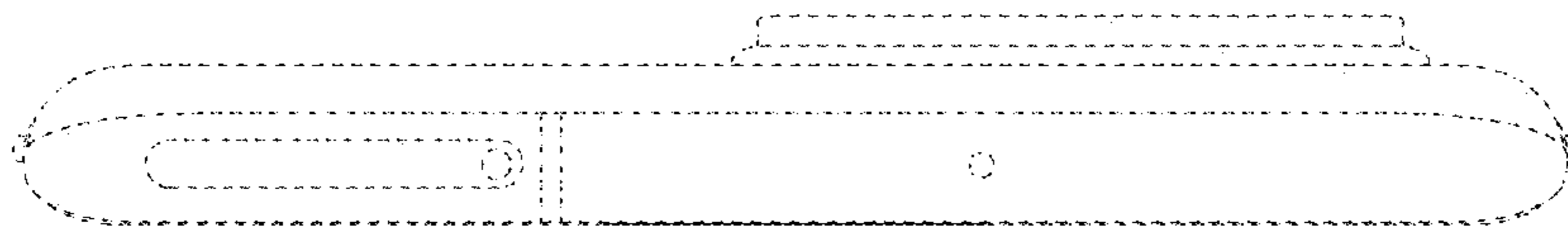

FIG. 23

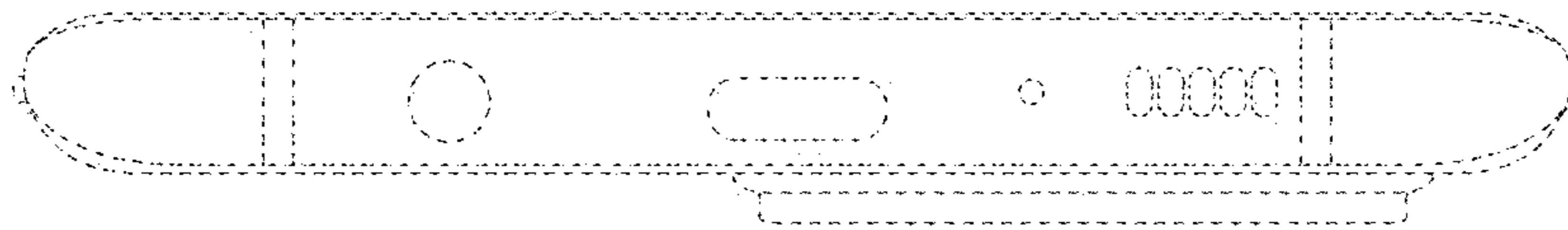

FIG. 24

