



US00D939425S

(12) **United States Design Patent**
Reed, Sr.

(10) **Patent No.:** **US D939,425 S**

(45) **Date of Patent:** **** Dec. 28, 2021**

(54) **SIDE PANEL STORAGE UNIT**

(71) Applicant: **Dorian Reed, Sr.**, Las Vegas, NV (US)

(72) Inventor: **Dorian Reed, Sr.**, Las Vegas, NV (US)

(**) Term: **15 Years**

(21) Appl. No.: **29/652,313**

(22) Filed: **Jul. 17, 2020**

(51) **LOC (13) Cl.** **12-16**

(52) **U.S. Cl.**
USPC **D12/423**

(58) **Field of Classification Search**
USPC D12/423, 424, 421, 192, 400, 190
CPC B65D 85/68; B60R 7/00
See application file for complete search history.

(56) **References Cited**

U.S. PATENT DOCUMENTS

D417,647 S	*	12/1999	Jardine	D12/423
D432,492 S	*	10/2000	Waskow	D12/423
D462,171 S	*	9/2002	Elabour	D12/423
D475,007 S	*	5/2003	McCoy	D12/423
D494,535 S	*	8/2004	McCoy	D12/423
D495,989 S	*	9/2004	Kohara	D12/424

D634,698 S	*	3/2011	Saint-Jalmes	D12/423
D687,079 S	*	7/2013	Mueller	D15/146
D746,213 S	*	12/2015	Castanha	D12/345
D830,949 S	*	10/2018	D'Halluin	D12/415
D882,489 S	*	4/2020	Ninov	D12/423
D890,079 S	*	7/2020	Chen	D12/423

* cited by examiner

Primary Examiner — Katrina A Betton
(74) *Attorney, Agent, or Firm* — Dunlap Bennett & Ludwig, PLLC; Anna L. Kinney

(57) **CLAIM**

The ornamental design for a side panel storage unit, as shown and described.

DESCRIPTION

FIG. 1 is a front perspective view of a side panel storage unit showing my new design;
FIG. 2 is a front elevation view thereof;
FIG. 3 is a rear elevation view thereof;
FIG. 4 is a left side view thereof;
FIG. 5 is a right side view thereof;
FIG. 6 is a top plan view thereof;
FIG. 7 is a bottom plan view thereof; and,
FIG. 8 is a front perspective view thereof, showing the invention in use.
The broken lines shown in the drawings depict environmental structure that forms no part of the claimed invention.

1 Claim, 6 Drawing Sheets

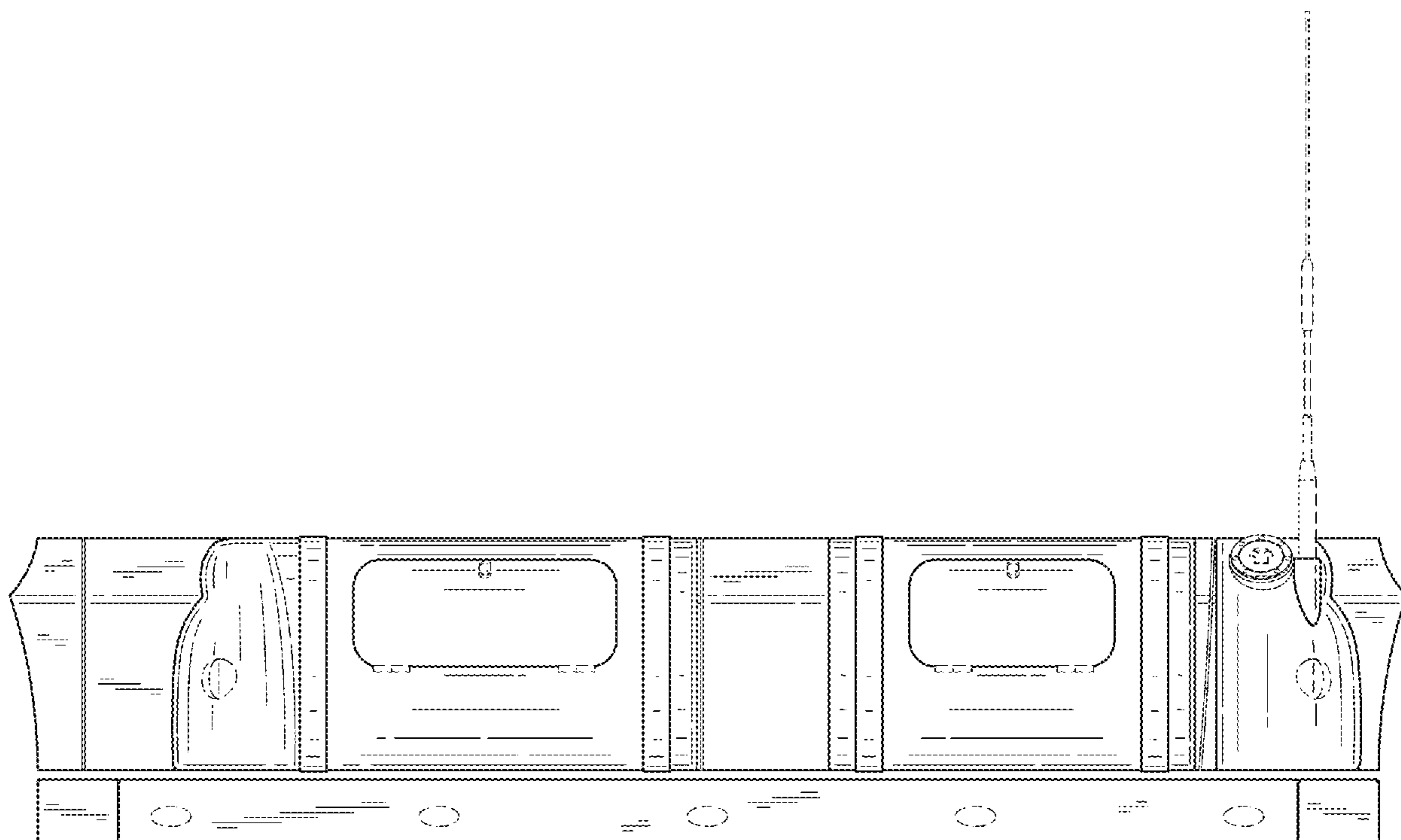

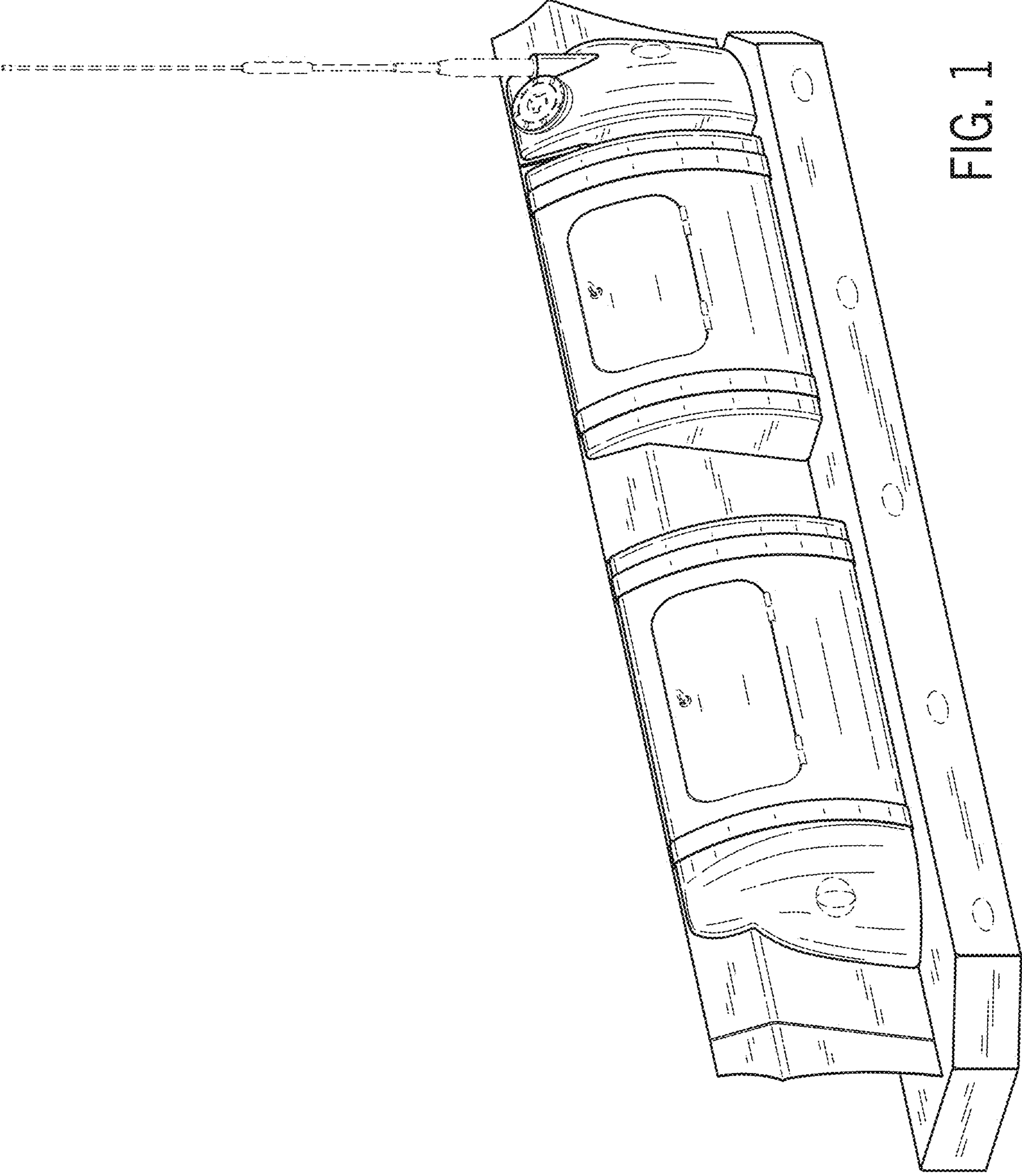

FIG. 1

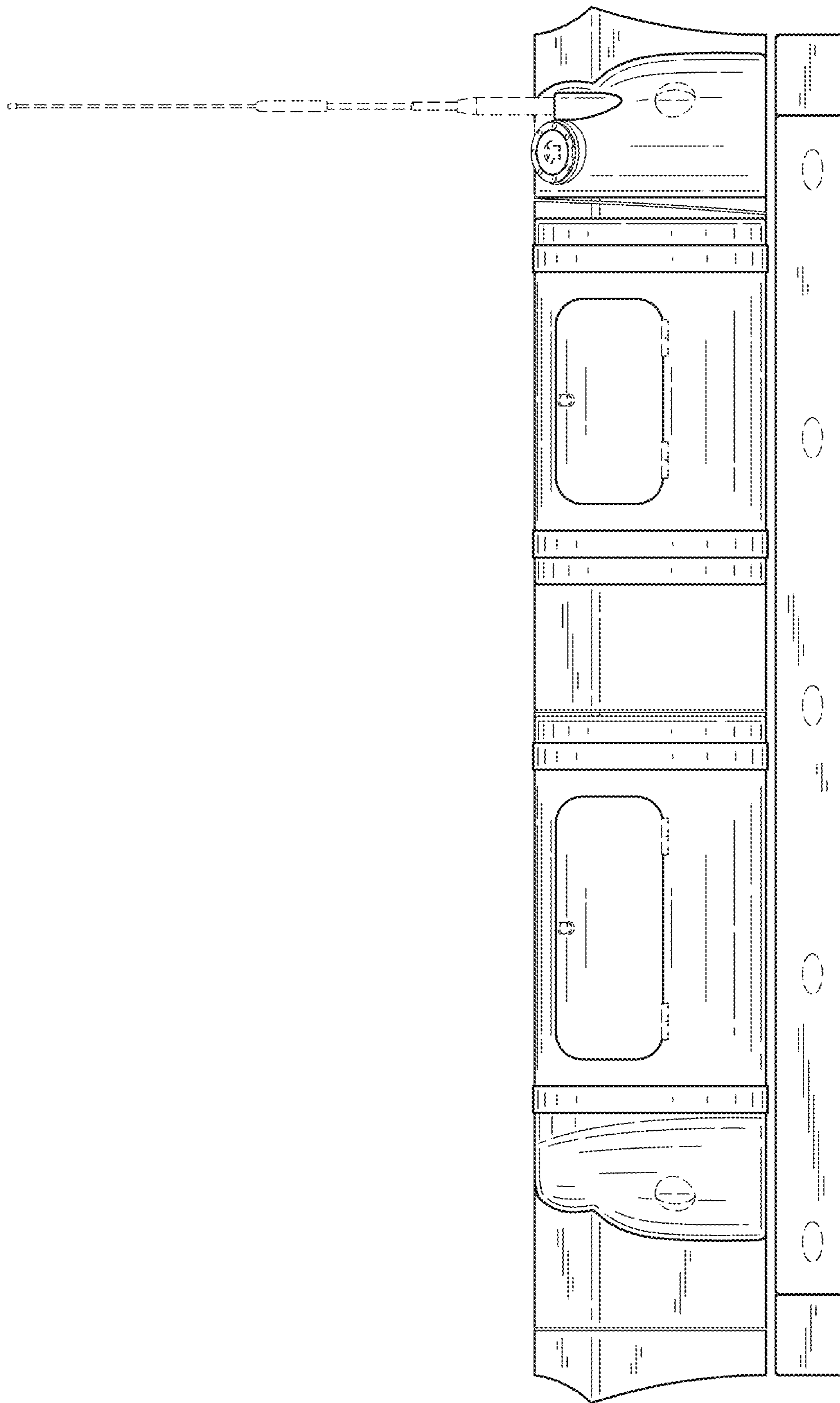

FIG. 2

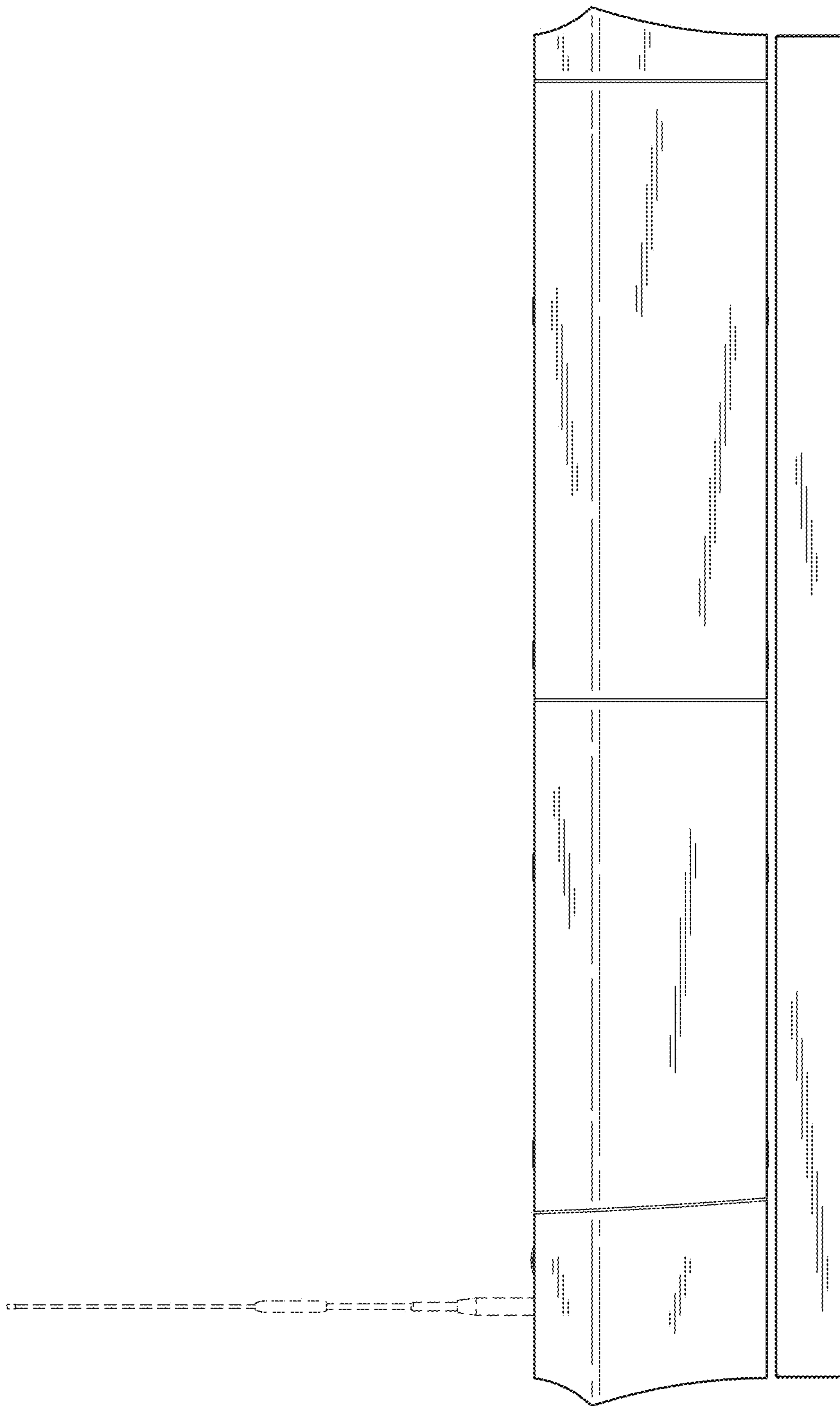

FIG. 3

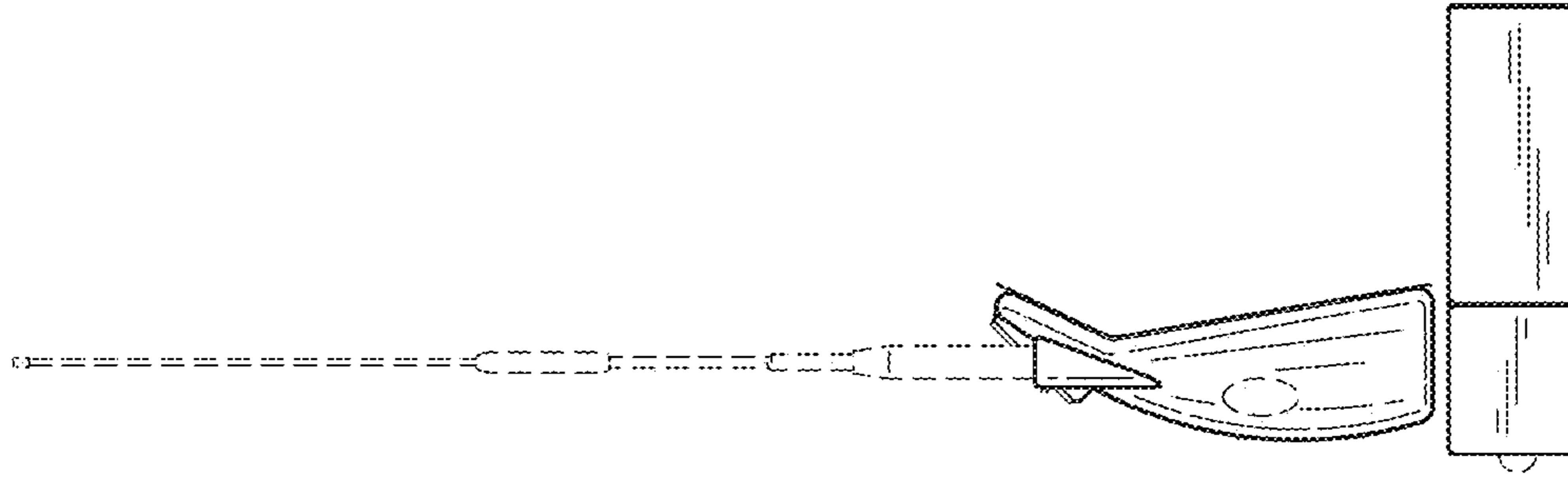

FIG. 5

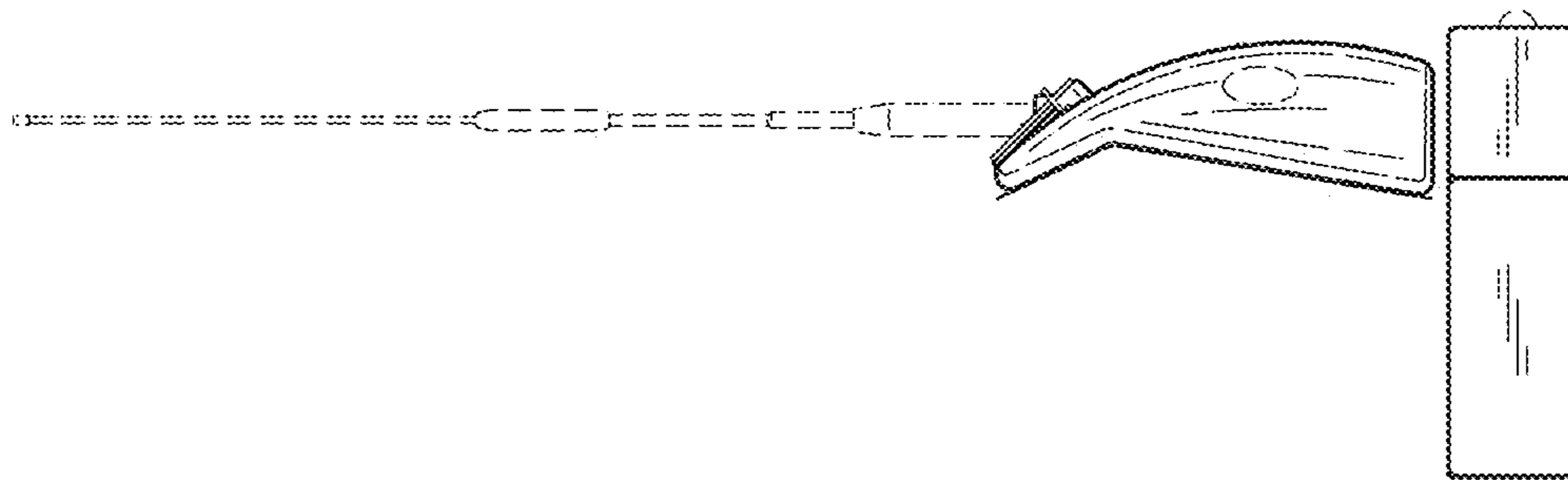

FIG. 4

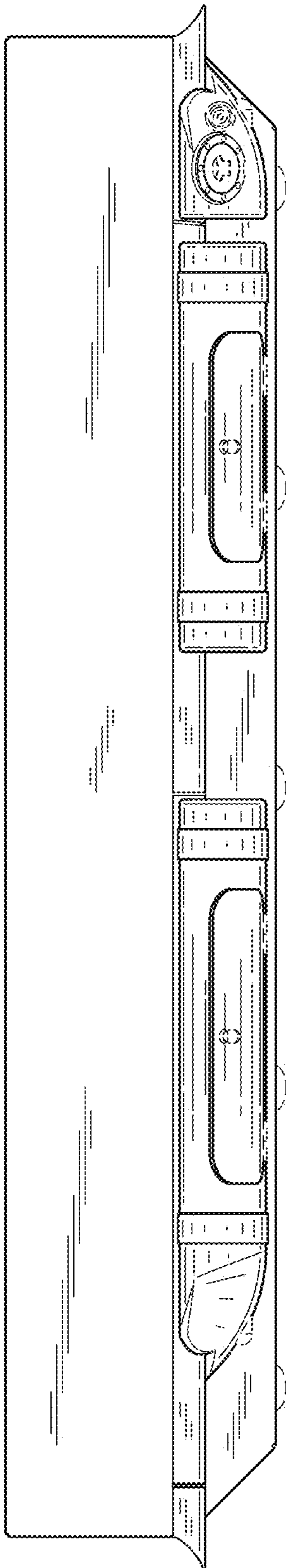

FIG. 6

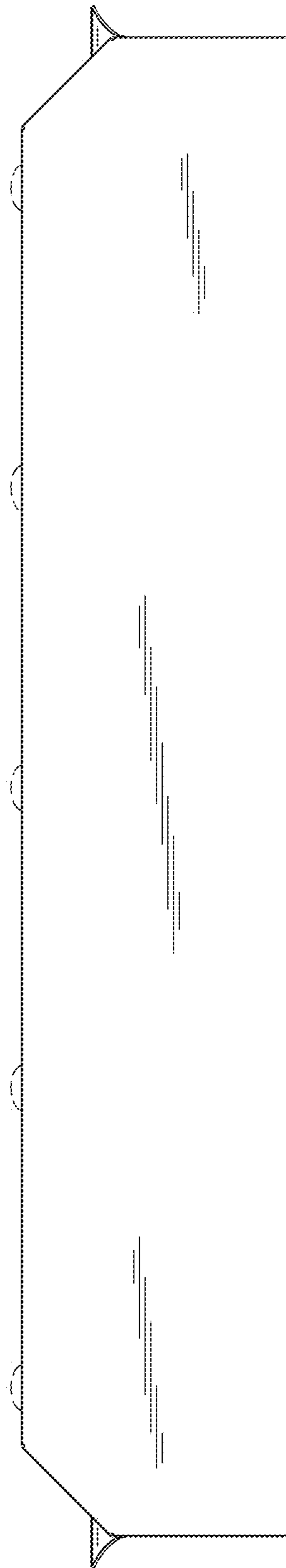

FIG. 7

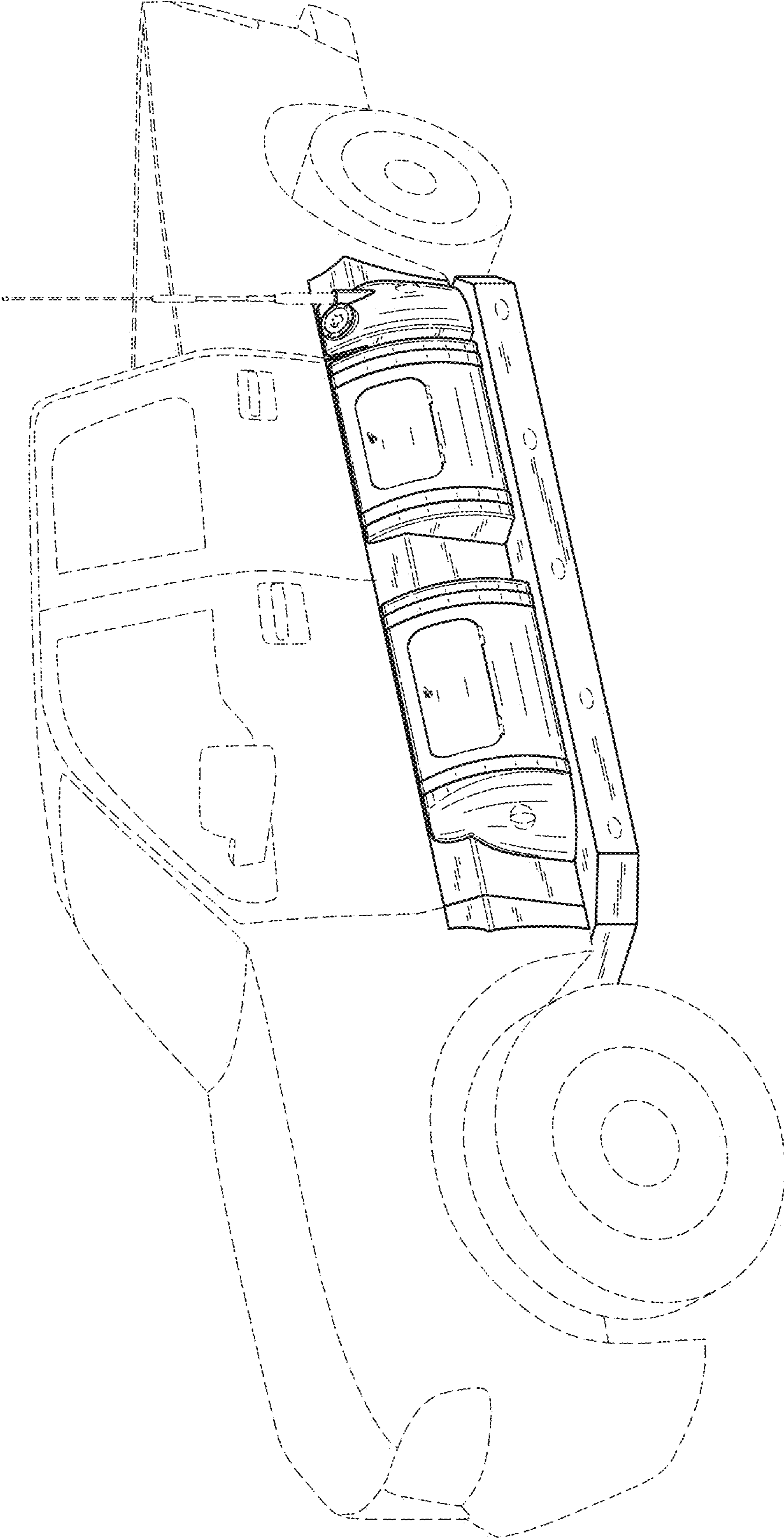

FIG. 8