



US00D939401S

(12) **United States Design Patent** (10) **Patent No.:** **US D939,401 S**
Becker (45) **Date of Patent:** **** Dec. 28, 2021**

(54) **VEHICLE REAR BUMPER**
(71) Applicant: **JAGUAR LAND ROVER LIMITED,**
Coventry (GB)
(72) Inventor: **Jannik Becker,** Coventry (GB)
(73) Assignee: **JAGUAR LAND ROVER LIMITED,**
Coventry (GB)
(**) Term: **15 Years**
(21) Appl. No.: **29/743,677**
(22) Filed: **Jul. 23, 2020**

(30) **Foreign Application Priority Data**
Jan. 24, 2020 (EM) 007552955-0006
(51) **LOC (13) Cl.** **12-16**
(52) **U.S. Cl.**
USPC **D12/169**
(58) **Field of Classification Search**
USPC D12/169, 163, 196, 86, 90-92;
296/180.1, 180.2; 293/102, 113, 115,
293/117, 120
CPC B60R 19/52; B60R 2019/25; B62D 25/084
See application file for complete search history.

(56) **References Cited**
U.S. PATENT DOCUMENTS
D814,985 S * 4/2018 Peat D12/169
D820,739 S * 6/2018 Suga D12/169
D824,300 S * 7/2018 Badstuebner D12/169

D841,535 S * 2/2019 Buckingham D12/169
D841,536 S * 2/2019 Ojea D12/169
D843,277 S * 3/2019 Ojea D12/169
D845,850 S * 4/2019 Kang D12/169
D856,865 S * 8/2019 Hatton D12/169
D860,074 S * 9/2019 Beckles D12/169
D861,550 S * 10/2019 Li D12/169
D864,055 S * 10/2019 Chan D12/169
D875,625 S * 2/2020 Wheel D12/169
D887,325 S * 6/2020 Kezha D12/169
D904,249 S * 12/2020 Bischoff D12/169
D904,250 S * 12/2020 Wheel D12/169
D909,930 S * 2/2021 Patel D12/169
D913,875 S * 3/2021 Bischoff D12/169
D913,876 S * 3/2021 Bischoff D12/169

* cited by examiner

Primary Examiner — Melody N Brown
(74) *Attorney, Agent, or Firm* — Reising Ethington P.C.

(57) **CLAIM**
The ornamental design for a vehicle rear bumper, as shown
and described.

DESCRIPTION
FIG. 1 is a front and left side perspective view of a vehicle
rear bumper showing my new design;
FIG. 2 is a front view thereof;
FIG. 3 is a right side view thereof;
FIG. 4 is a left side view thereof;
FIG. 5 is a top view thereof;
FIG. 6 is a bottom view thereof;
FIG. 7 is a rear and right side perspective view thereof; and,
FIG. 8 is a rear view thereof.

1 Claim, 8 Drawing Sheets

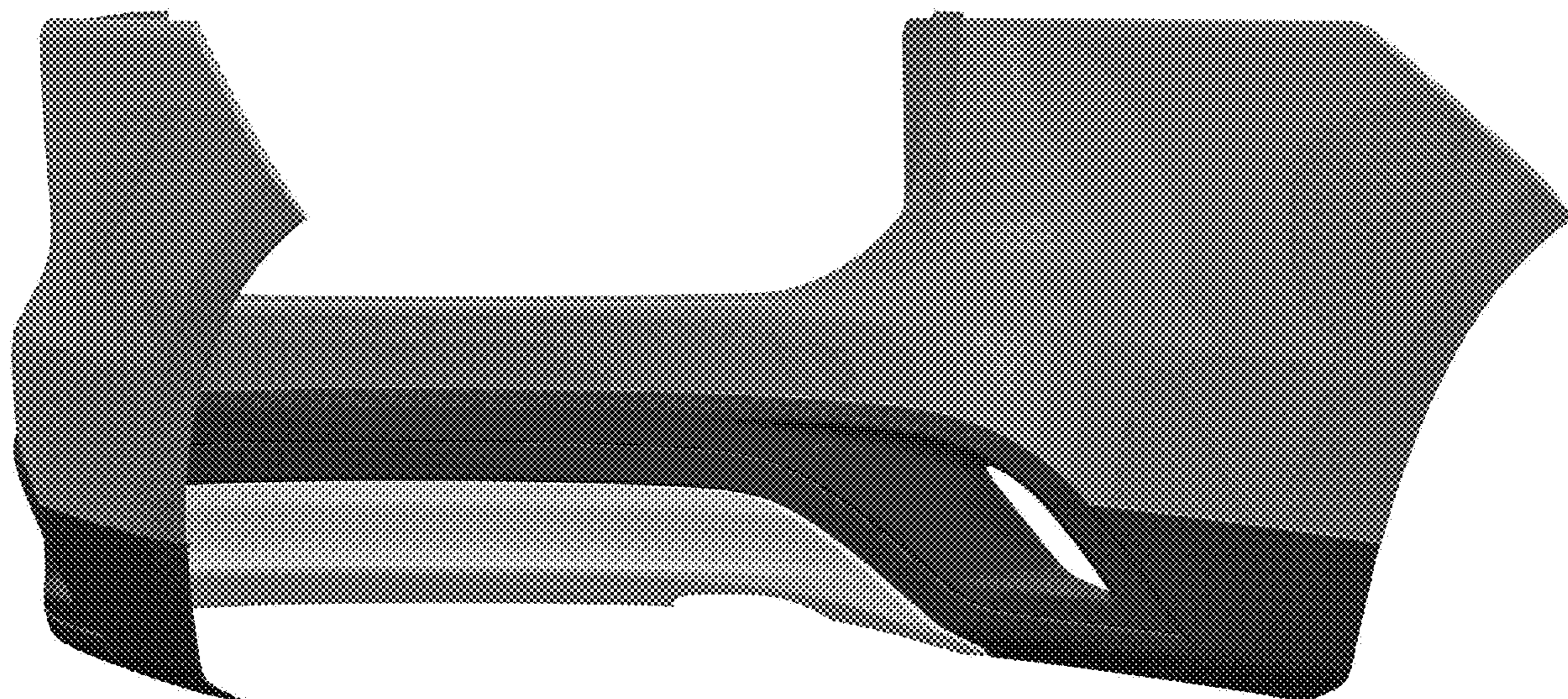

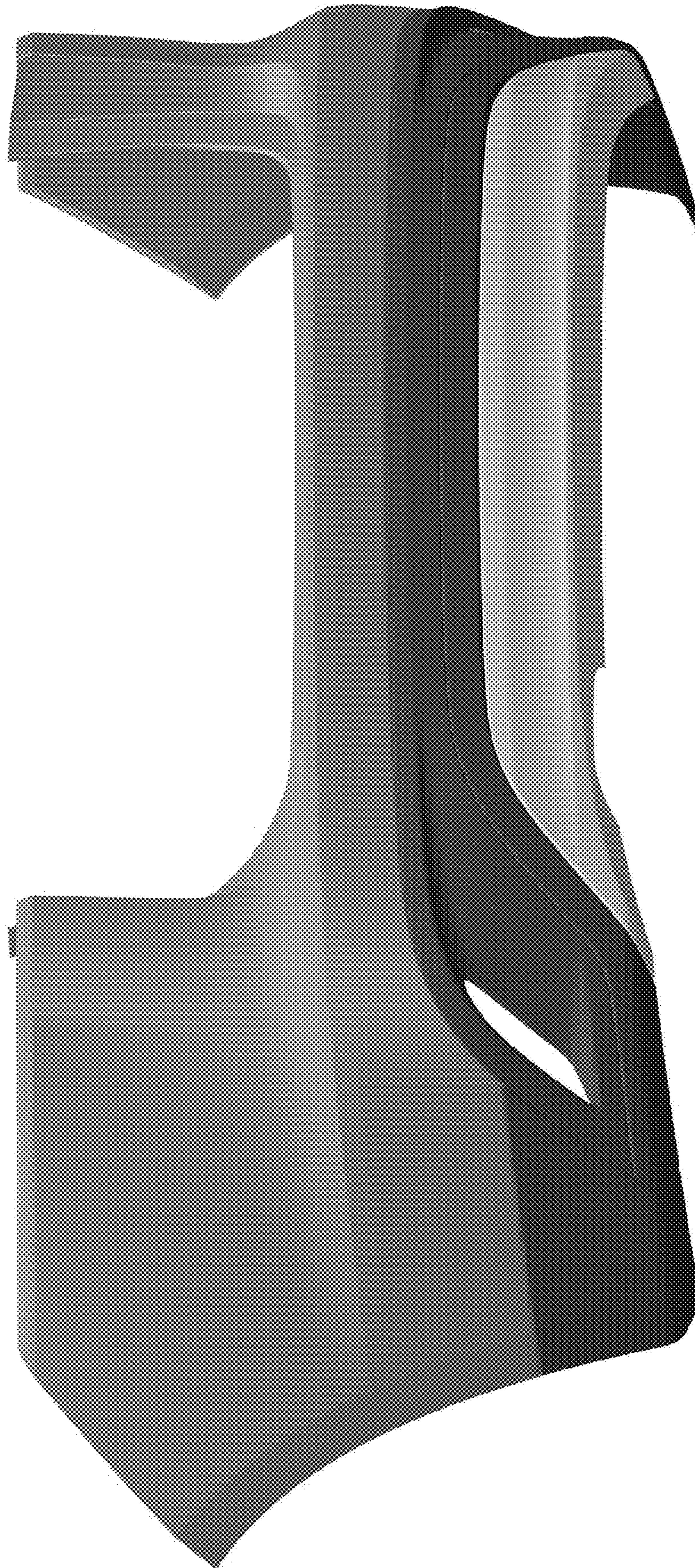

FIG. 1

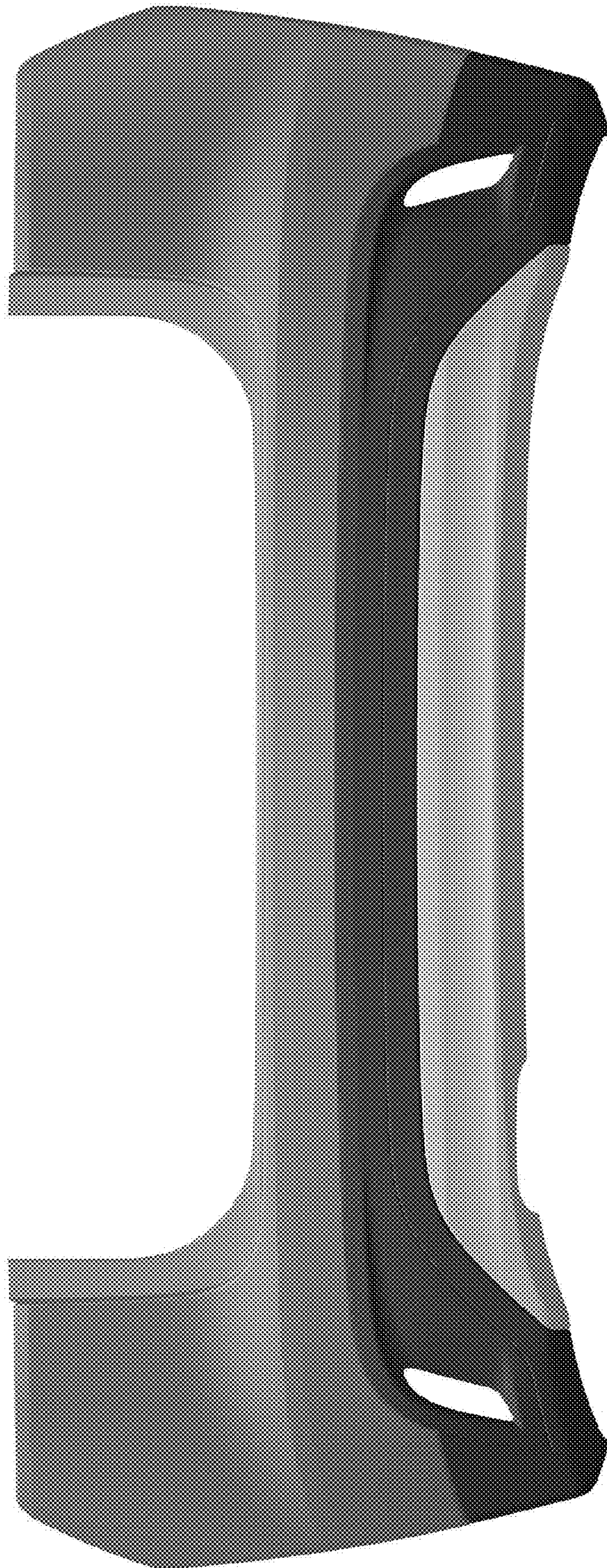

FIG. 2

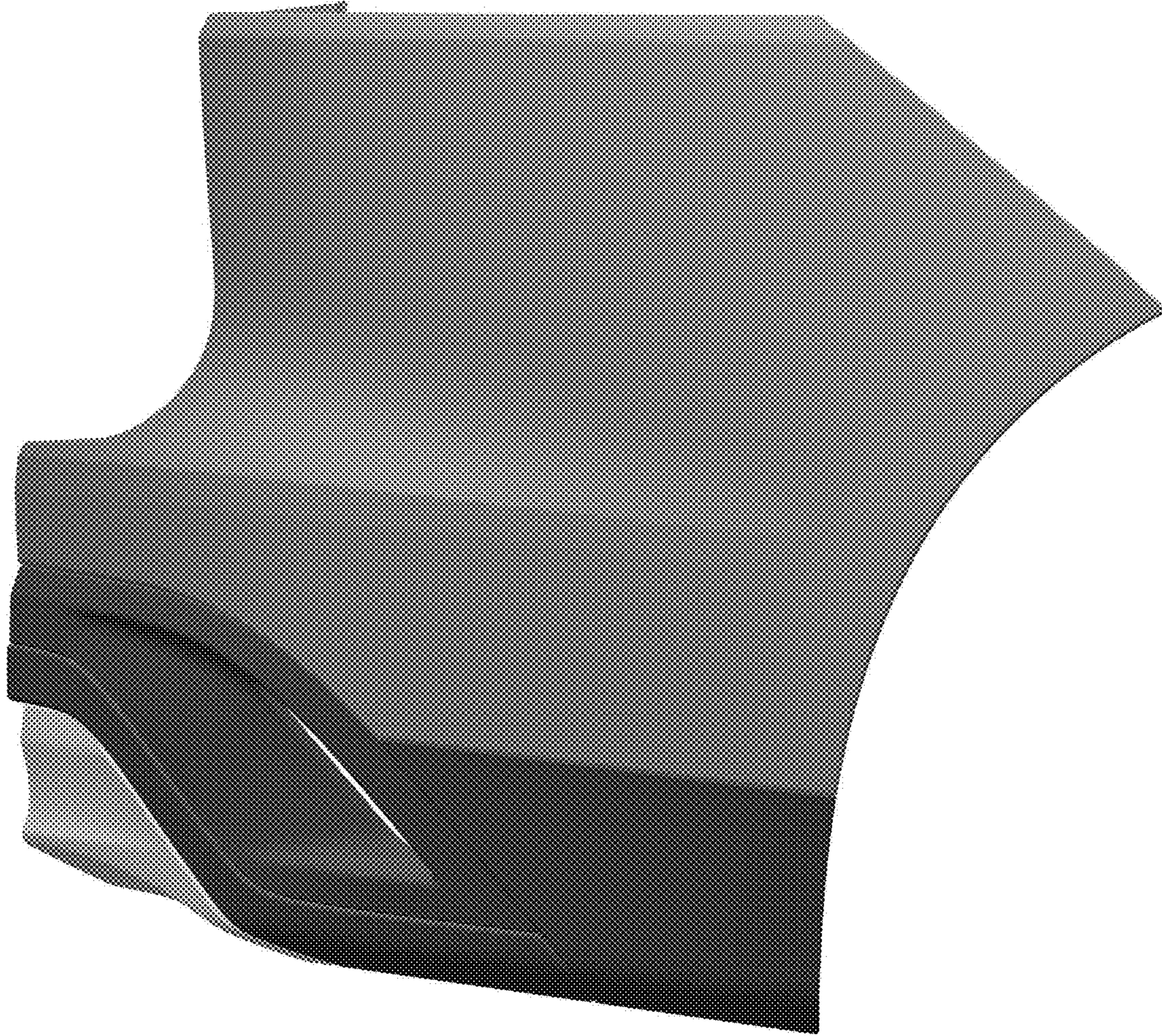

FIG. 3

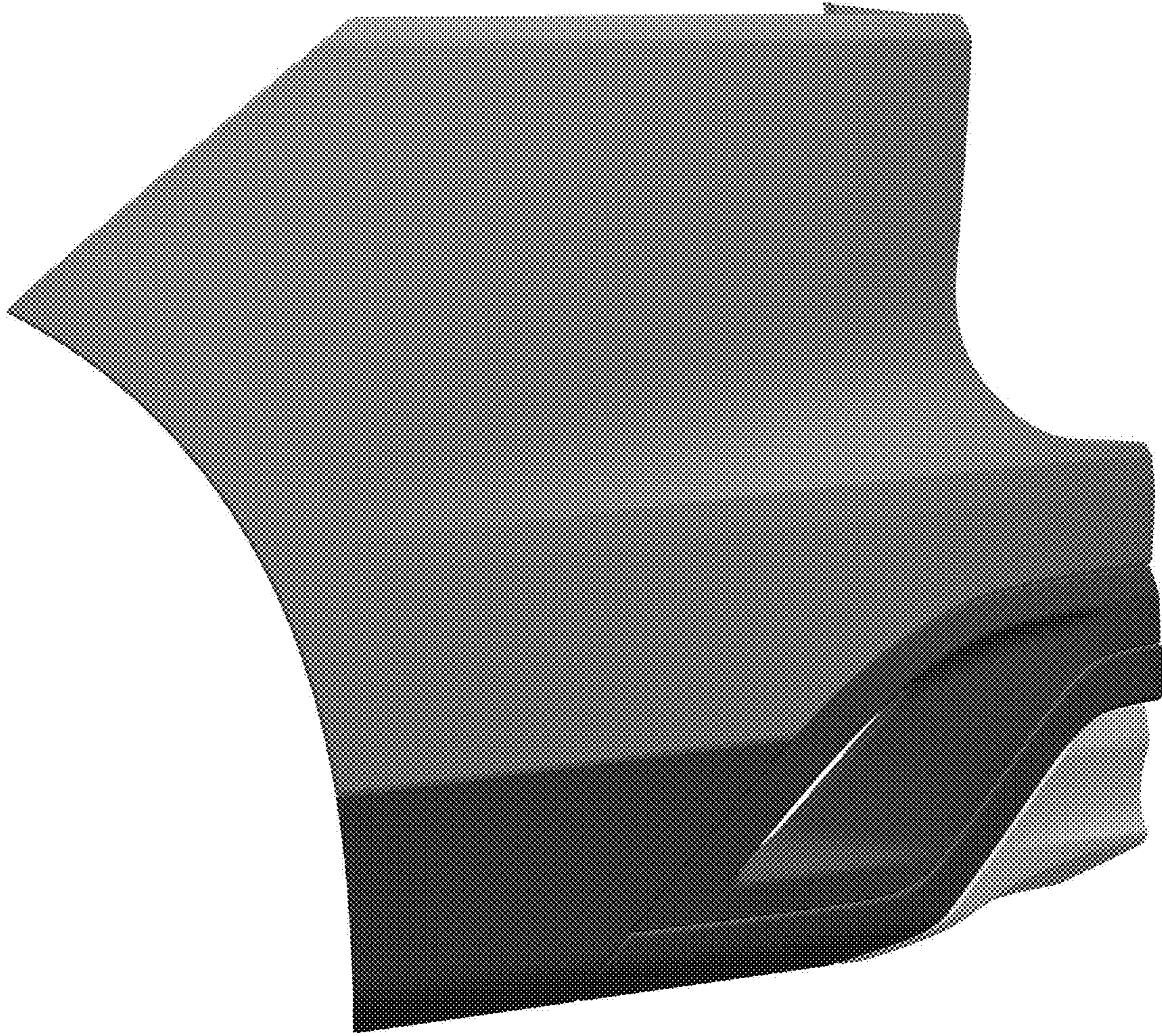

FIG. 4

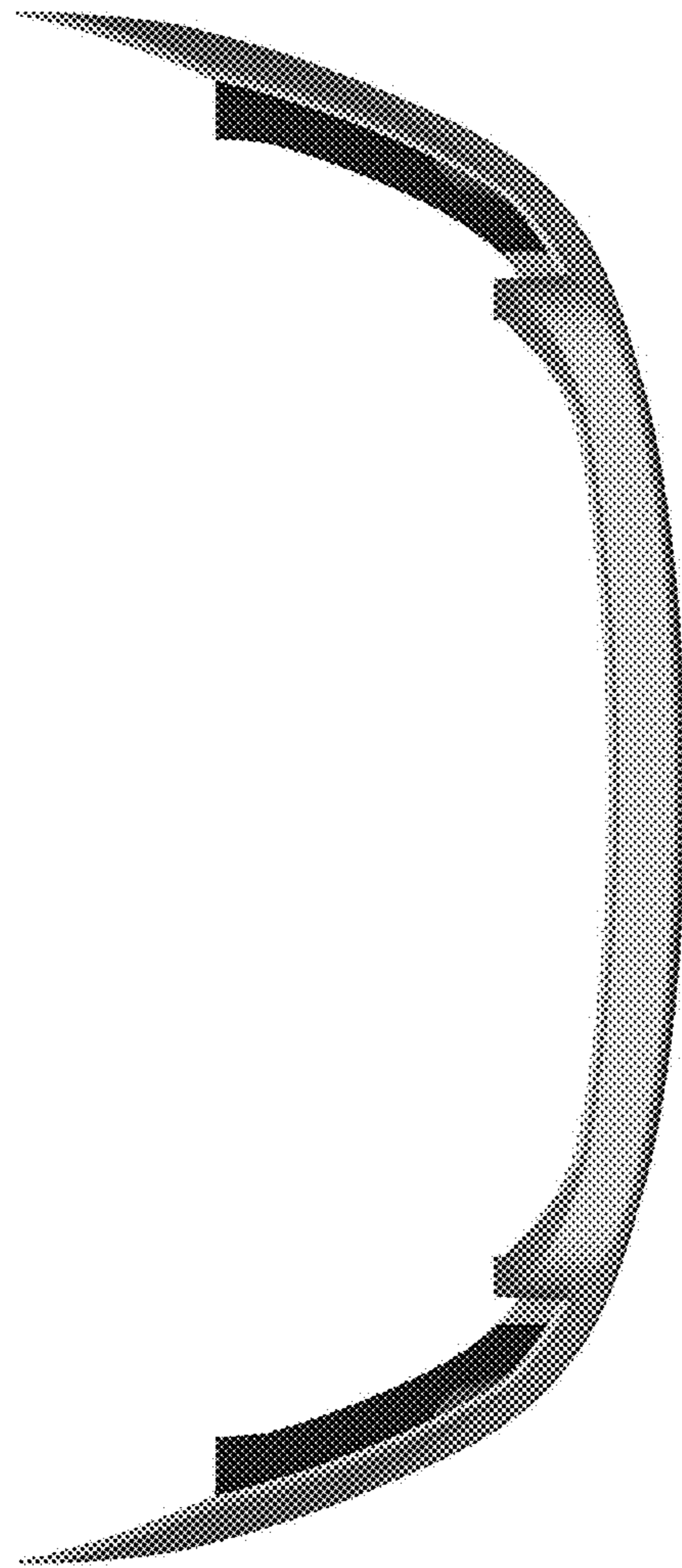

FIG. 5

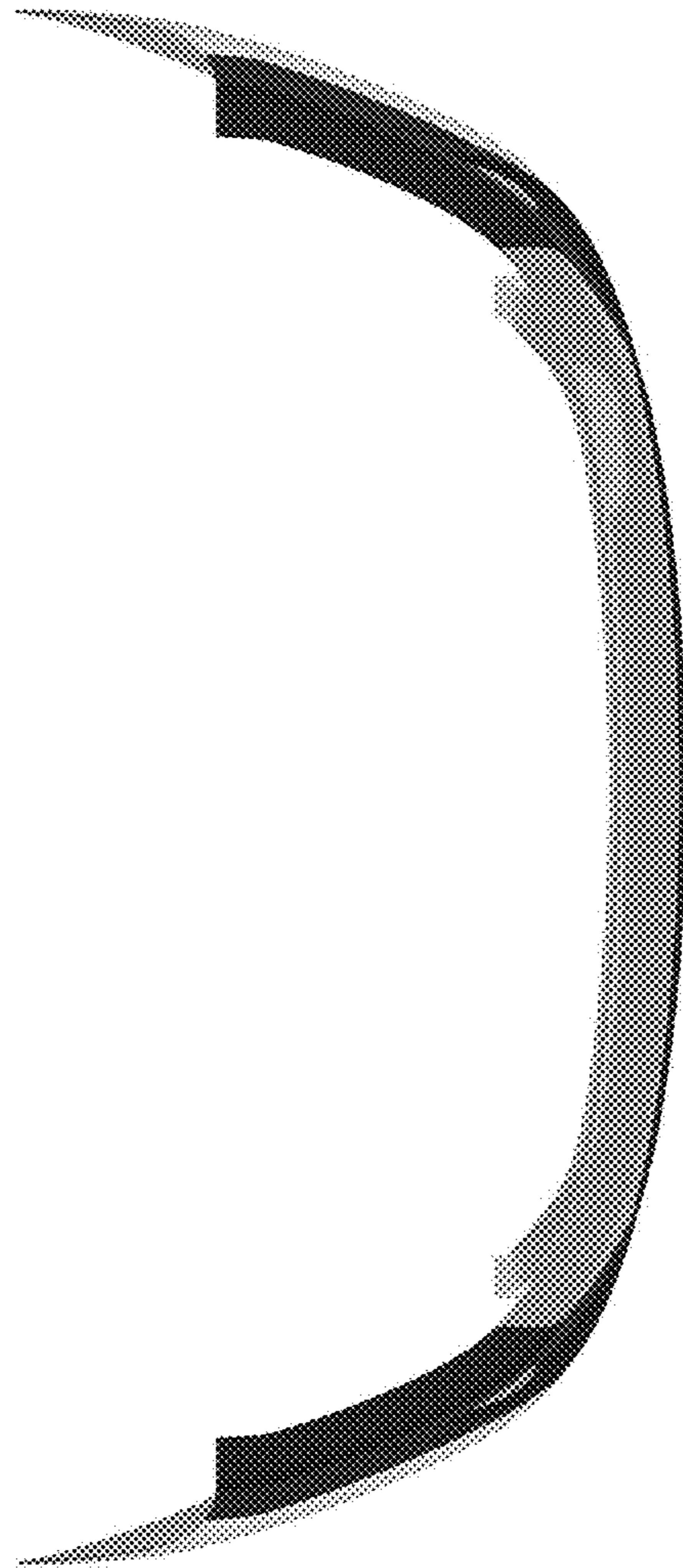

FIG. 6



FIG. 7

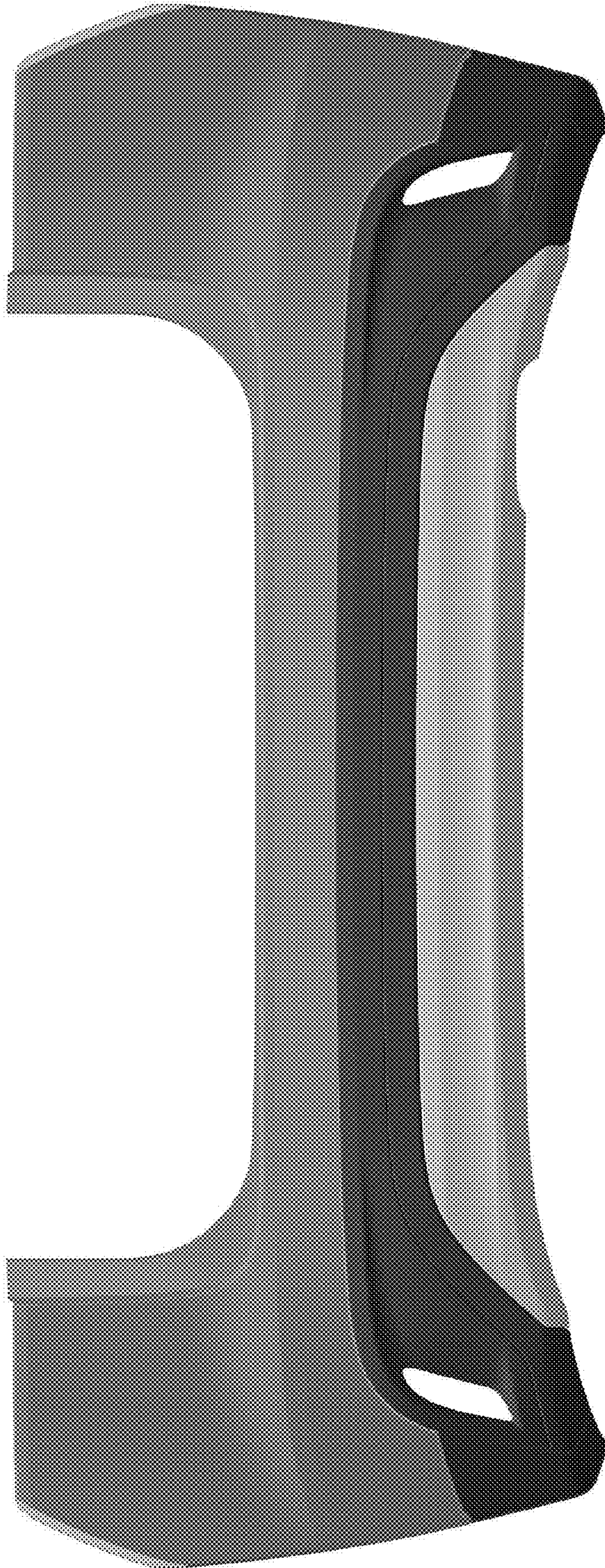

FIG. 8