



US00D939358S

(12) **United States Design Patent**  
**Hammi**

(10) **Patent No.:** **US D939,358 S**

(45) **Date of Patent:** **\*\* Dec. 28, 2021**

- (54) **FOOD OR DRINK CONTAINER**
- (71) Applicant: **ChooMee Inc.**, Rocklin, CA (US)
- (72) Inventor: **Julie A. Hammi**, Rocklin, CA (US)
- (73) Assignee: **ChooMee Inc.**, Rocklin, CA (US)
- (\*\*) Term: **15 Years**
- (21) Appl. No.: **29/733,391**
- (22) Filed: **May 1, 2020**
- (51) **LOC (13) Cl.** ..... **09-05**
- (52) **U.S. Cl.**  
USPC ..... **D9/709**
- (58) **Field of Classification Search**  
USPC ..... D9/702-714, 720-722, 414, 434-435,  
D9/696, 716, 771, 447, 516-517,  
D9/738-747, 544, 520-521, 442, 444,  
D9/525; D24/118, 207, 108; 383/6, 9,  
383/22, 96, 61.1, 80-81, 104, 901, 63,  
383/203, 107, 119-120, 123, 61.2, 44;  
220/675, 495.03; 215/381-385, 400, 328,  
215/316; 206/484; D3/202; 428/34.3;  
222/92, 215, 95, 107; 604/408, 403, 415  
CPC ... B65D 1/00; B65D 1/02; B65D 1/09; B65D  
1/10; B65D 1/32; B65D 1/0223; B65D  
33/00; B65D 33/06; B65D 33/065; B65D  
33/14; B65D 33/1683; B65D 33/12;  
B65D 31/10; B65D 47/00; B65D 47/06;  
B65D 35/00; B65D 35/38  
See application file for complete search history.

- D656,038 S \* 3/2012 Molayem ..... D9/708
- D687,318 S \* 8/2013 Panetta ..... D9/608
- D729,580 S 5/2015 Waldis et al.
- D732,974 S \* 6/2015 Anastasiadis ..... D9/709
- D772,076 S \* 11/2016 Waldis ..... D9/710
- D922,881 S \* 6/2021 Haskins ..... D9/708

\* cited by examiner

*Primary Examiner* — Abraham Bahta

(74) *Attorney, Agent, or Firm* — Banner & Witcoff, Ltd.

(57) **CLAIM**

The ornamental design for a food or drink container, as shown and described.

**DESCRIPTION**

FIG. 1 is a front perspective view of a food or drink container showing my new design in a closed state;  
 FIG. 2 is a front view thereof;  
 FIG. 3 is a rear view thereof;  
 FIG. 4 is a right side view thereof;  
 FIG. 5 is a left side view thereof;  
 FIG. 6 is a top view thereof;  
 FIG. 7 is a bottom view thereof;  
 FIG. 8 is a front perspective view of the food or drink container of FIGS. 1-7 shown in an opened state;  
 FIG. 9 is a front view thereof;  
 FIG. 10 is a rear view thereof;  
 FIG. 11 is a right side view thereof;  
 FIG. 12 is a left side view thereof;  
 FIG. 13 is a top view thereof; and,  
 FIG. 14 is a bottom view thereof.

The broken lines immediately adjacent to the shaded area represent the bounds of the claimed design and form no part thereof. The broken lines depicting the remainder of the food or drink container represent features which form no part of the claimed design.

(56) **References Cited**

**U.S. PATENT DOCUMENTS**

- D396,630 S \* 8/1998 Lerner ..... D9/709
- D560,122 S \* 1/2008 Fuchs ..... D9/708

**1 Claim, 10 Drawing Sheets**

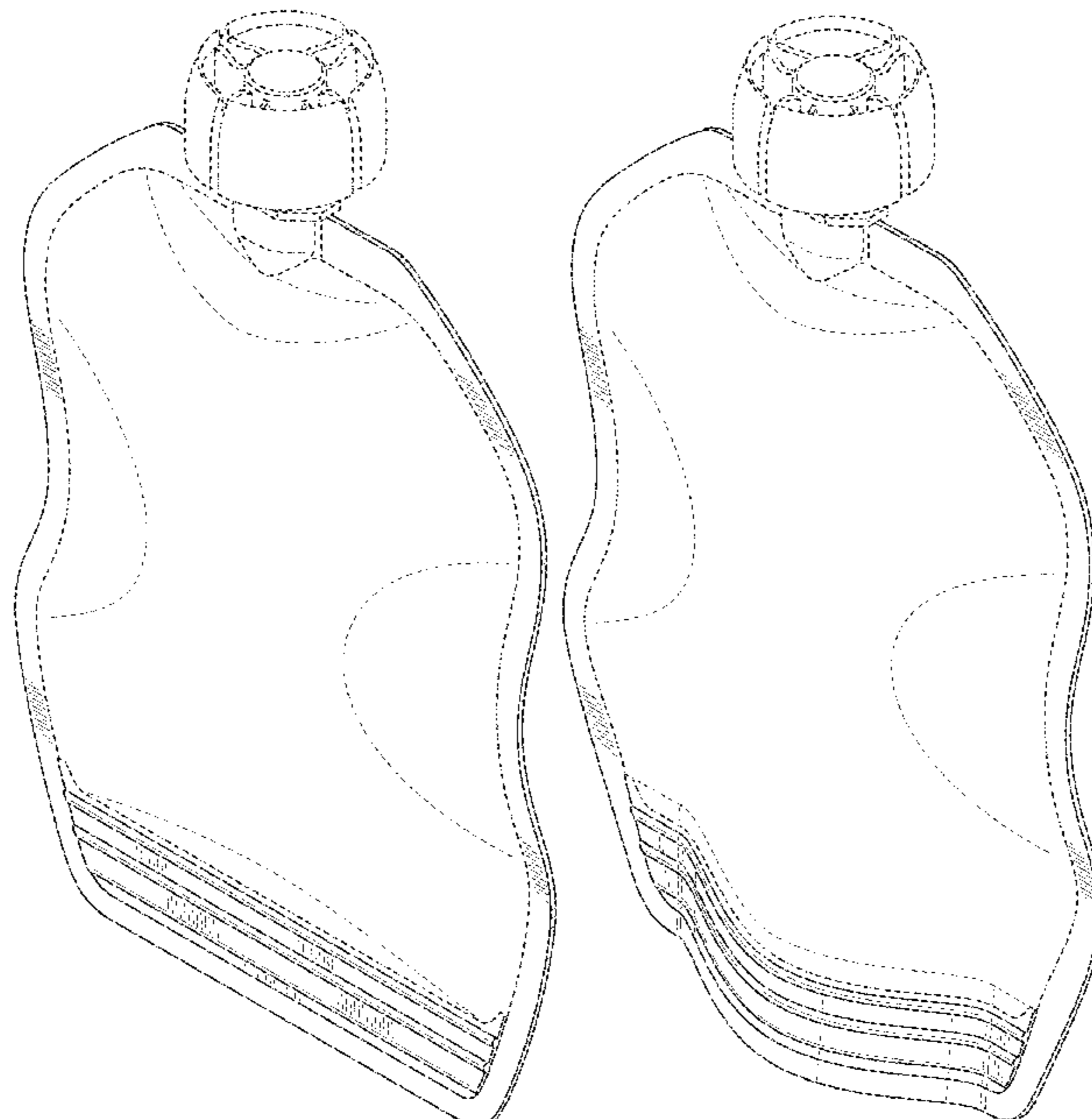

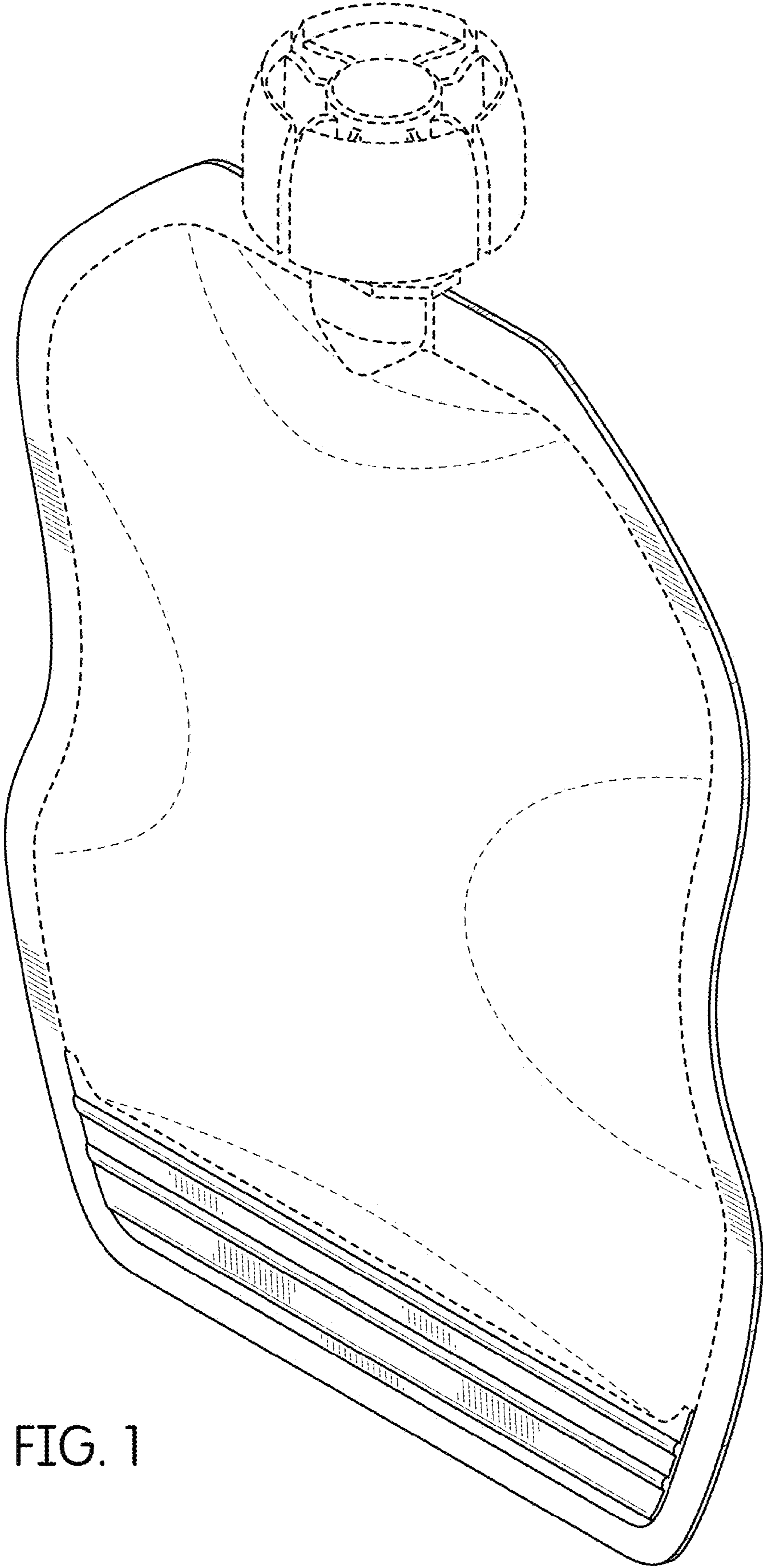

FIG. 1

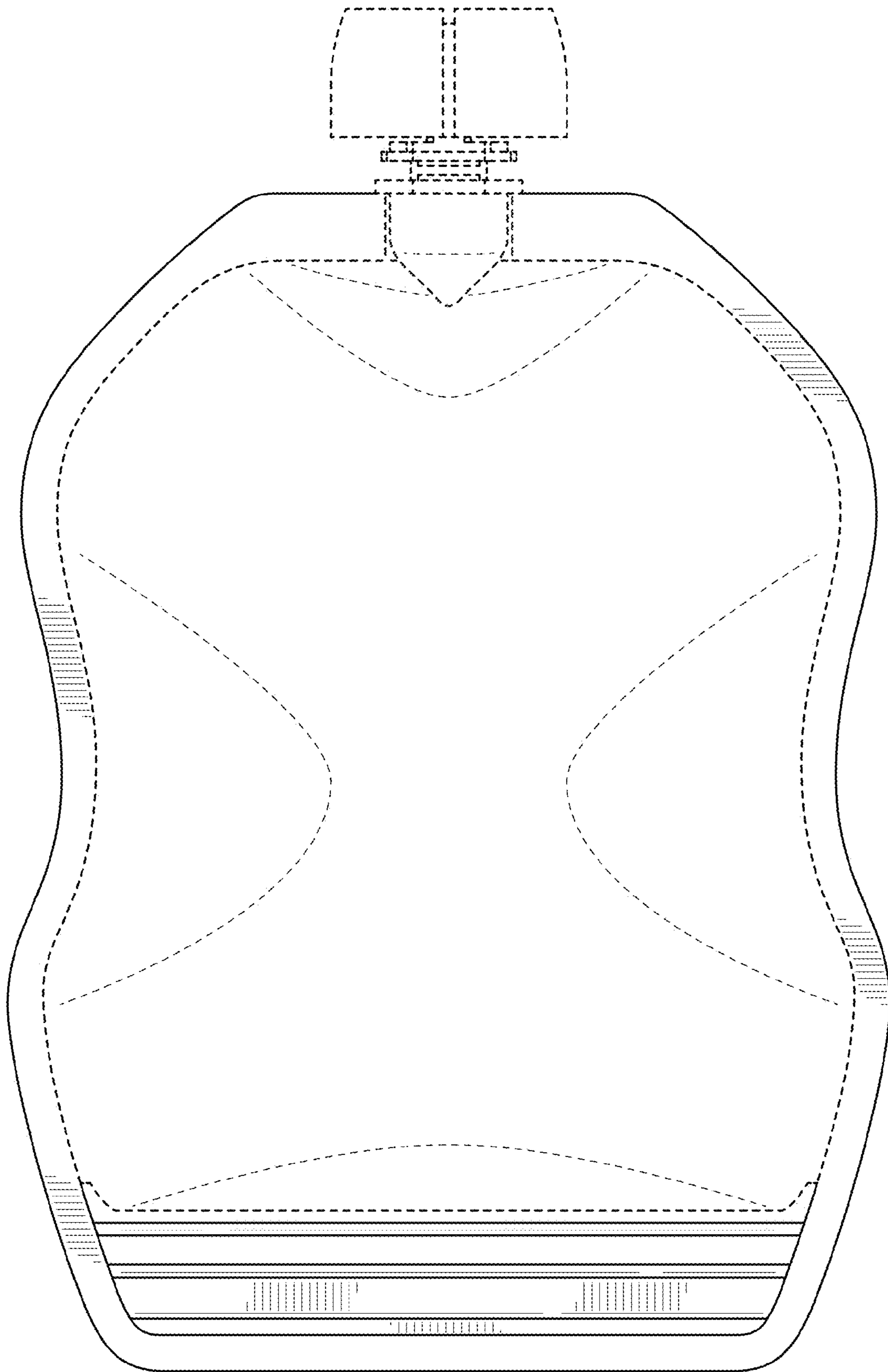

FIG. 2

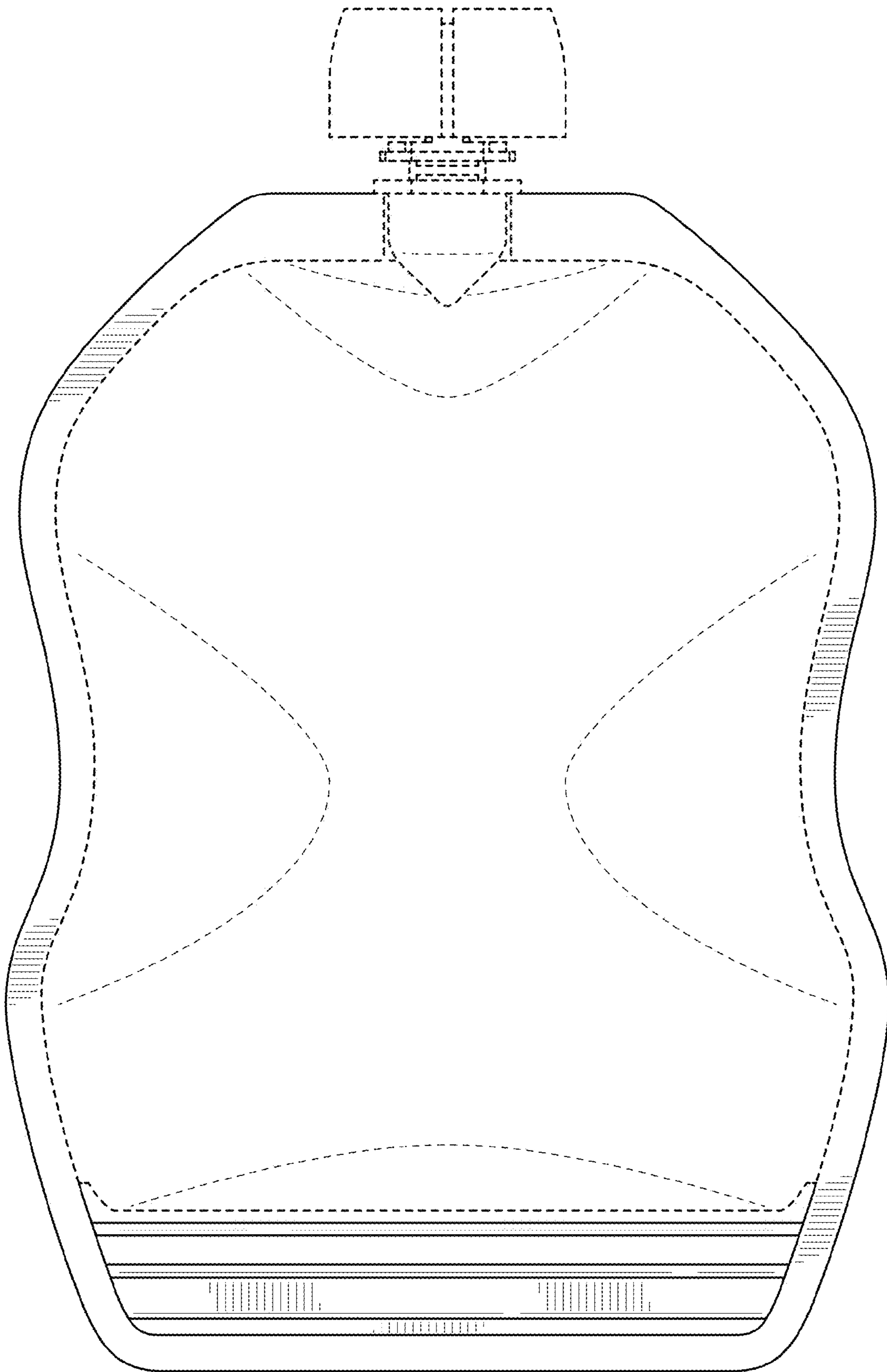

FIG. 3



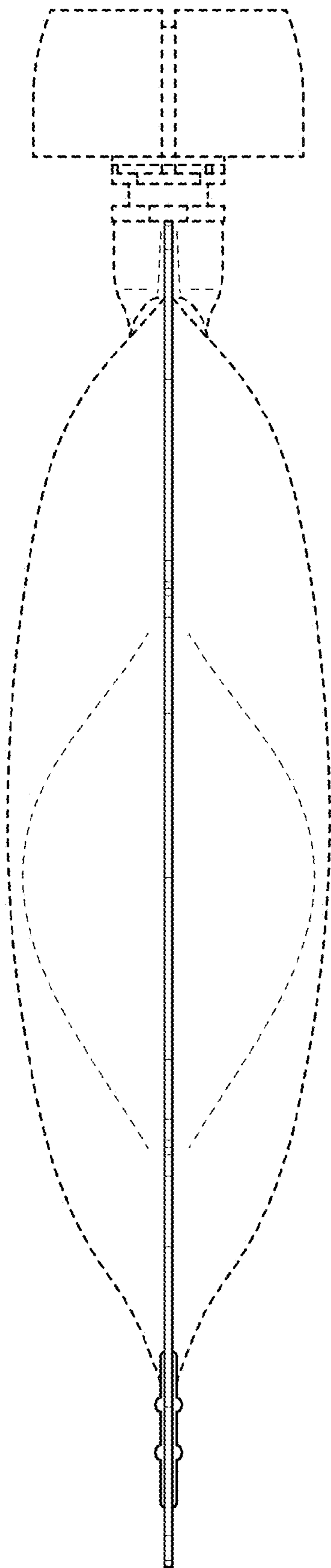

FIG. 4

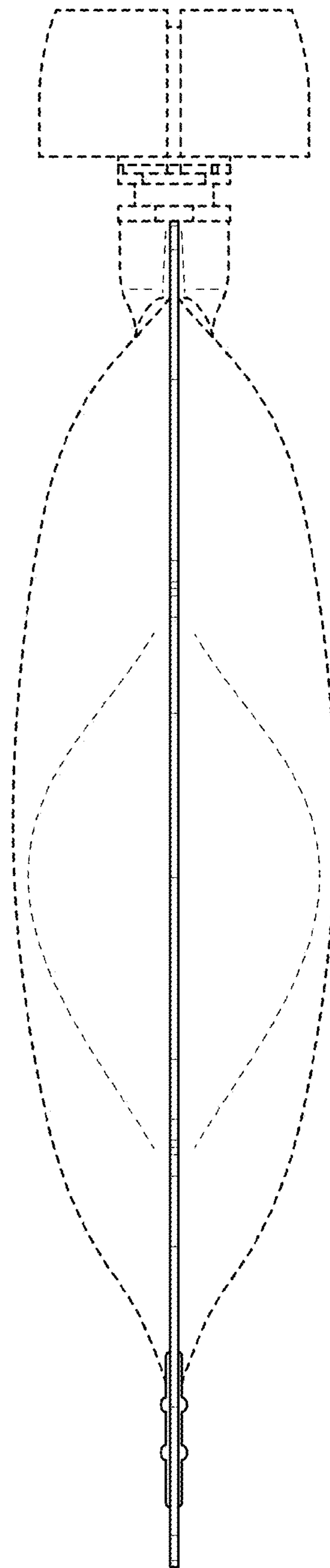

FIG. 5

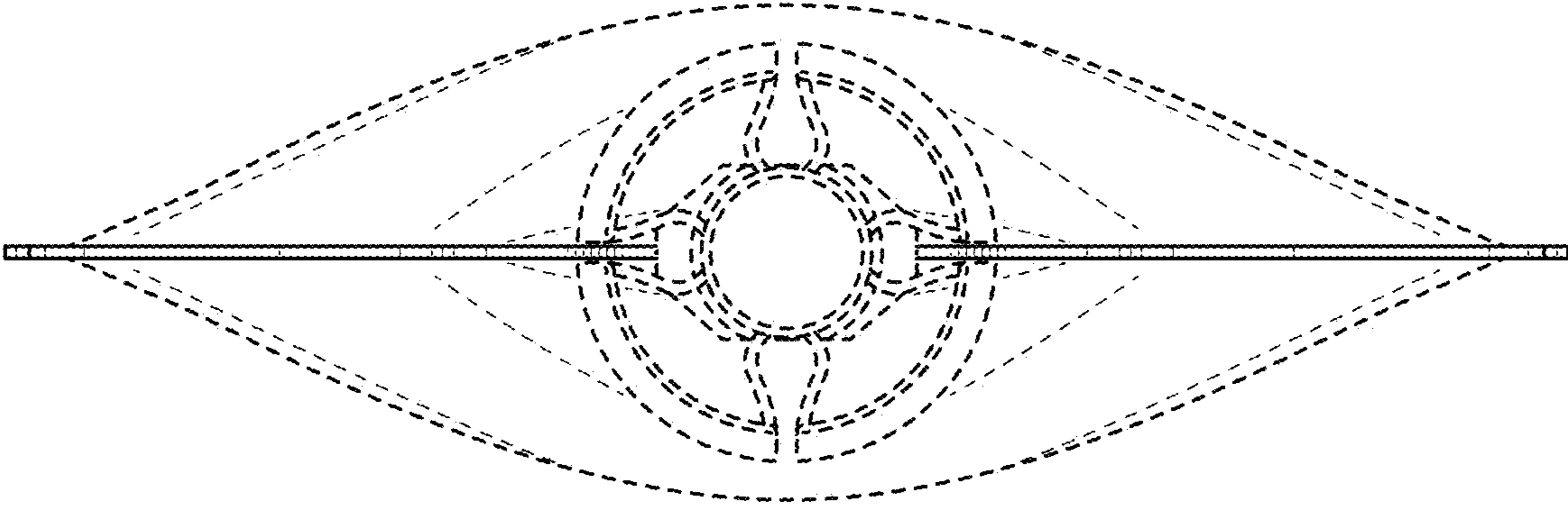

FIG. 6

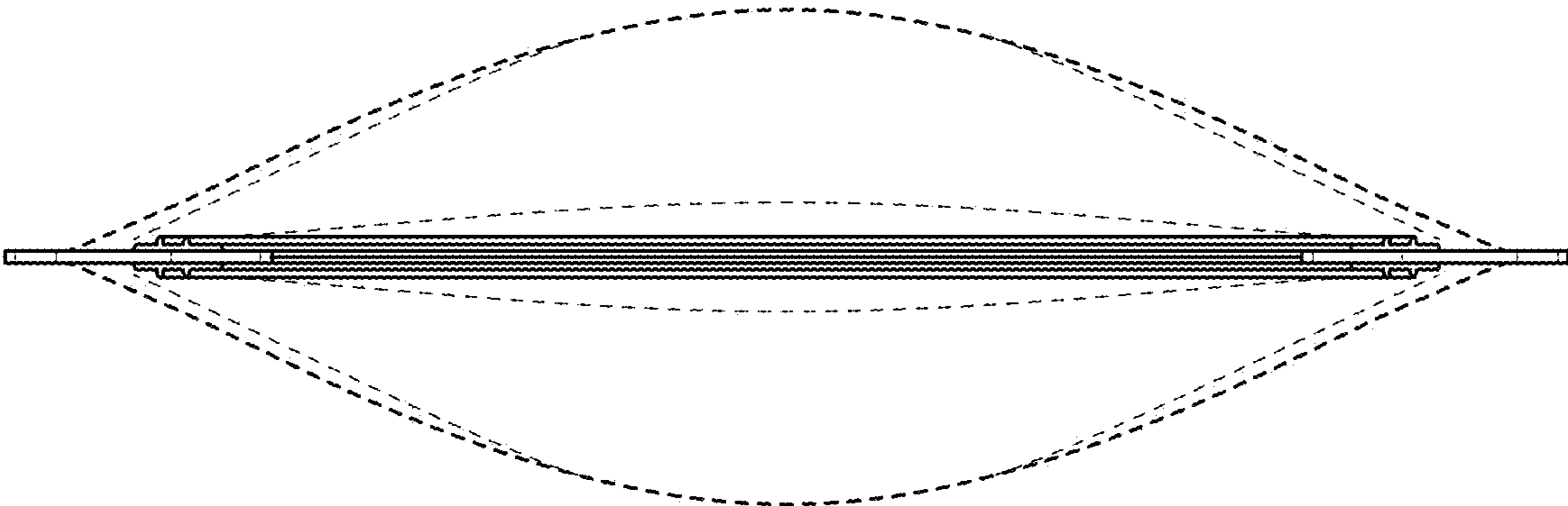

FIG. 7

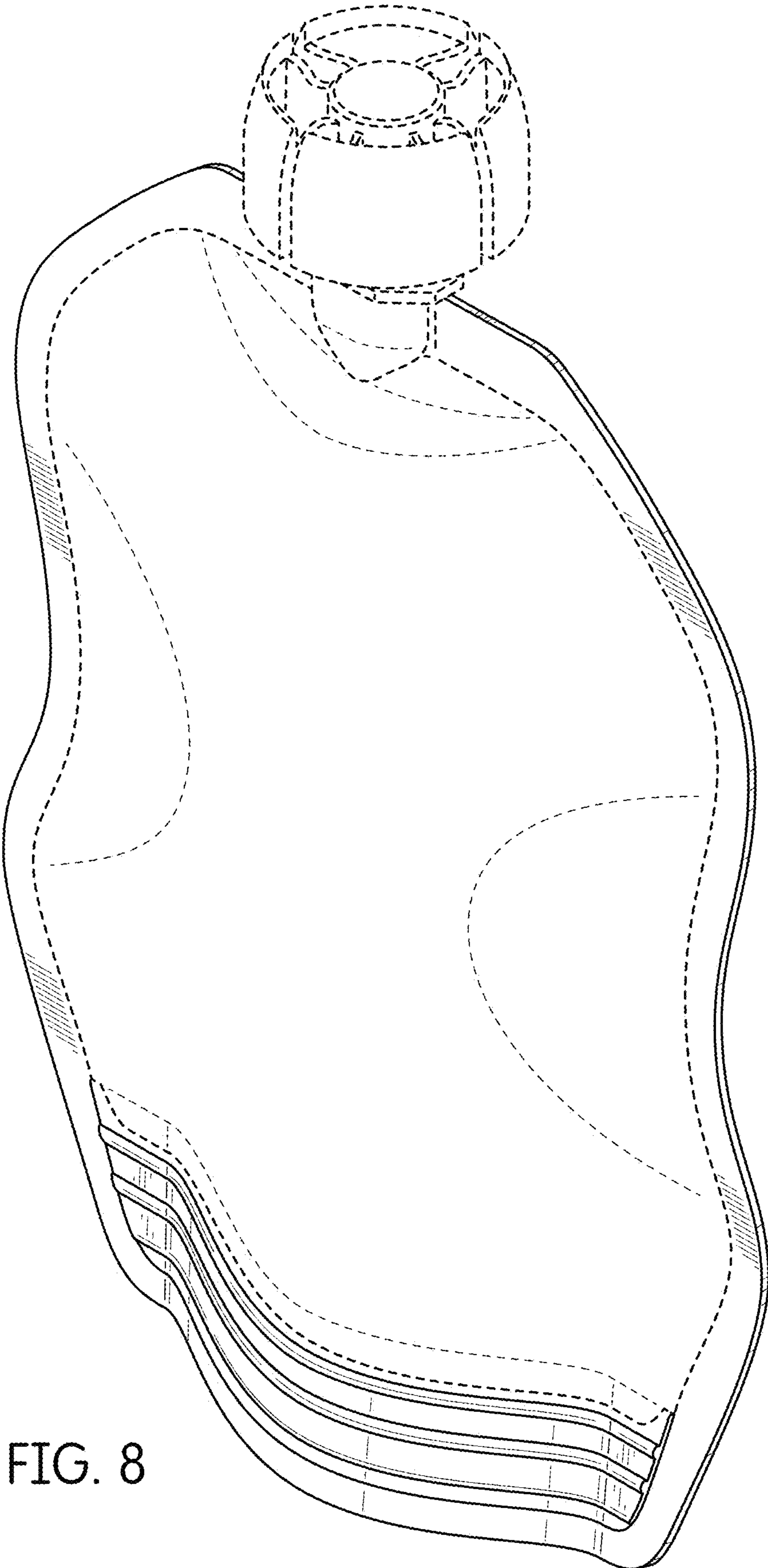

FIG. 8

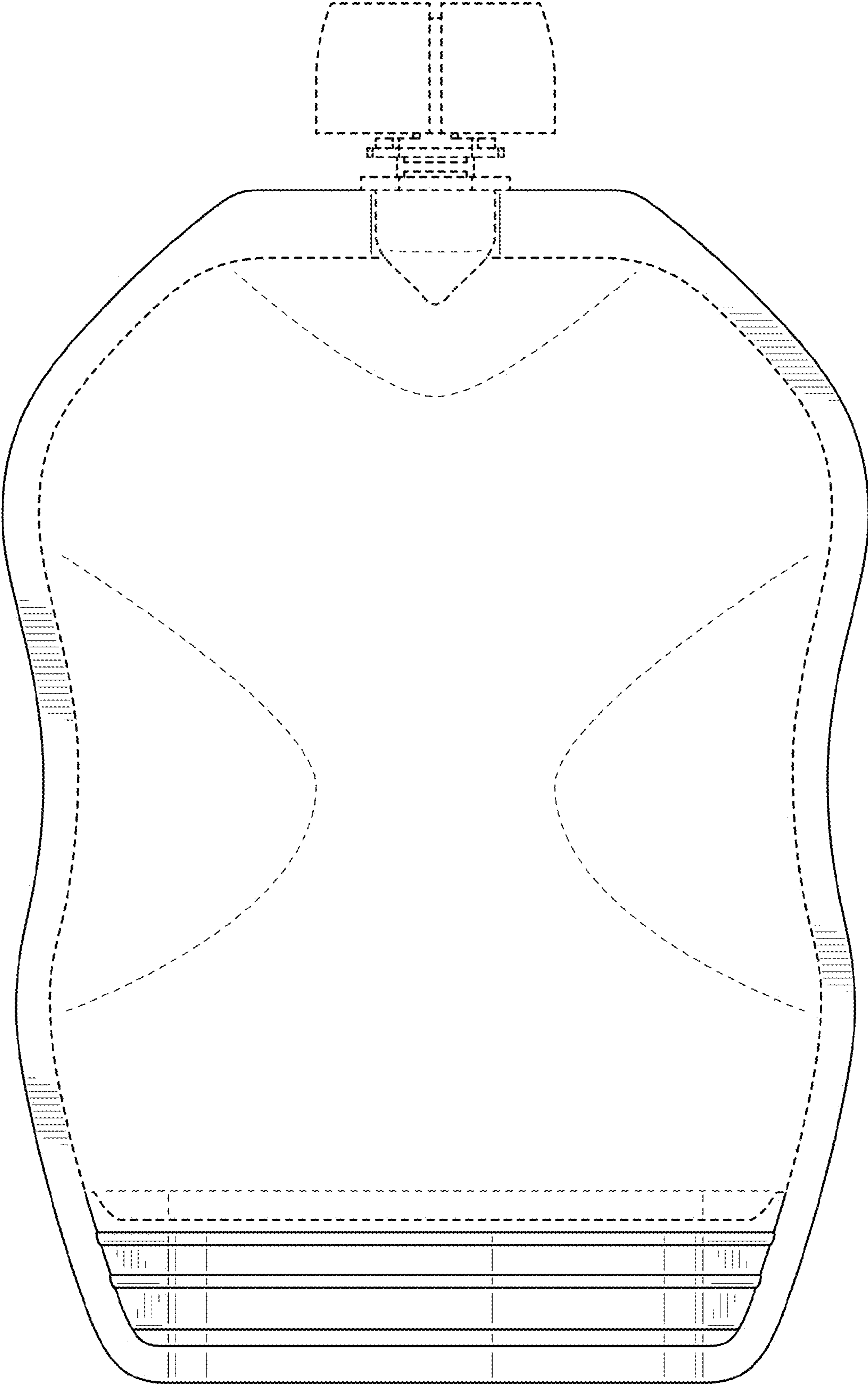

FIG. 9



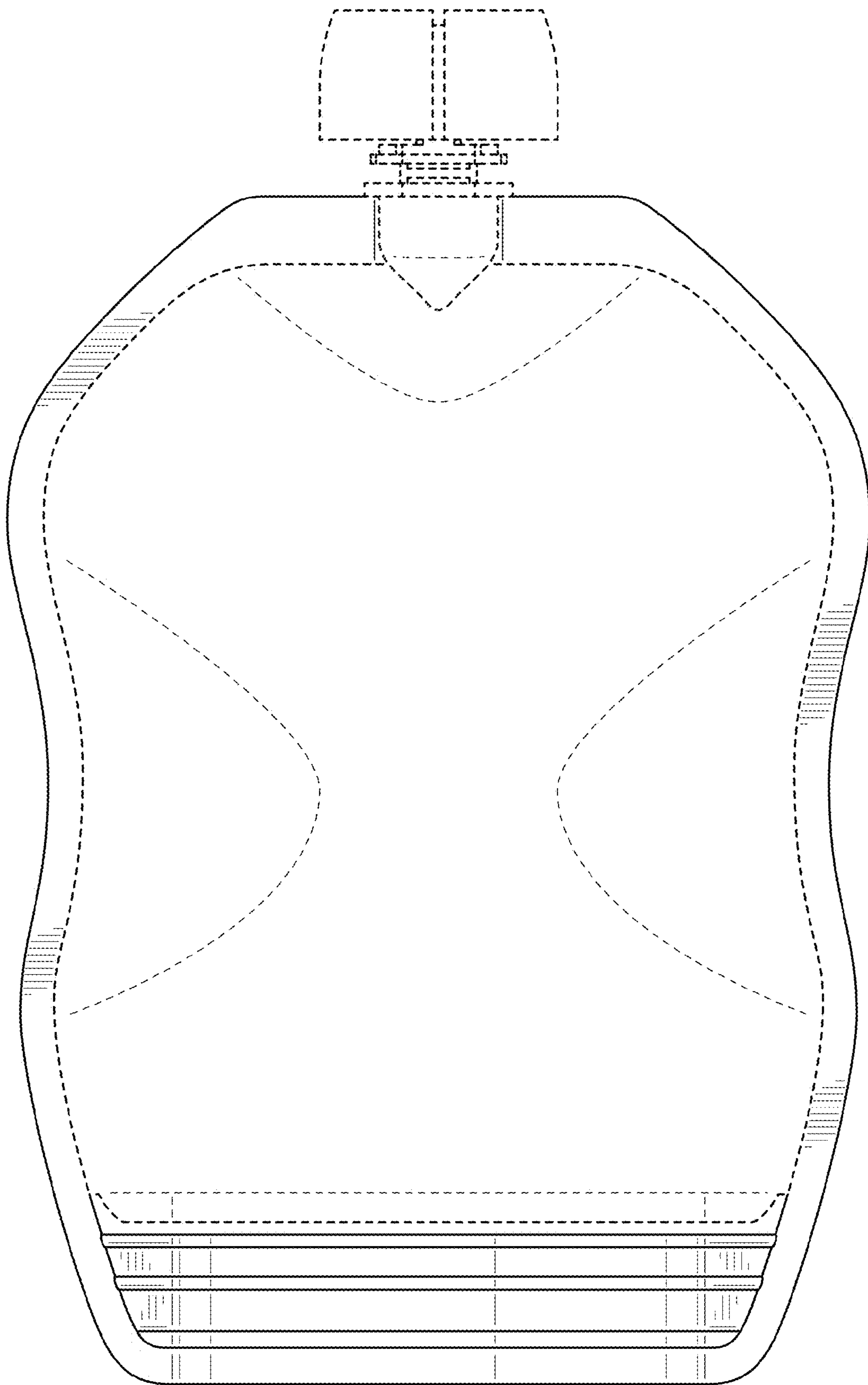

FIG. 10

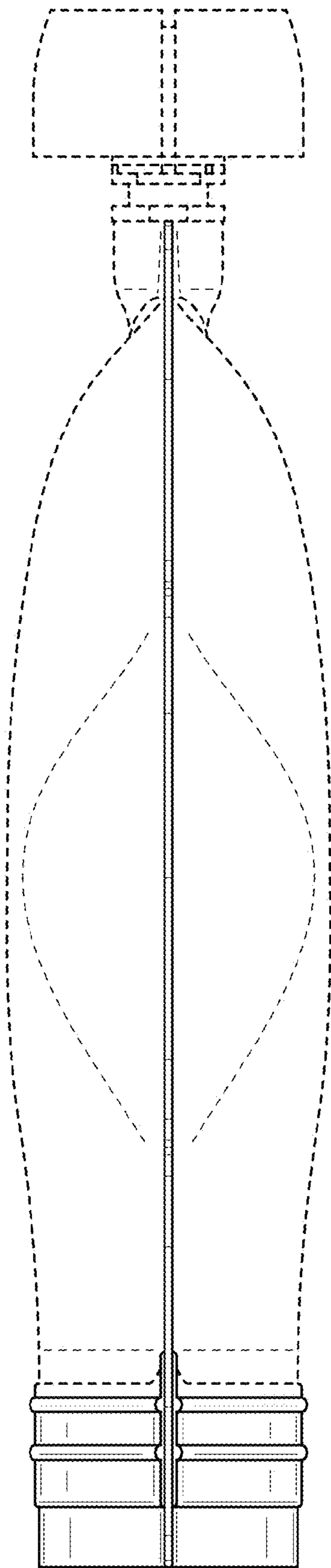

FIG. 11

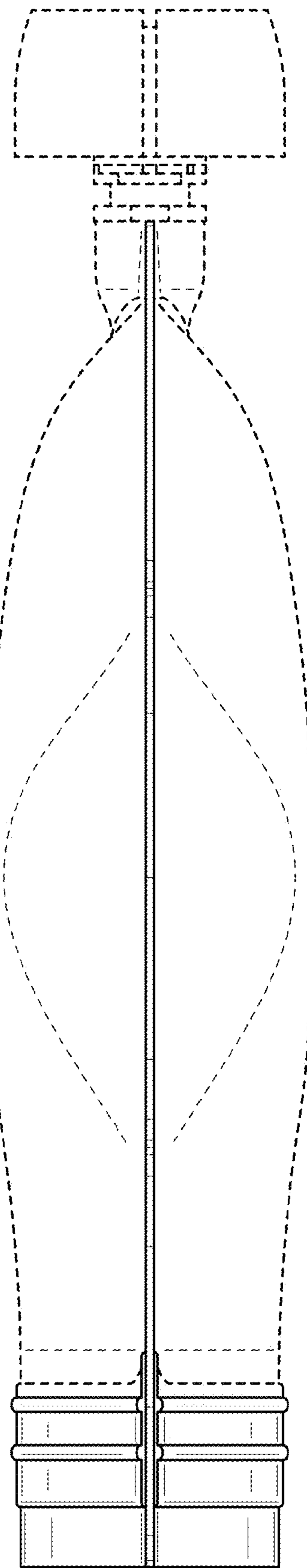

FIG. 12

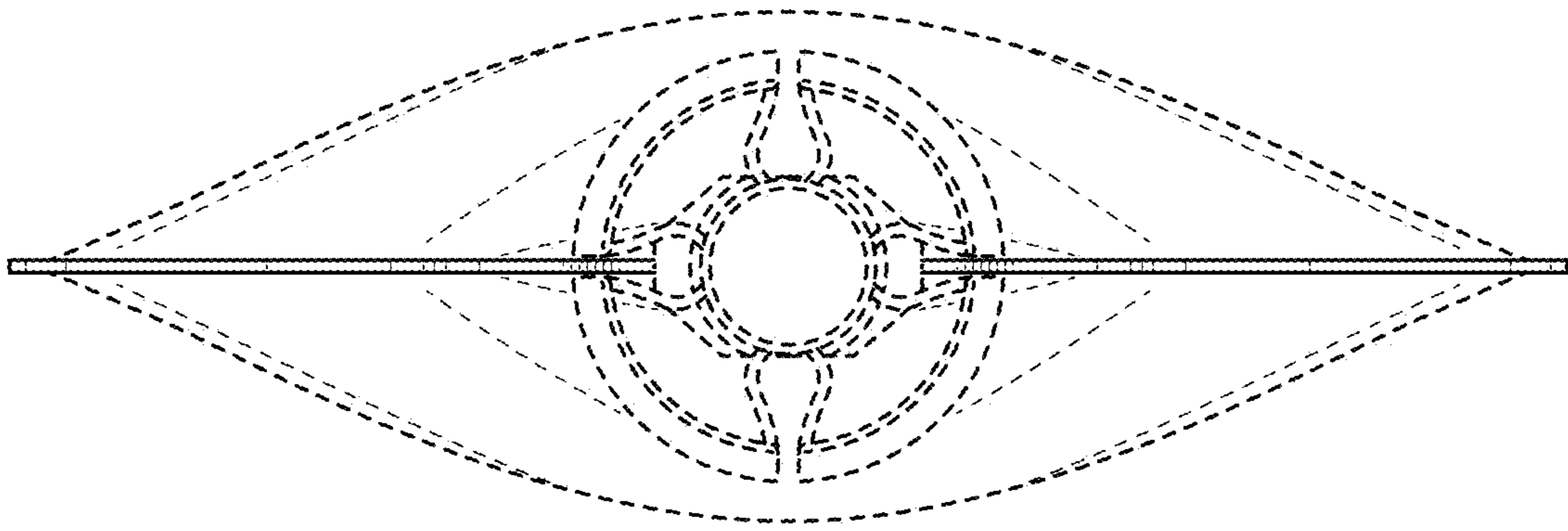

FIG. 13

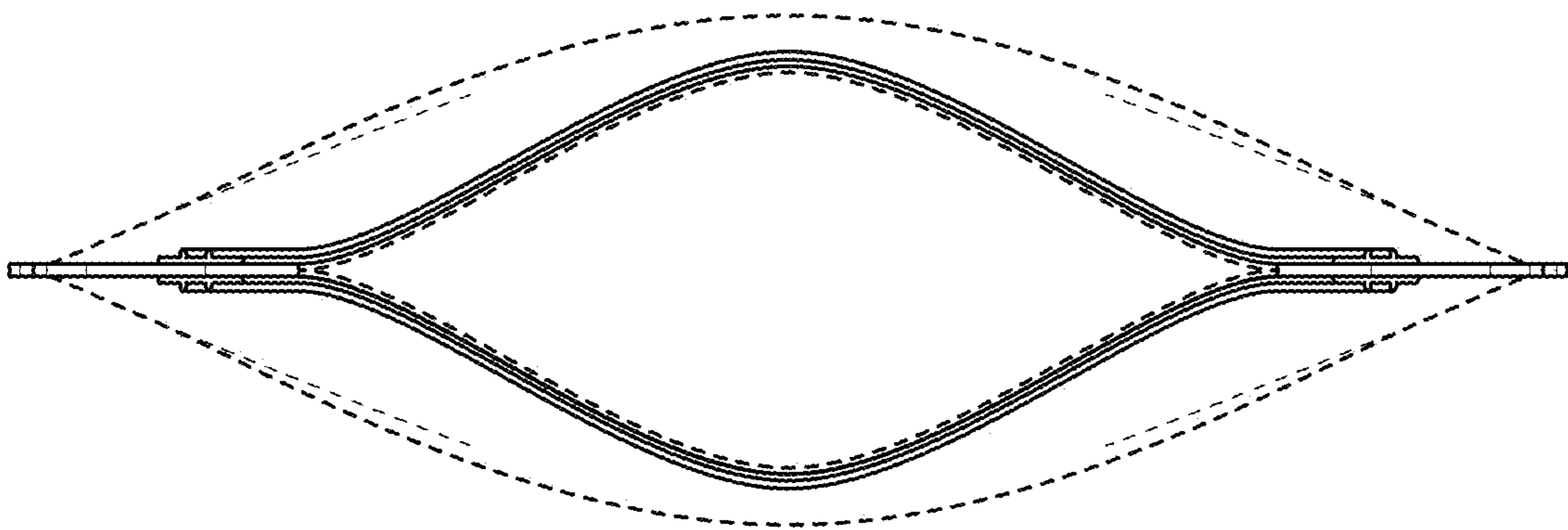

FIG. 14