



US00D939300S

(12) **United States Design Patent** (10) **Patent No.:** **US D939,300 S**
Mitchell (45) **Date of Patent:** **** Dec. 28, 2021**

(54) **WRENCH WITH REMOVABLE JAW INSERTS**

2019 [online]retrieved Oct. 20, 2020, available from internet, www.amazon.com (Year: 2019).*

(Continued)

(71) Applicant: **Private Brand Tools Australia Pty Ltd**, Archerfield (AU)

Primary Examiner — Keli L Hill

(72) Inventor: **David Mitchell**, Carina Heights (AU)

Assistant Examiner — Sara S Sahneh

(73) Assignee: **PRIVATE BRAND TOOLS AUSTRALIA PTY LTD**, Archerfield (AU)

(74) *Attorney, Agent, or Firm* — Armstrong Teasdale LLP

(**) Term: **15 Years**

(57) **CLAIM**

I claim the ornamental design for a wrench with removable jaw inserts, as shown and described.

(21) Appl. No.: **29/694,317**

(22) Filed: **Jun. 10, 2019**

DESCRIPTION

(51) **LOC (13) Cl.** **08-05**

(52) **U.S. Cl.**
USPC **D8/21; D8/28**

(58) **Field of Classification Search**
USPC D8/14, 16-19, 21-29, 51, 52, 54-59;
81/125.1, 177.1, 119, 124.7, 124.3, 186,
81/431, 176.15, 461.1, 99, 98, 100
(Continued)

FIG. 1 is a perspective view of a wrench with removable jaw inserts showing the new design.

FIG. 2 is a front view of the wrench with removable jaw inserts of FIG. 1.

FIG. 3 is a rear view of the wrench with removable jaw inserts of FIG. 1.

FIG. 4 is right side view of the wrench with removable jaw inserts of FIG. 1.

FIG. 5 is a left side view of the wrench with removable jaw inserts of FIG. 1.

FIG. 6 is a top view of the wrench with removable jaw inserts of FIG. 1.

FIG. 7 is a bottom view of the wrench with removable jaw inserts of FIG. 1.

FIG. 8 is an exploded view of the wrench with removable jaw inserts of FIG. 1.

FIG. 9 is a perspective view of a first removable jaw insert of the wrench with removable jaw inserts of FIG. 1.

FIG. 10 is another perspective view of the first removable jaw insert of FIG. 9.

FIG. 11 is a front view of the first removable jaw insert of FIG. 9.

FIG. 12 is a rear view of the first removable jaw insert of FIG. 9.

FIG. 13 is a left side view of the first removable jaw insert of FIG. 9.

(56) **References Cited**

U.S. PATENT DOCUMENTS

3,709,073 A * 1/1973 Kurtz B25B 13/46
81/119
4,406,188 A * 9/1983 Mills B25B 23/10
81/125

(Continued)

FOREIGN PATENT DOCUMENTS

CN 304990619 * 4/2018
CN 306050961 * 2/2020

(Continued)

OTHER PUBLICATIONS

ReNew ,ReNew Non Marring Soft Jaw An Wrenches for Aluminum AN Hose Fittings (-3 AN to -12 AN), Date first available Jan. 7,

(Continued)

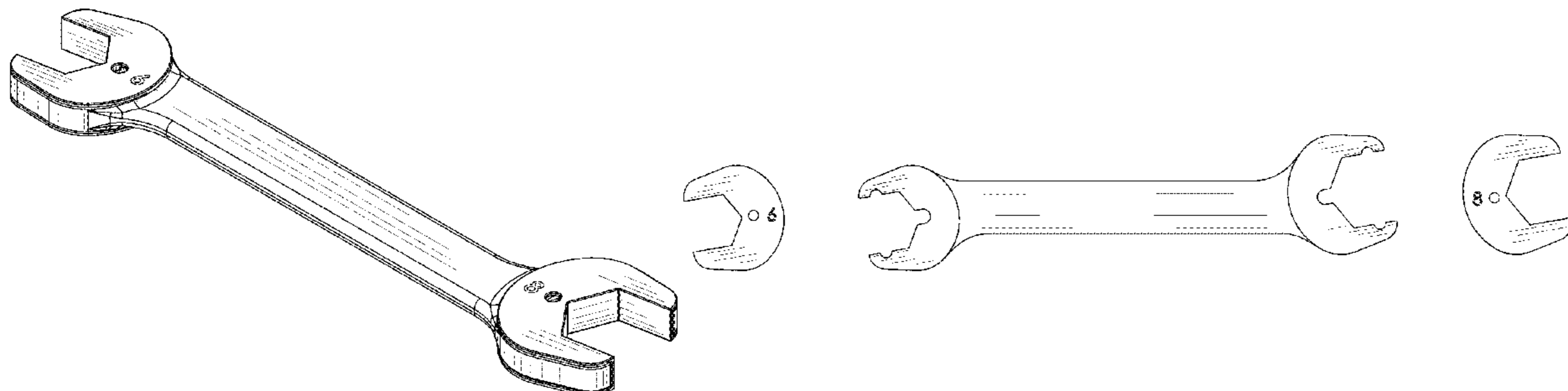

FIG. 14 is a right side view of the first removable jaw insert of FIG. 9.

FIG. 15 is a top view of the first removable jaw insert of FIG. 9.

FIG. 16 is a bottom view of the first removable jaw insert of FIG. 9.

FIG. 17 is a sectional view of the first removable jaw insert of FIG. 9 taken along line "17-17" in FIG. 13.

FIG. 18 is a perspective view of a second removable jaw insert of the wrench with removable jaw inserts of FIG. 1.

FIG. 19 is another perspective view of the second removable jaw insert of FIG. 18.

FIG. 20 is a front view of the second removable jaw insert of FIG. 18.

FIG. 21 is a rear view of the second removable jaw insert of FIG. 18.

FIG. 22 is a left side view of the second removable jaw insert of FIG. 18.

FIG. 23 is a right side view of the second removable jaw insert of FIG. 18.

FIG. 24 is a top view of the second removable jaw insert of FIG. 18.

FIG. 25 is a bottom view of the second removable jaw insert of FIG. 18; and,

FIG. 26 is a sectional view of the second removable jaw insert of FIG. 18 taken along line "26-26" in FIG. 23.

The broken line showing of the wrench with removable jaw inserts is for the purpose of illustrating portions of the article and forms no part of the claimed design.

1 Claim, 15 Drawing Sheets

(58) **Field of Classification Search**

CPC B25B 13/14; B25B 13/06; B25B 13/04; B25B 13/46; B25B 13/00; B25B 7/02; B25B 13/48; B25B 13/16; B25B 13/505;

B25B 13/5058; B25B 23/0007; B25B 13/28

See application file for complete search history.

(56)

References Cited

U.S. PATENT DOCUMENTS

D357,618	S	4/1995	Macor	
D440,839	S *	4/2001	Lee	D8/28
D445,014	S	7/2001	Patrick et al.	
D461,107	S	8/2002	Pitt	
D465,977	S *	11/2002	Chen	D8/28
D473,767	S	4/2003	Olson	
D473,768	S *	4/2003	Gilmore	D8/28
D485,144	S	1/2004	Levine et al.	
6,691,595	B2 *	2/2004	Hsien	B25B 13/04 16/113.1
6,784,799	B2 *	8/2004	Hsien	B25B 23/1425 340/668
D517,879	S	3/2006	Hsien	
7,117,767	B1	10/2006	Kiat	
D596,908	S *	7/2009	Clay	D8/27
D675,076	S	1/2013	Oachs et al.	
2011/0239831	A1 *	10/2011	Cole	B25B 23/0071 81/125
2014/0060261	A1 *	3/2014	Liau	B25B 13/04 81/125.1
2014/0345428	A1 *	11/2014	Buchanan	B25B 13/46 81/177.2
2019/0321946	A1 *	10/2019	MacDonald	B25G 1/043

FOREIGN PATENT DOCUMENTS

GB	2103100	*	7/2001
GB	4007153	*	4/2008
JP	D1289886	*	11/2005

OTHER PUBLICATIONS

Mateo Tools, 4 Piece Soft Jaw Wrenches, available at <<https://www.matcotools.com/catalog/product/MSTSJW4/4-piece-soft-jaw-wrenches/>>, accessed May 1, 2019.

* cited by examiner

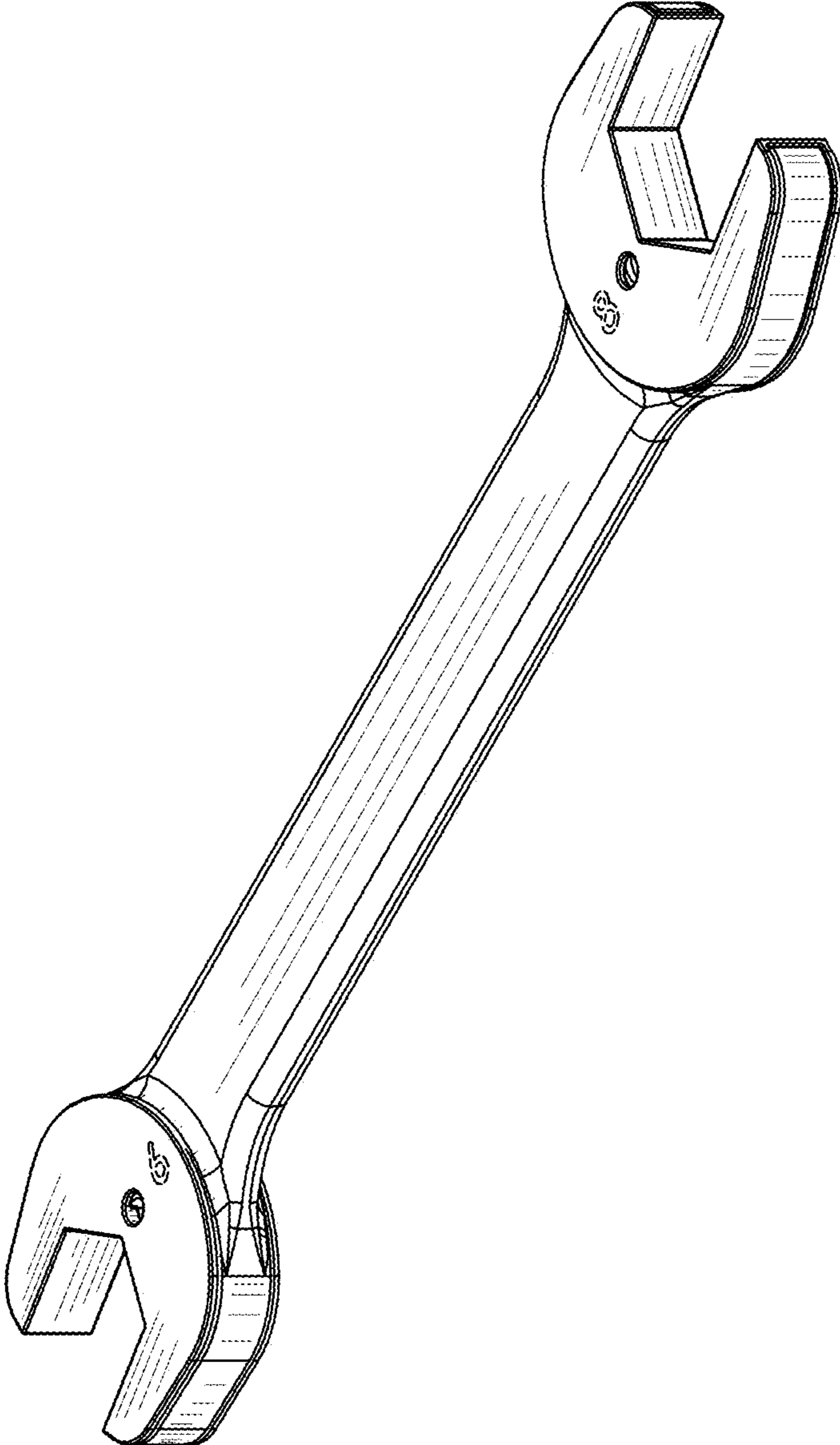

FIG. 1

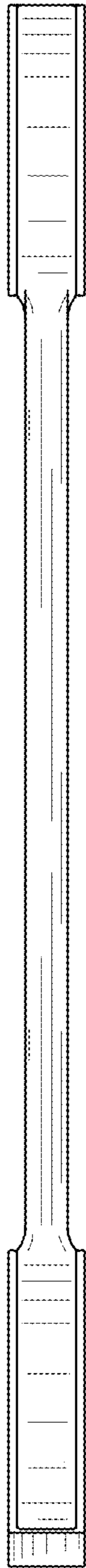

FIG. 2

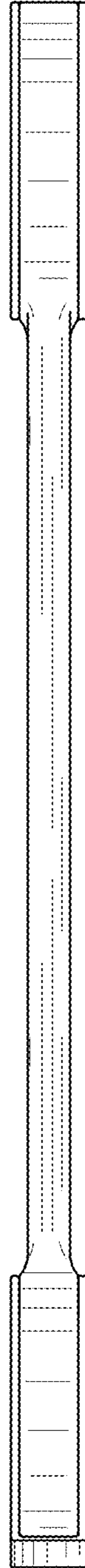

FIG. 3

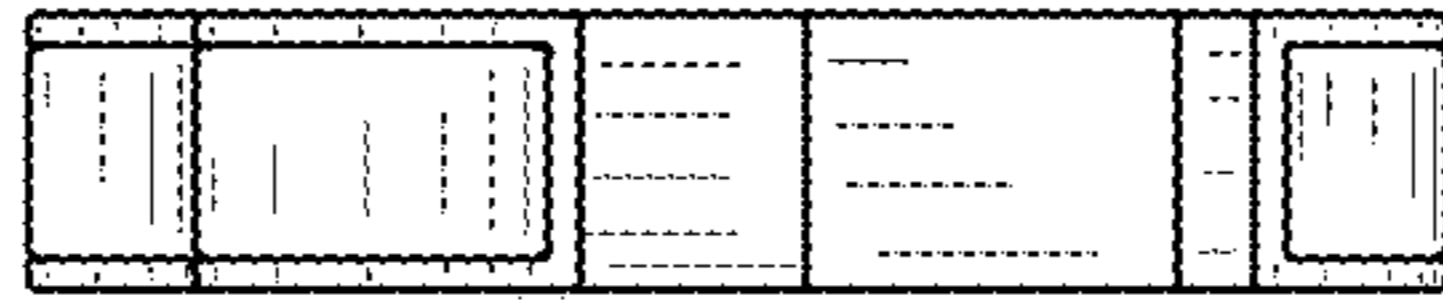

FIG. 4

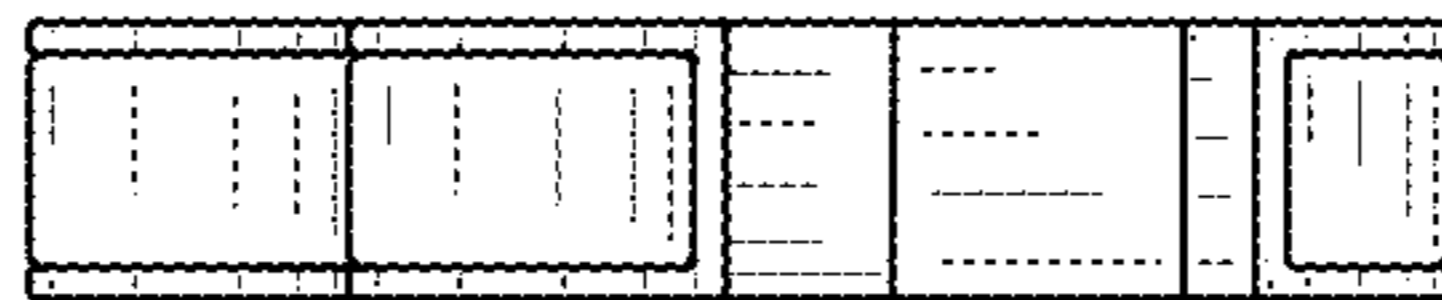

FIG. 5

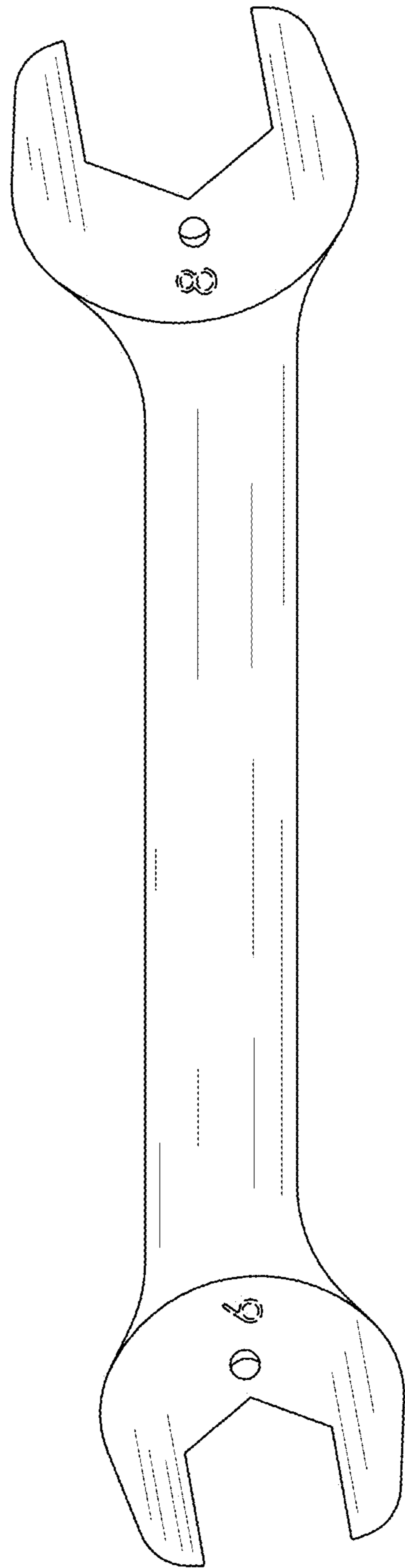

FIG. 6

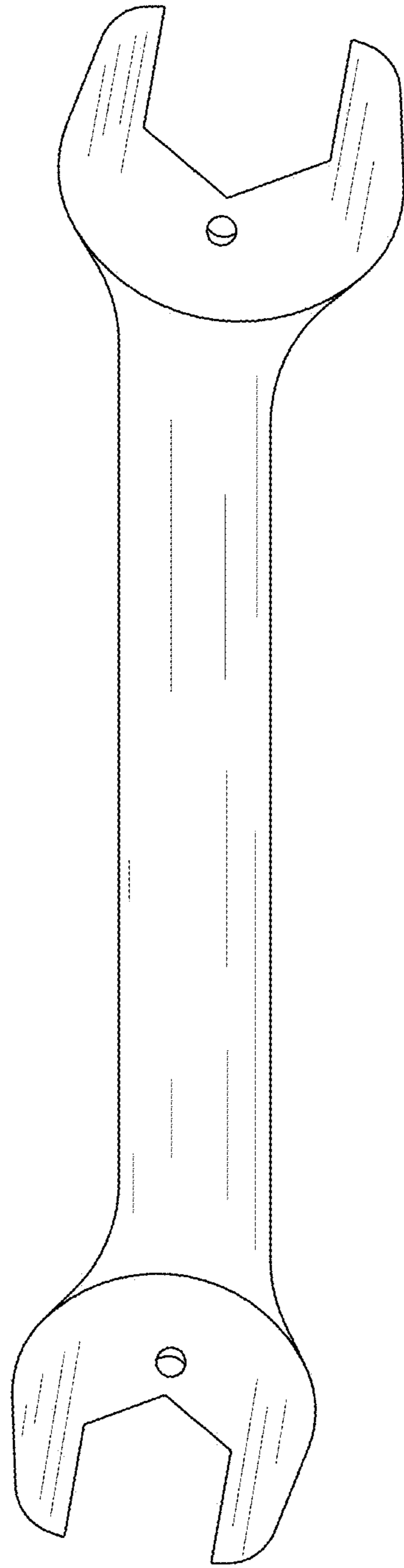

FIG. 7

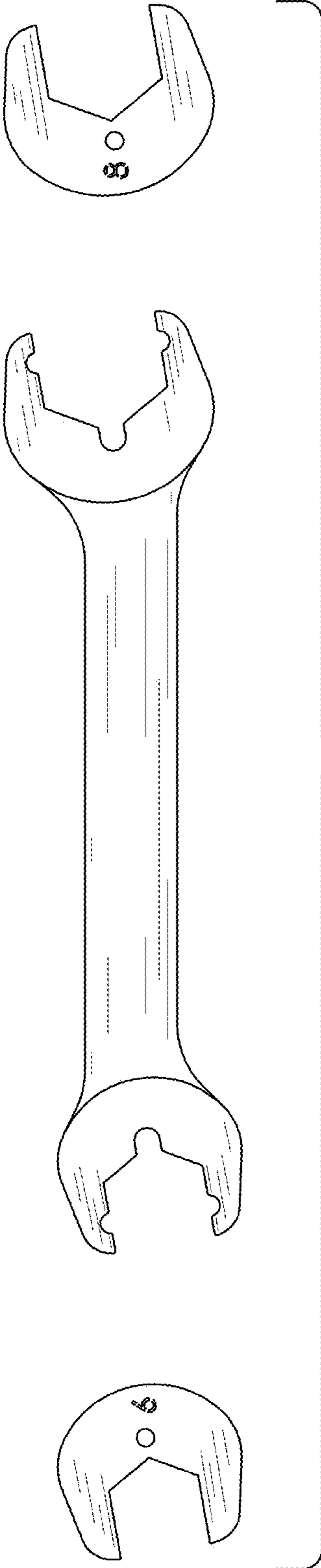

FIG. 8

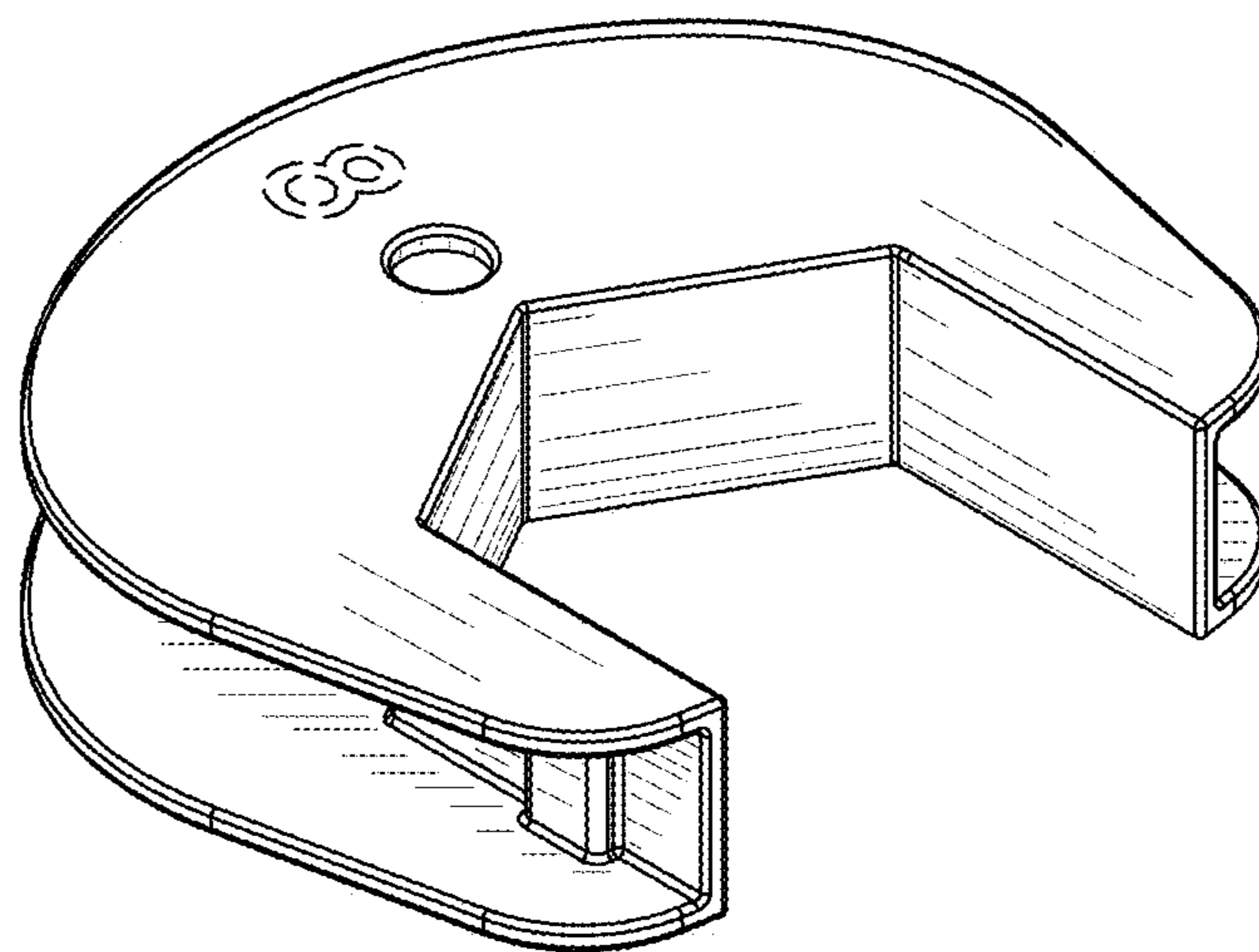

FIG. 9

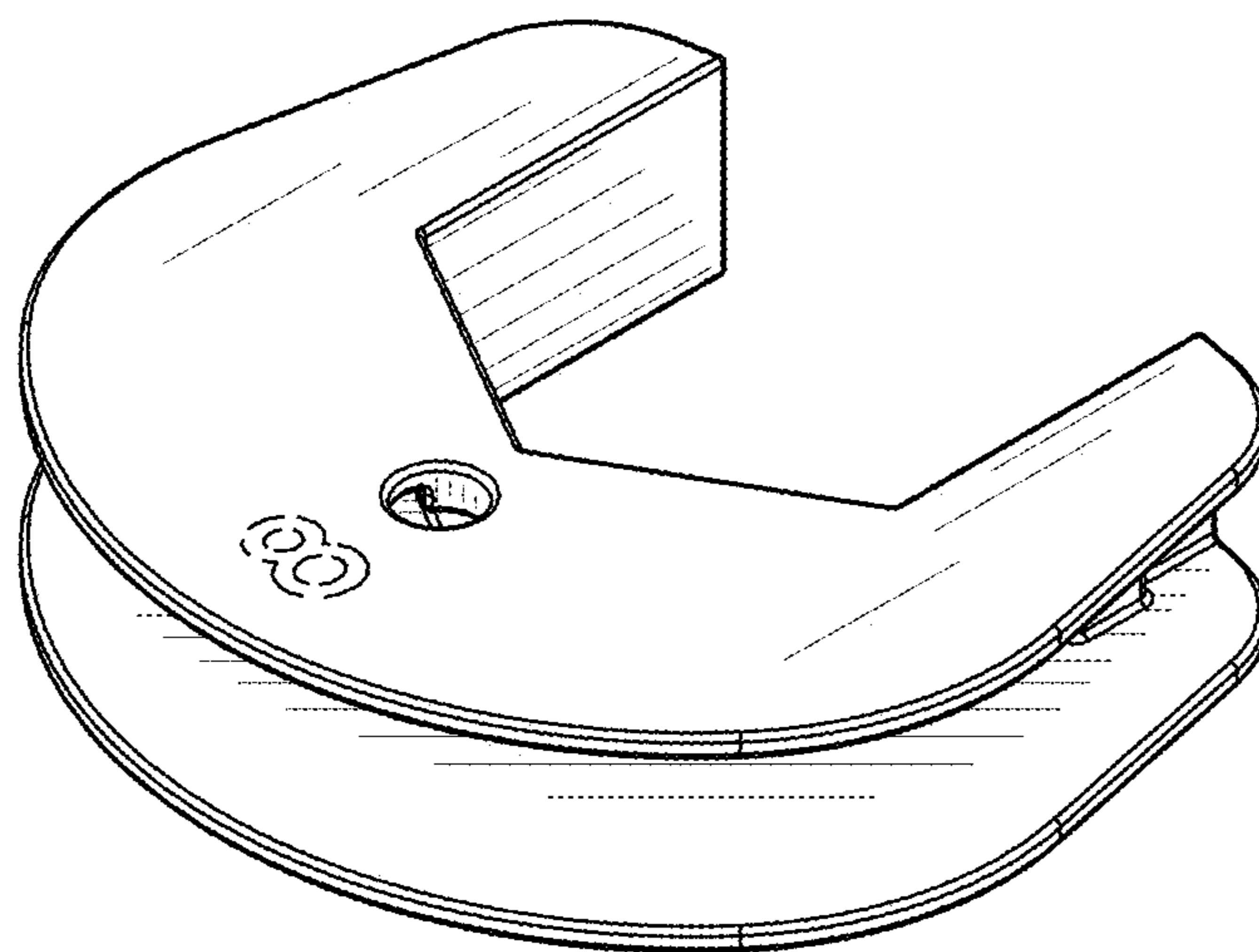

FIG. 10

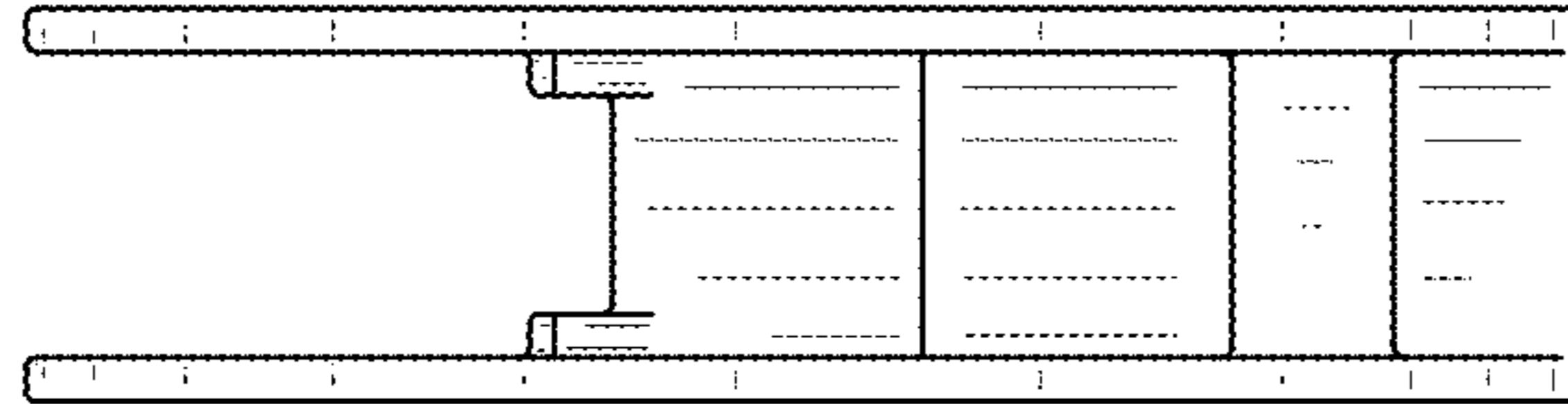

FIG. 11

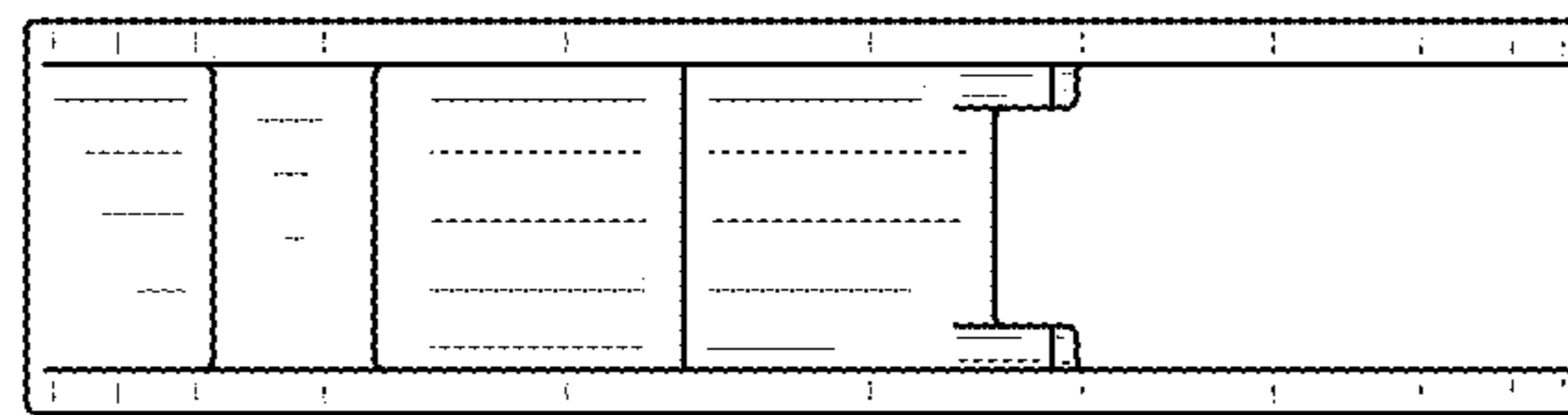

FIG. 12

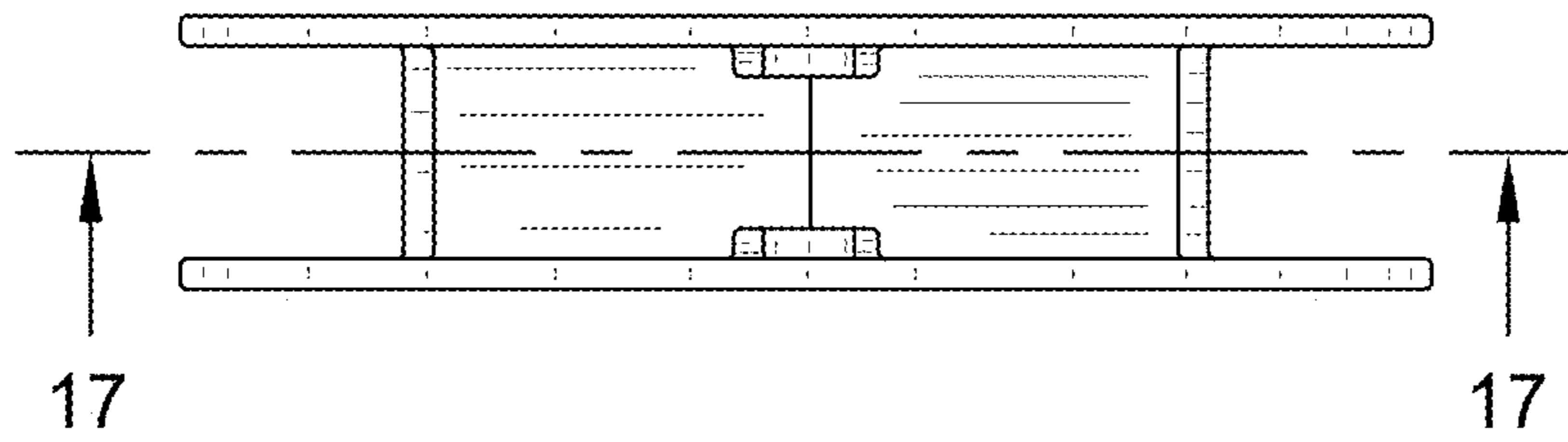

FIG. 13

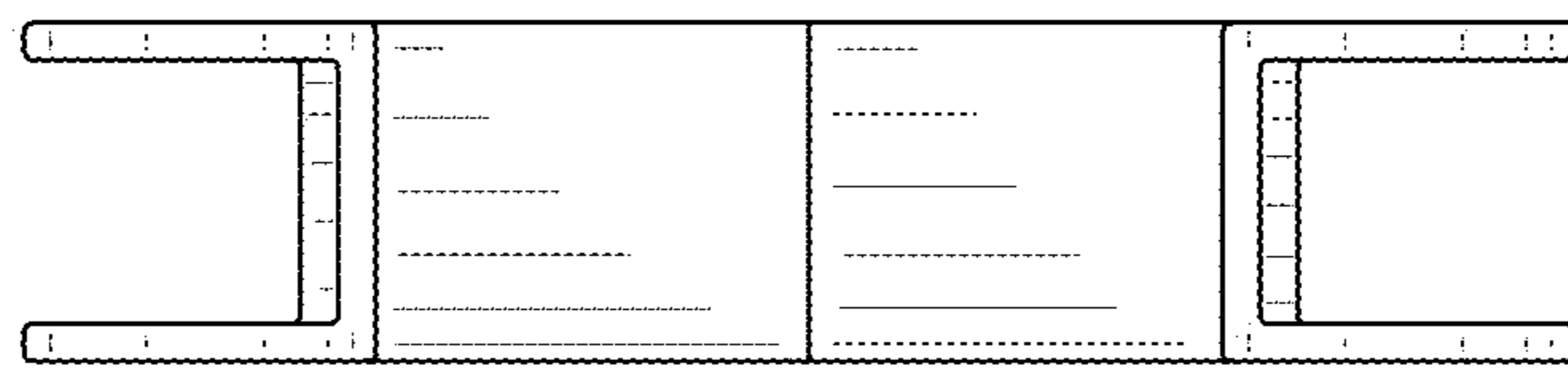

FIG. 14

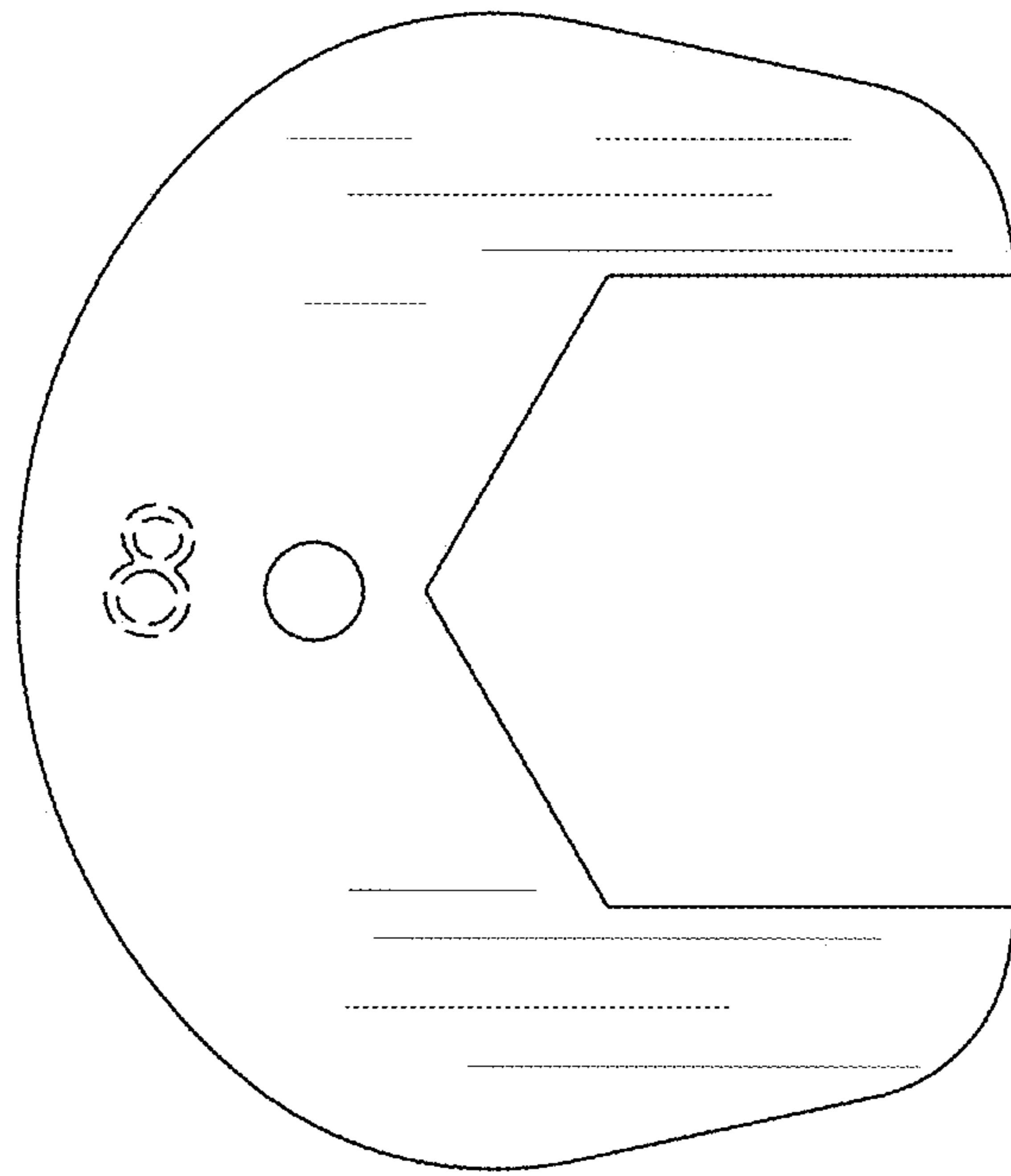

FIG. 15

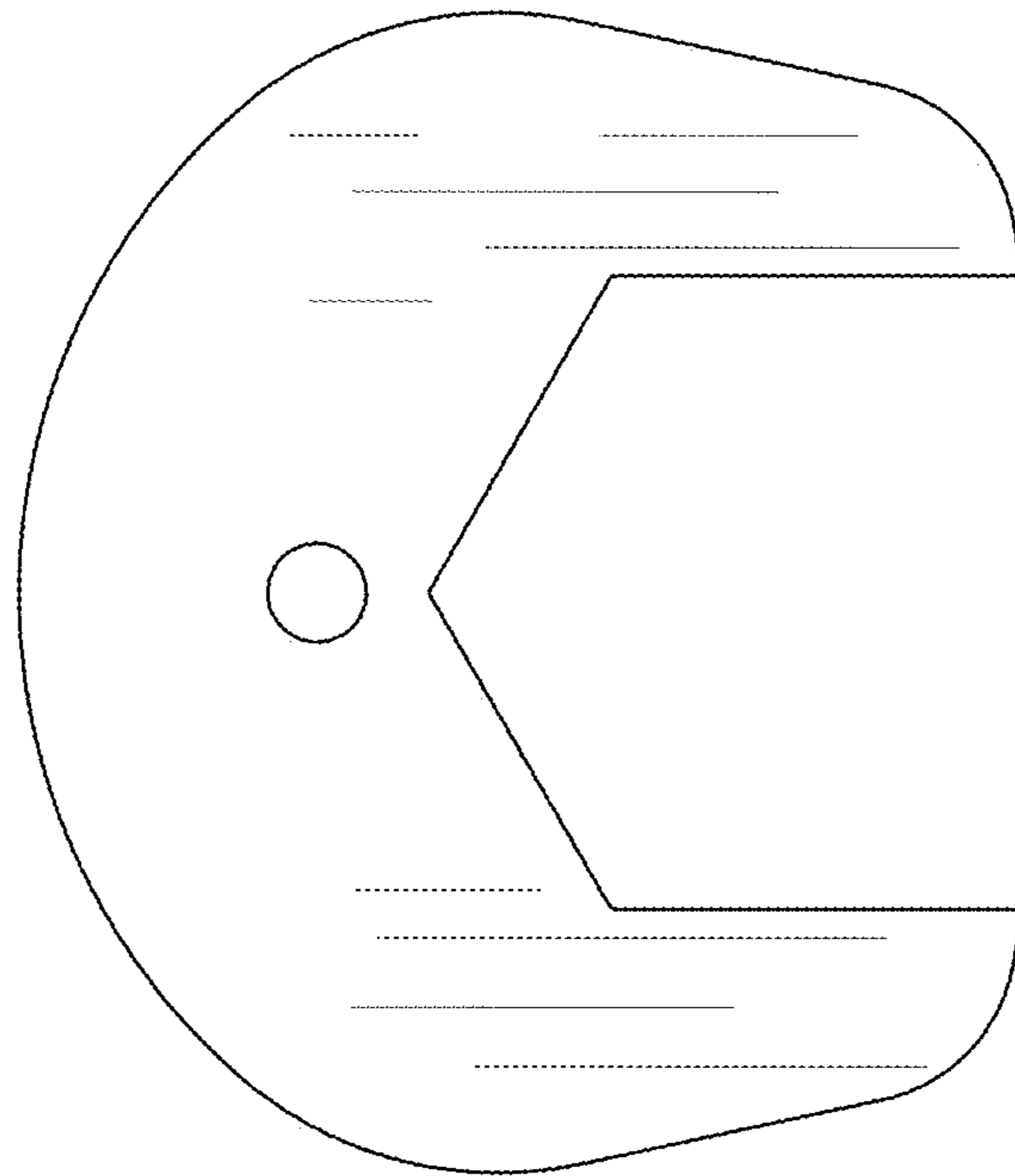

FIG. 16

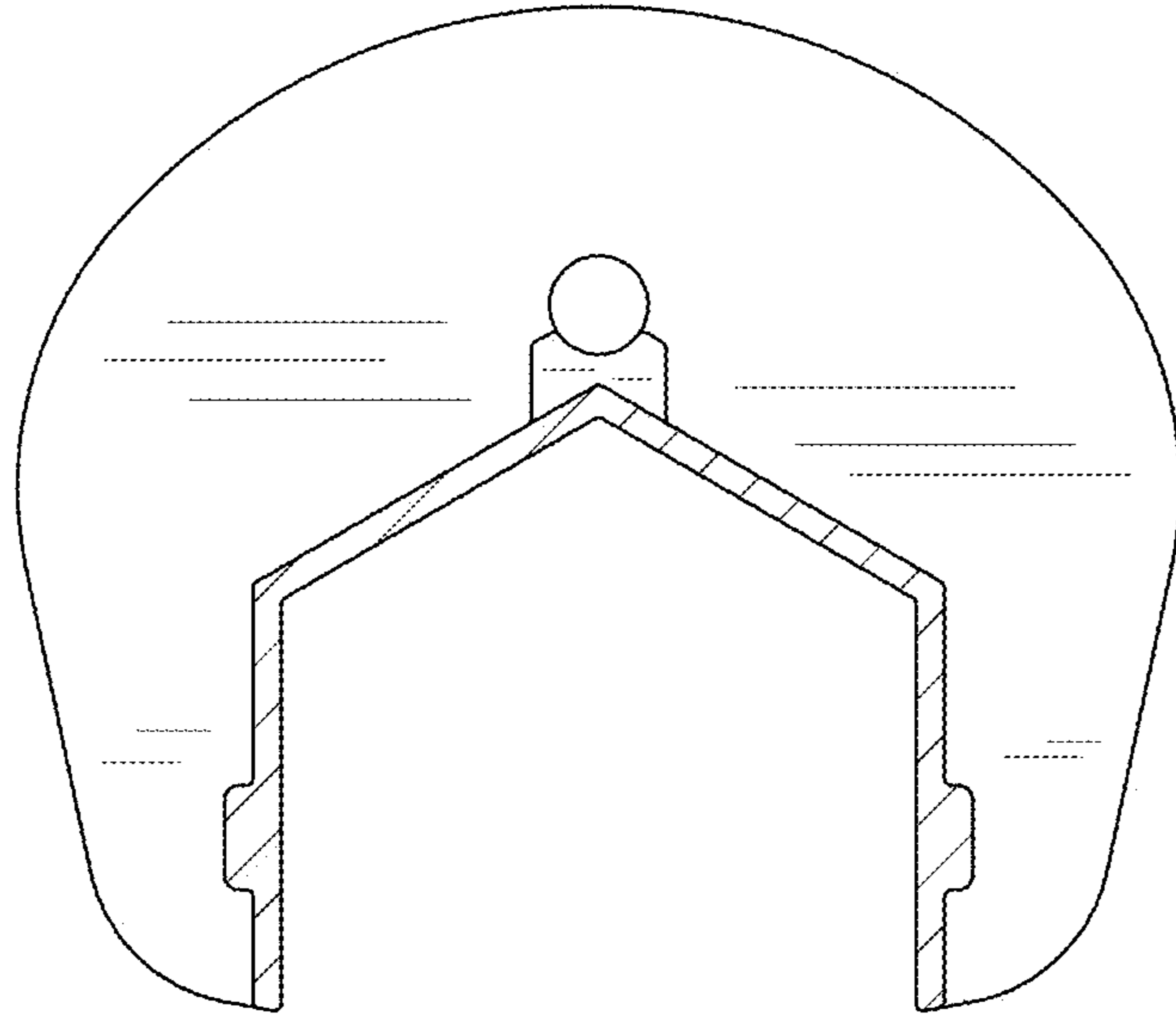

FIG. 17

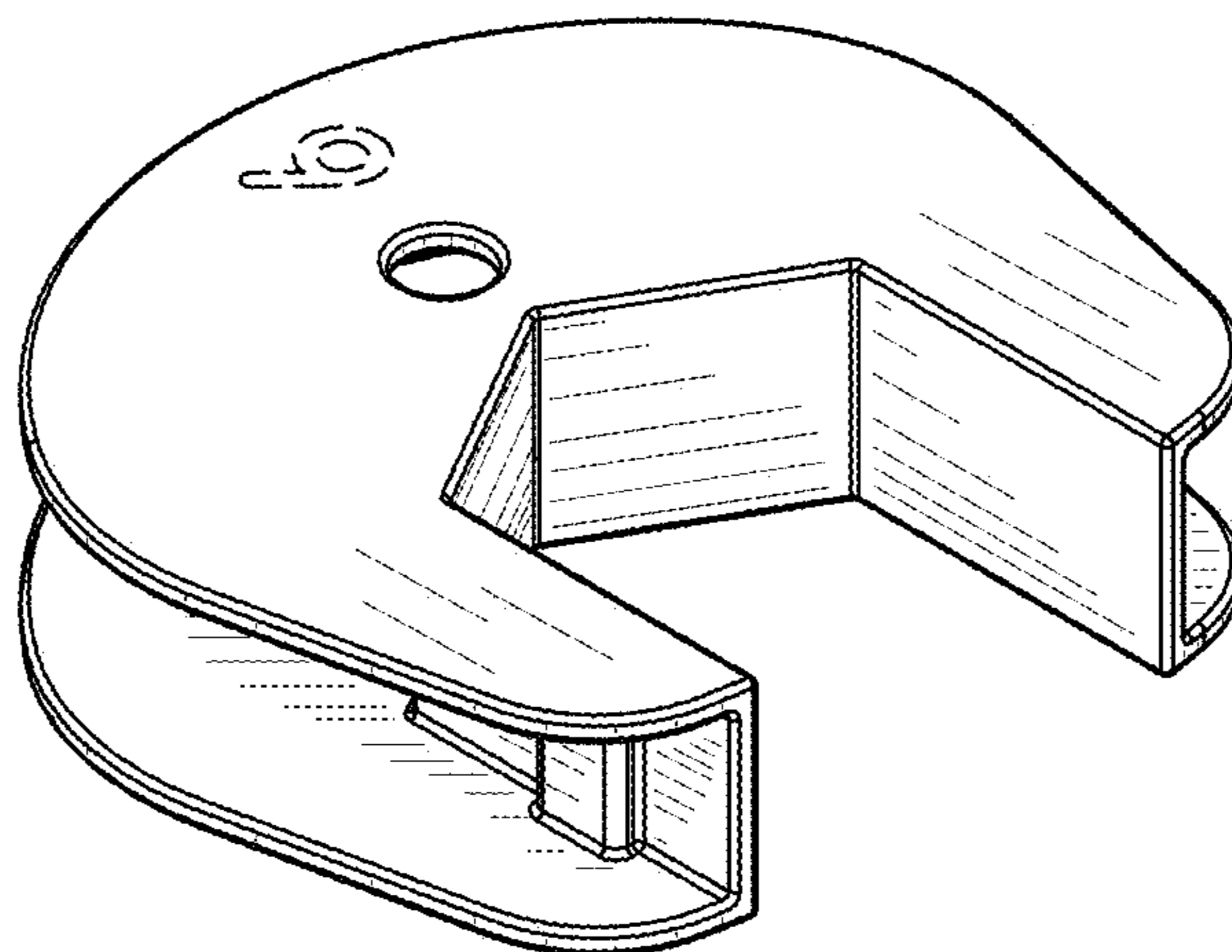

FIG. 18

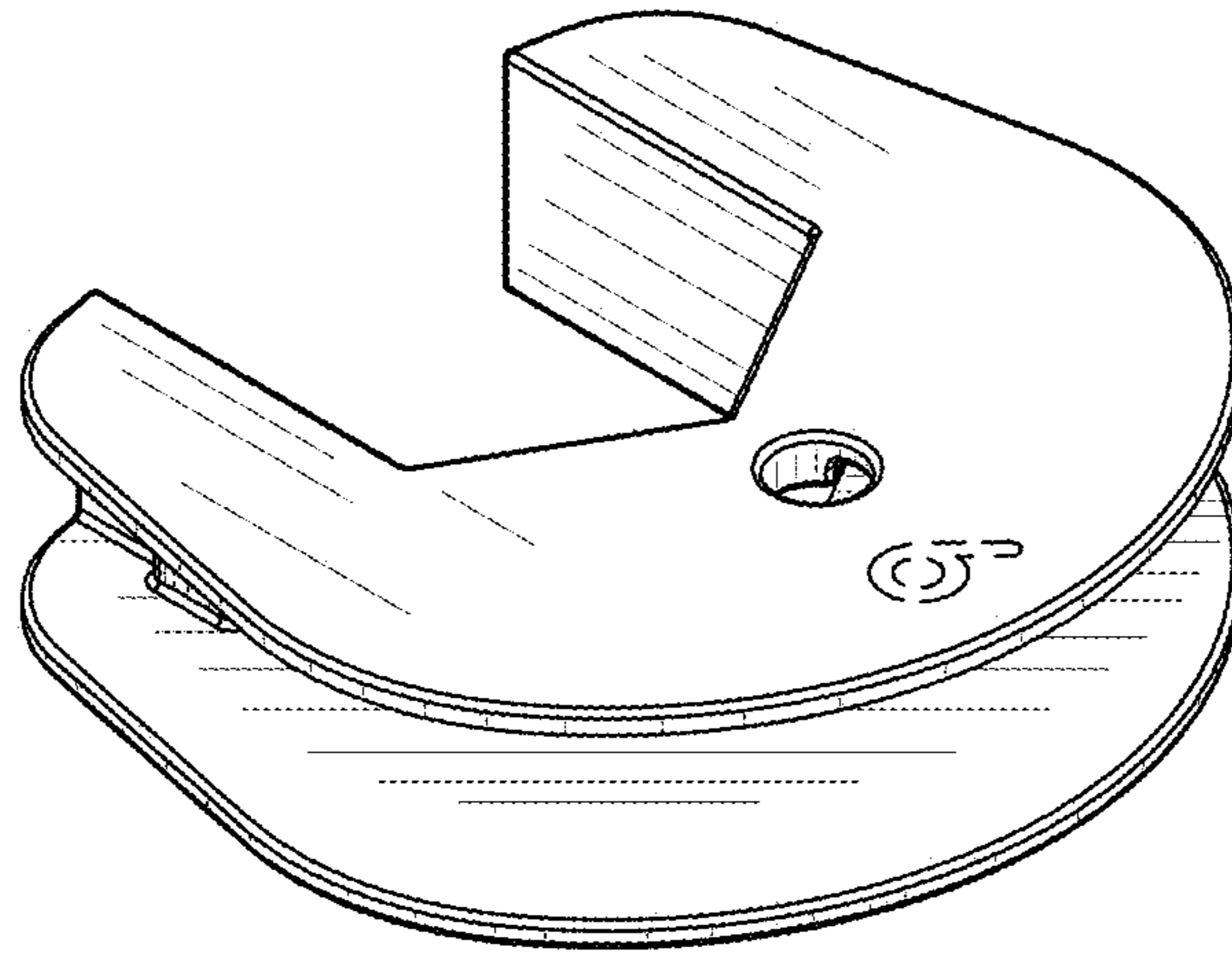

FIG. 19

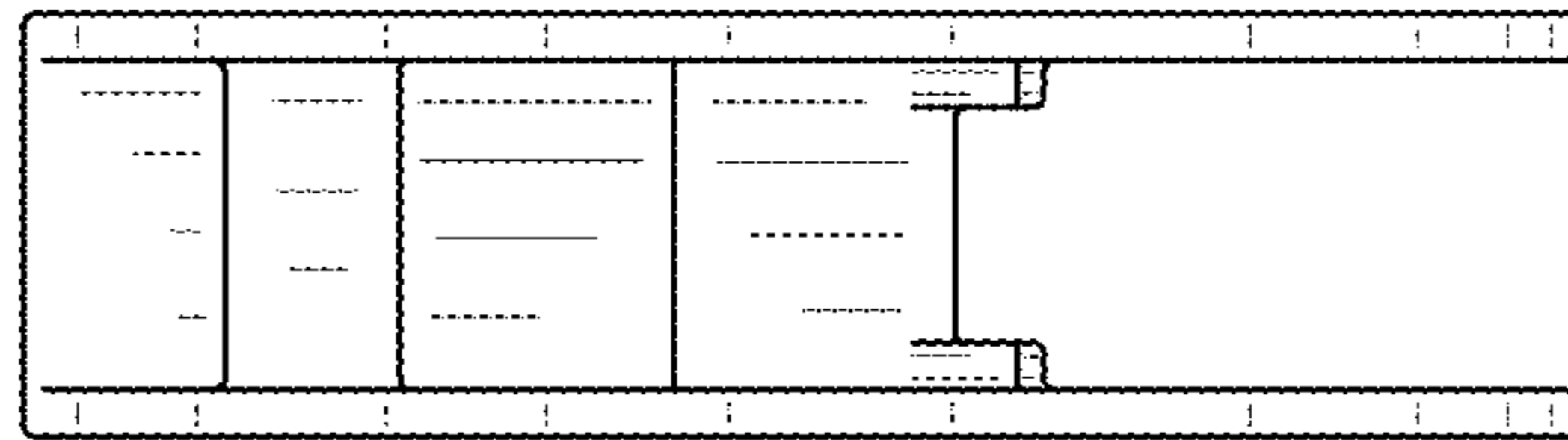

FIG. 20

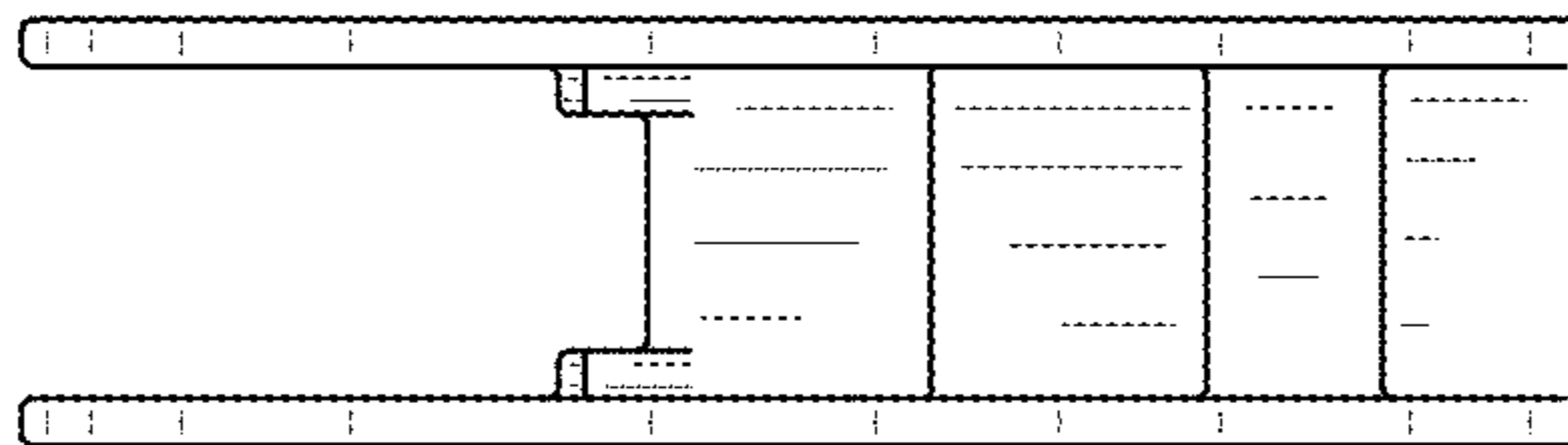

FIG. 21

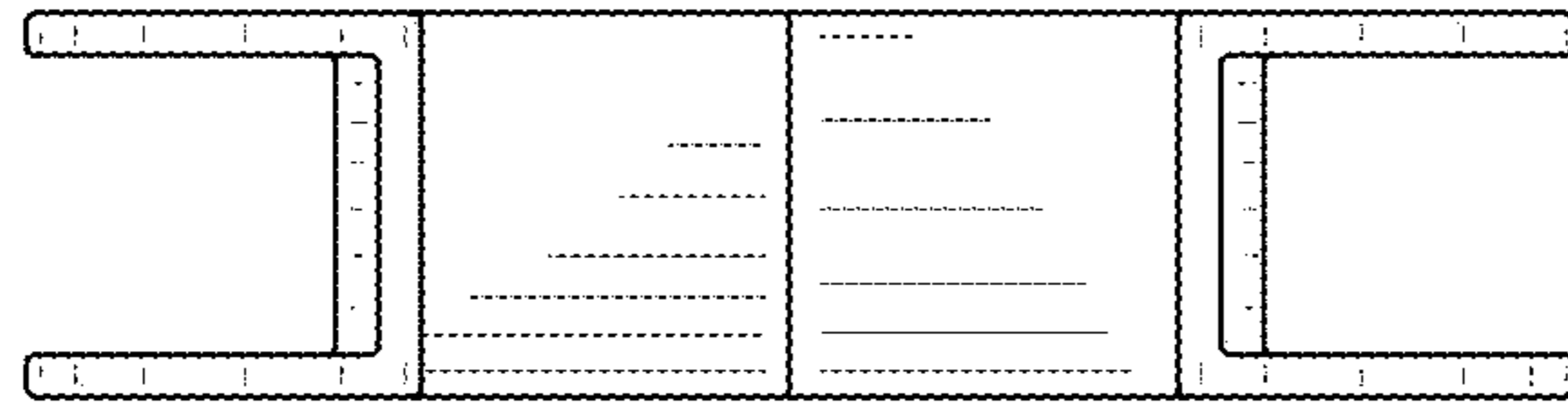

FIG. 22

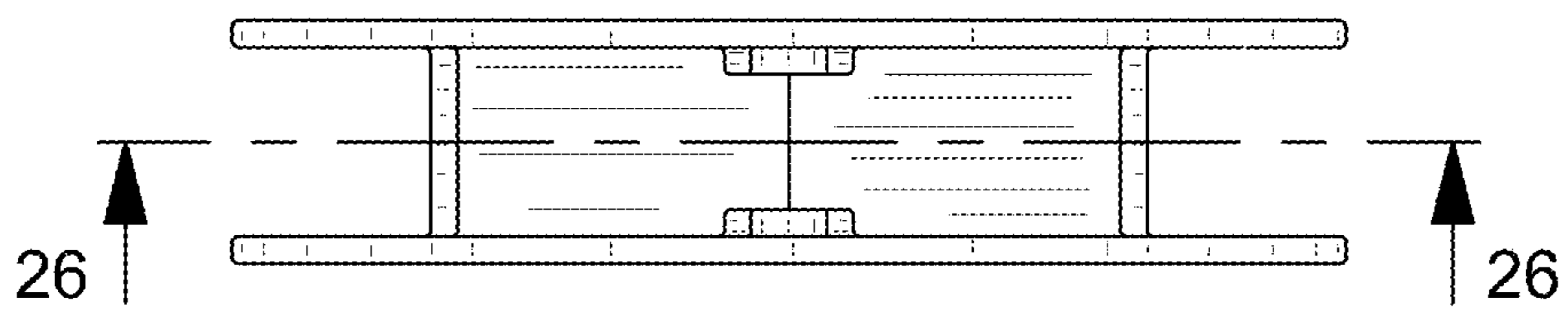

FIG. 23

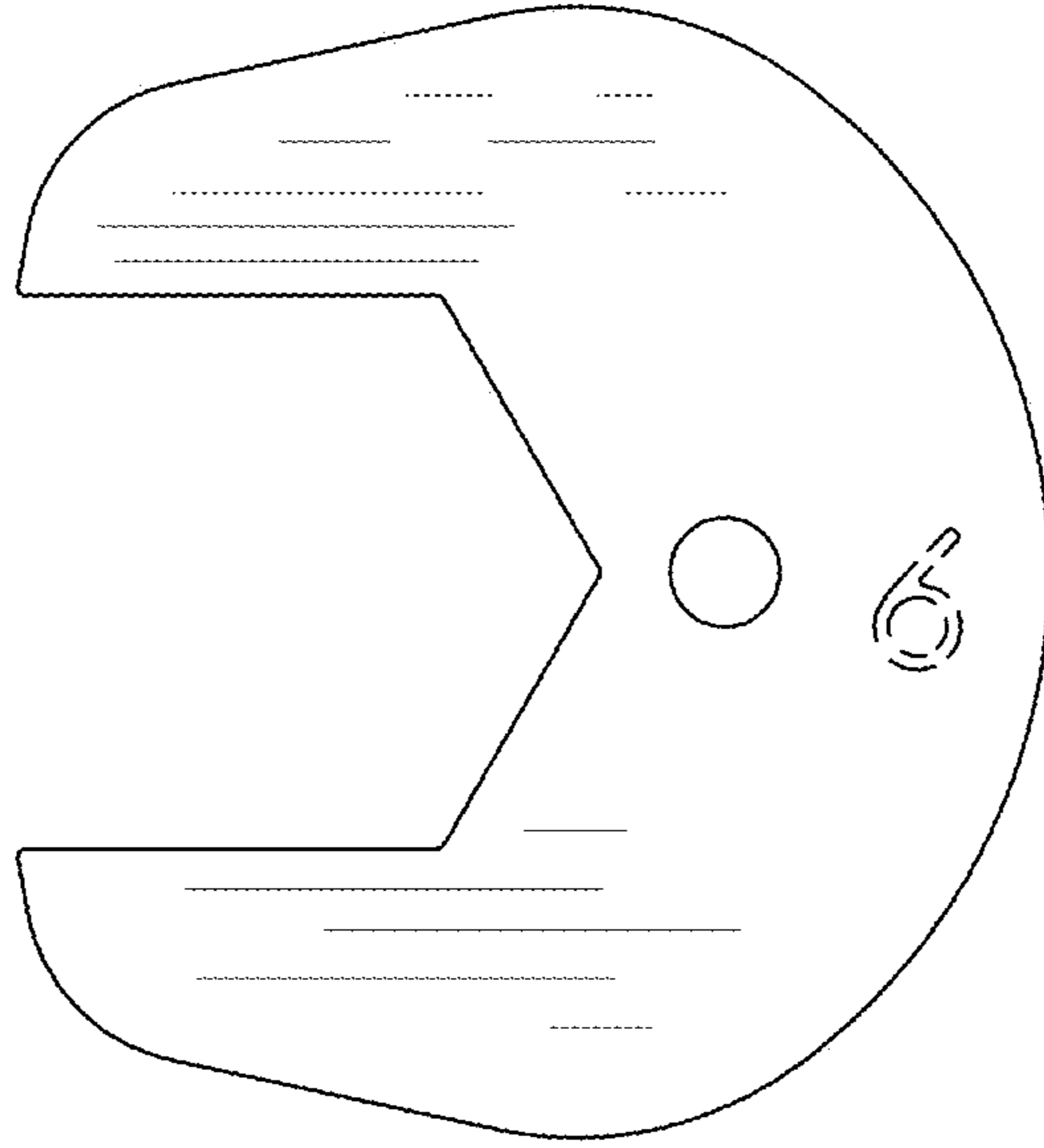

FIG. 24

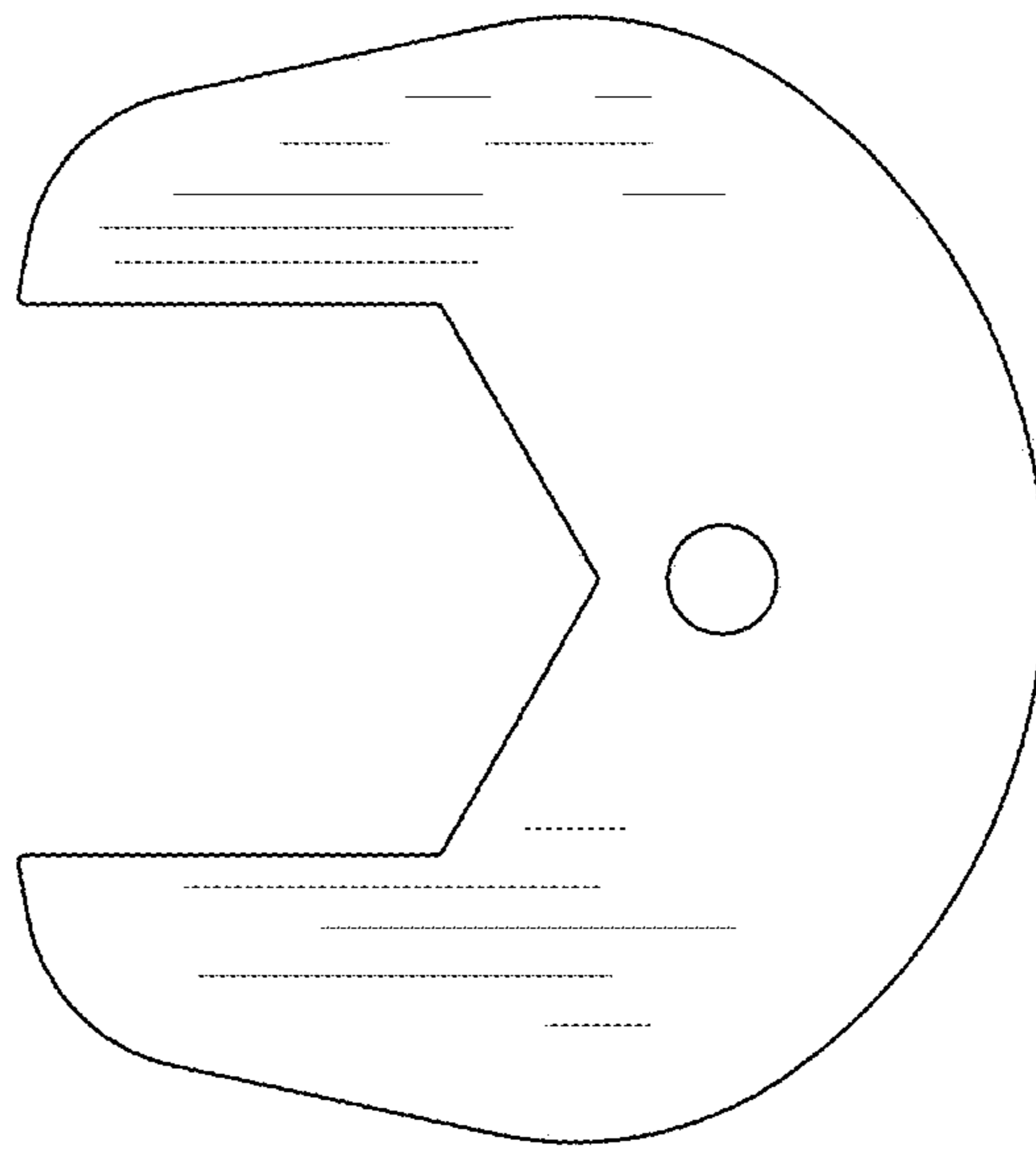

FIG. 25

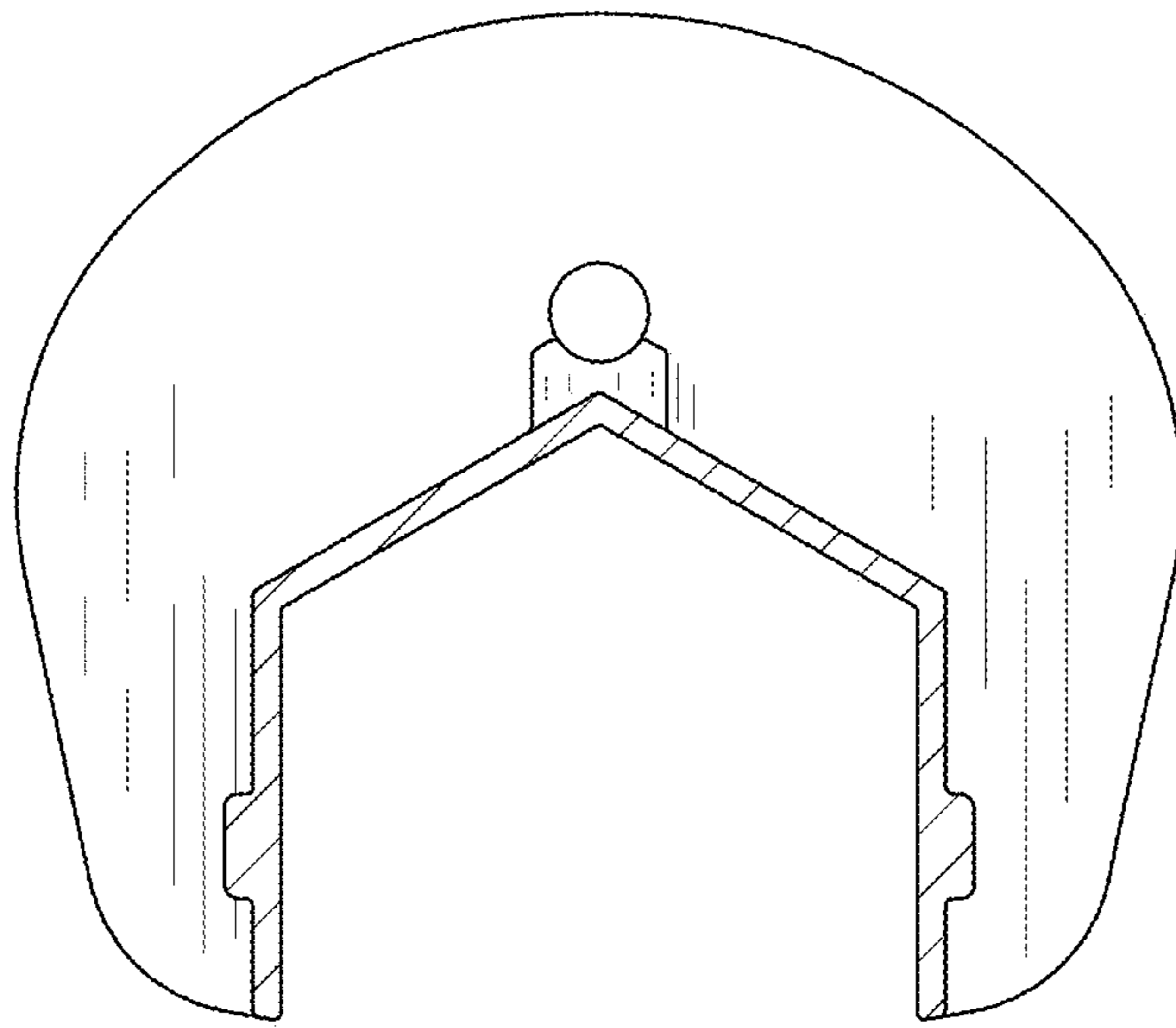

FIG. 26