



US00D939245S

(12) **United States Design Patent**  
**Medina**

(10) **Patent No.:** **US D939,245 S**

(45) **Date of Patent:** **\*\* Dec. 28, 2021**

(54) **PILLOW WITH REMOVABLE INSERTS**

(71) Applicant: **Hector Medina**, Linden, NJ (US)

(72) Inventor: **Hector Medina**, Linden, NJ (US)

(\*\*) Term: **15 Years**

(21) Appl. No.: **29/729,458**

(22) Filed: **Mar. 26, 2020**

(51) **LOC (13) Cl.** ..... **06-09**

(52) **U.S. Cl.**  
USPC ..... **D6/601**

(58) **Field of Classification Search**  
USPC ..... D6/595-601, 604, 611; D21/803, 804;  
D24/183  
CPC ..... A47C 7/12; A47C 7/021; A47C 7/383;  
A47C 7/425; A47C 7/428; A47C 7/546;  
A47C 16/00; A47C 20/00; A47C 20/02;  
A47C 20/021; A47C 20/026; A47C  
20/027; A47C 31/11; A47C 27/001; A47C  
27/081; A47C 1/146; A47G 9/00; A47G  
9/10; A47G 9/07; A47G 9/1027; A47G  
9/1045; A47G 9/1054; A47G 9/1063;  
A47G 9/1072; A47G 9/1081; A47G  
9/109; A47G 2009/1018; A47G  
2009/1036

See application file for complete search history.

(56) **References Cited**

**U.S. PATENT DOCUMENTS**

- 395,043 A \* 12/1888 Doremus ..... A47G 9/10  
5/640
- 1,447,288 A \* 3/1923 Emmerich ..... A47G 9/10  
5/645
- 4,069,526 A \* 1/1978 Deikel ..... A47C 21/022  
5/486
- 4,550,459 A 11/1985 Endel et al.
- 4,853,994 A \* 8/1989 Ekstein ..... A47G 9/1045  
5/639

- 5,572,753 A \* 11/1996 Ruscitto ..... A47G 9/0253  
112/475.08
- 5,664,269 A \* 9/1997 Broder ..... A47G 9/0207  
5/482
- 5,713,089 A \* 2/1998 Ferrante ..... A47G 9/0207  
5/502
- 6,601,252 B1 \* 8/2003 Leach ..... A47C 1/146  
5/420
- D675,855 S \* 2/2013 Reeves ..... D6/601
- 9,032,572 B1 \* 5/2015 Leach ..... A47D 15/003  
5/655
- D777,472 S \* 1/2017 Forman ..... D6/596

(Continued)

*Primary Examiner* — Jennifer L Rempfer

(74) *Attorney, Agent, or Firm* — Walter J. Tencza, Jr.

(57) **CLAIM**

I claim the ornamental design for the pillow with removable inserts, as shown and described.

**DESCRIPTION**

FIG. 1 is a front, top, and left side perspective view of a pillow with removable inserts, wherein the inserts are removed;

FIG. 2 is a front elevational view thereof;

FIG. 3 is a rear elevational view thereof;

FIG. 4 is a left side elevational view thereof;

FIG. 5 is a right side elevational view thereof;

FIG. 6 is a top elevational view thereof;

FIG. 7 is a bottom elevational view thereof;

FIG. 8 is a rear, left, and top perspective view of the pillow with removable inserts wherein the two inserts have been inserted into the pockets;

FIG. 9 is a front elevational view thereof;

FIG. 10 is a rear elevational view thereof;

FIG. 11 is a left side elevational view thereof;

FIG. 12 is a right side elevational view thereof;

FIG. 13 is a top elevational view thereof; and,

FIG. 14 is a bottom elevational view thereof.

The broken lines in the figures illustrate claimed stitching.

**1 Claim, 10 Drawing Sheets**

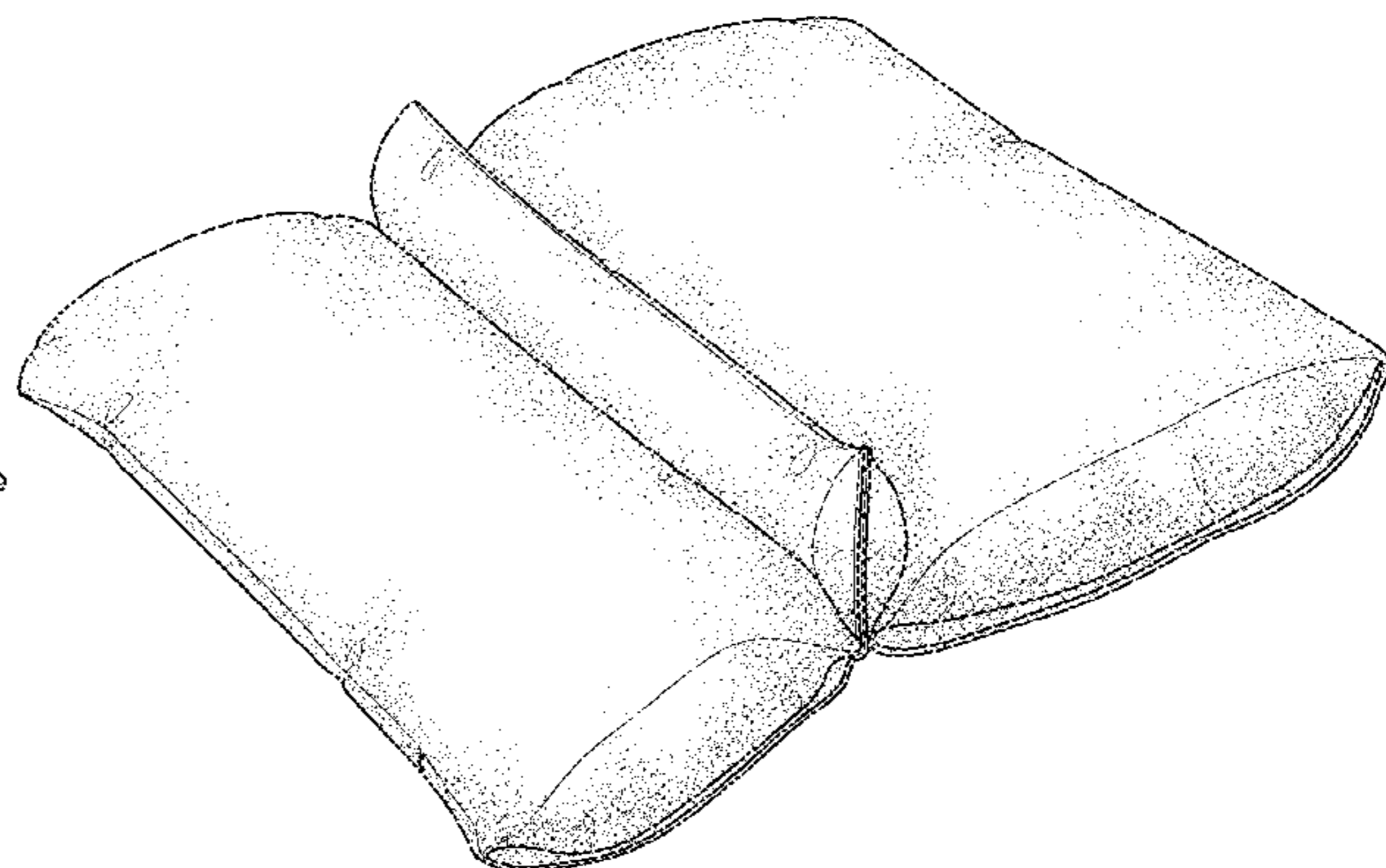
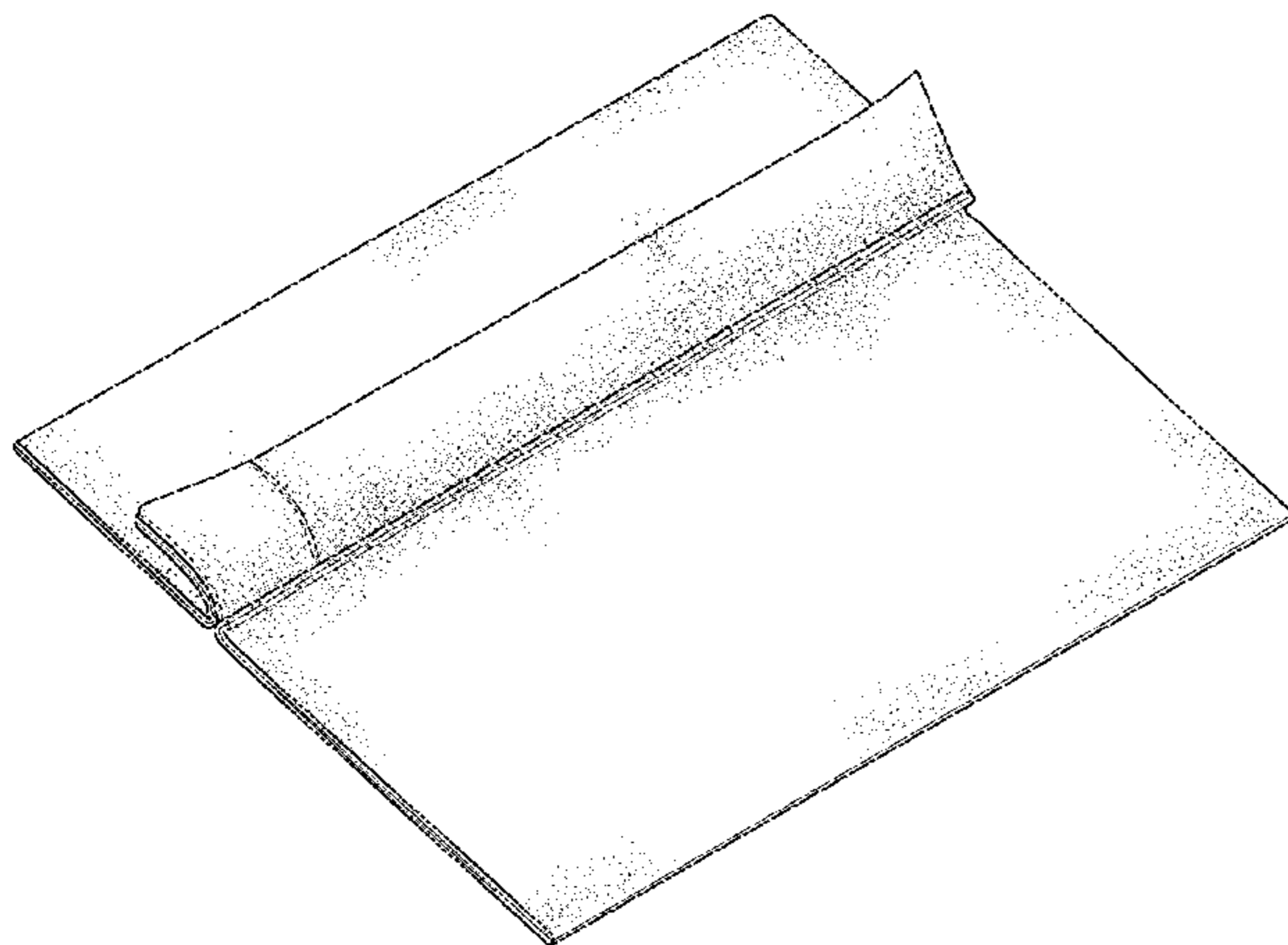

(56)

**References Cited**

U.S. PATENT DOCUMENTS

9,795,232 B2 \* 10/2017 Holbrook ..... A47G 9/1081  
D898,423 S \* 10/2020 Liu ..... D6/601  
2011/0145994 A1 6/2011 Pileggi

\* cited by examiner

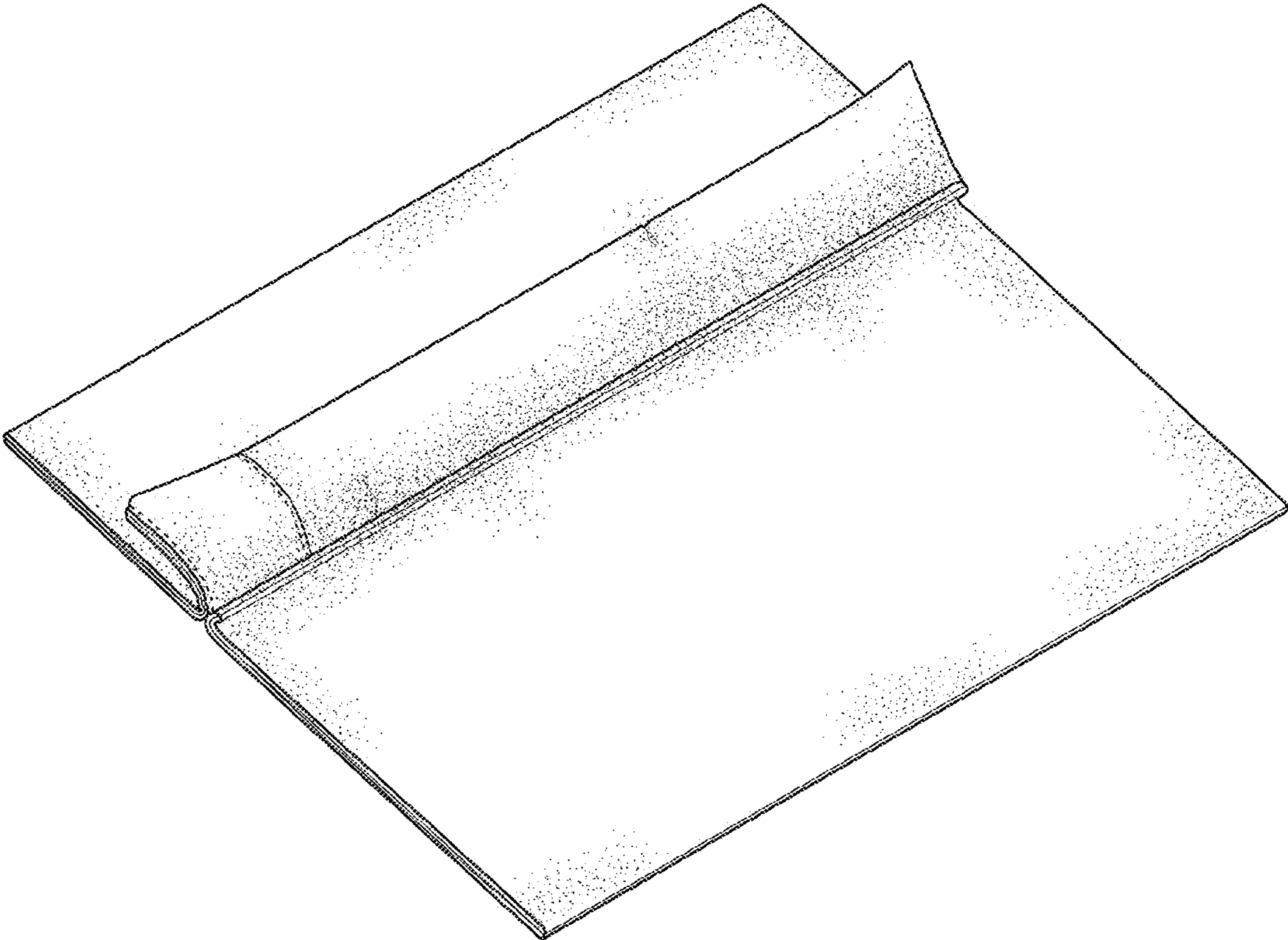

FIG. 1

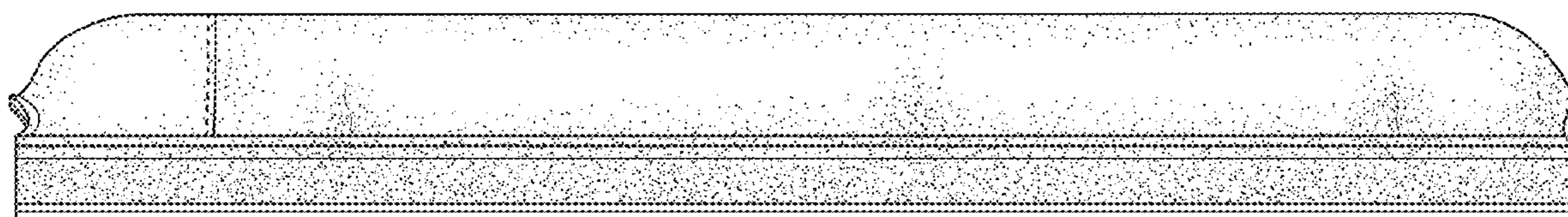

FIG. 2

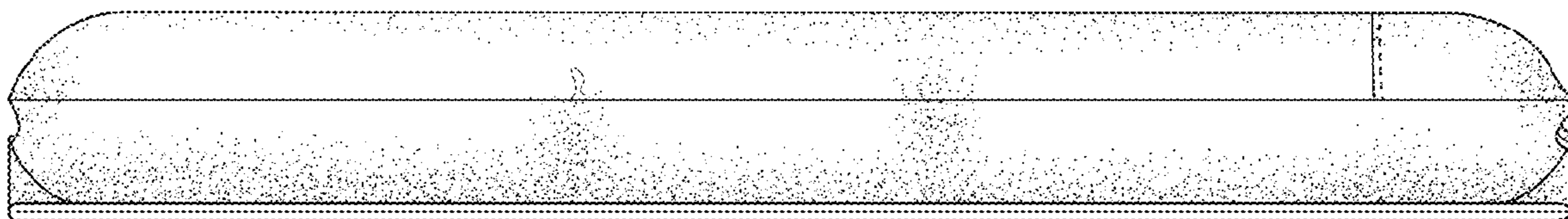

FIG. 3



FIG. 4



FIG. 5

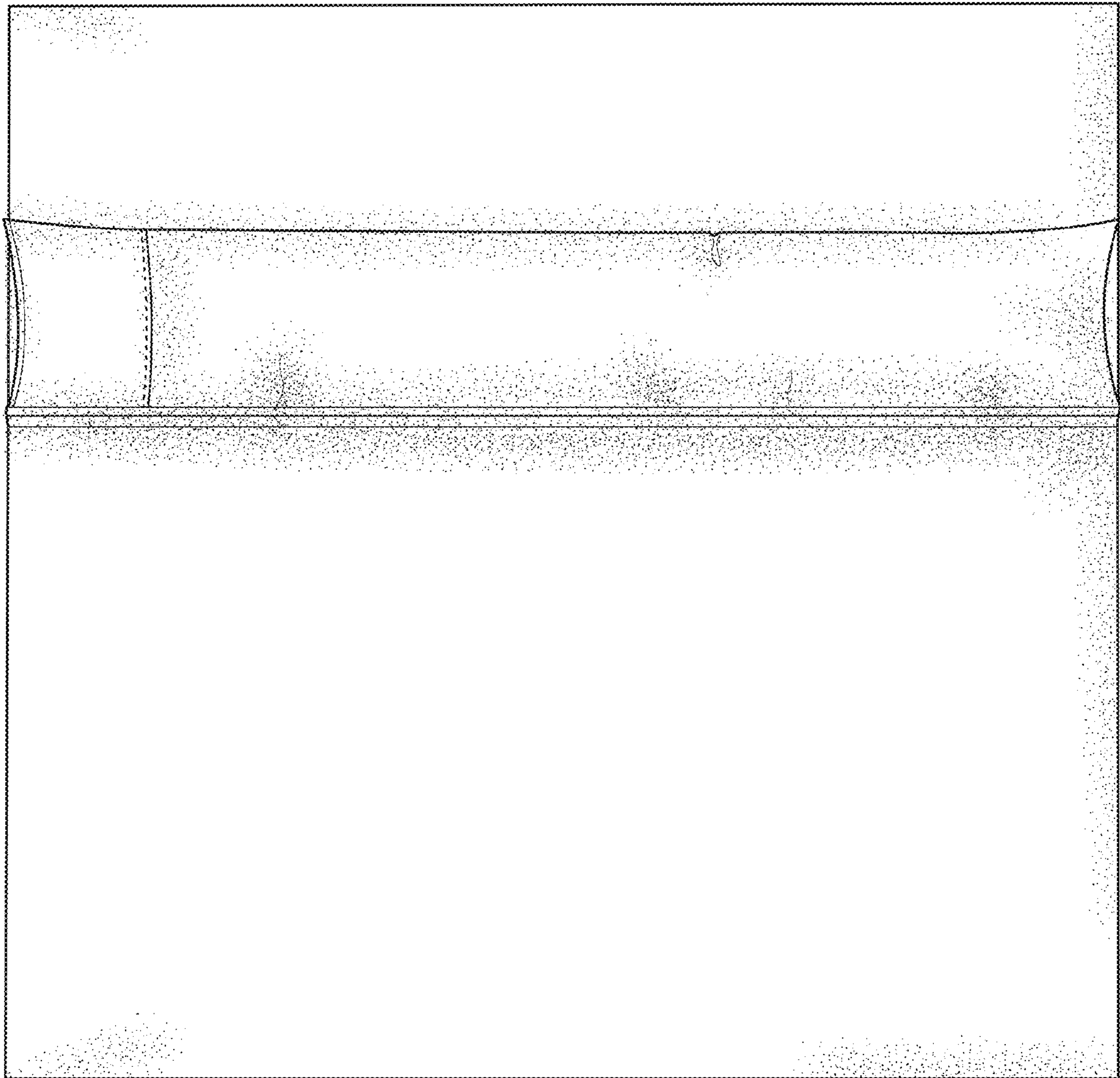

FIG. 6

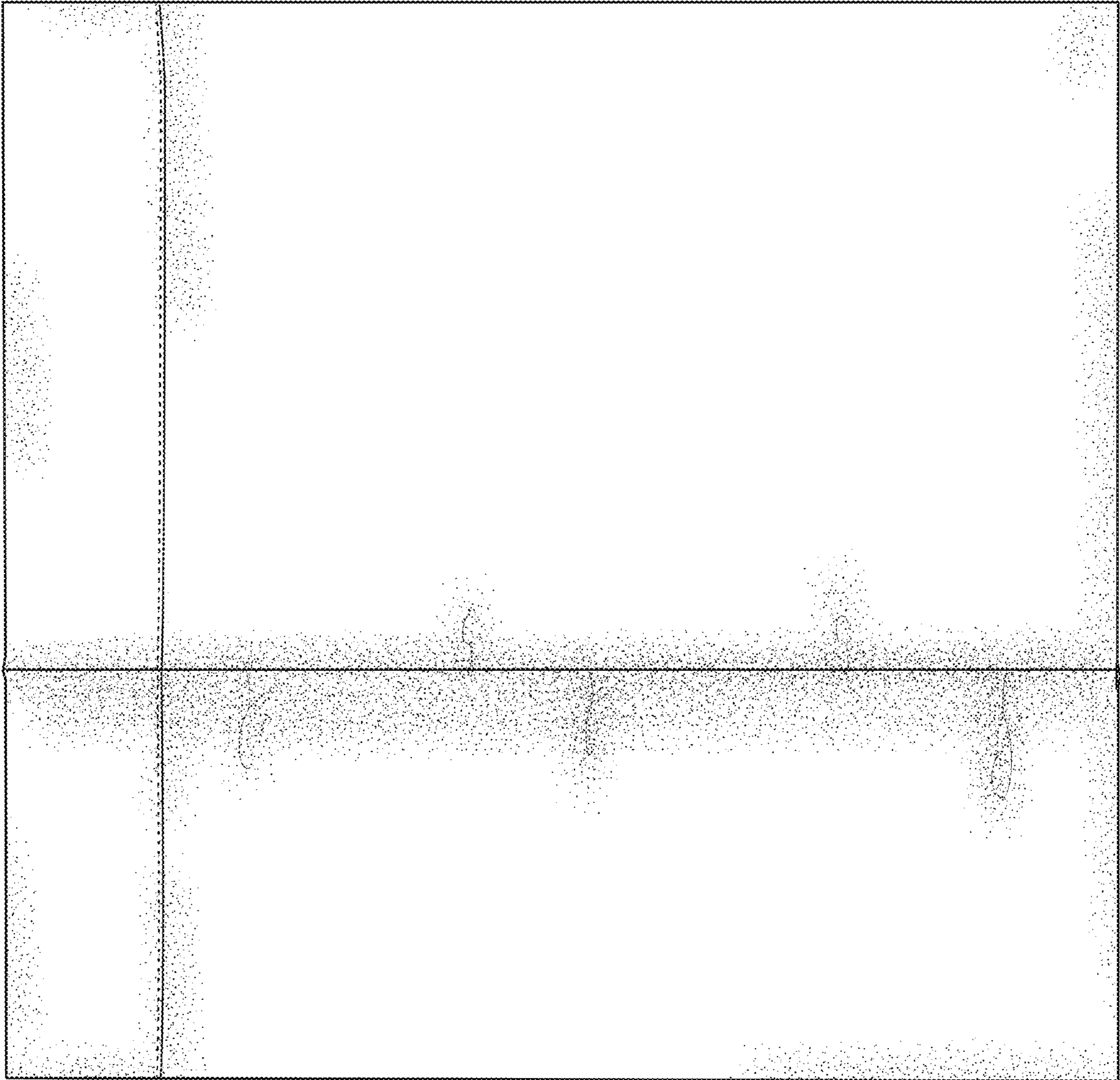

FIG. 7

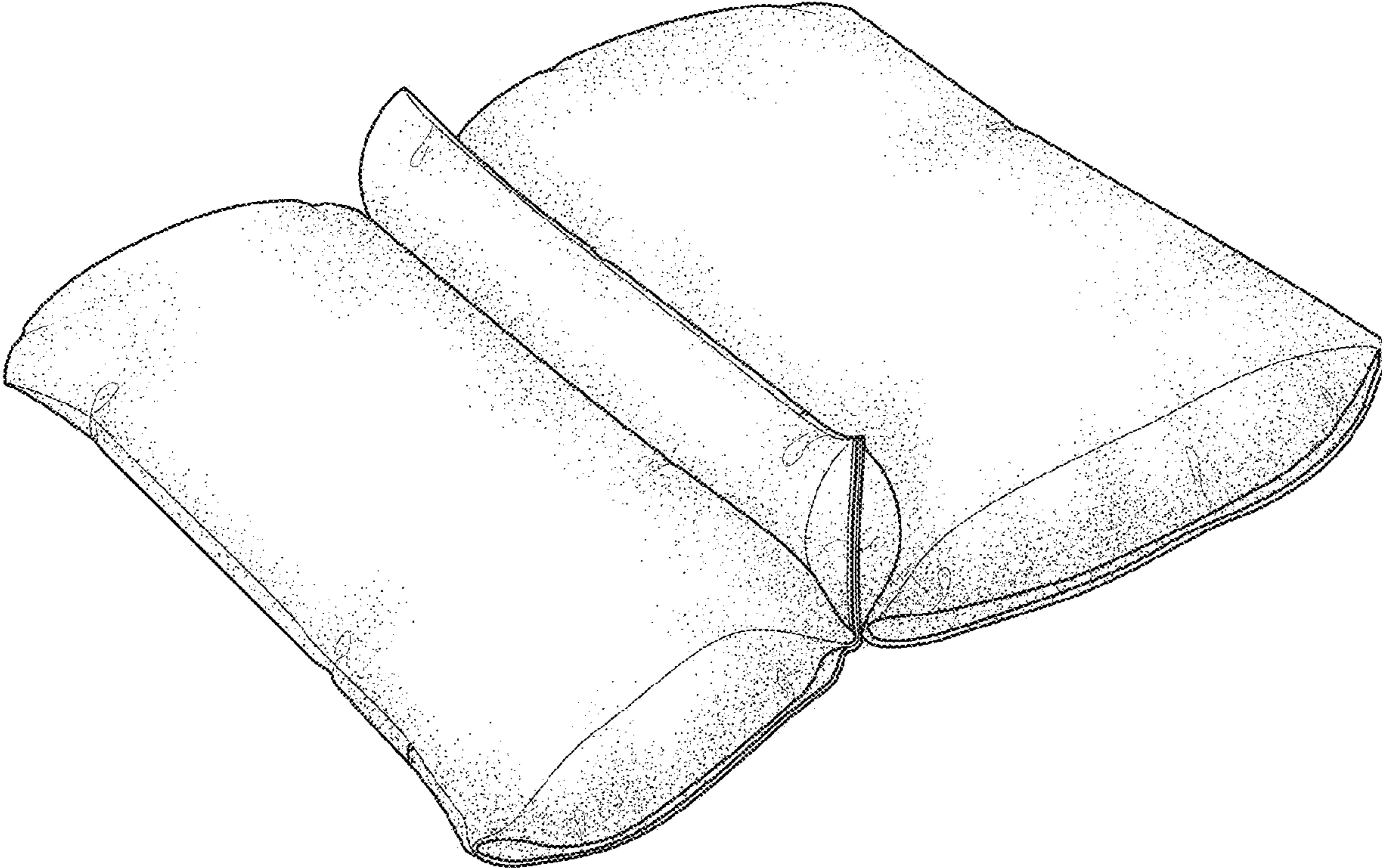

FIG. 8



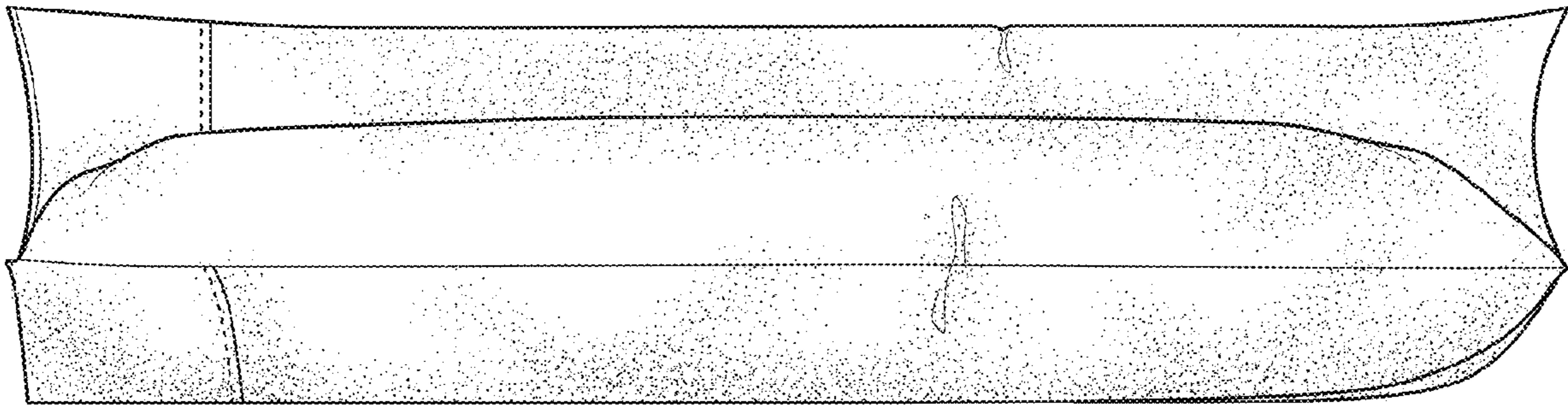

FIG. 9

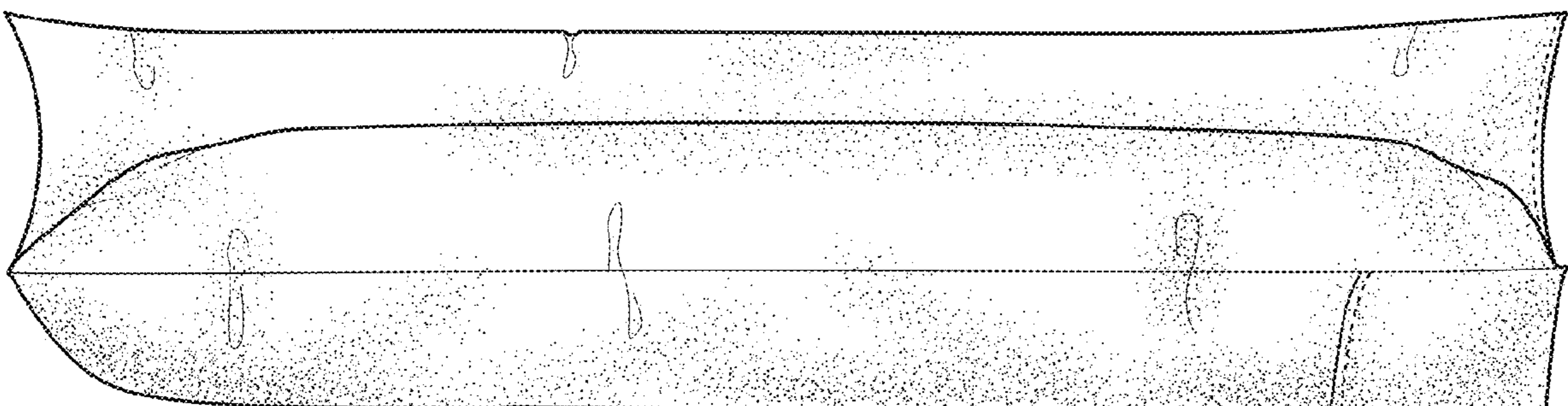

FIG. 10

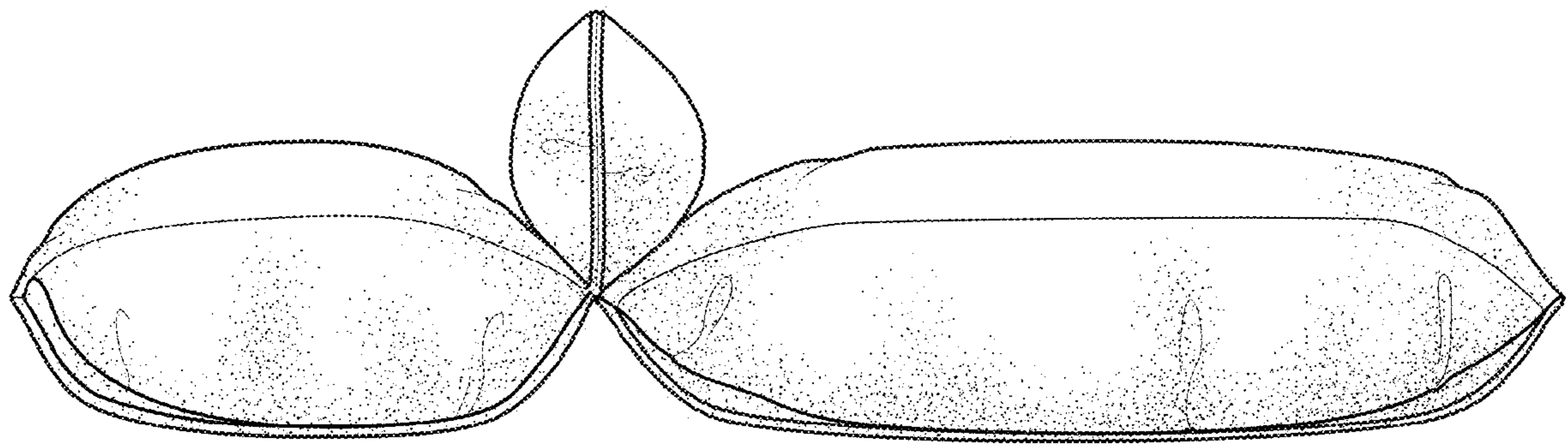

FIG. 11

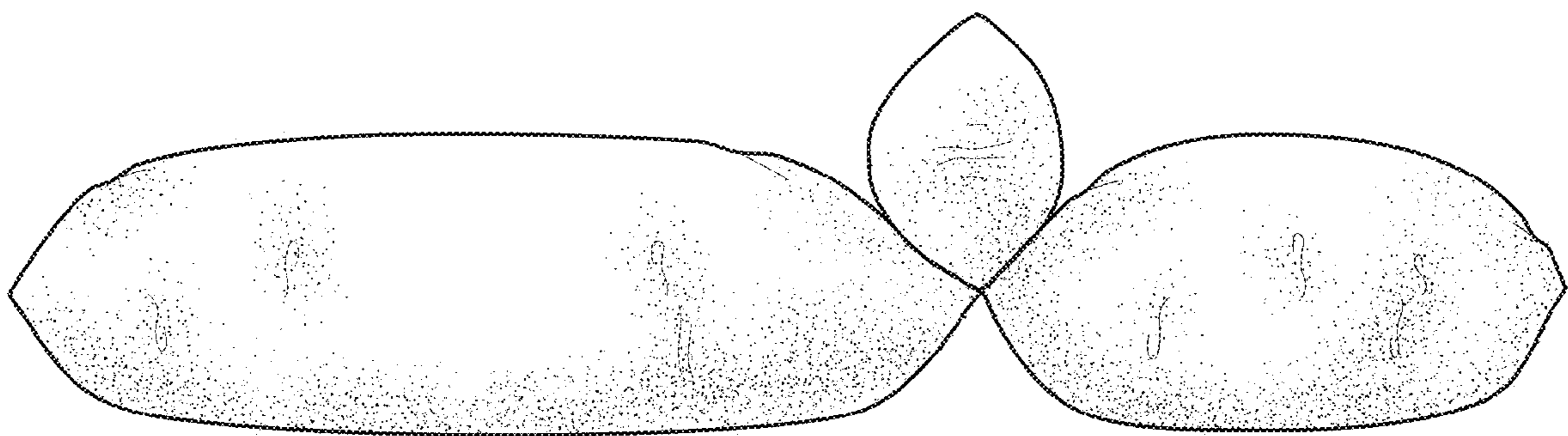

FIG. 12

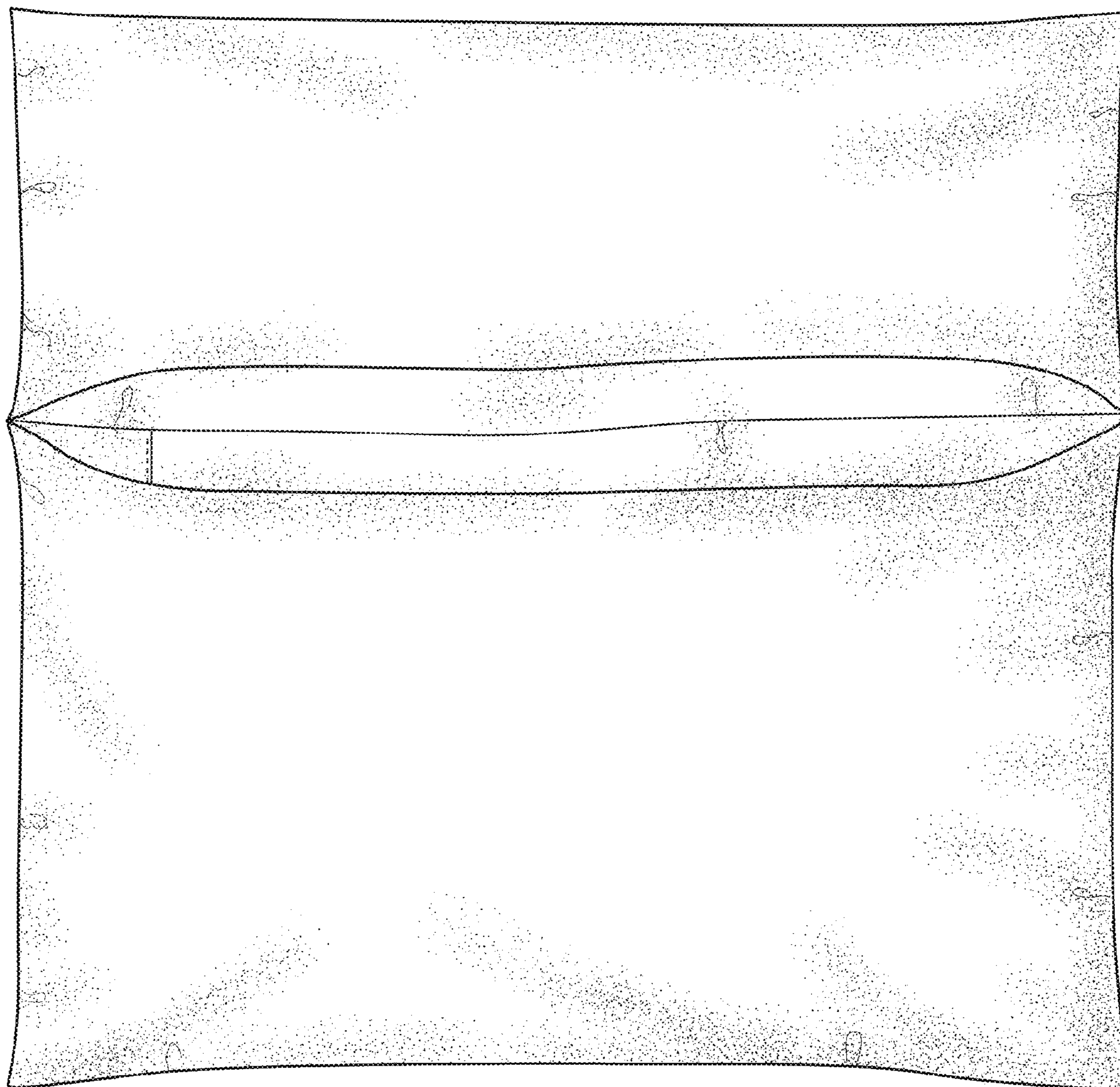

FIG. 13

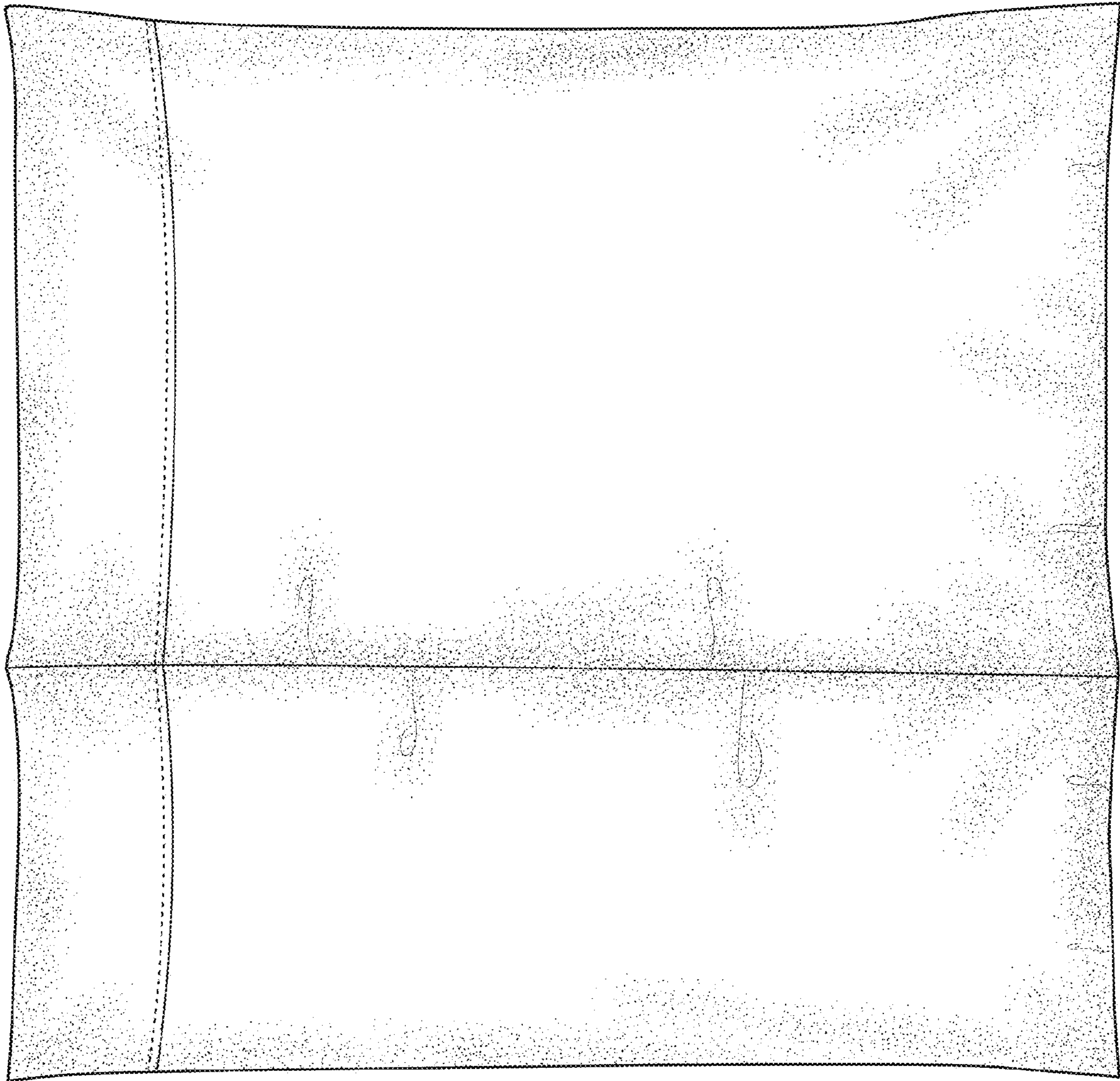

FIG. 14