



US00D939214S

(12) **United States Design Patent** (10) **Patent No.:** **US D939,214 S**  
**Söödi et al.** (45) **Date of Patent:** **\*\* Dec. 28, 2021**

(54) **BASKET**

(71) Applicant: **Dometic Sweden AB**, Solna (SE)

(72) Inventors: **Birk Söödi**, Solna (SE); **Henrik Linder**, Västerås (SE); **Christophe Perez**, Solna (SE); **Samuele Meda**, Chichester (GB)

(73) Assignee: **Dometic Sweden AB**, Solna (SE)

(\*\*) Term: **15 Years**

(21) Appl. No.: **29/743,514**

(22) Filed: **Jul. 22, 2020**

(30) **Foreign Application Priority Data**

Jan. 23, 2020 (EM) ..... 007548805

(51) **LOC (13) Cl.** ..... **03-01**

(52) **U.S. Cl.**  
USPC ..... **D3/308**

(58) **Field of Classification Search**  
USPC ..... D3/304, 307, 308, 310, 313, 315, 328;  
D6/672, 673, 678, 682, 683, 683.1;  
D7/550.1, 552.1, 553.1, 555  
CPC ..... B65D 1/00; B65D 1/22; B65D 2501/24;  
B65D 1/24; B65D 1/34; B65D 1/36  
See application file for complete search history.

(56) **References Cited**

U.S. PATENT DOCUMENTS

2,728,485 A \* 12/1955 Howard ..... B65D 71/0014  
206/200  
3,463,353 A \* 8/1969 Peebles ..... B65D 21/0233  
206/514  
D235,488 S \* 6/1975 Swalm ..... D3/309  
4,098,424 A 7/1978 Liebscher et al.  
D307,967 S \* 5/1990 Lanius ..... D3/309

D327,562 S \* 6/1992 Brightbill ..... D3/308  
D364,039 S \* 11/1995 Kruger ..... D3/315  
D386,616 S \* 11/1997 Nimer ..... D3/308  
D420,221 S \* 2/2000 Williams ..... D3/315  
6,193,247 B1 2/2001 Spear et al.  
D484,011 S \* 12/2003 Strobel ..... D3/309  
D537,251 S \* 2/2007 Musgrove ..... D3/201  
D649,786 S \* 12/2011 Lipfert ..... D3/308  
D688,589 S \* 8/2013 Hung ..... D11/148  
D690,109 S \* 9/2013 Shupp ..... D3/309  
8,544,141 B1 10/2013 Kyde et al.  
8,556,740 B1 10/2013 Schneider  
D704,935 S \* 5/2014 Lintz ..... D3/308

(Continued)

FOREIGN PATENT DOCUMENTS

KR 20120006719 U 10/2012  
WO 9512513 A1 5/1995

OTHER PUBLICATIONS

DE Patent Application No. 102020200825.6 filed on Jan. 23, 2020.

(Continued)

*Primary Examiner* — Kelley A Donnelly

(74) *Attorney, Agent, or Firm* — Middleton Reutlinger

(57) **CLAIM**

The ornamental design of a basket, as shown and described.

**DESCRIPTION**

FIG. 1 is an upper perspective view of a design of a basket; FIG. 2 is a lower perspective view of the design of FIG. 1; FIG. 3 is a front view of the design of FIG. 1; FIG. 4 is a rear view of the design of FIG. 1; FIG. 5 is a first side view of the design of FIG. 1; FIG. 6 is a second side view of the design of FIG. 1; and, FIG. 7 is a top view of the design of FIG. 1.

**1 Claim, 7 Drawing Sheets**

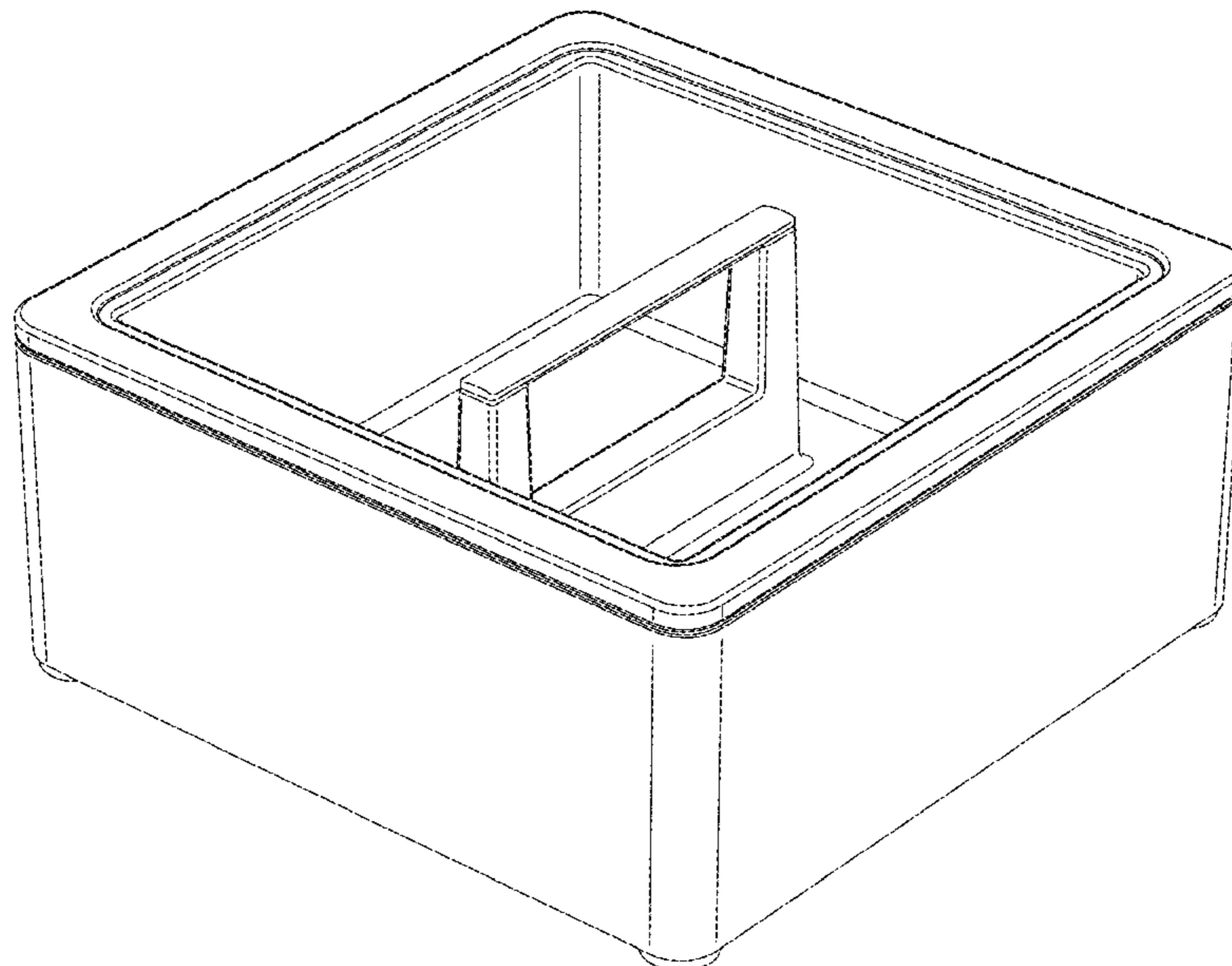

(56)

**References Cited**

## U.S. PATENT DOCUMENTS

D725,910 S \* 4/2015 Sampaio ..... B65D 21/0209  
D3/315  
9,205,951 B1 12/2015 Roman  
D789,690 S \* 6/2017 Foley ..... D3/310  
9,989,299 B1 6/2018 Ballard  
D825,999 S \* 8/2018 Glass ..... D7/600.1  
D838,482 S \* 1/2019 Pistauer ..... D3/304  
D876,835 S \* 3/2020 Libman ..... D3/310  
D880,162 S \* 4/2020 Zemel ..... D3/310  
D895,292 S \* 9/2020 Barness ..... D3/310  
2010/0066045 A1 3/2010 Presnell et al.  
2014/0318156 A1 10/2014 Richardson et al.  
2016/0113395 A1 4/2016 Martell et al.  
2017/0340105 A1 11/2017 Knighton

## OTHER PUBLICATIONS

- DE Patent Application No. 102020200829.9 filed on Jan. 23, 2020.  
DE Patent Application No. 102020200830.2 filed on Jan. 23, 2020.  
DE Patent Application No. 102020200831.0 filed on Jan. 23, 2020.  
EU Design Patent Application No. 007548334-0028 filed on Jan. 23, 2020.  
EU Design Patent Application No. 007548334-0010 filed on Jan. 23, 2020.  
International Search Report Issued in PCT Application No. PCT/EP2021/051207 dated Apr. 13, 2021.  
International Search Report Issued in PCT Application No. PCT/EP2021/051208 dated Apr. 13, 2021.  
International Search Report Issued in PCT Application No. PCT/EP2021/051247 dated Apr. 13, 2021.  
International Search Report Issued in PCT Application No. PCT/EP2021/051249 dated Apr. 13, 2021.  
Notification to Grant Chinese Patent Application No. 202030339270.1 dated Jan. 26, 2021.  
Notification to Grant Chinese Patent Application No. 202030339797.4 dated Nov. 24, 2020.  
Notification to Grant Chinese Patent Application No. 202030339255.7 dated Nov. 24, 2020.  
PCT Patent Application No. PCT/EP2021/051207 entitled "Patio Cooler—Presentation basket Mobar" filed on Jan. 20, 2021.  
PCT Patent Application No. PCT/EP2021/051249 entitled "Patio Cooler—Overall concept Mobar" filed on Jan. 21, 2021.  
PCT Patent Application No. PCT/EP2021/051208 entitled "Patio Cooler—Top plate Mobar" filed on Jan. 20, 2021.  
PCT Patent Application No. PCT/EP2021/051247 entitled "Patio Cooler—Housing Mobar" filed on Jan. 21, 2021.  
U.S. Appl. No. 29/743,513 entitled "Beverage Cart" filed Jul. 22, 2020.  
Australian Patent Application No. 202013740 filed Jul. 9, 2020.  
Australian Patent Application No. 202013761 filed Jul. 9, 2020.  
Australian Patent Application No. 202013767 filed Jul. 9, 2020.  
Australian Patent Application No. 202013729 filed Jul. 9, 2020.  
Australian Patent Application No. 202013764 filed Jul. 9, 2020.  
Australian Patent Application No. 202013728 filed Jul. 9, 2020.  
Australian Patent Application No. 202013756 filed Jul. 9, 2020.  
Australian Patent Application No. 202013721 filed Jul. 9, 2020.  
Australian Patent Application No. 202013725 filed Jul. 9, 2020.  
Australian Patent Application No. 202013723 filed Jul. 9, 2020.  
Australian Patent Application No. 202013768 filed Jul. 9, 2020.  
Australian Patent Application No. 202013758 filed Jul. 9, 2020.  
Chinese Patent Application No. 202030338770.3 filed Jun. 29, 2020.  
Chinese Patent Application No. 202030339270.1 filed Jun. 29, 2020.  
Chinese Patent Application No. 202030339255.7 filed Jun. 29, 2020.  
Chinese Patent Application No. 202030339797.4 filed Jun. 29, 2020.  
EU Design Patent Application No. 007548334-0018 filed on Jan. 23, 2020.  
Examination Report received in EU Design Patent Application No. 007548334-0001-30 dated Feb. 28, 2020.  
Examination Report received in EU Design Patent Application No. 007548334-0001-30 dated Jan. 30, 2020.  
EU Design Patent Application No. 007548334-0002 filed on Jan. 23, 2020.  
EU Design Patent Application No. 007548334-0017 filed on Jan. 23, 2020.  
EU Design Patent Application No. 007548334-0016 filed on Jan. 23, 2020.  
EU Design Patent Application No. 007548334-0014 filed on Jan. 23, 2020.  
EU Design Patent Application No. 007548334-0003 filed on Jan. 23, 2020.  
EU Design Patent Application No. 007548334-0019 filed on Jan. 23, 2020.  
EU Design Patent Application No. 007548805-0004 filed on Jan. 23, 2020.  
EU Design Patent Application No. 007548334-0012 filed on Jan. 23, 2020.  
EU Design Patent Application No. 007548334-0011 filed on Jan. 23, 2020.  
EU Design Patent Application No. 007548334-0009 filed on Jan. 23, 2020.  
EU Design Patent Application No. 007548334-0021 filed on Jan. 23, 2020.  
EU Design Patent Application No. 007548805-0002 filed on Jan. 23, 2020.  
EU Design Patent Application No. 007548805-0003 filed on Jan. 23, 2020.  
EU Design Patent Application No. 007548334-0008 filed on Jan. 23, 2020.  
EU Design Patent Application No. 007548334-0029 filed on Jan. 23, 2020.  
EU Design Patent Application No. 007548334-0005 filed on Jan. 23, 2020.  
EU Design Patent Application No. 007548334-0013 filed on Jan. 23, 2020.  
EU Design Patent Application No. 007548334-0024 filed on Jan. 23, 2020.  
EU Design Patent Application No. 007548334-0001 filed on Jan. 23, 2020.  
EU Design Patent Application No. 007548334-0006 filed on Jan. 23, 2020.  
EU Design Patent Application No. 007548334-0025 filed on Jan. 23, 2020.  
EU Design Patent Application No. 007548334-0023 filed on Jan. 23, 2020.  
EU Design Patent Application No. 007548334-0015 filed on Jan. 23, 2020.  
EU Design Patent Application No. 007548334-0026 filed on Jan. 23, 2020.  
EU Design Patent Application No. 007548334-0030 filed on Jan. 23, 2020.  
EU Design Patent Application No. 007548334-0022 filed on Jan. 23, 2020.  
EU Design Patent Application No. 007548334-0007 filed on Jan. 23, 2020.  
EU Design Patent Application No. 007548334-0004 filed on Jan. 23, 2020.  
EU Design Patent Application No. 007548805-0001 filed on Jan. 23, 2020.  
EU Design Patent Application No. 007548334-0020 filed on Jan. 23, 2020.  
EU Design Patent Application No. 007548334-0027 filed on Jan. 23, 2020.  
United Kingdom Design Application No. 6157124 titled "Presentation basket" filed on Aug. 26, 2021.

(56)

**References Cited**

OTHER PUBLICATIONS

United Kingdom Design Application No. 6157125 titled "Presentation basket" filed on Aug. 26, 2021.

\* cited by examiner

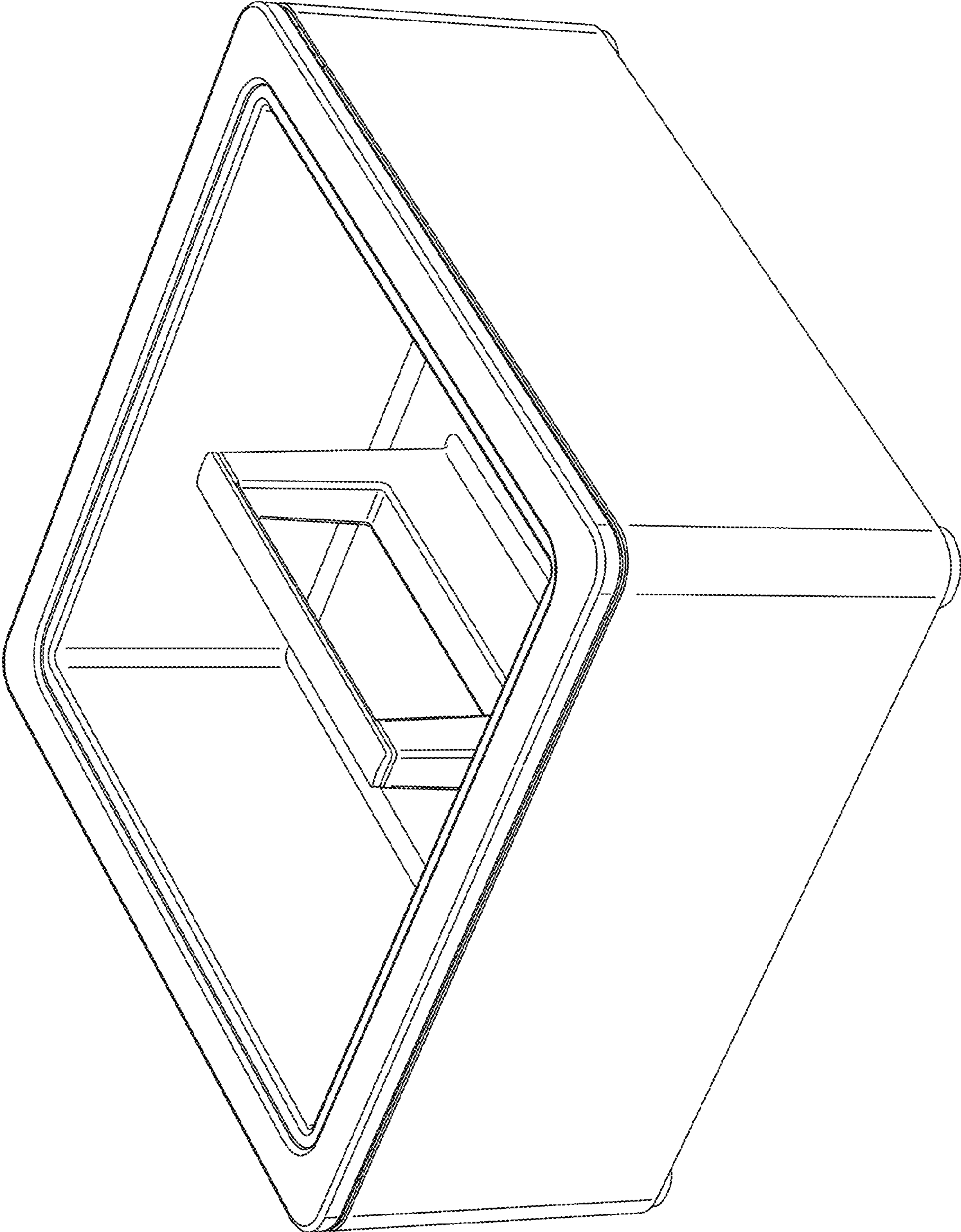

FIG. 1

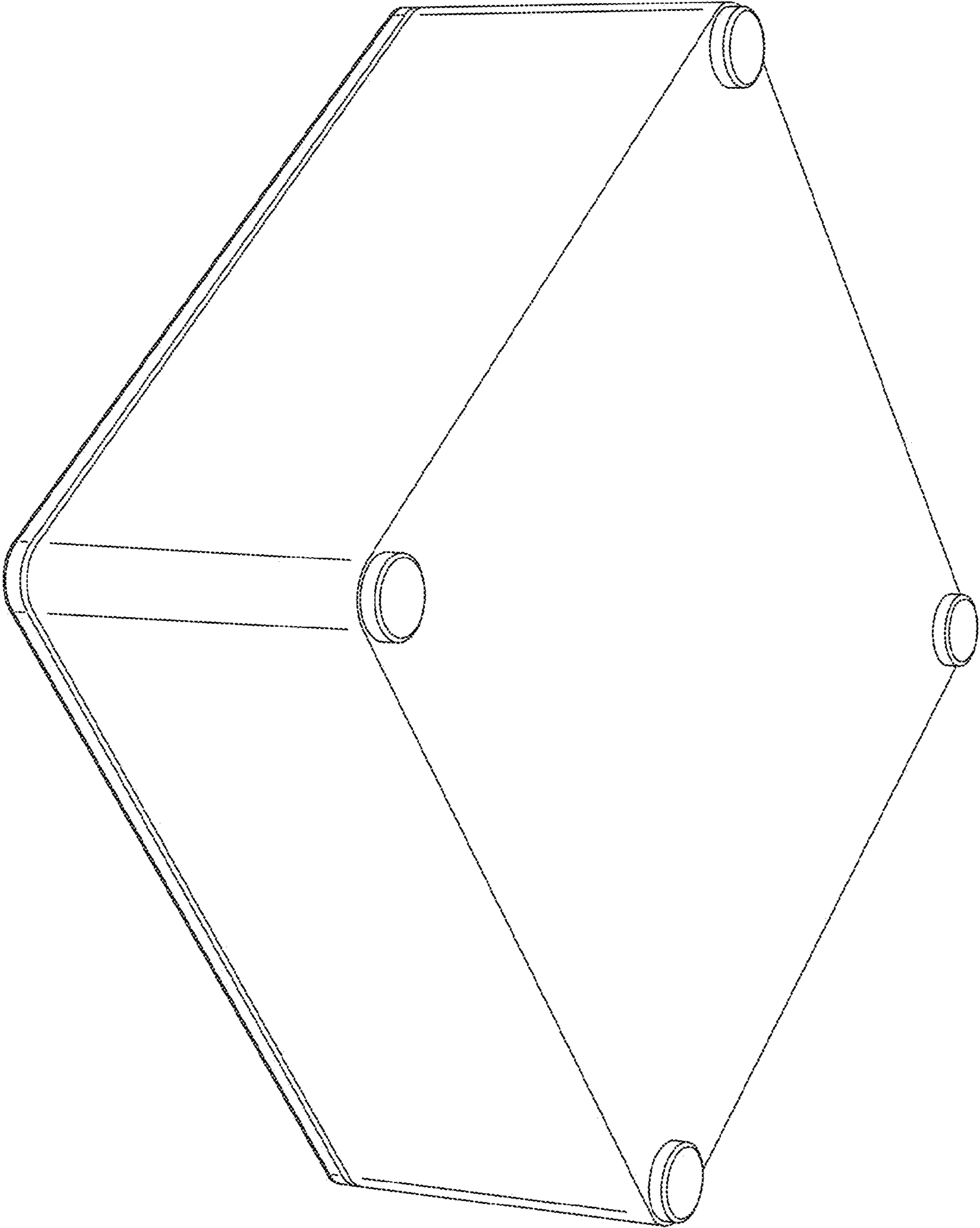

FIG. 2

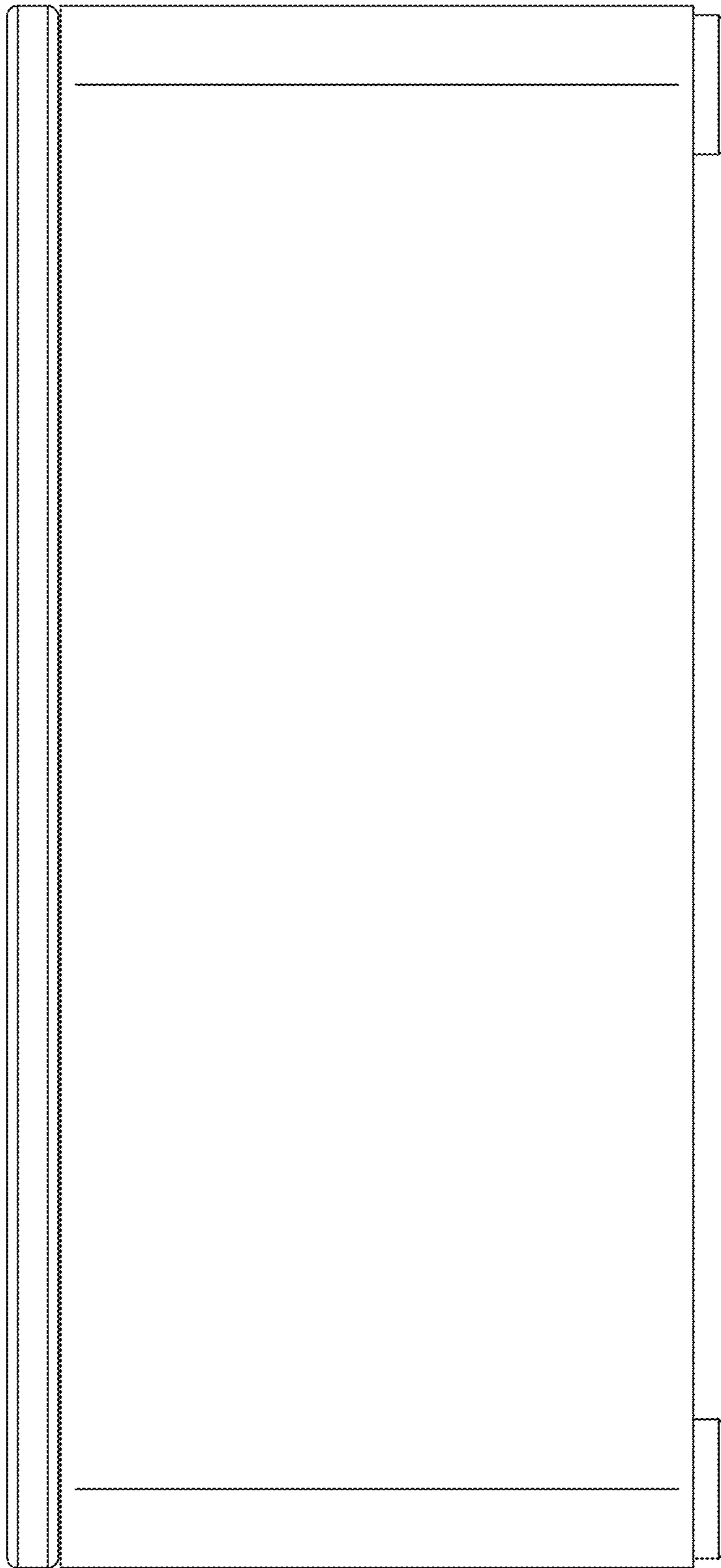

FIG. 3

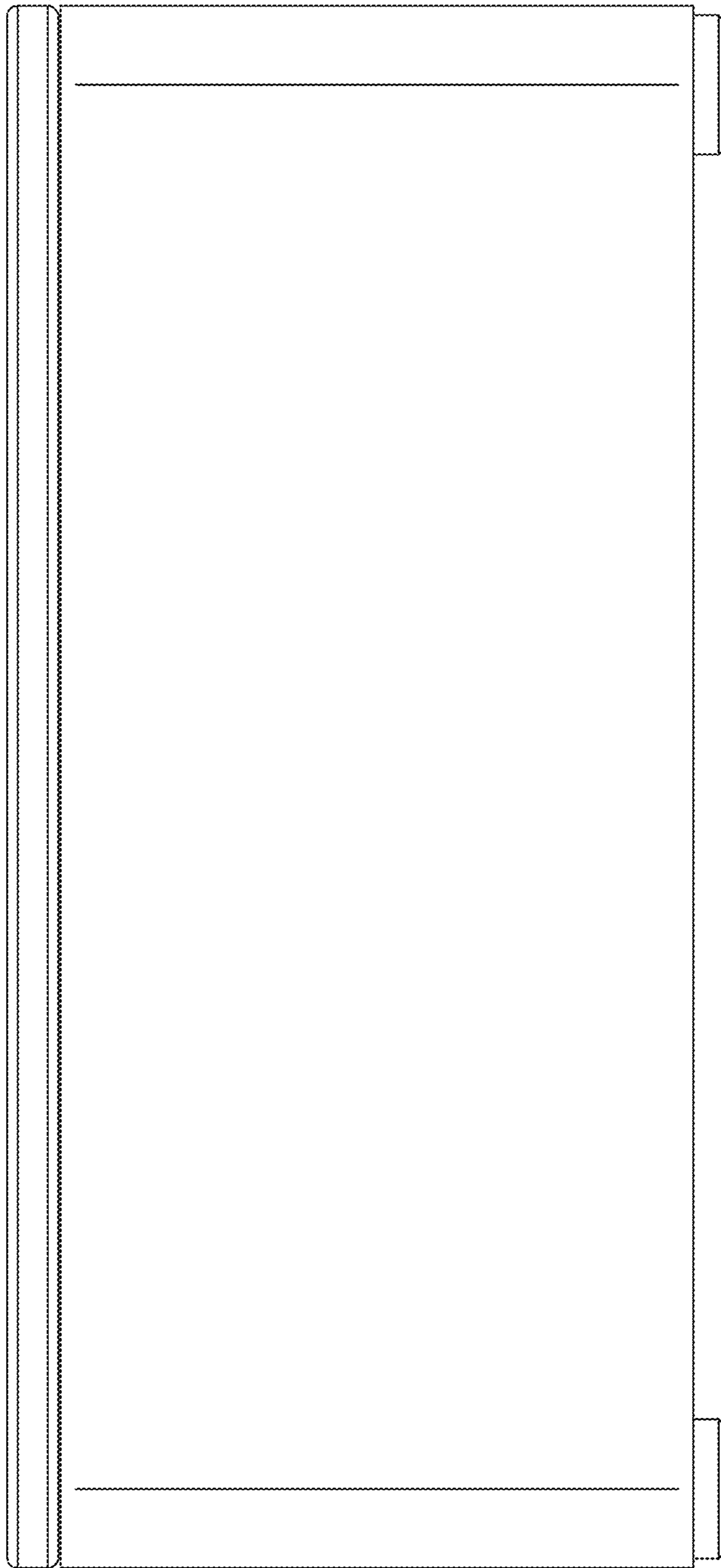

FIG. 4

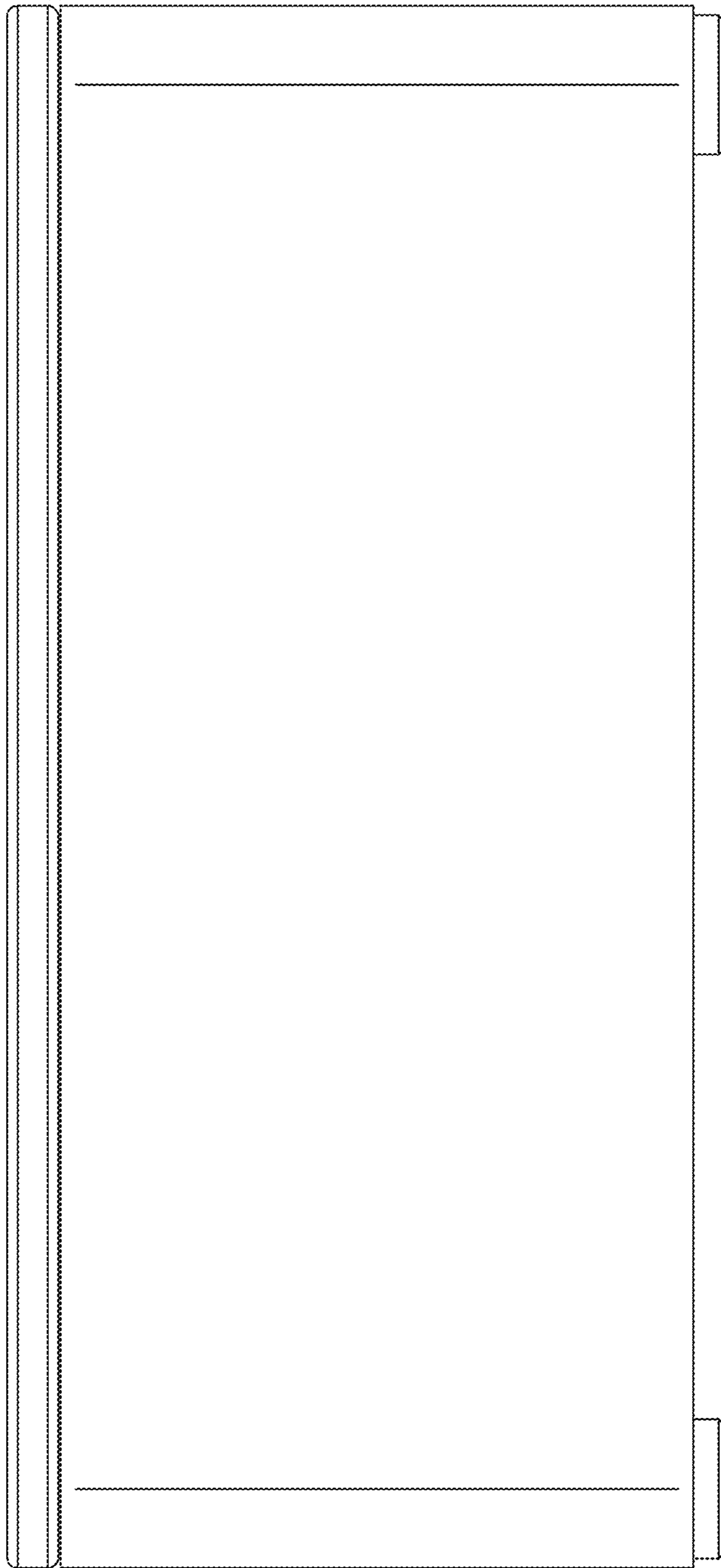

FIG. 5



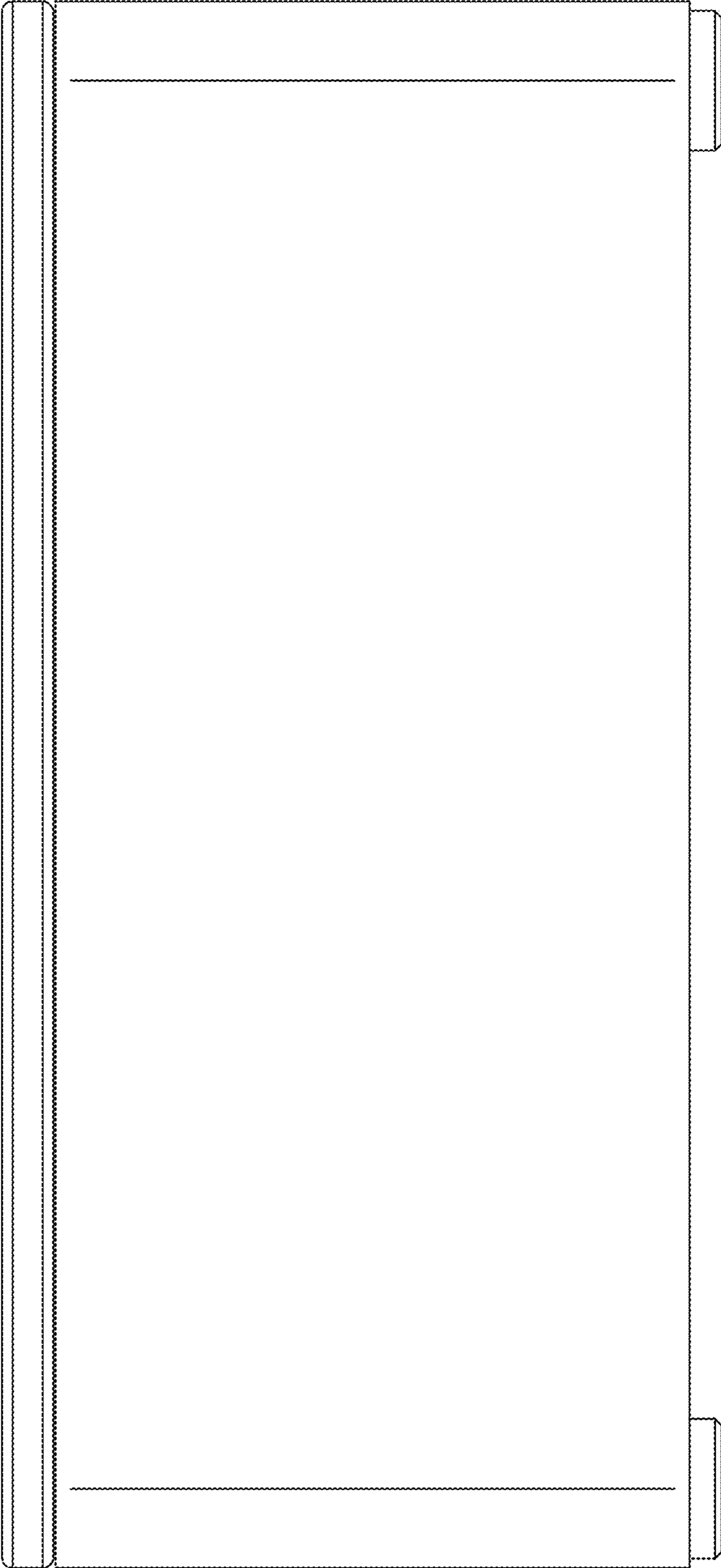

FIG. 6

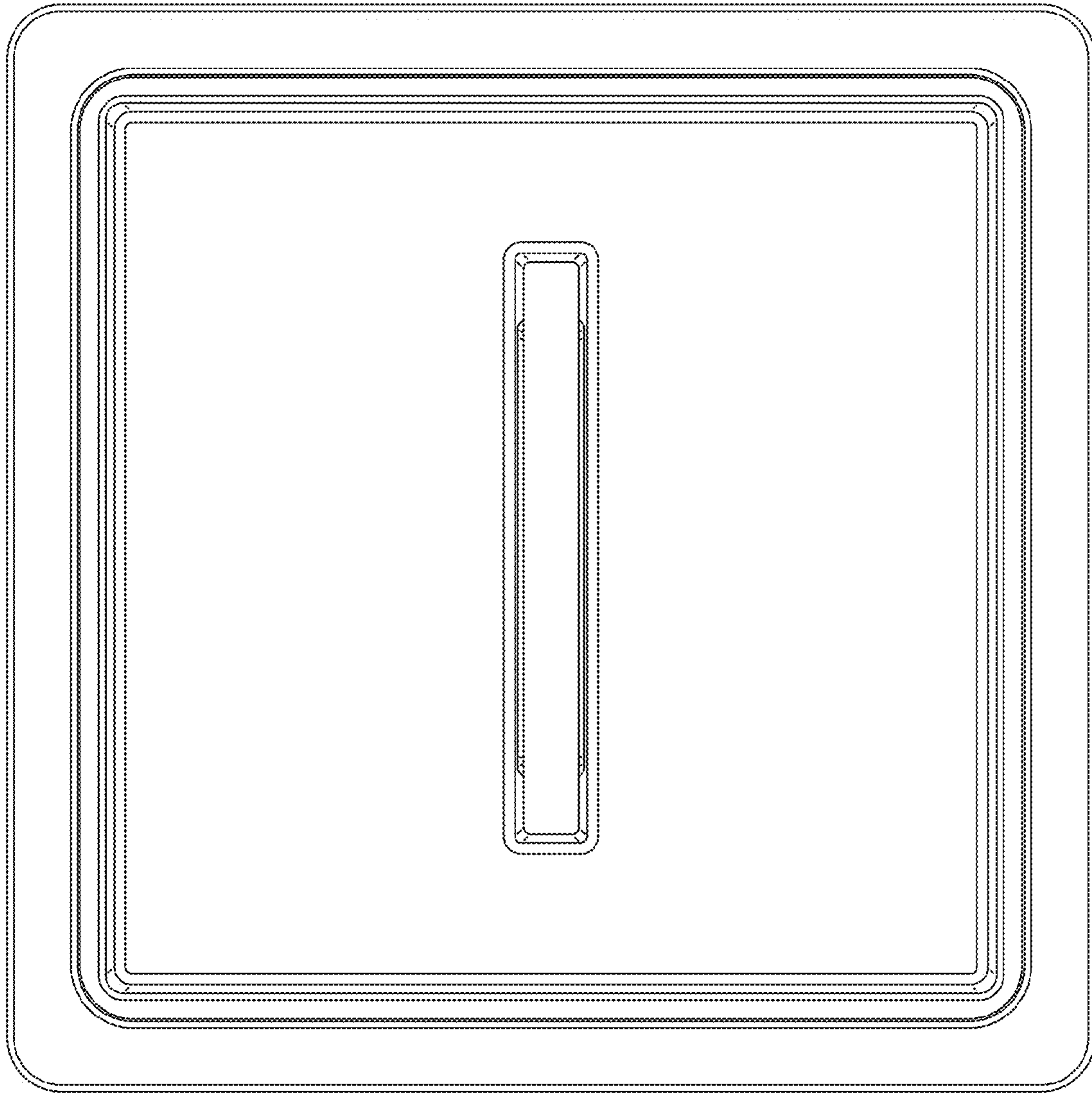

FIG. 7