



US00D939189S

(12) **United States Design Patent** (10) **Patent No.:** **US D939,189 S**  
**De Mulder** (45) **Date of Patent:** **\*\* Dec. 28, 2021**

(54) **EXERCISE SHORTS**

(74) *Attorney, Agent, or Firm* — William Mansfield

(71) Applicant: **Oona De Mulder**, Natick, MA (US)

(57) **CLAIM**

(72) Inventor: **Oona De Mulder**, Natick, MA (US)

I claim the ornamental design for exercise shorts, as shown and described.

(\*\*) Term: **15 Years**

**DESCRIPTION**

(21) Appl. No.: **29/755,409**

(22) Filed: **Oct. 20, 2020**

(51) **LOC (13) Cl.** ..... **02-02**

(52) **U.S. Cl.**  
USPC ..... **D2/738**

(58) **Field of Classification Search**  
USPC ..... D2/738, 731, 728, 700, 712-713, 716,  
D2/853, 857  
CPC .. A41B 9/00; A41B 9/02; A41B 9/023; A41B  
9/001; A41D 1/06; A41D 27/20; A41D  
27/201; A41D 27/205  
See application file for complete search history.

Cross-Reference to Earlier Utility patent application Ser. No. 10/437,157.  
FIG. 1 is a front view, showing the exercise shorts in a configuration.  
FIG. 2 is a back view thereof.  
FIG. 3 is a right-side view thereof with phone pocket.  
FIG. 4 is a left-side view thereof with bottle pocket.  
FIG. 5 is a front view, showing the crotch area of the exercise shorts open.  
FIG. 6 is a back view, showing the crotch area of the exercise shorts open.  
FIG. 7 is another front view, showing the crotch area of the exercise shorts being shown in use.  
FIG. 8 is an enlarged right-side view of a phone side pocket of the exercise shorts.  
FIG. 9 is an enlarged right-side view of a phone side pocket of the exercise shorts being shown in use.  
FIG. 10 is an enlarged left-side view of a bottle side pocket with pleat of the exercise shorts.  
FIG. 11 is an enlarged left-side view of a bottle side pocket of the exercise shorts being shown in use.  
FIG. 12 is an enlarged front inside view of the upper pocket portion of the exercise shorts taken from the encircled area in FIG. 1; and,  
FIG. 13 is an enlarged front inside view of the upper pocket portion of the exercise shorts shown in use.  
The broken lines showing the stitching, the phone, the bottle, the credit card, and the hands and partial legs illustrate portions of the exercise shorts and environmental structures that form no part of the claimed design.  
What is shown is a design of a pair of exercise shorts with an elastoretractive opening at the crotch.

(56) **References Cited**

U.S. PATENT DOCUMENTS

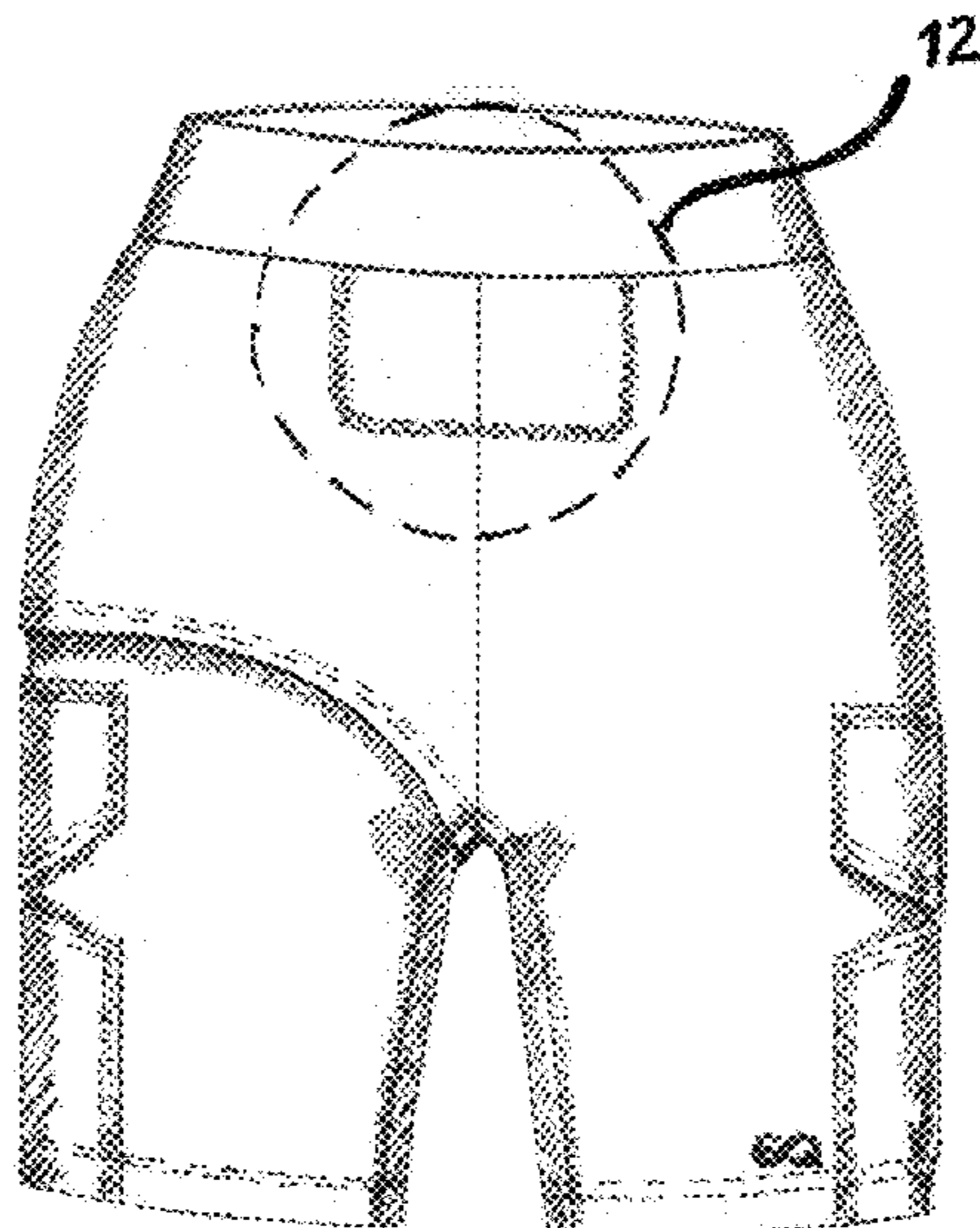
2,703,404 A	3/1955	Lawson	
4,334,326 A	6/1982	Mallow	
4,602,390 A	7/1986	Morera et al.	
5,014,364 A	5/1991	Orr	
5,201,074 A	4/1993	Dicker	
D339,902 S *	10/1993	Doherty	D2/738
D378,947 S *	4/1997	Desmond	D2/701
D572,430 S *	7/2008	Wong	D2/712
D656,711 S *	4/2012	Kemma	D2/738
D668,840 S *	10/2012	McCray	D2/738
D673,347 S *	1/2013	Sumpton	D2/738
D685,156 S *	7/2013	Carney	D2/712
D702,018 S *	4/2014	Ferraro	D2/712
D716,525 S *	11/2014	Astin	D2/712
D722,420 S *	2/2015	Abrams	D2/712

(Continued)

*Primary Examiner* — Michelle E. Wilson

*Assistant Examiner* — Clese Moore, Jr.

**1 Claim, 13 Drawing Sheets**



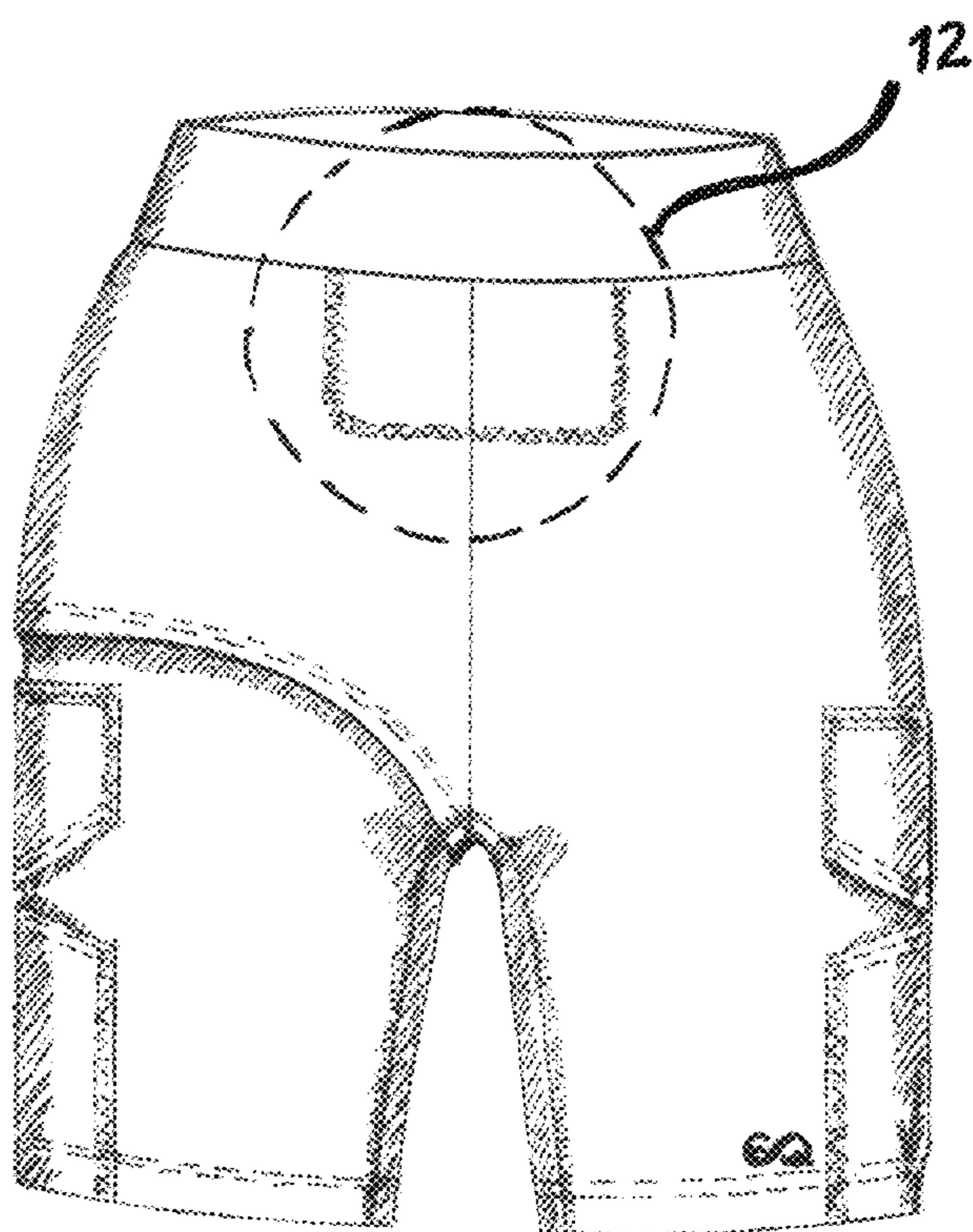
(56)

References Cited

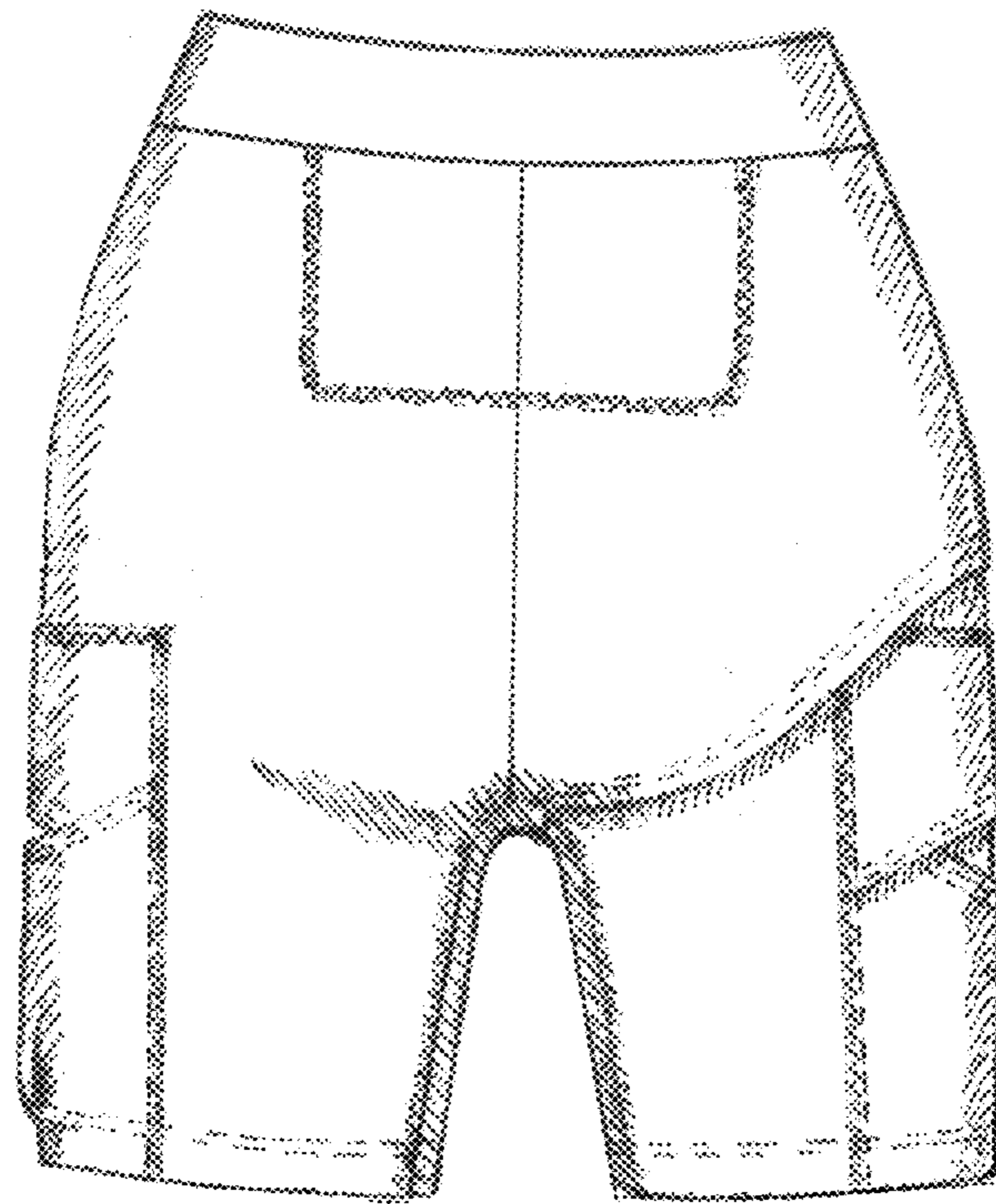
U.S. PATENT DOCUMENTS

D722,742	S *	2/2015	Abrams	.....	D2/712
D746,544	S *	1/2016	Curran	.....	D2/738
D756,069	S *	5/2016	Astin	.....	D2/716
D759,345	S *	6/2016	Astin	.....	D2/712
D768,357	S *	10/2016	White	.....	D2/731
D774,727	S *	12/2016	McCombs	.....	D2/712
D775,453	S *	1/2017	McCombs	.....	D2/712
D775,784	S *	1/2017	Puni	.....	D2/731
D783,938	S *	4/2017	Todd	.....	D2/731
D785,283	S *	5/2017	Harmon	.....	D2/712
D790,157	S *	6/2017	Handlon	.....	D2/731
D794,904	S *	8/2017	Johnston	.....	D2/700
D798,530	S *	10/2017	Cook	.....	D2/700
D817,598	S *	5/2018	Collins	.....	D2/712
D817,600	S *	5/2018	Brown	.....	D2/731
D838,931	S *	1/2019	Yan	.....	D2/712
D848,111	S *	5/2019	Levy	.....	D2/712
D860,588	S *	9/2019	Noll	.....	D2/738
D864,523	S *	10/2019	Diamond	.....	D2/712
D871,020	S *	12/2019	Williams	.....	D2/712
D873,529	S *	1/2020	Tubbs-Gingerich	.....	D2/731
D895,929	S *	9/2020	McCombs	.....	D2/712
2014/0182048	A1 *	7/2014	Gregory	.....	A41B 9/005 2/400
2015/0157058	A1 *	6/2015	McCombs	.....	A41B 9/005 2/400
2015/0231482	A1 *	8/2015	Ziehler	.....	A41B 9/023 2/403

\* cited by examiner

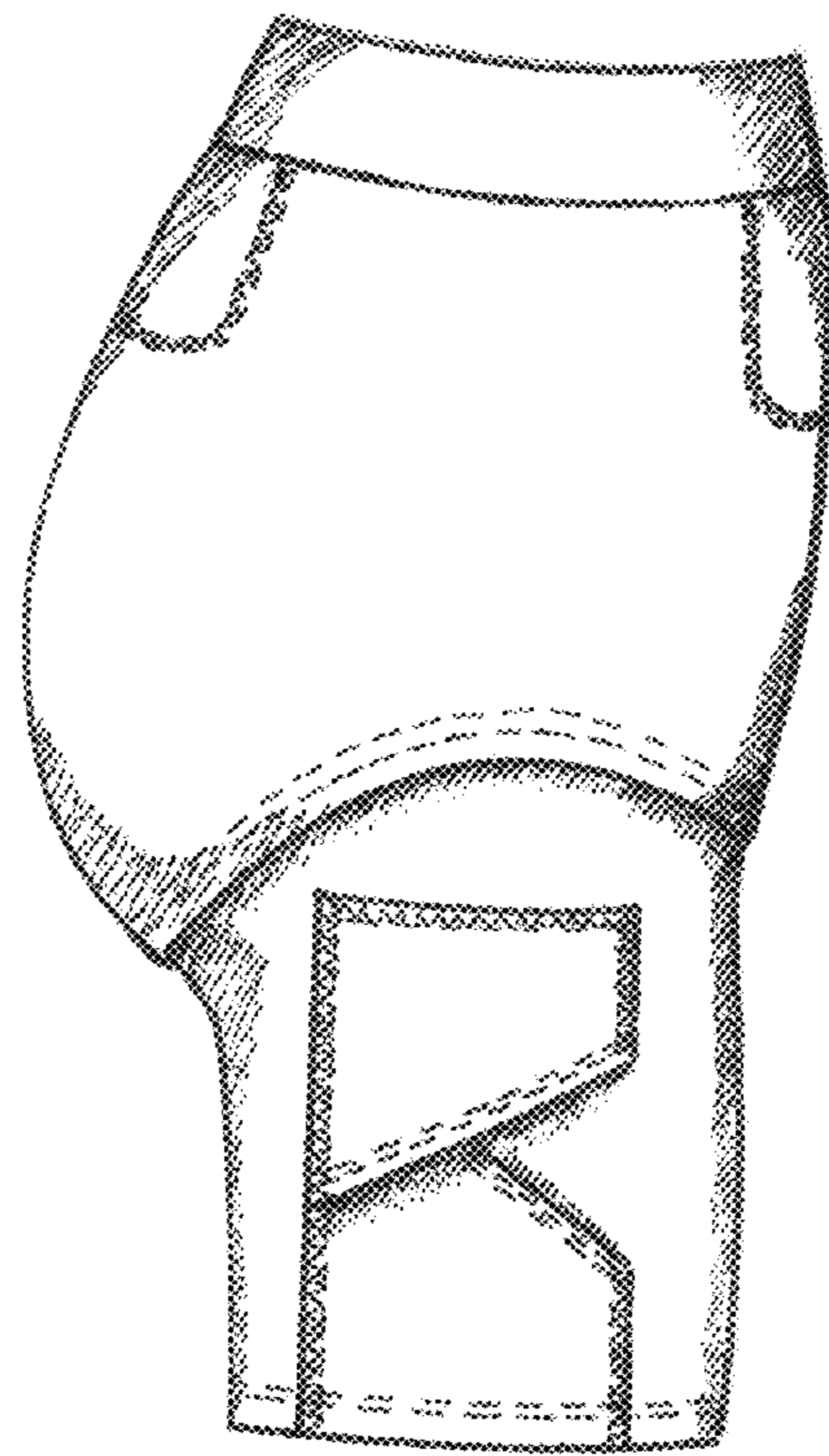


**FIGURE 1**

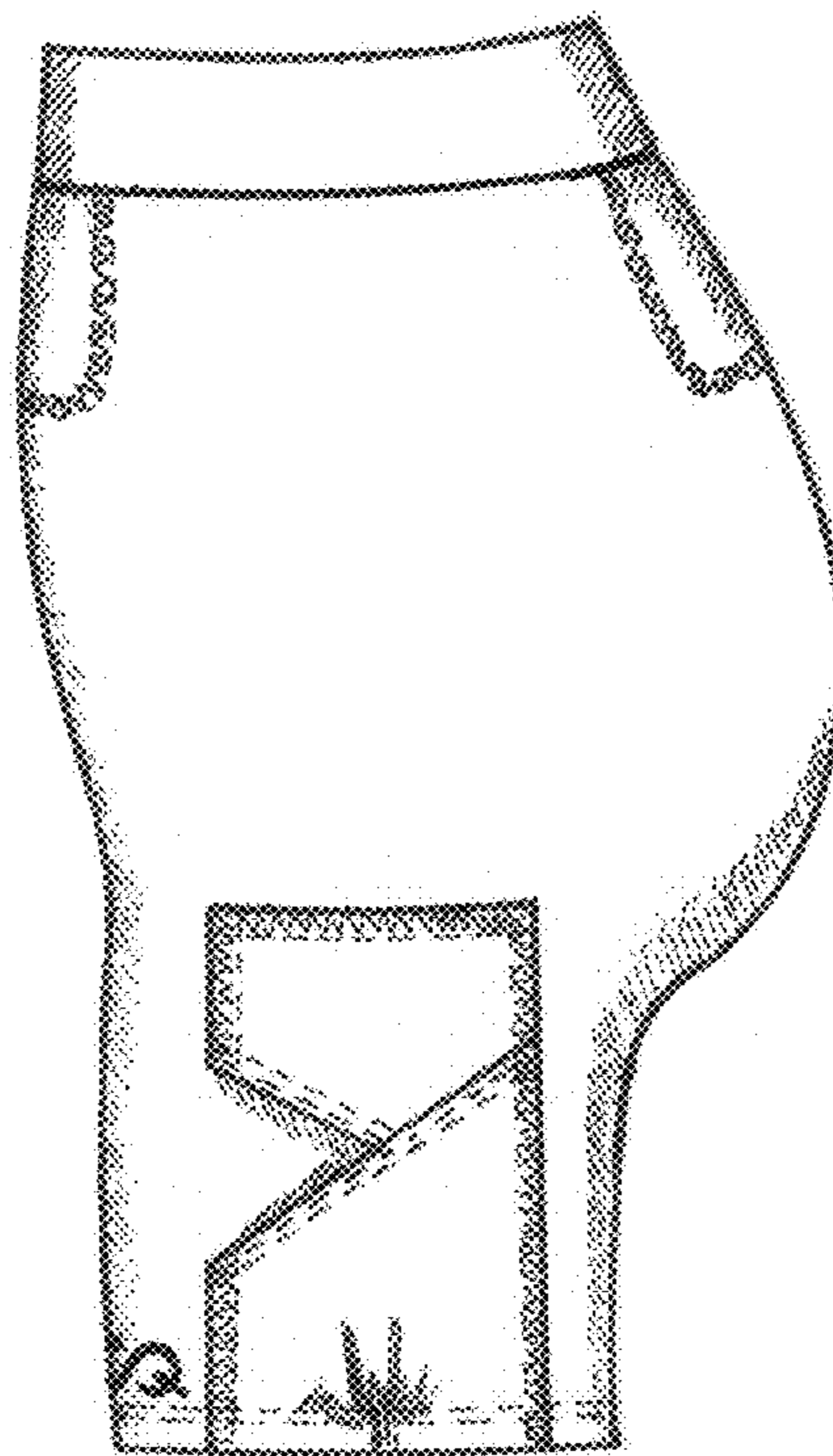


**FIGURE 2**

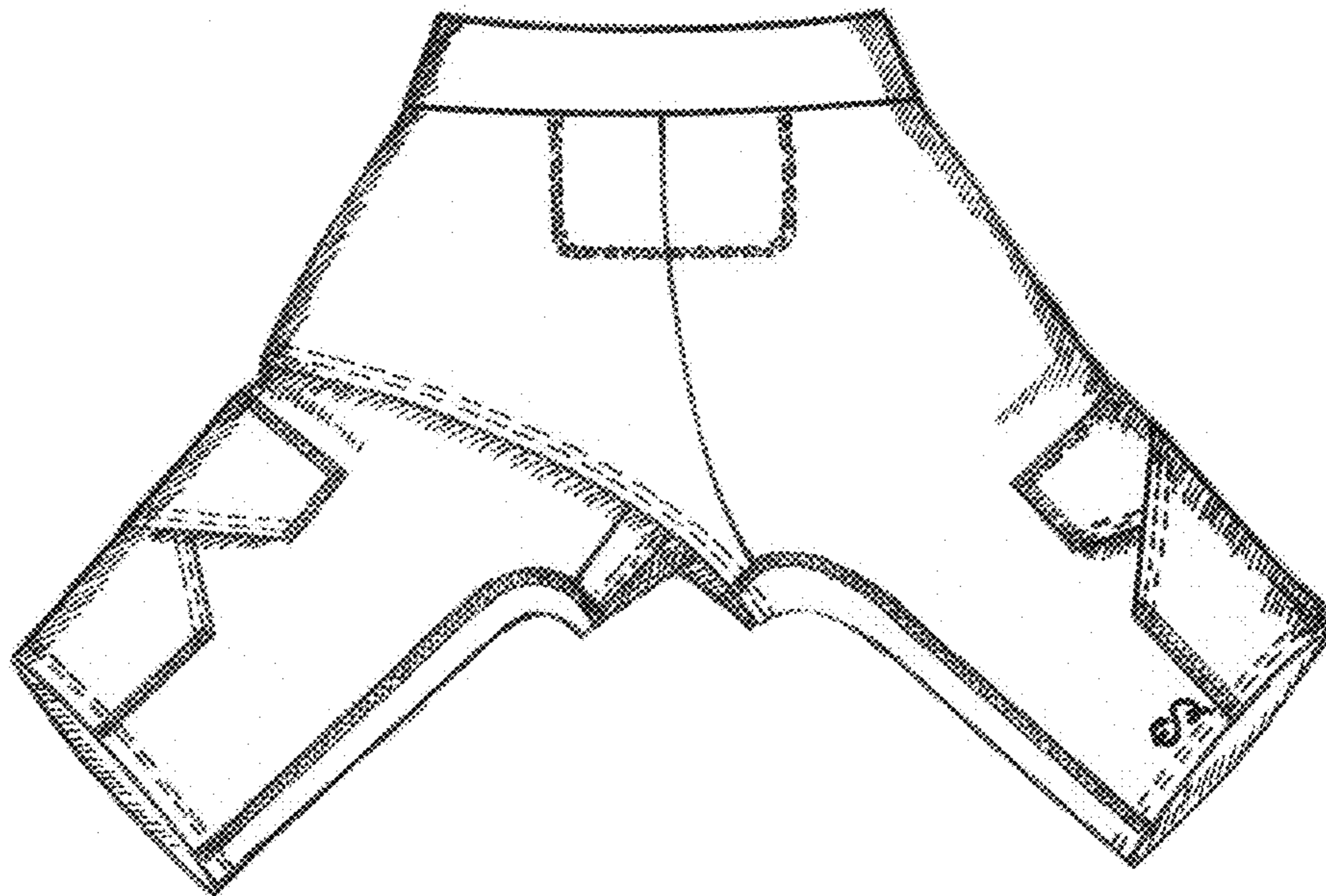




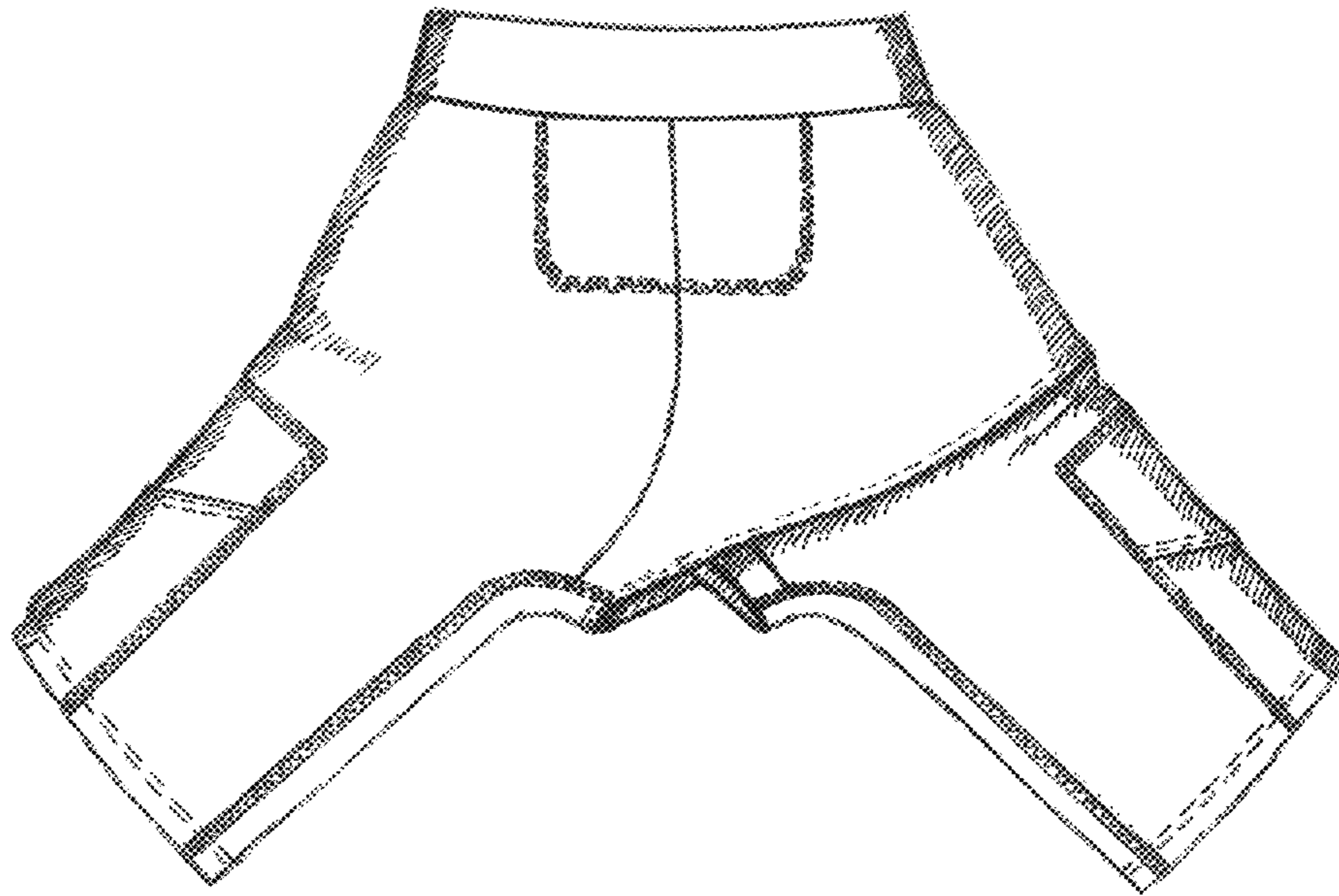
**FIGURE 3**



**FIGURE 4**

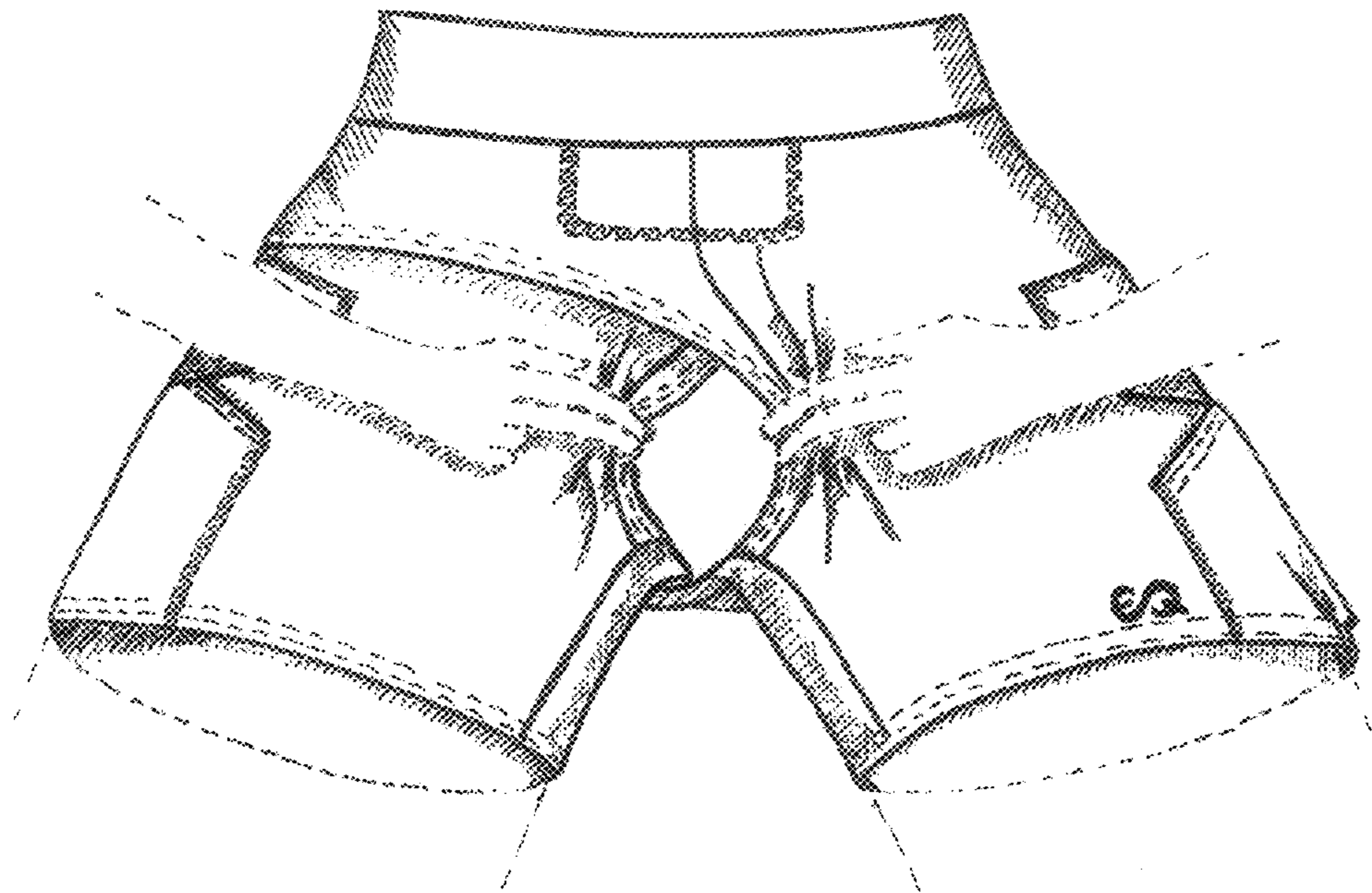


**FIGURE 5**

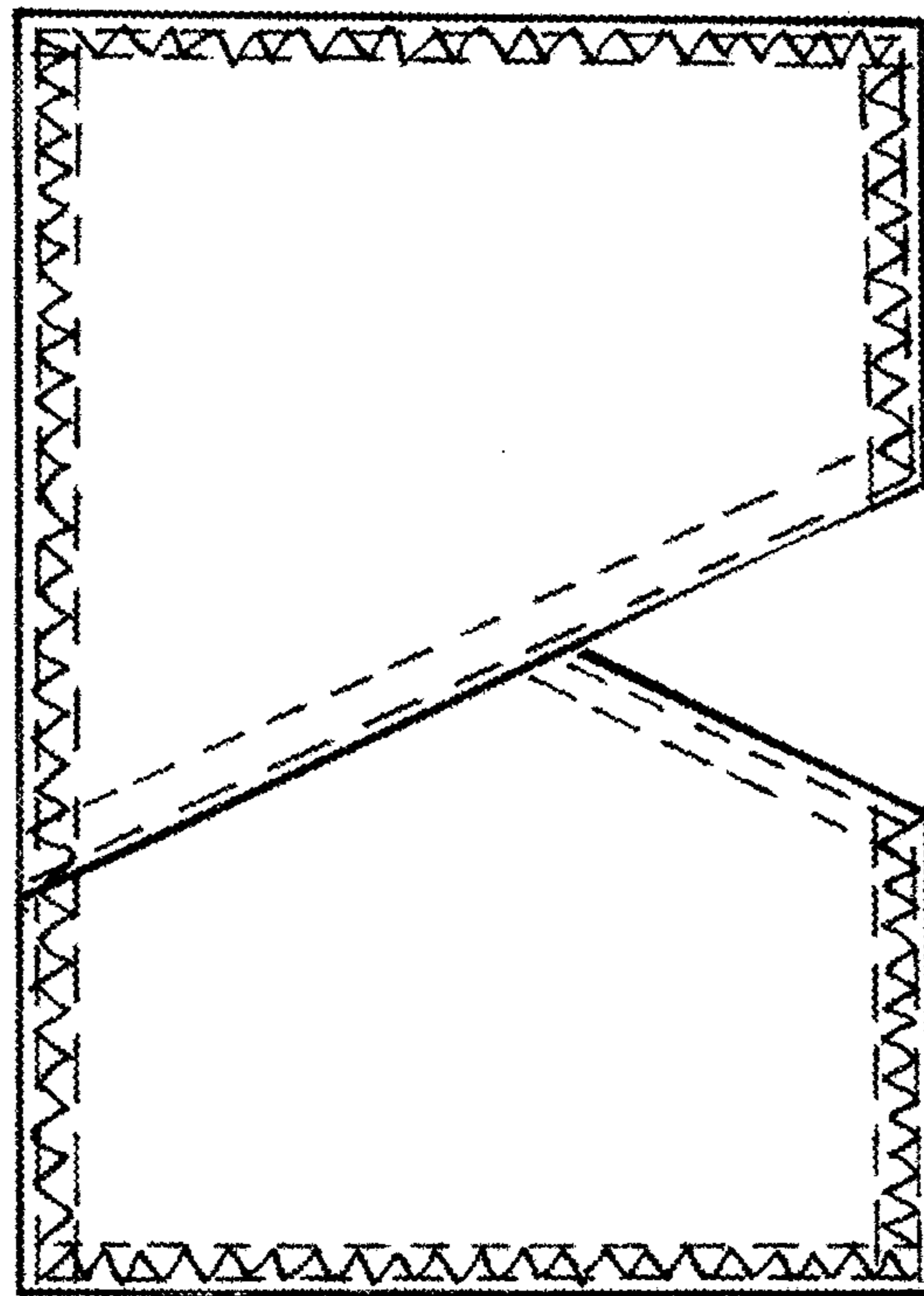


**FIGURE 6**

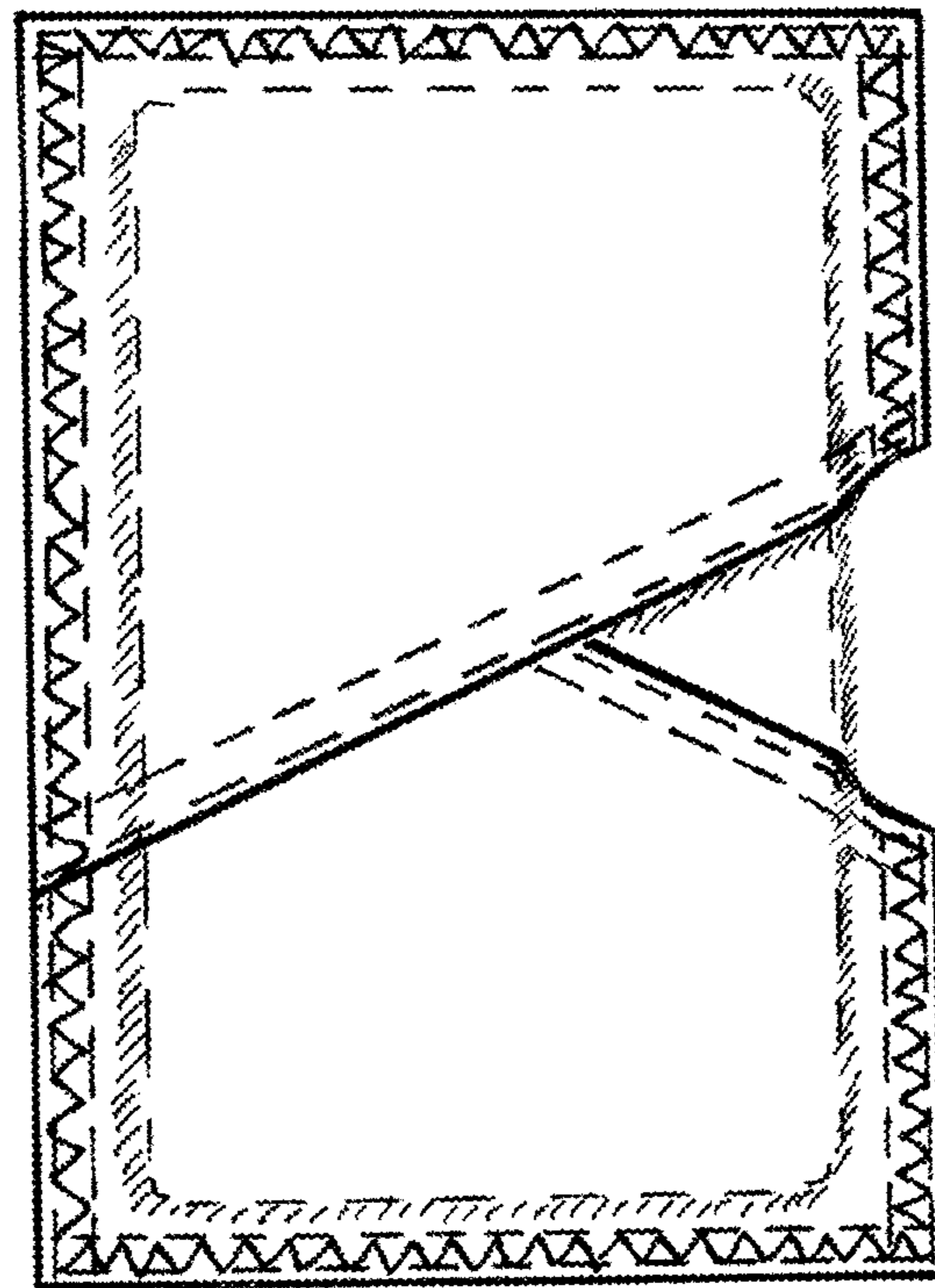




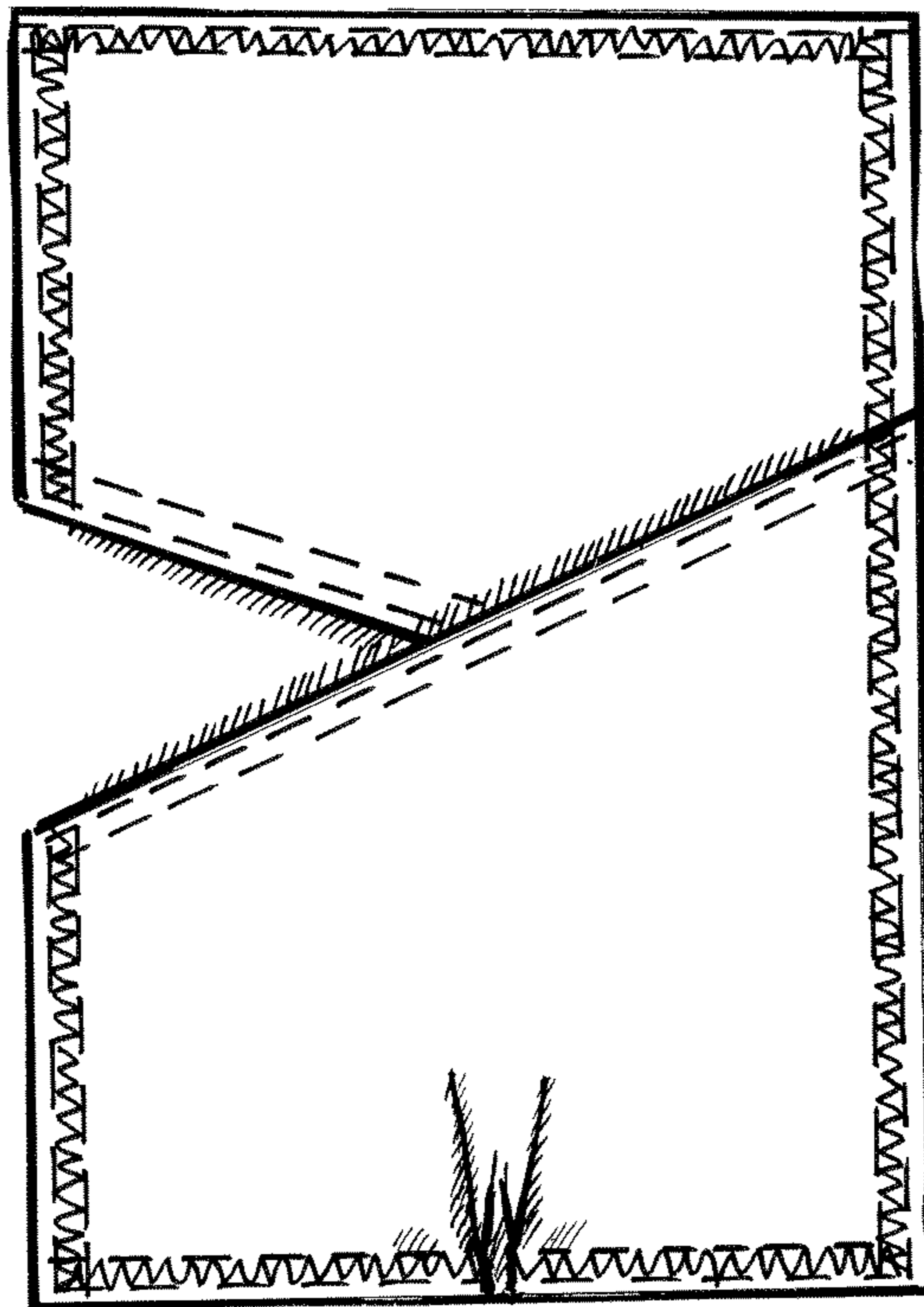
**FIGURE 7**



**FIGURE 8**

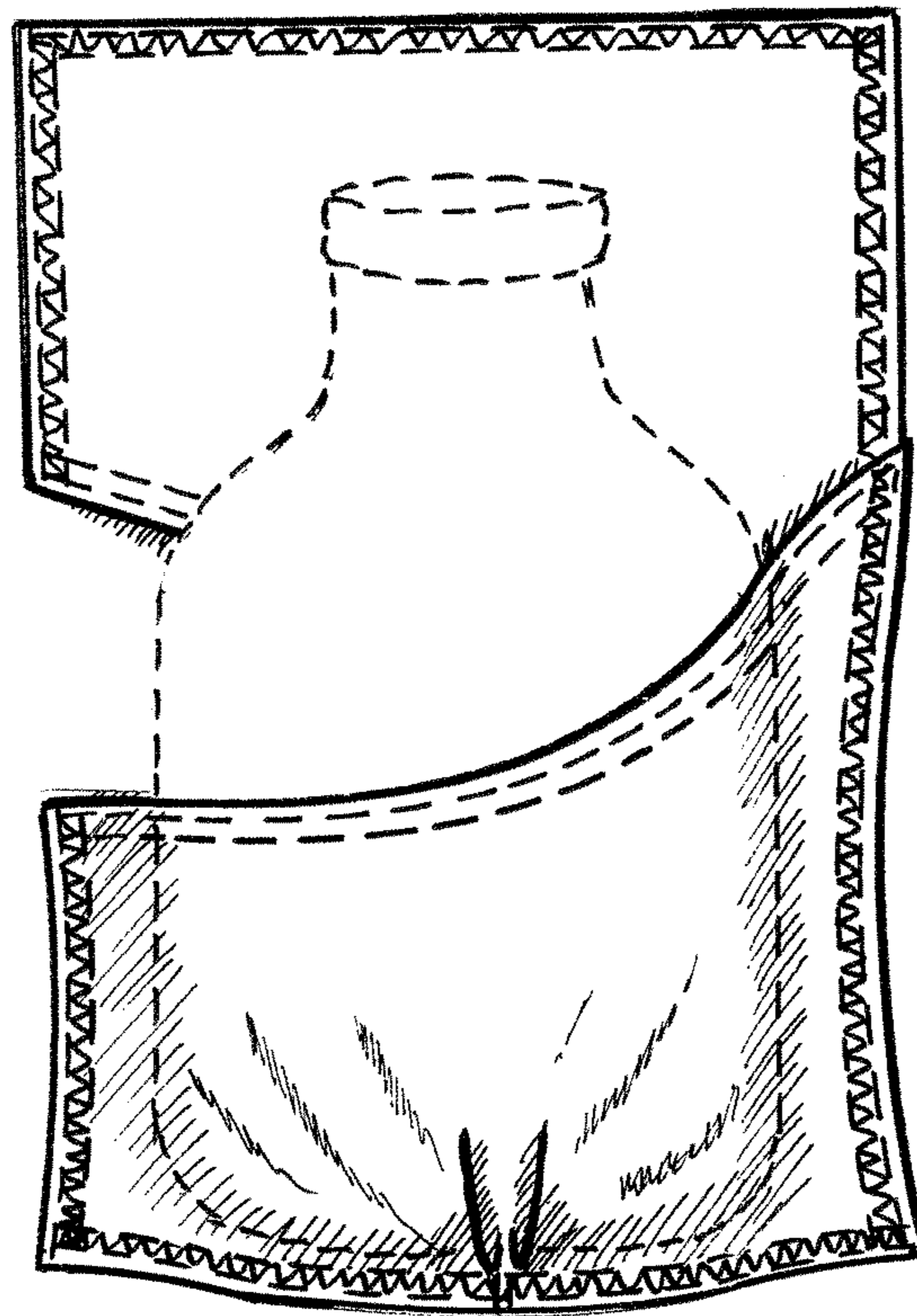


**FIGURE 9**

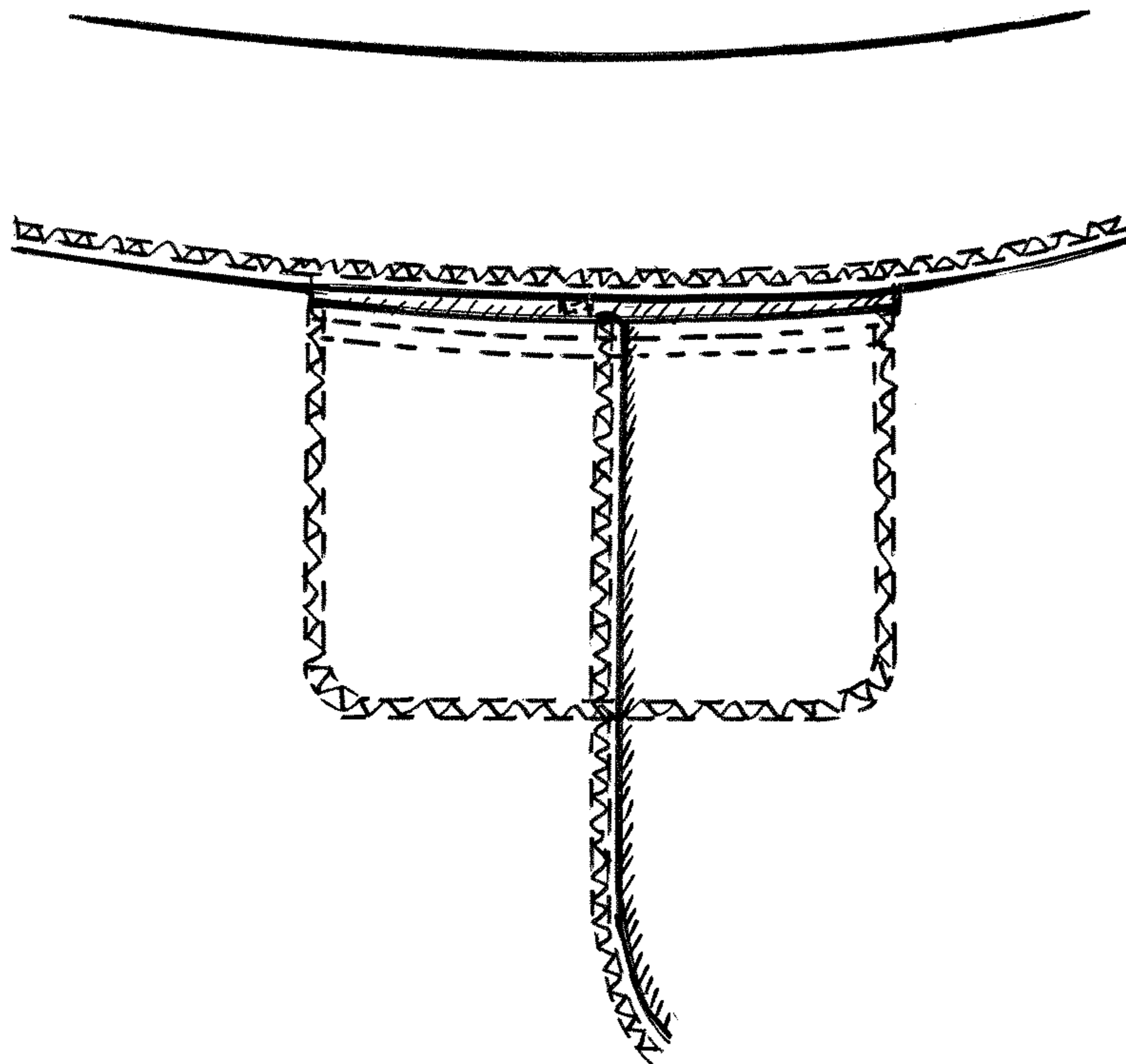


**FIGURE 10**

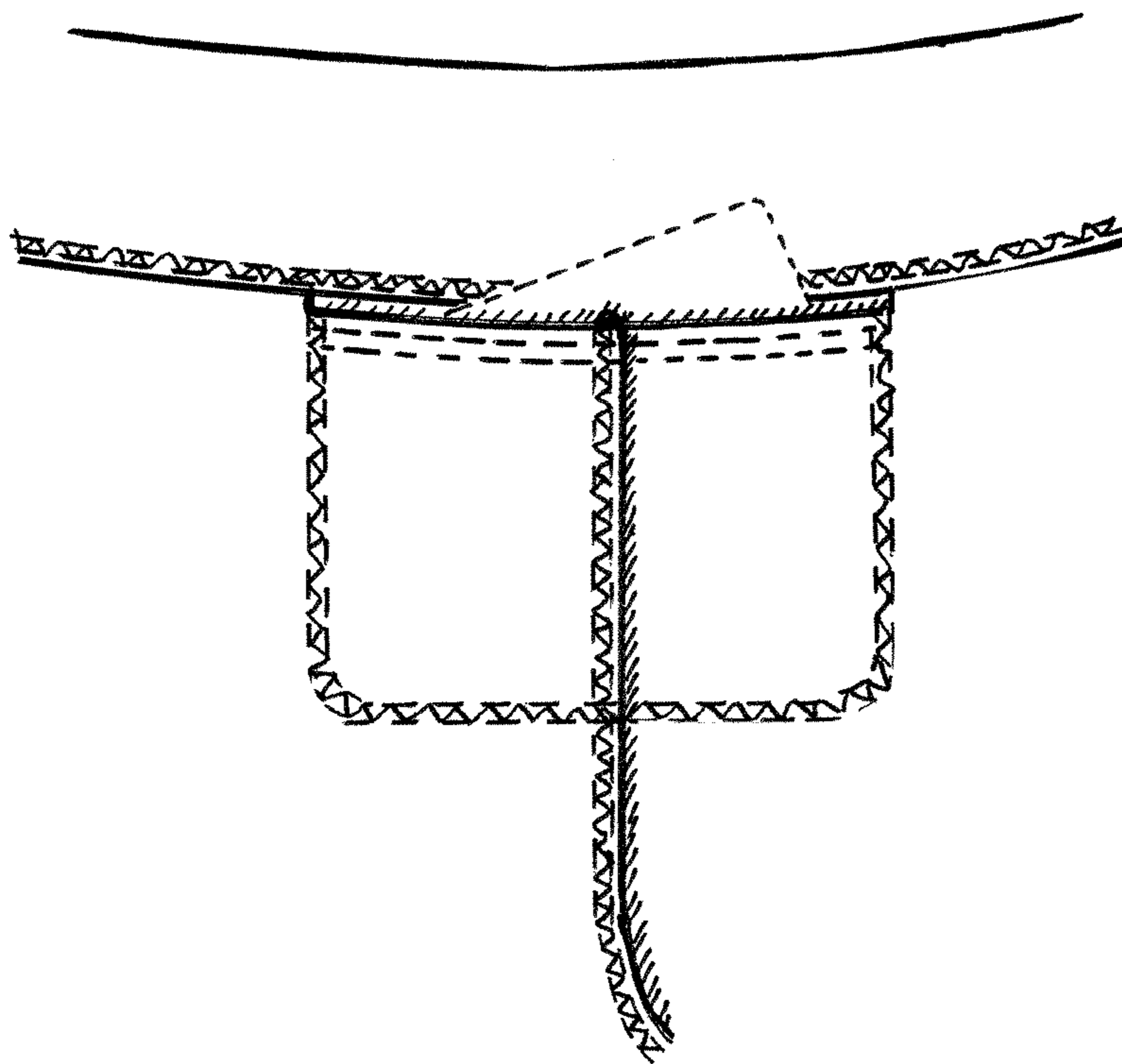




**FIGURE 11**



**FIGURE 12**



**FIGURE 13**