



US00D939174S

(12) **United States Design Patent**  
**Zeng**

(10) **Patent No.:** **US D939,174 S**

(45) **Date of Patent:** **\*\* Dec. 21, 2021**

(54) **TRASH CAN**

(71) Applicant: **Huayou Zeng**, Jinjiang (CN)

(72) Inventor: **Huayou Zeng**, Jinjiang (CN)

(\*\*) Term: **15 Years**

(21) Appl. No.: **29/766,747**

(22) Filed: **Jan. 18, 2021**

(51) **LOC (13) Cl.** ..... **09-09**

(52) **U.S. Cl.**  
USPC ..... **D34/7**

(58) **Field of Classification Search**

USPC ..... D34/1, 7, 8, 9, 10, 11  
CPC .. B65F 1/06; B65F 1/163; B65F 1/062; B65F  
1/1607; B65F 1/1605; B65F 1/16; B65F  
1/14; B65F 2220/12; B65F 2230/00;  
B65F 2250/1146

See application file for complete search history.

(56) **References Cited**

**U.S. PATENT DOCUMENTS**

D587,566 S \* 3/2009 Albrecht ..... D9/424  
D593,269 S \* 5/2009 Weiler ..... D32/53  
D644,389 S \* 8/2011 Roberts ..... D34/7

D722,735 S \* 2/2015 Del Rosario Roy ..... D34/8  
D773,769 S 12/2016 Chen  
D806,974 S \* 1/2018 Lloyd ..... D34/7  
D831,288 S 10/2018 Thuma et al.  
D900,422 S \* 10/2020 Joseph ..... D34/7  
D909,000 S \* 1/2021 Grossman ..... D34/7  
2010/0193534 A1 \* 8/2010 Roberts ..... B65F 1/1615  
220/810

\* cited by examiner

*Primary Examiner* — Cynthia Ramirez

(57) **CLAIM**

The ornamental design for a trash can, as shown and described.

**DESCRIPTION**

FIG. 1 is a perspective view of a trash can showing my new design;  
FIG. 2 is another perspective view thereof;  
FIG. 3 is a front elevational view thereof;  
FIG. 4 is a rear elevational view thereof;  
FIG. 5 is a left side elevational view thereof;  
FIG. 6 is a right side elevational view thereof;  
FIG. 7 is a top plan view thereof;  
FIG. 8 is a bottom plan view thereof; and,  
FIG. 9 is an exploded perspective view of the trash can.  
The broken lines in the drawings depict boundaries of the trash can that form no part of the claimed design.

**1 Claim, 9 Drawing Sheets**

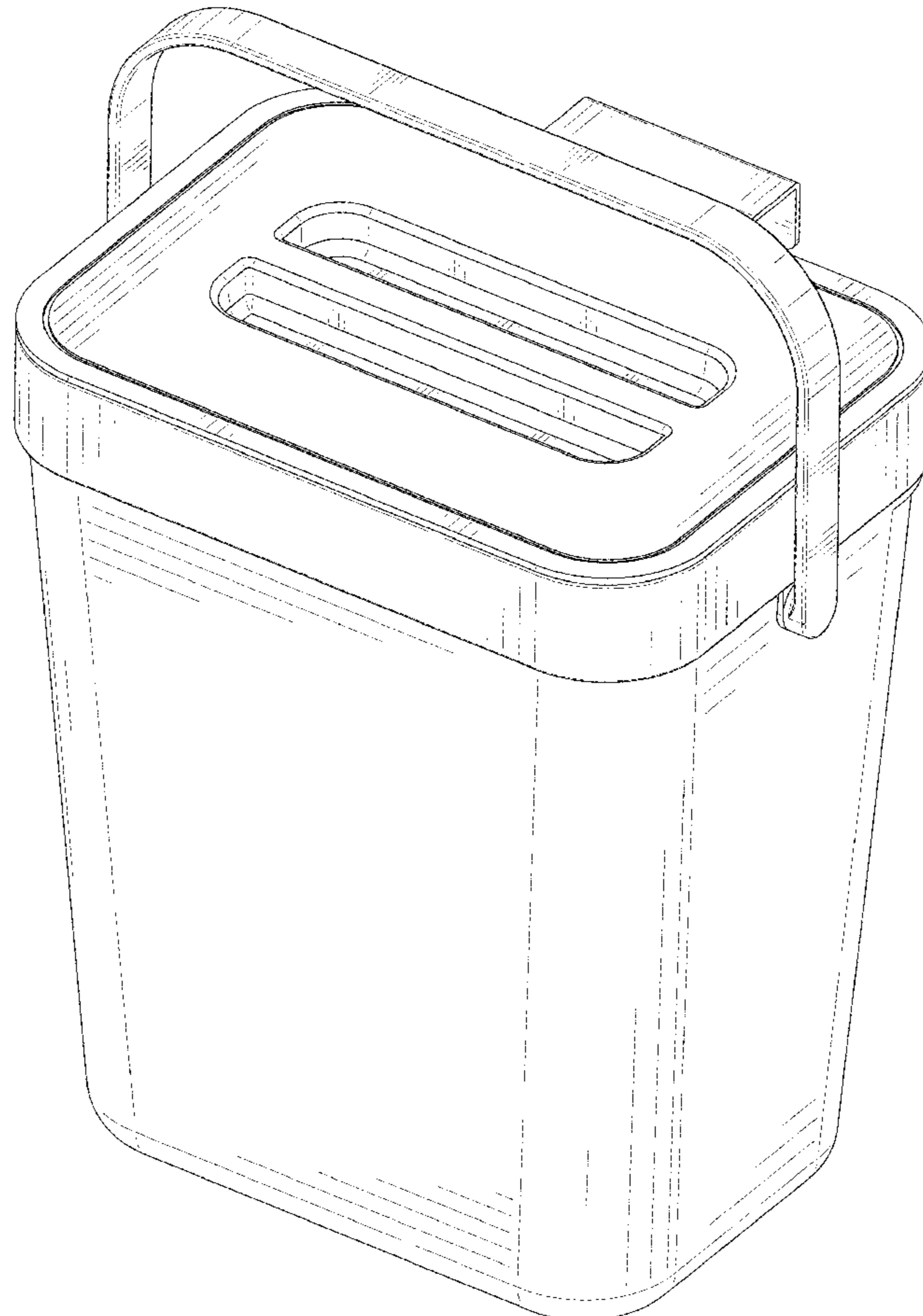

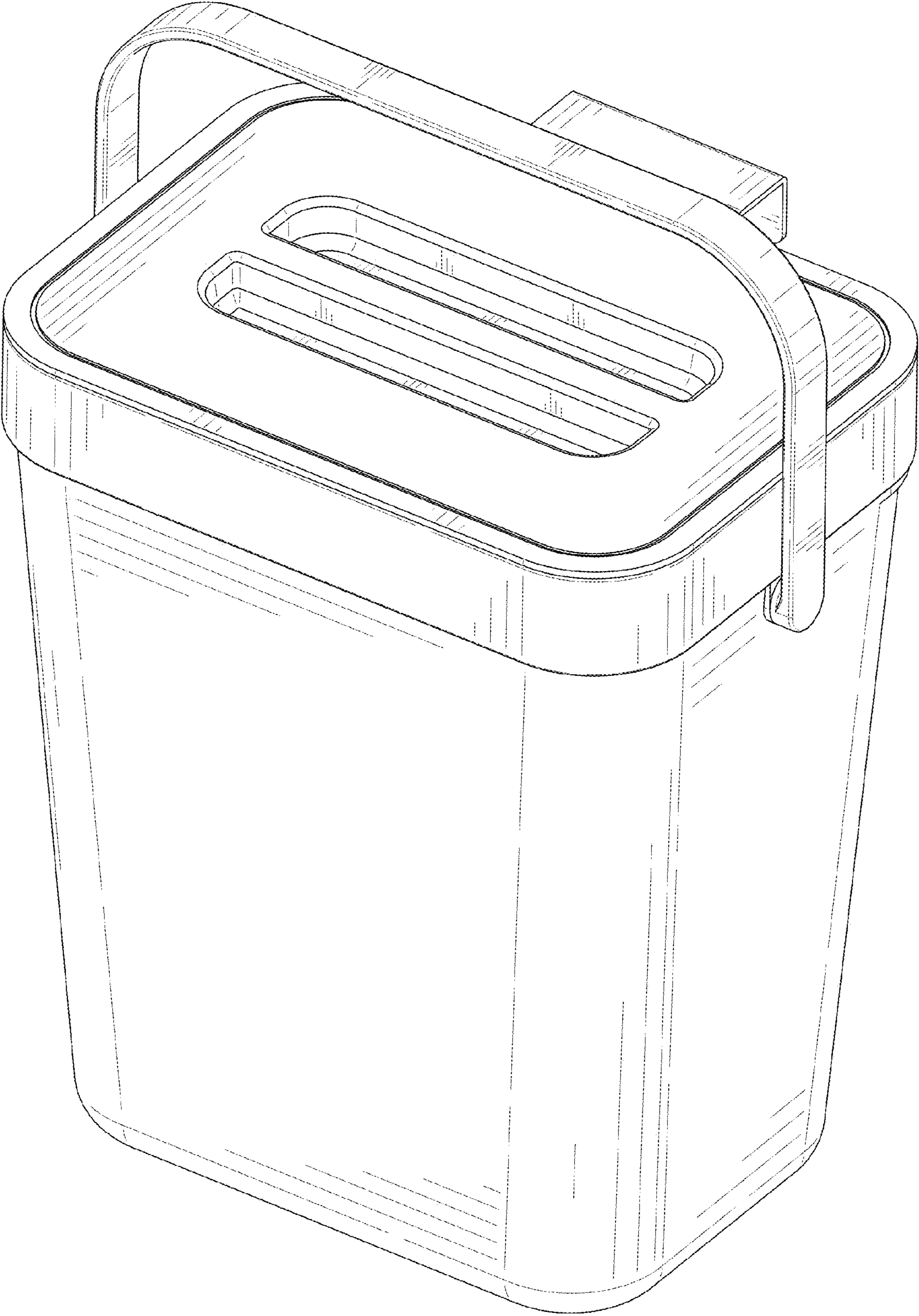

FIG. 1

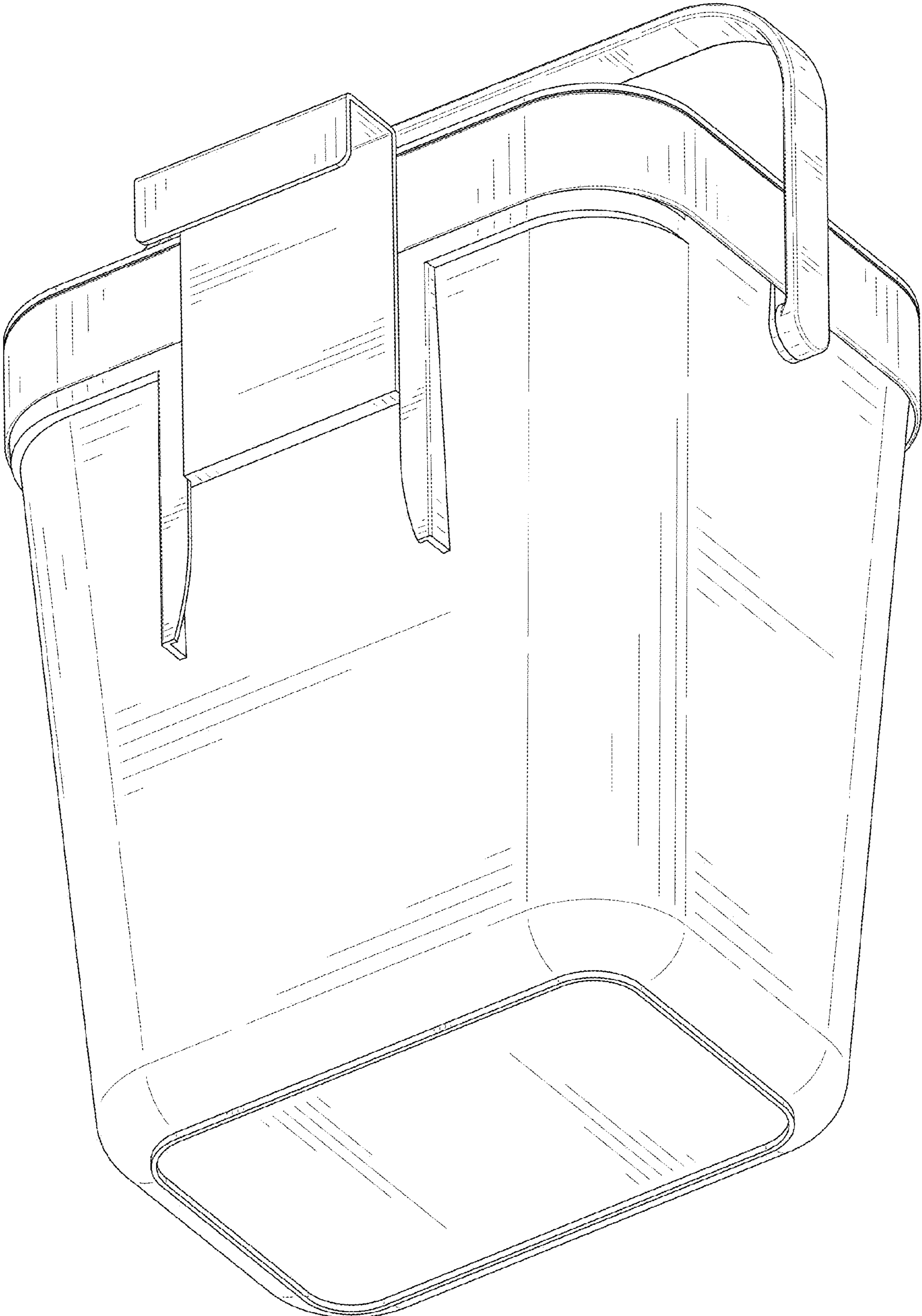

FIG. 2

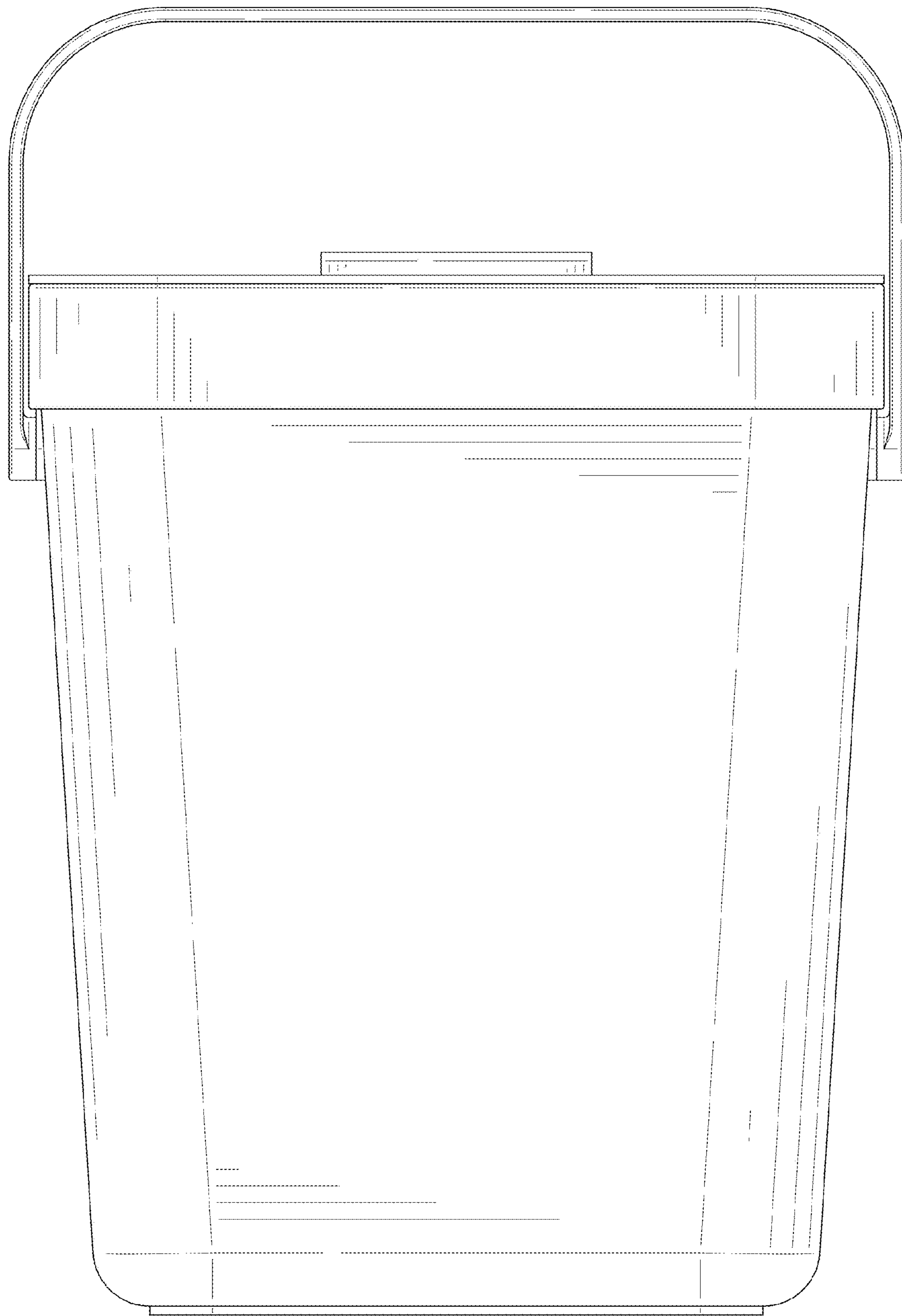

FIG. 3

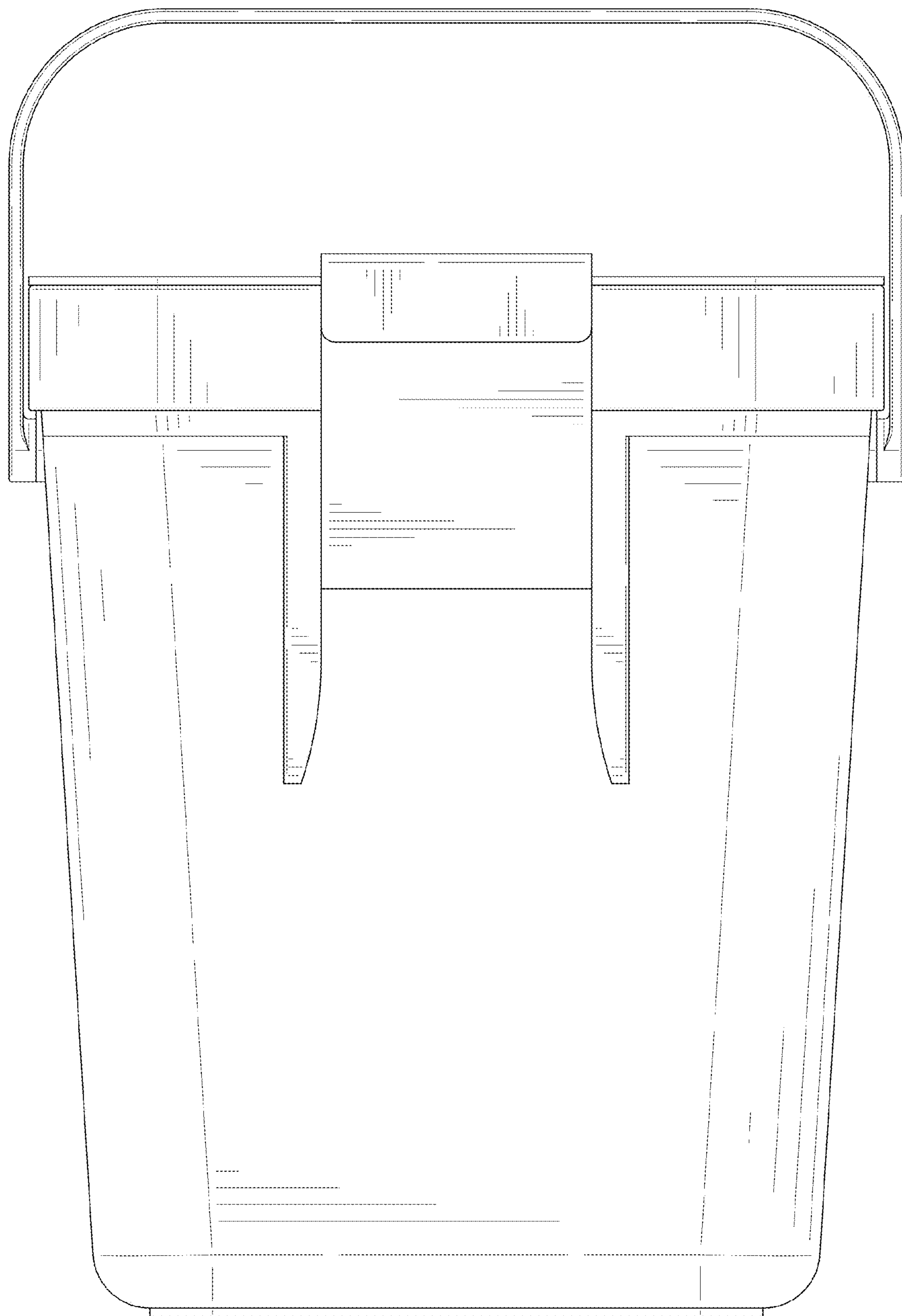

FIG. 4

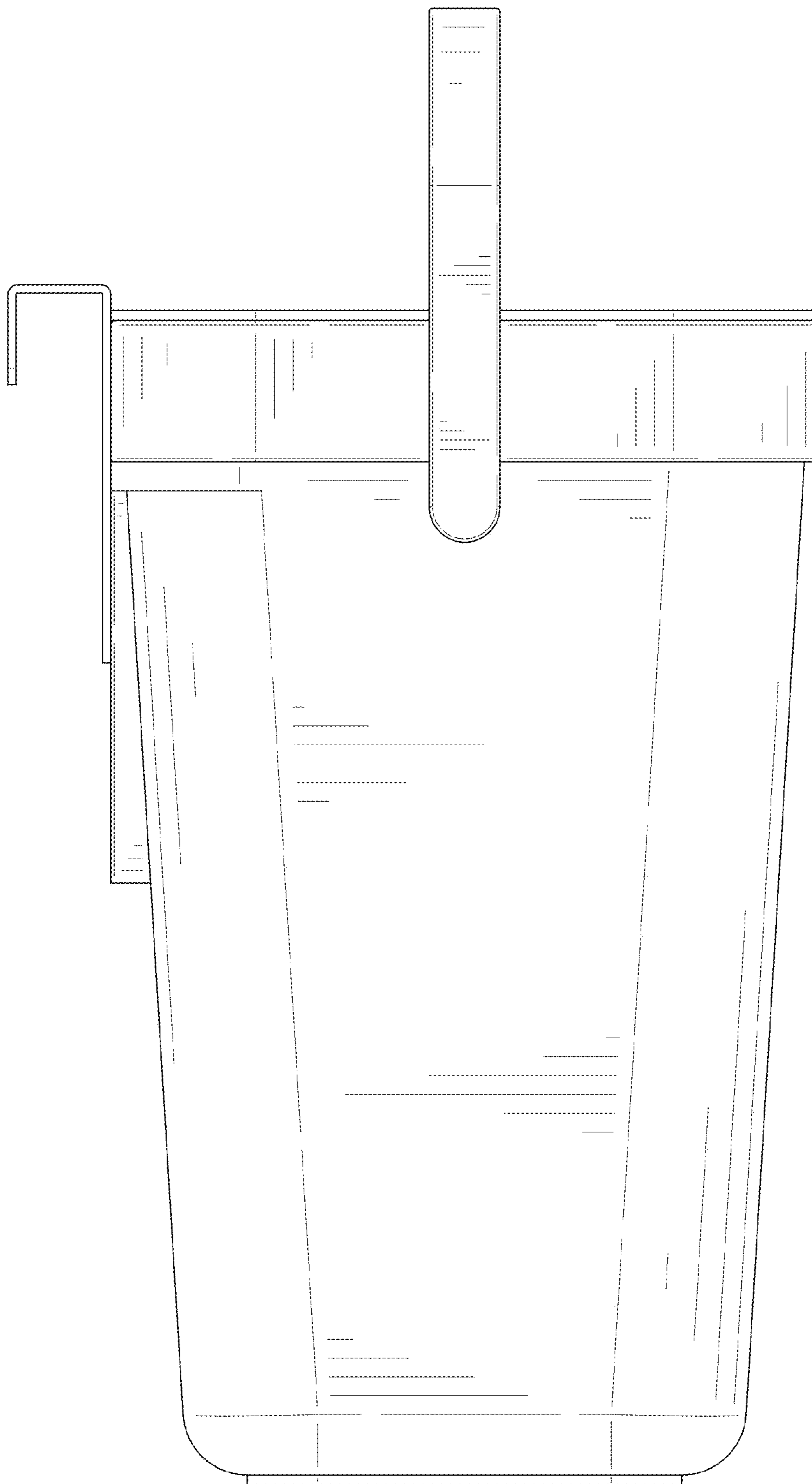

FIG. 5

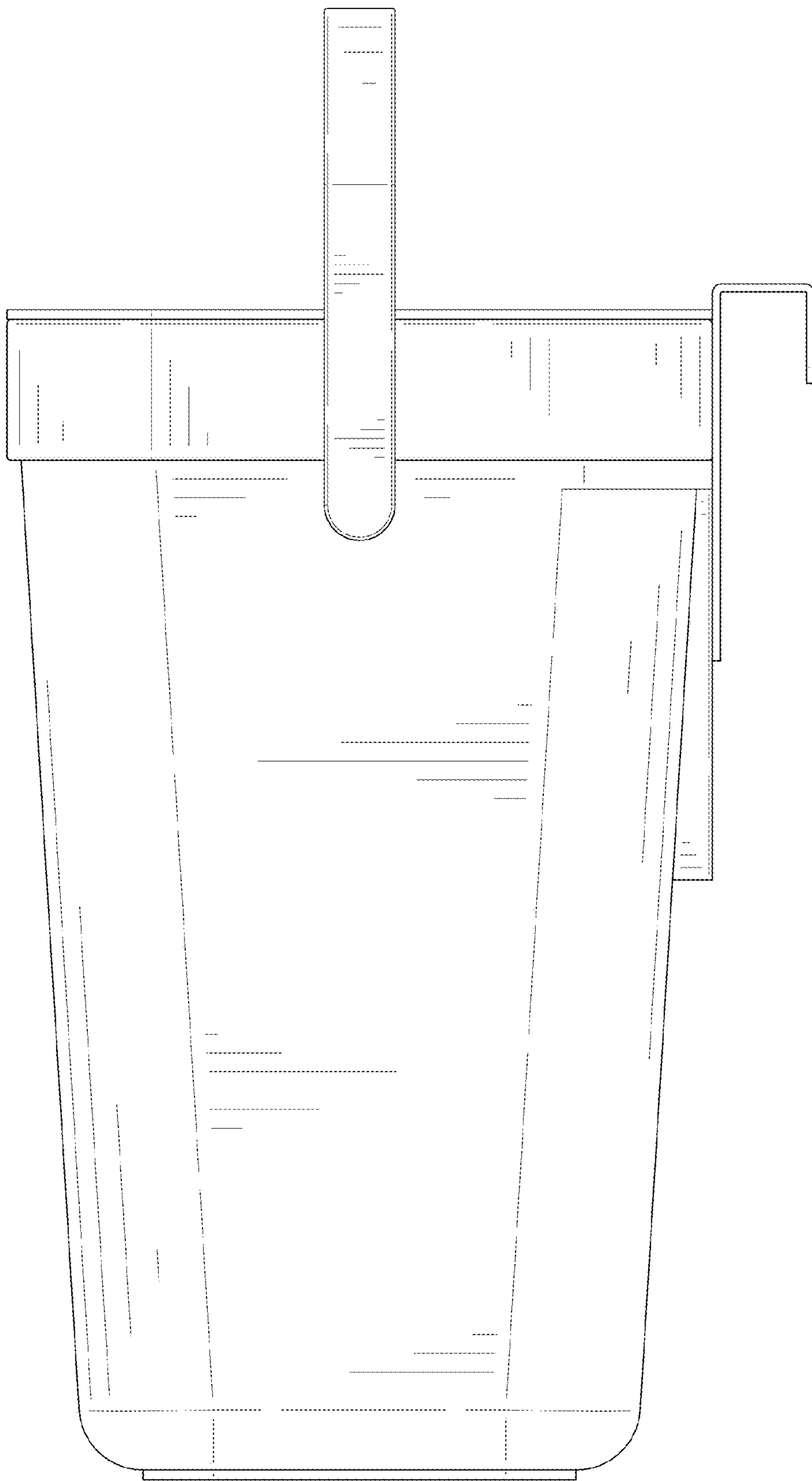

FIG. 6

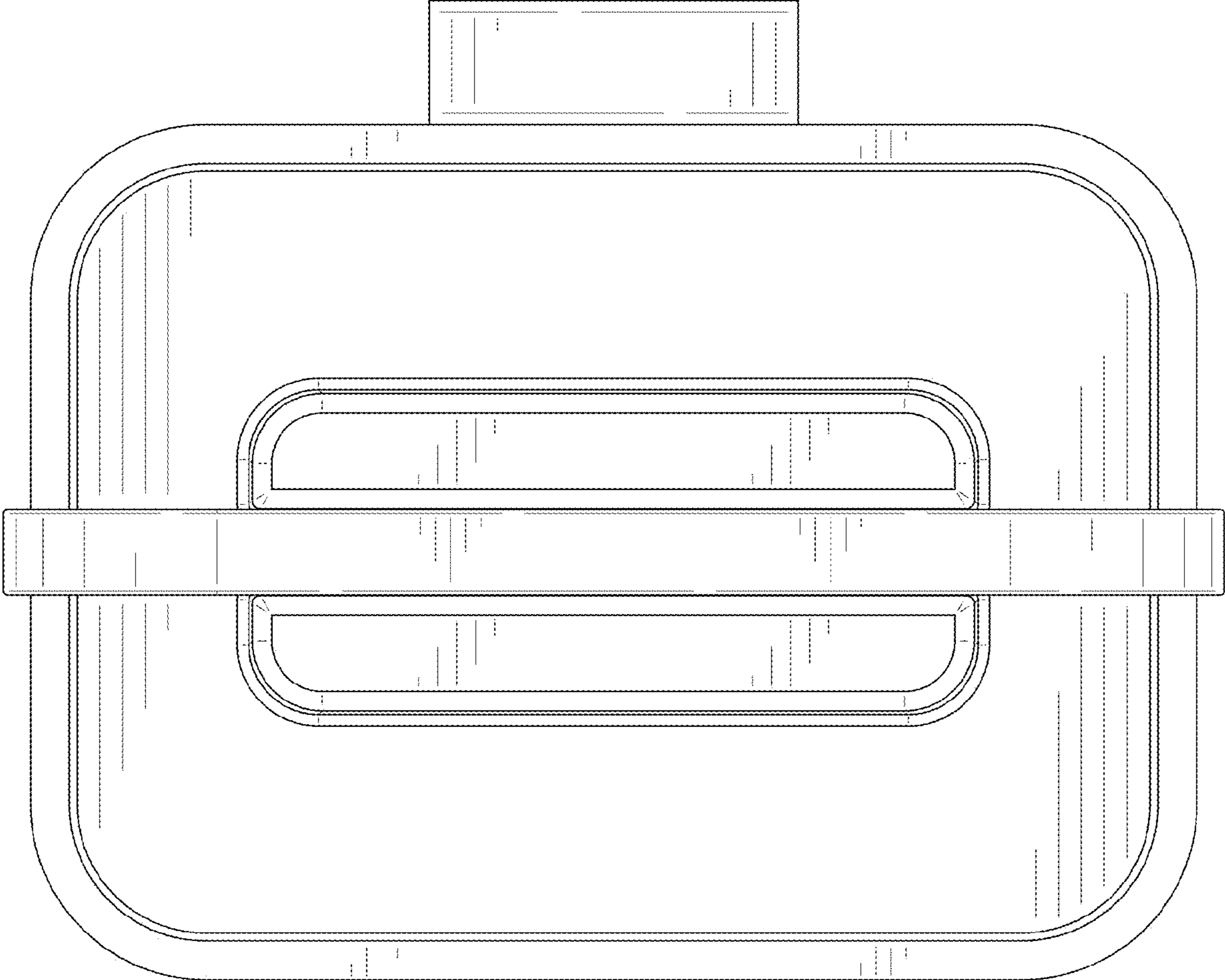

FIG. 7



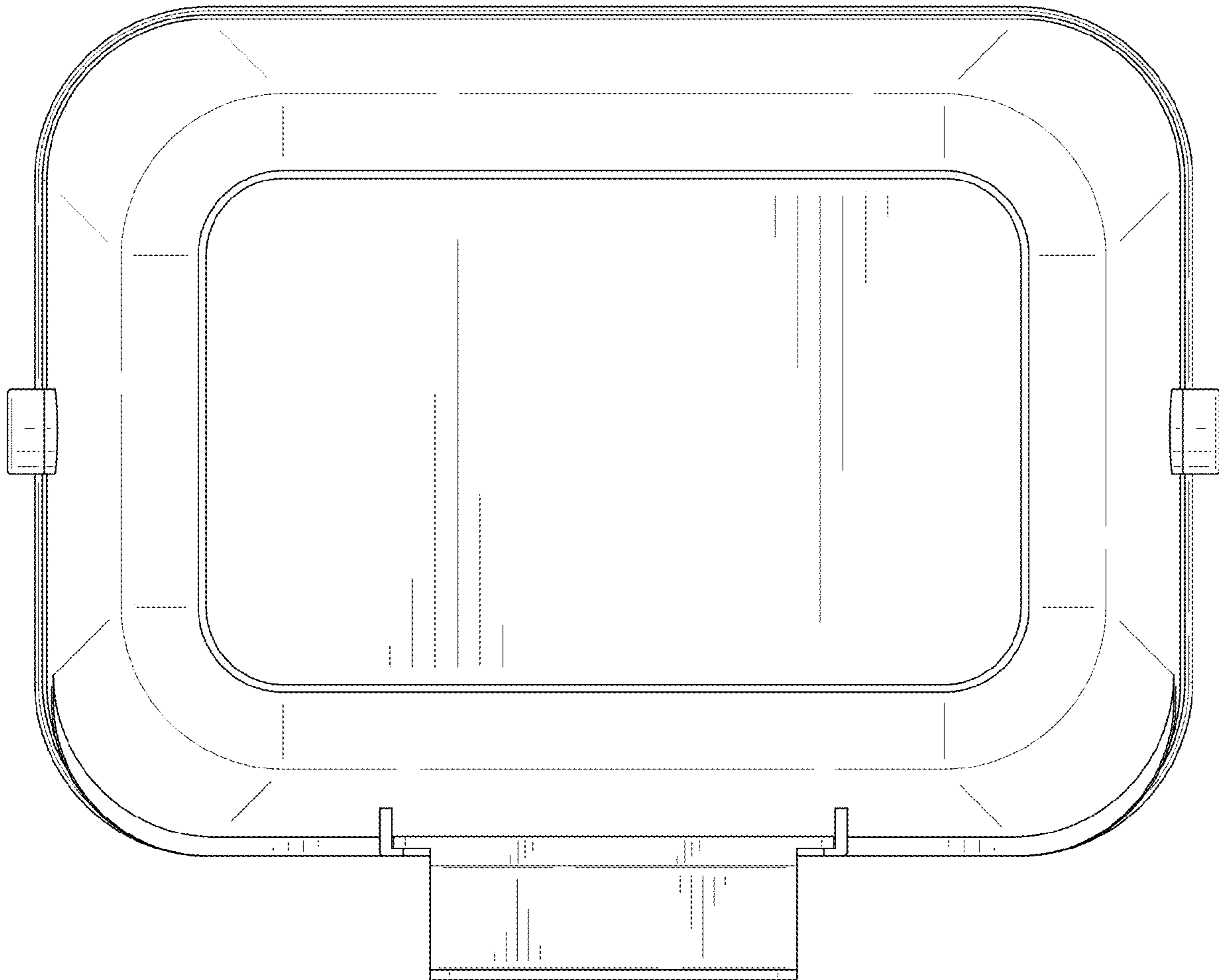

FIG. 8

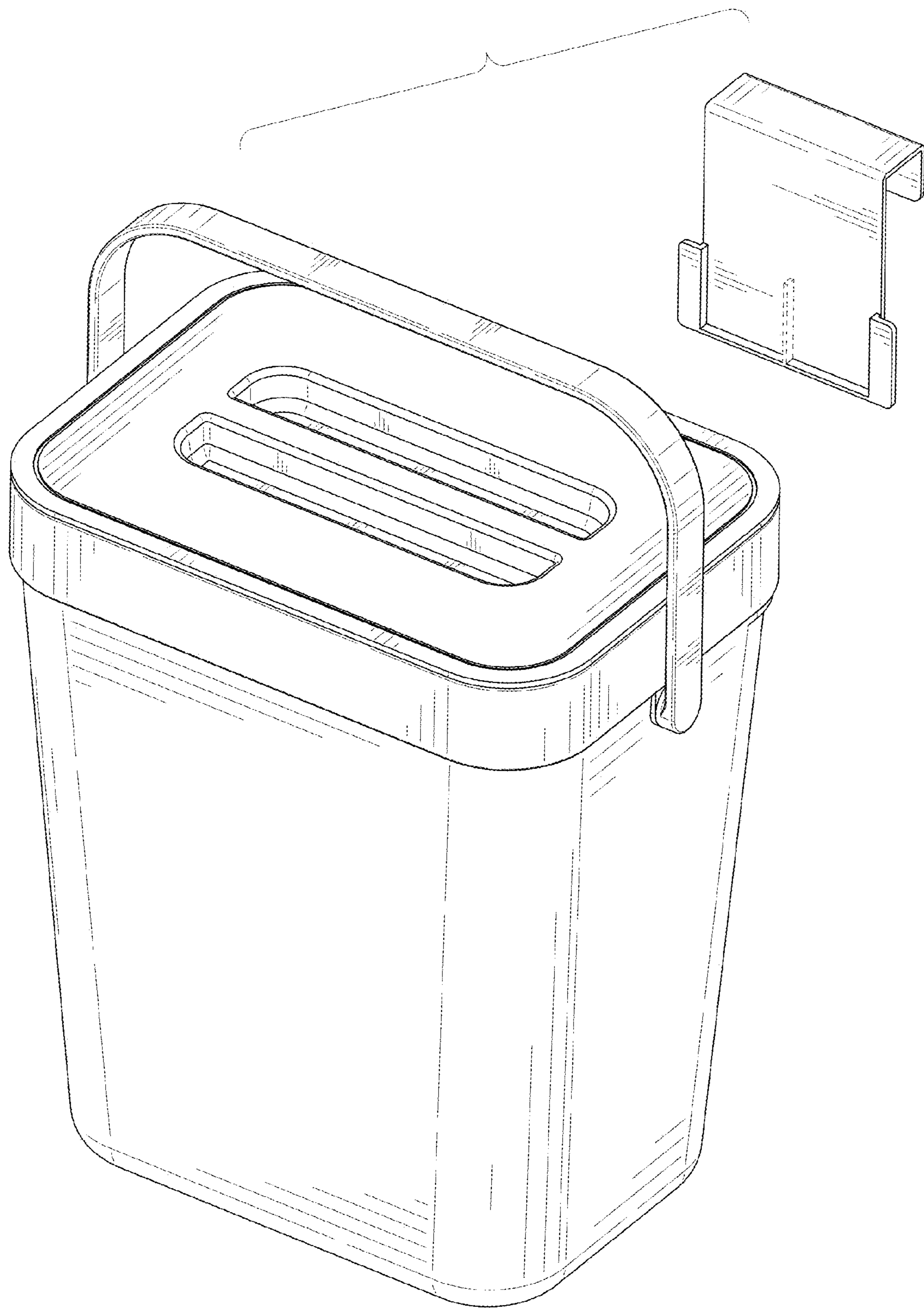

FIG. 9