



US00D939146S

(12) **United States Design Patent** (10) **Patent No.:** **US D939,146 S**
Geisinsky (45) **Date of Patent:** **** Dec. 21, 2021**

(54) **WIG GRIP BAND**

(71) Applicant: **NG Imports, Inc.**, Long Beach, CA
(US)

(72) Inventor: **Yehudis Geisinsky**, Long Beach, CA
(US)

(73) Assignee: **NG Imports, Inc.**, Signal Hill, CA
(US)

(**) Term: **15 Years**

(21) Appl. No.: **29/760,459**

(22) Filed: **Dec. 1, 2020**

(51) **LOC (13) Cl.** **28-04**

(52) **U.S. Cl.**
USPC **D28/93**

(58) **Field of Classification Search**
USPC D28/92, 93

(Continued)

(56) **References Cited**

U.S. PATENT DOCUMENTS

1,671,415 A * 5/1928 Eckert A41G 5/0073
132/105

D365,918 S * 1/1996 Izegbu D2/875
(Continued)

FOREIGN PATENT DOCUMENTS

CN 303113653 S 2/2015
CN 305106180 S 4/2019

(Continued)

OTHER PUBLICATIONS

Title: Wigrip; URL: <https://rhythmwigs.com/wigs/wig-band-wigrip/>; Accessed date: Feb. 5, 2021.

(Continued)

Primary Examiner — Zenia I Bennett

(74) *Attorney, Agent, or Firm* — Lance M. Pritikin

(57) **CLAIM**

The ornamental design for a wig grip band, as shown and described.

DESCRIPTION

FIG. 1 is a front perspective view of a first embodiment of a wig grip band, showing my new design;
FIG. 2 is a front elevational view thereof;
FIG. 3 is a rear elevational view thereof;
FIG. 4 is a left side elevational view thereof;
FIG. 5 is a right side elevational view thereof;
FIG. 6 is a top plan view thereof;
FIG. 7 is a bottom plan view thereof;
FIG. 8 is a further front perspective view thereof, wherein the wig grip band is shown deployed on the head of a wearer;
FIG. 9 is a further front view thereof, wherein the wig grip band is shown deployed on the head of a wearer;
FIG. 10 is a further rear view thereof, wherein the wig grip band is shown deployed on the head of a wearer;
FIG. 11 is a further left side view thereof, wherein the wig grip band is shown deployed on the head of a wearer;
FIG. 12 is a further right side view thereof, wherein the wig grip band is shown deployed on the head of a wearer;
FIG. 13 is a further top view thereof, wherein the wig grip band is shown deployed on the head of a wearer;
FIG. 14 is a further bottom view thereof, wherein the wig grip band is shown deployed on the head of a wearer;
FIG. 15 is a front perspective view of a second embodiment of a wig grip band, showing my new design;
FIG. 16 is a front elevational view thereof;
FIG. 17 is a rear elevational view thereof;
FIG. 18 is a left side elevational view thereof;
FIG. 19 is a right side elevational view thereof;
FIG. 20 is a top plan view thereof;
FIG. 21 is a bottom plan view thereof;
FIG. 22 is a further front perspective view thereof, wherein the wig grip band is shown deployed on the head of a wearer;
FIG. 23 is a further front view thereof, wherein the wig grip band is shown deployed on the head of a wearer;
FIG. 24 is a further rear view thereof, wherein the wig grip band is shown deployed on the head of a wearer;

(Continued)

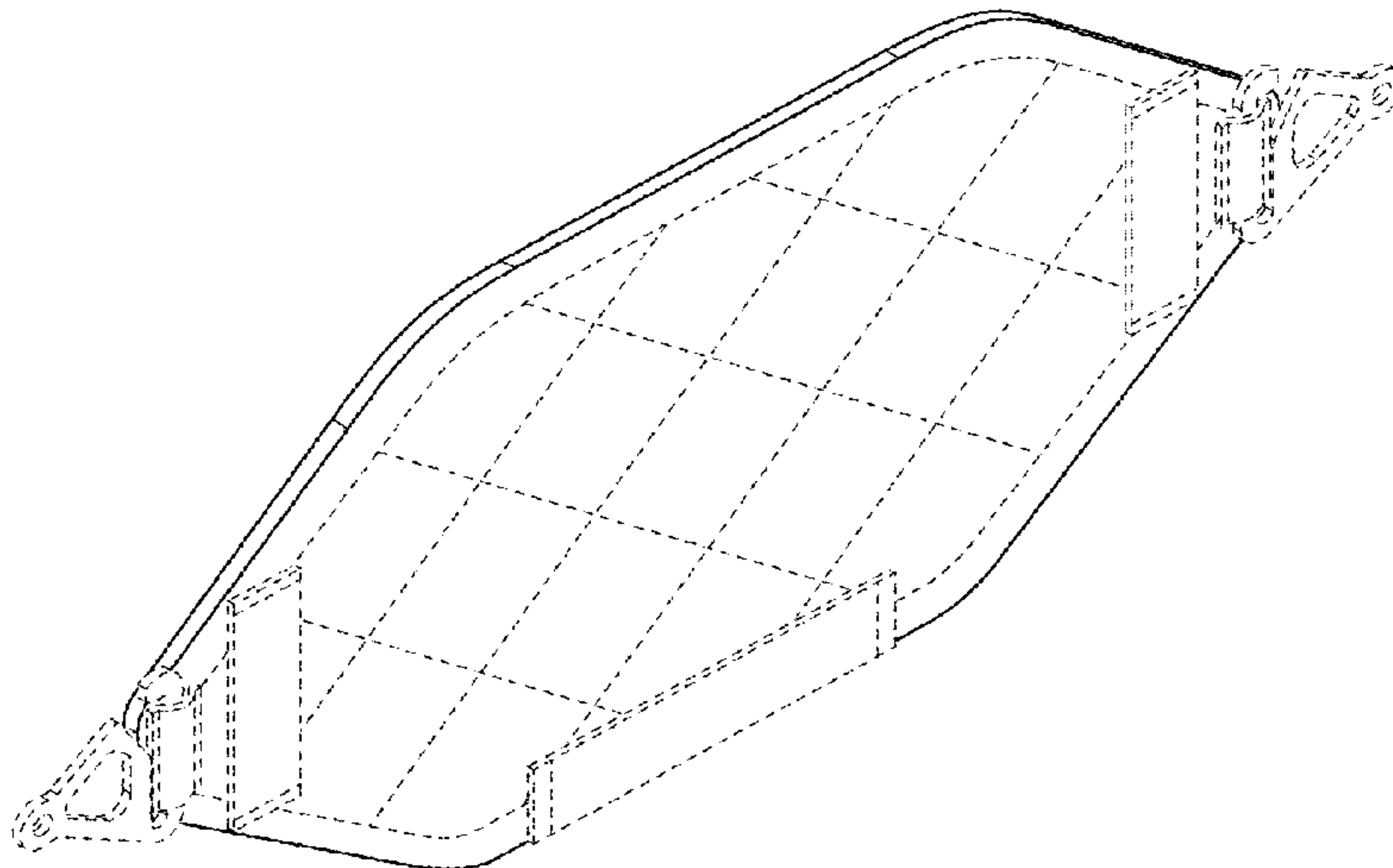

FIG. 25 is a further left side view thereof, wherein the wig grip band is shown deployed on the head of a wearer; FIG. 26 is a further right side view thereof, wherein the wig grip band is shown deployed on the head of a wearer; FIG. 27 is a further top view thereof, wherein the wig grip band is shown deployed on the head of a wearer; and, FIG. 28 is a further bottom view thereof, wherein the wig grip band is shown deployed on the head of a wearer. The broken lines in FIGS. 1-28 are for the purpose of illustrating portions of the wig grip band and environmental structure that form no part of the claimed design.

1 Claim, 14 Drawing Sheets

(58) **Field of Classification Search**

CPC ... A41G 3/00; A41G 5/00; A41G 5/04; A41G 5/0046; A41G 5/0053; A41G 5/006; A41G 5/0066; A41G 5/0073

See application file for complete search history.

(56) **References Cited**

U.S. PATENT DOCUMENTS

5,592,957	A *	1/1997	Gazerro	A41G 3/00	132/201
D413,710	S *	9/1999	De Rugeriis	D2/894	
D494,711	S	8/2004	LeBow		
8,186,361	B2 *	5/2012	Hampton	A41G 3/005	132/53
D669,633	S	10/2012	Hedgren		
D712,094	S	8/2014	Branson		
D742,072	S *	10/2015	Dixon-Miller	D28/92	
9,179,721	B2 *	11/2015	Hines	A41G 3/0008	
D746,516	S	12/2015	Cardello et al.		
D752,815	S	3/2016	Cardello et al.		
D873,493	S	1/2020	Geisinsky et al.		
D879,382	S	3/2020	Ning		
D893,104	S	8/2020	Ning		
D895,900	S	9/2020	Ning		
2014/0116456	A1 *	5/2014	Palmer-Rogers	A41G 3/0041	132/53

FOREIGN PATENT DOCUMENTS

CN	305501285	S	12/2019
CN	305506412	S	12/2019
CN	306114724	S	10/2020

GB	4035095		4/2014
GB	6019169		9/2017
GB	6019170		9/2017
GB	6019171		9/2017
GB	6019173		9/2017
JP	D1088632		8/2000
JP	D1337804		7/2008
JP	D1337806		7/2008
JP	D1337807		7/2008
JP	D1338290		7/2008
JP	D1379926		1/2010
JP	D1391781		6/2010
JP	D1586936		9/2017
KR	3002983000000		5/2002
KR	3006686140001		11/2012
KR	3009413800000		1/2018
KR	3009413830000		1/2018
KR	3009413840000		1/2018
KR	3009417980000		1/2018
WO	DM/094688		11/2016

OTHER PUBLICATIONS

Title: Milano collection lace WiGrip velvet comfort wig grip band for lace wigs and frontals with reinforced swiss lace by hairline and part; URL: <https://www.mcwigs.com/lacegrip.html> ; Accessed date: Feb. 5, 2021.

Title: Transparent lace wig grip headband adjustable wig cap wig making wig holding supplies, hat 5pcs free shipping; URL: https://pl.aliexpress.com/item/4000108829529.html?spm=a2g17.search0303.349.1ae43090jeJwhL&ws_ab_test=searchweb0_0,searchweb201602_0,searchweb201603_0,ppcSwitch_0&algo_pvid=d3f08af5-5fca-47bd-b2cb-4564f921c2ce&algo_expid=d3f08af5-5fca-47bd-b2cb-4564f921c2ce-6 ; Accessed date: Feb. 5, 2021.

Title: U Part Wig Caps With Lace Net For Making Wigs With Adjustable Straps; URL: <https://in.pinterest.com/pin/630644754049080146/> ; Accessed date: Feb. 5, 2021.

Title: New arrival velvet wig grip wig band with adjustable strap beige colour; URL: <https://www.ebay.com/itm/New-arrival-Velvet-Wig-Grip-Wig-Band-with-adjustable-strap-beige-colour-/123953494368> ; Accessed date: Feb. 5, 2021.

Title: GEX wig grip band adjustable wig comfort band headband flexible velvet scarf wig comfort non-slip adjustable fasten new design wig bands with arch extra hold for women (Brown); URL: <https://www.ubuy.co.in/search/index/view/product/B07VMCPYBY/s/gex-wig-grip-band-adjustable-wig-comfort-band-headband-flexible-velvet-scarf-wig-comfort-non-slip-adjustable-fasten-new-design-wig-bands-with-arch-extra-hold-for-women-brown/store/store/kk/dp> ; Accessed date: Feb. 5, 2021.

* cited by examiner

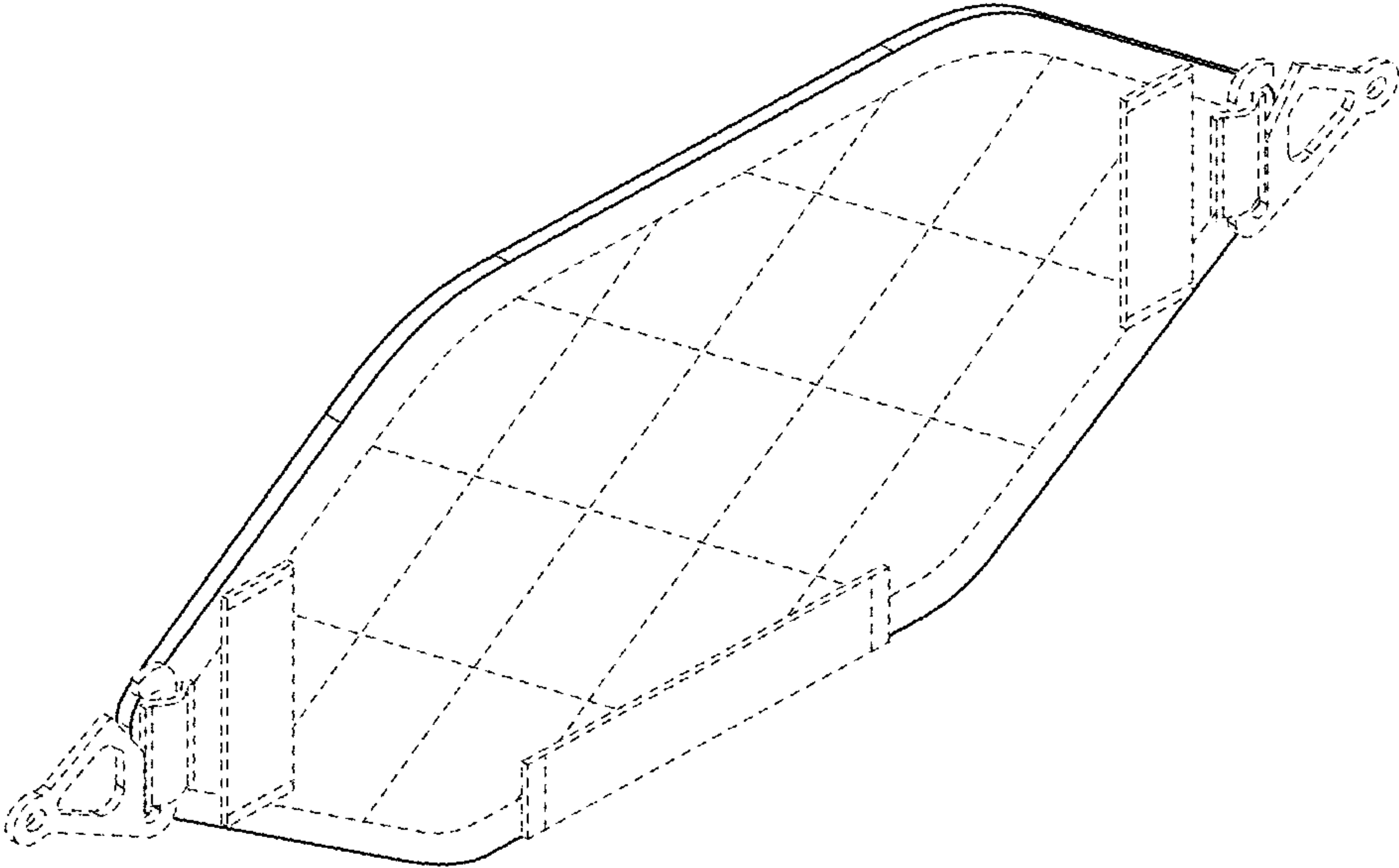

FIG. 1

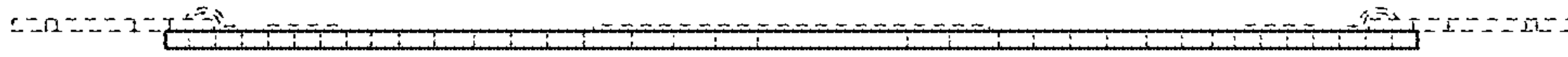

FIG. 2

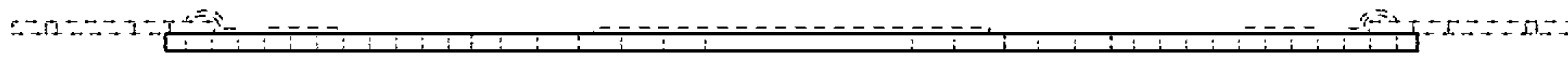

FIG. 3

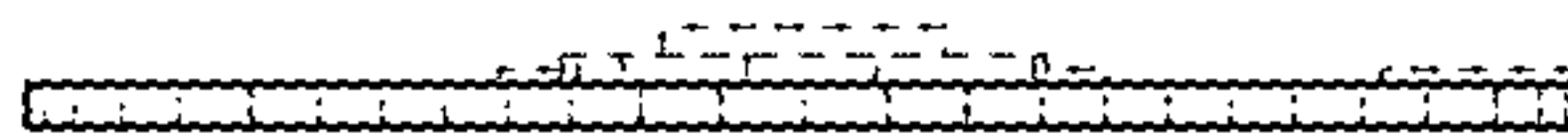

FIG. 4

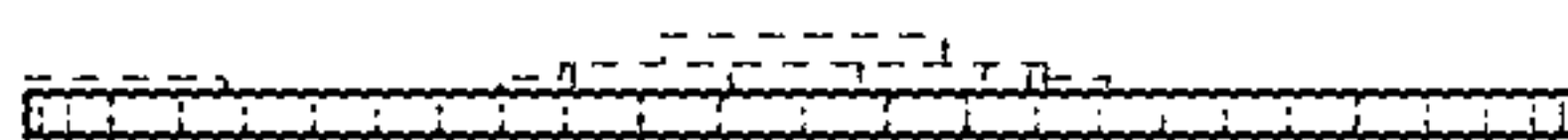

FIG. 5

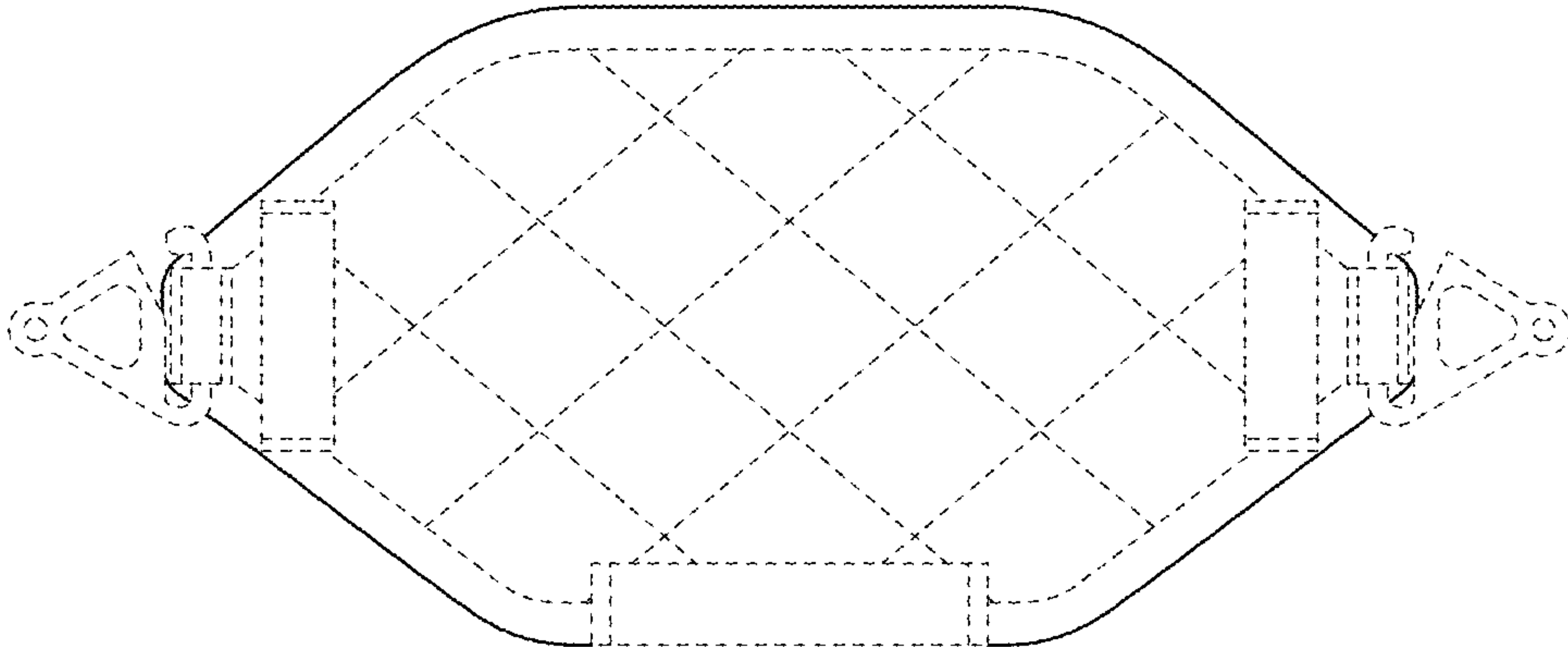

FIG. 6

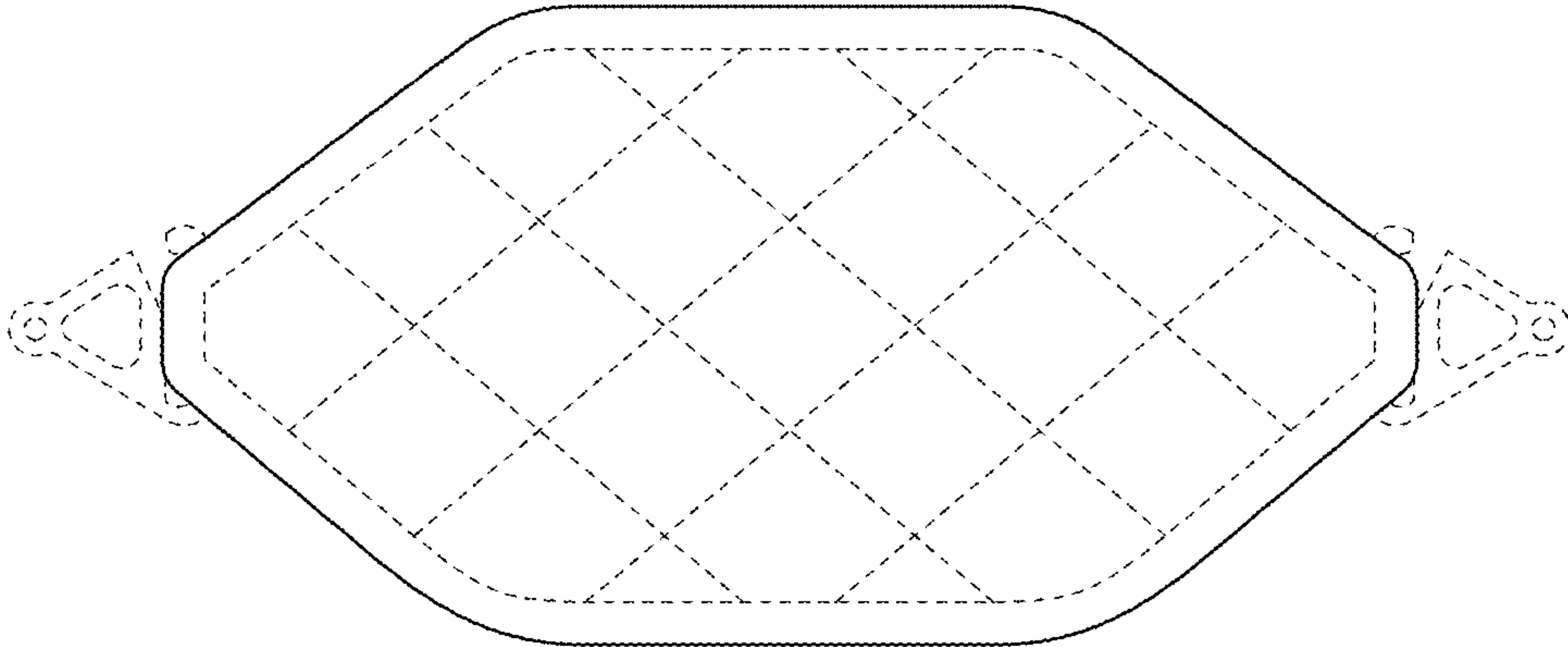

FIG. 7

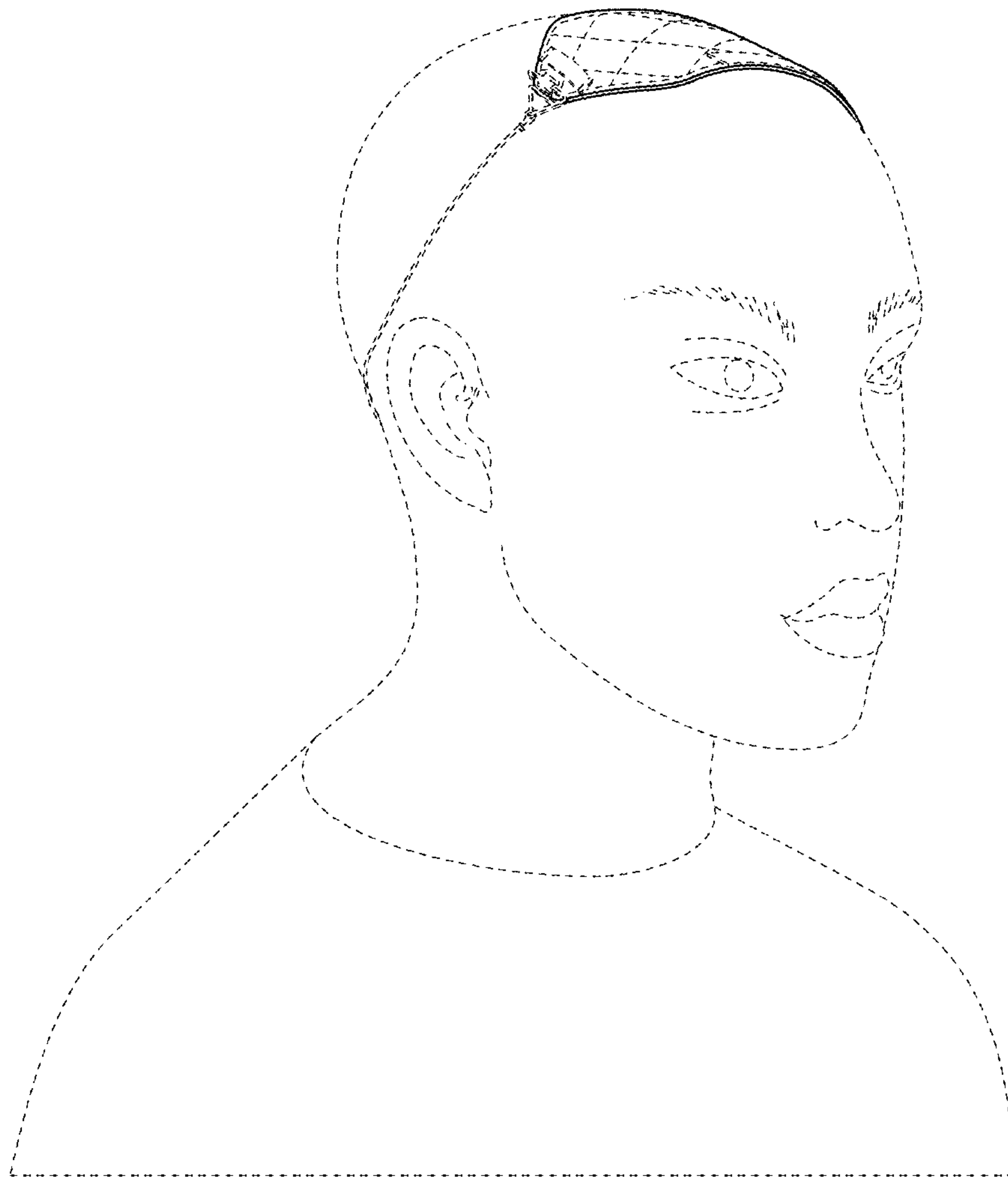

FIG. 8

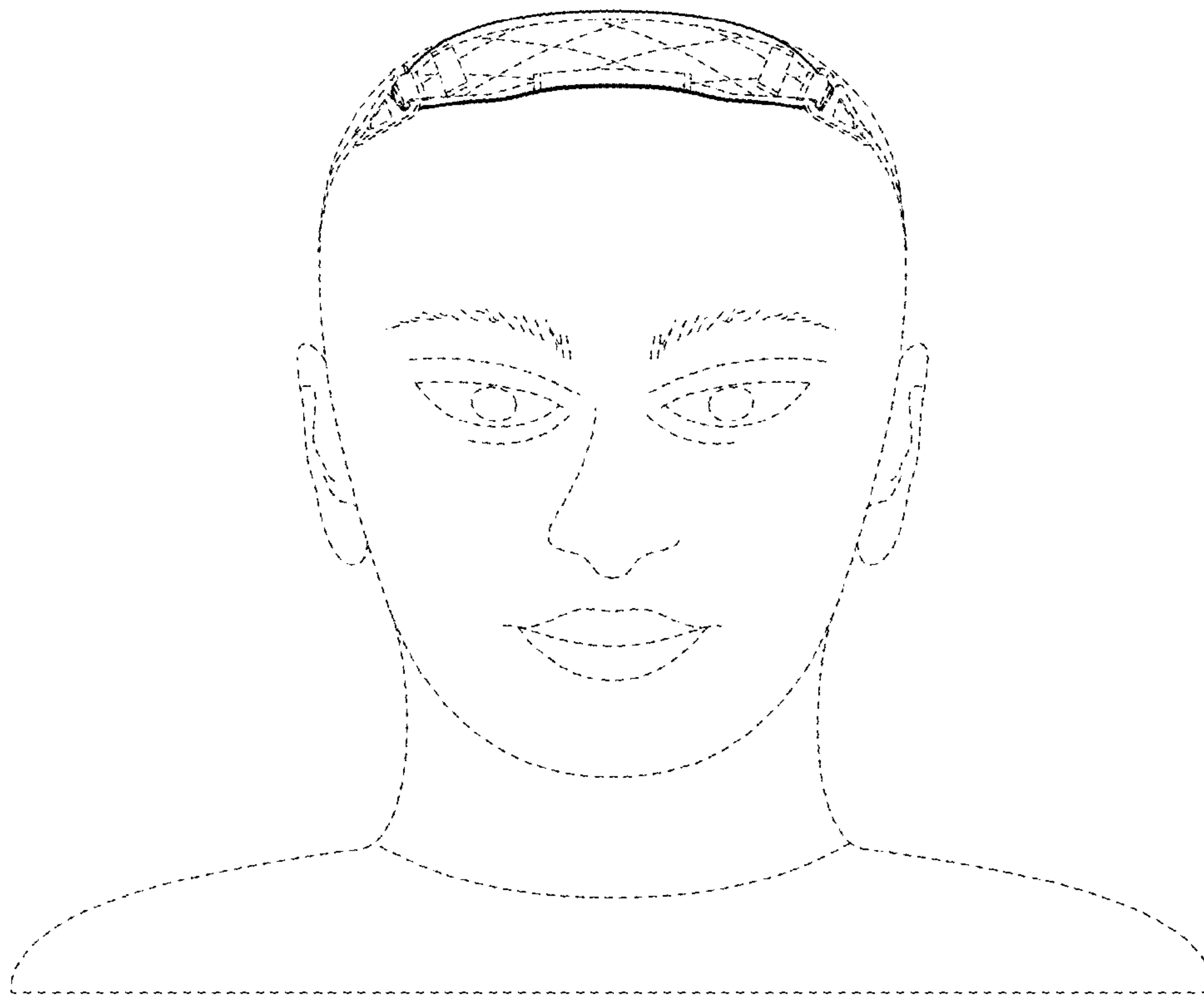

FIG. 9

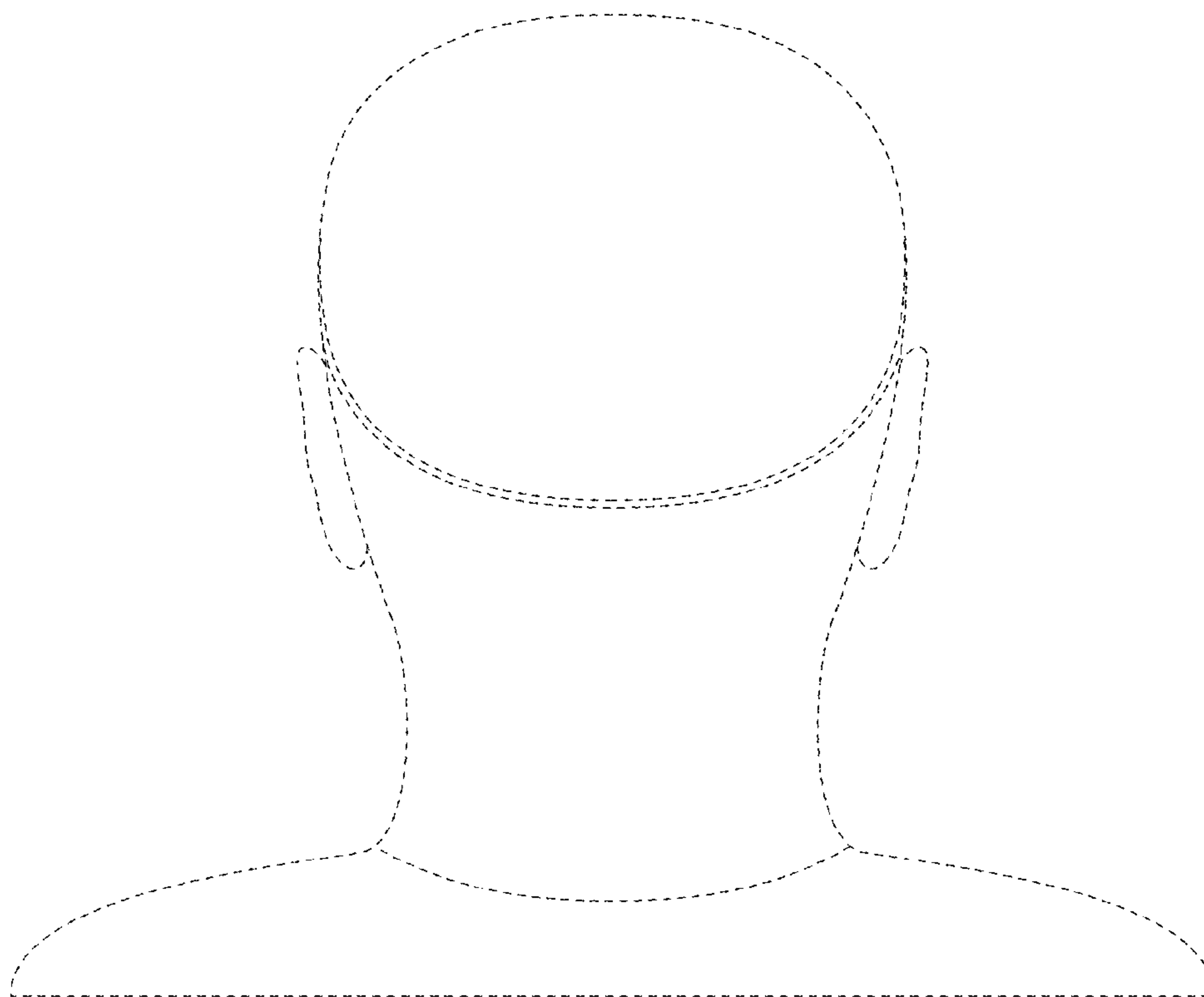

FIG. 10

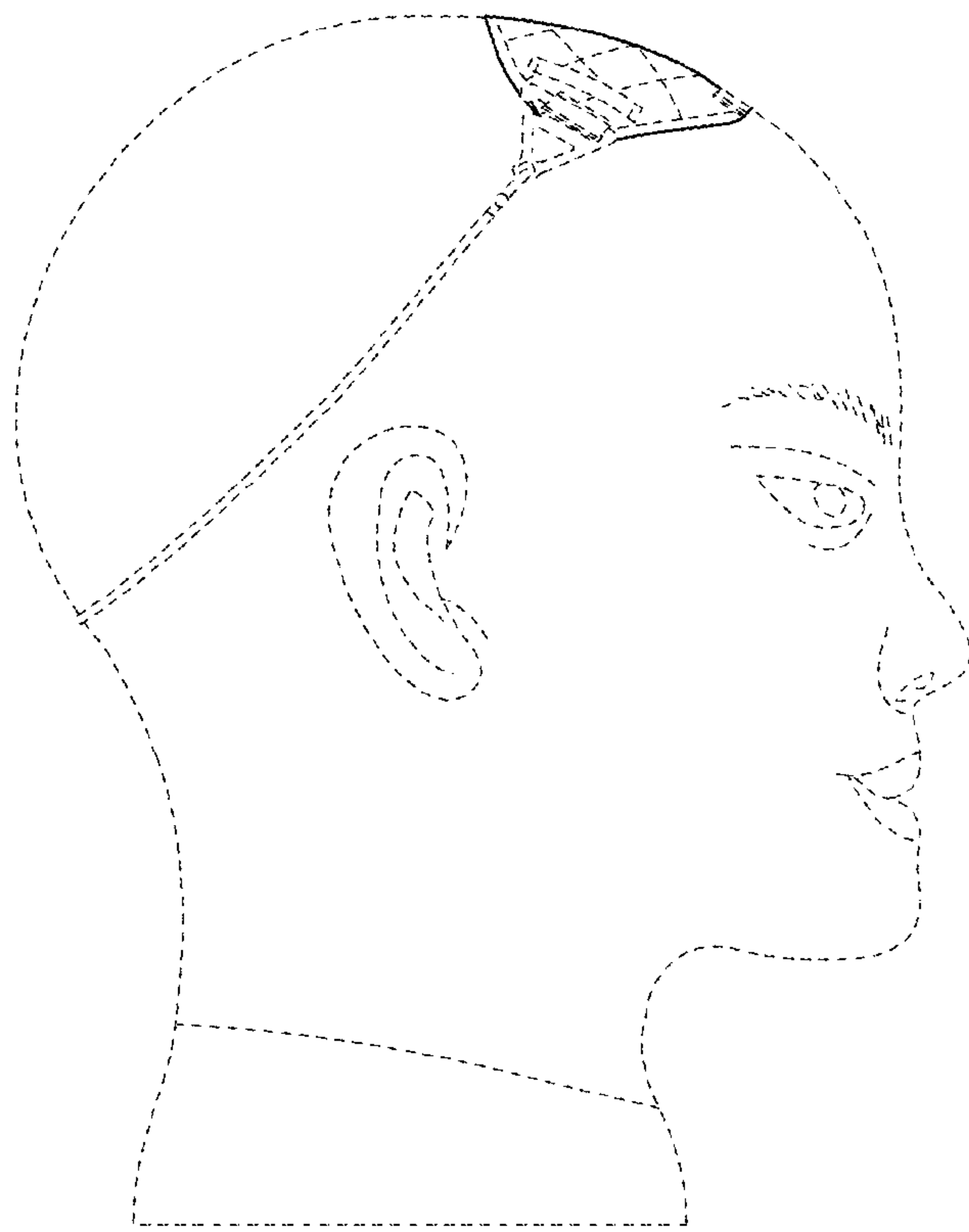

FIG. 11

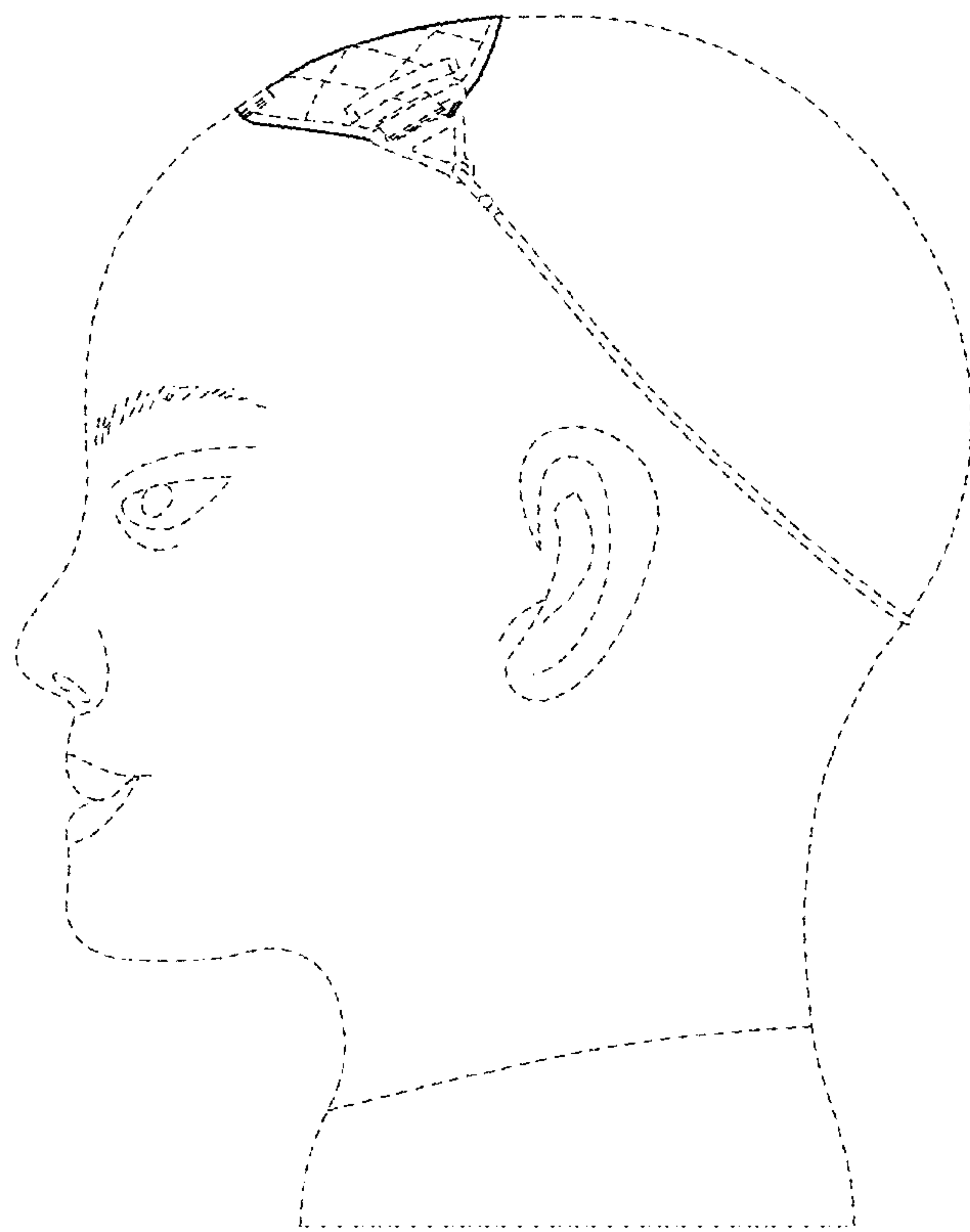

FIG. 12

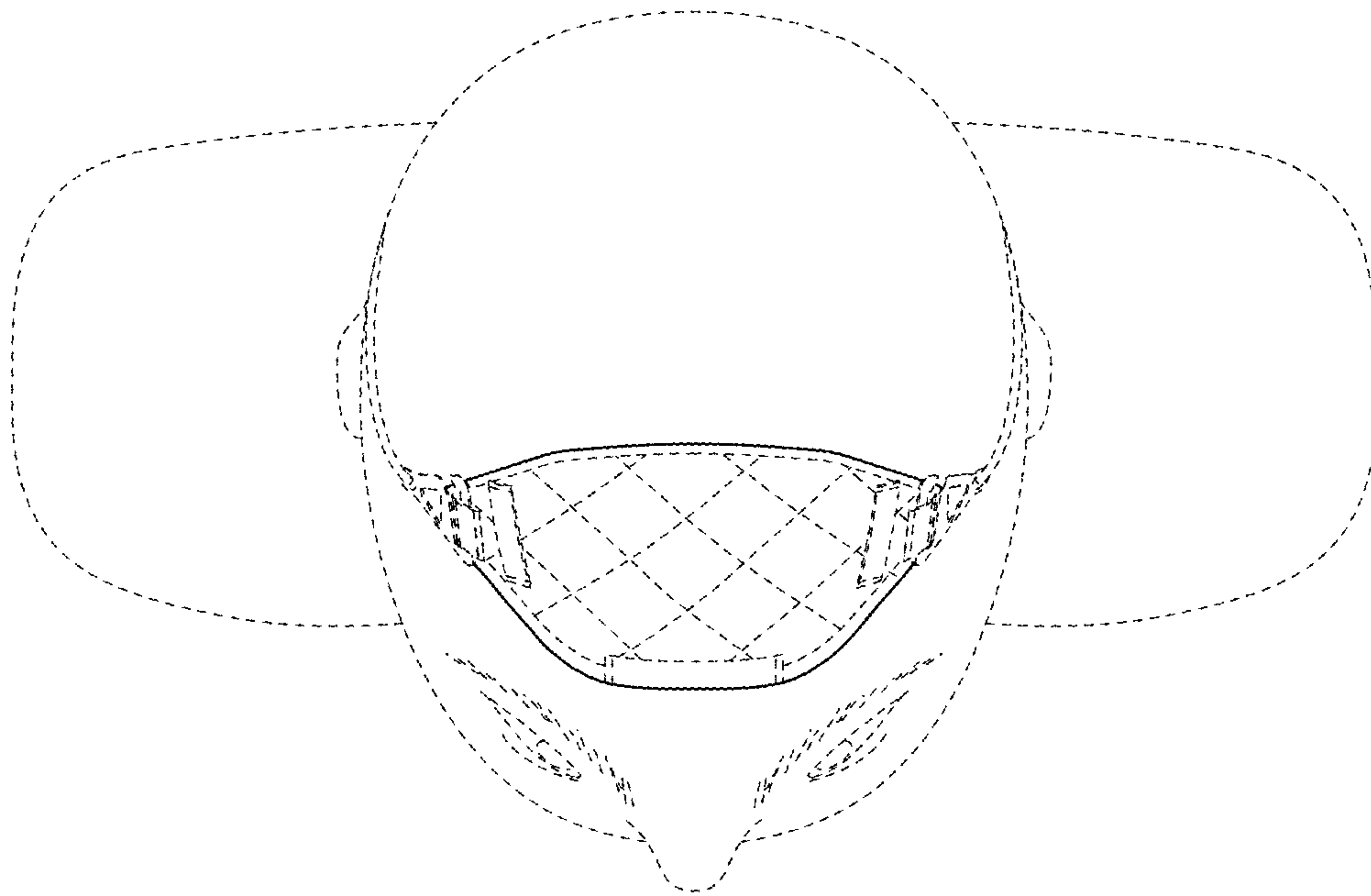

FIG. 13

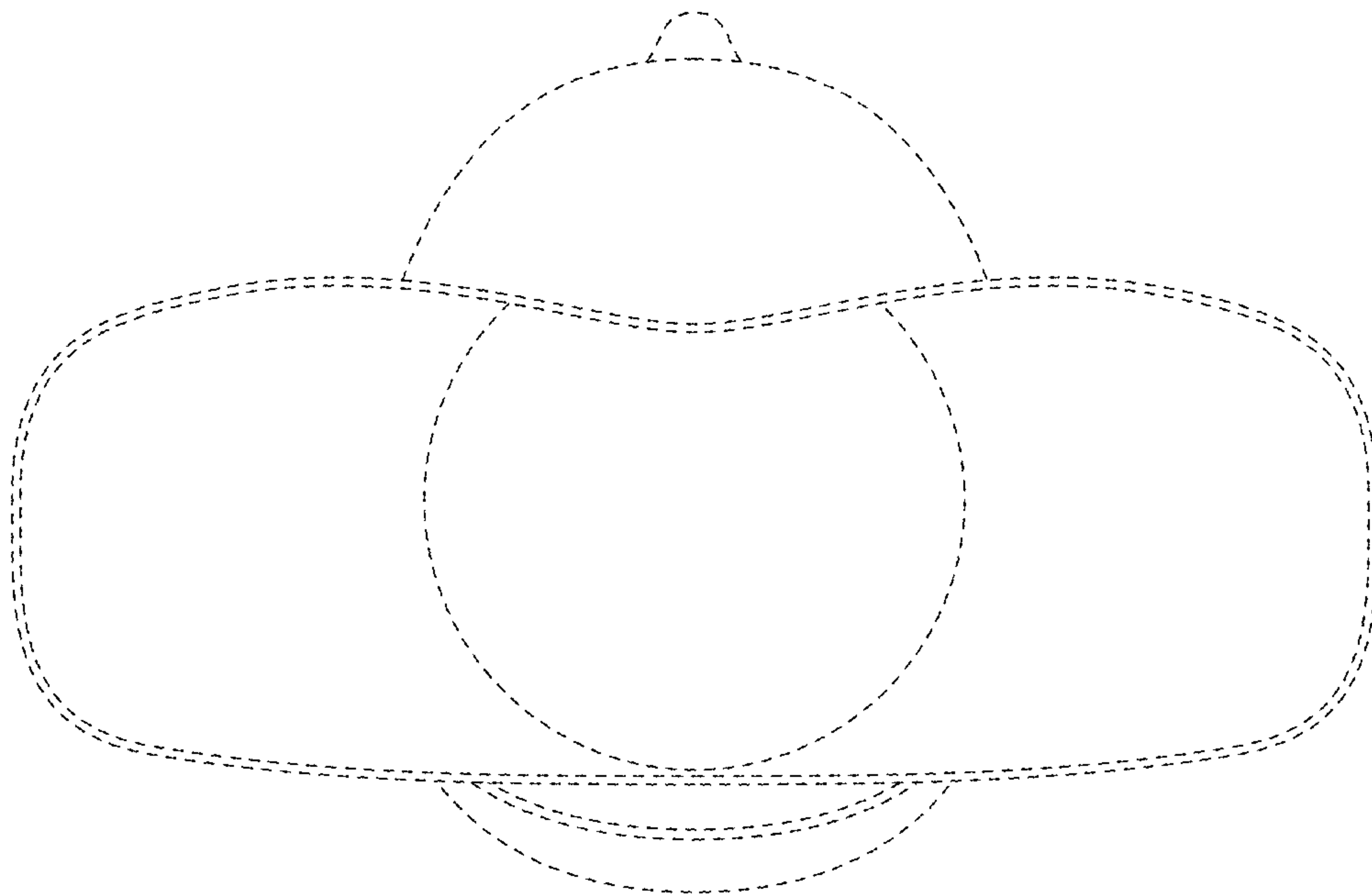

FIG. 14

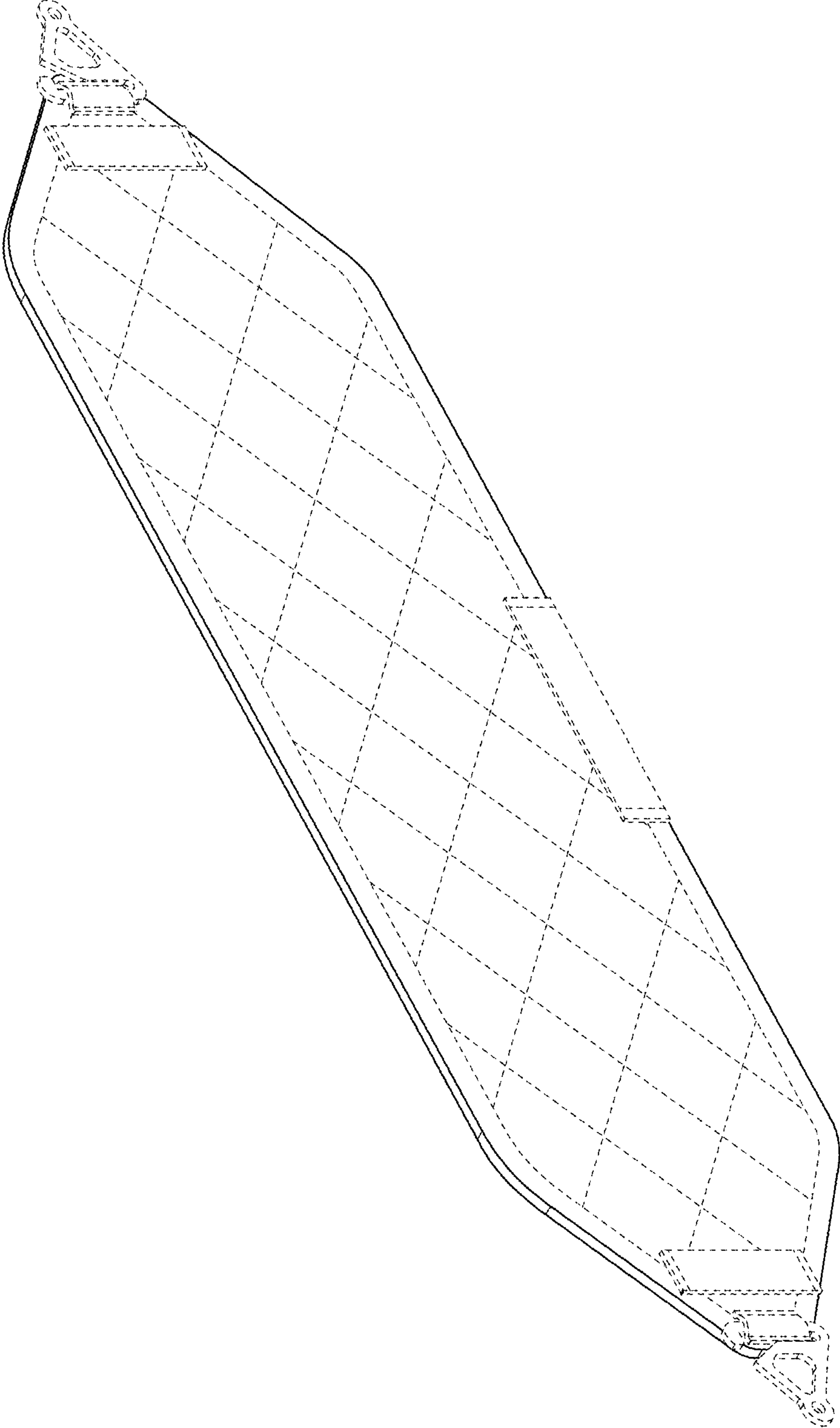

FIG. 15

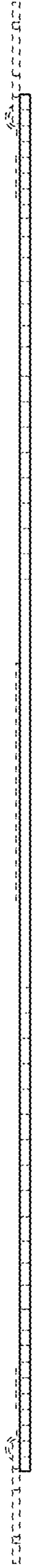

FIG. 16

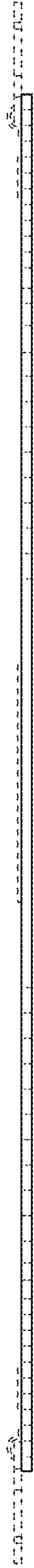

FIG. 17



FIG. 18

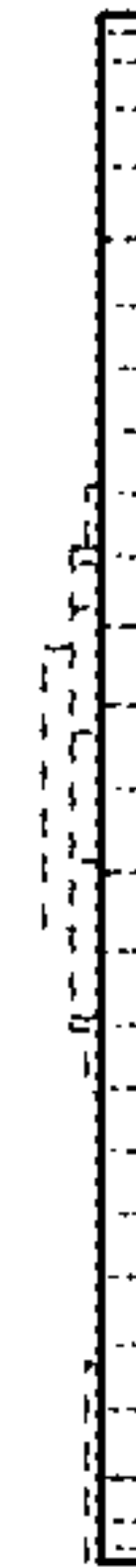

FIG. 19

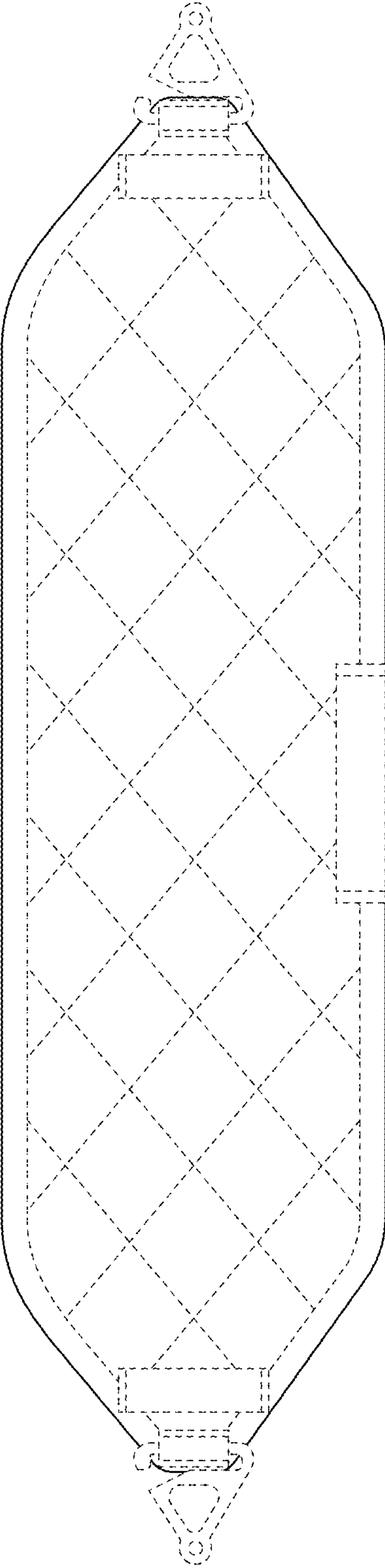

FIG. 20

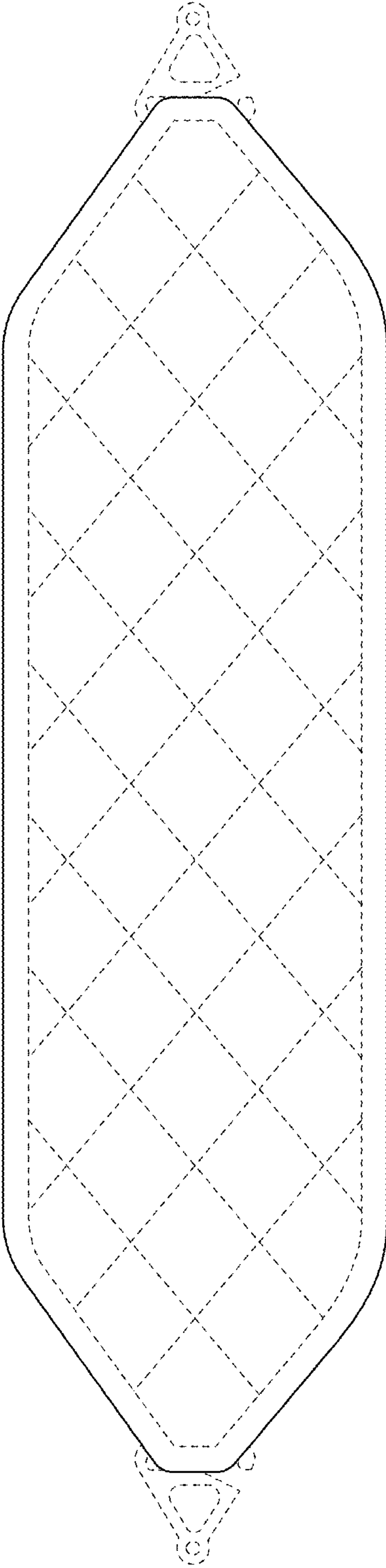

FIG. 21

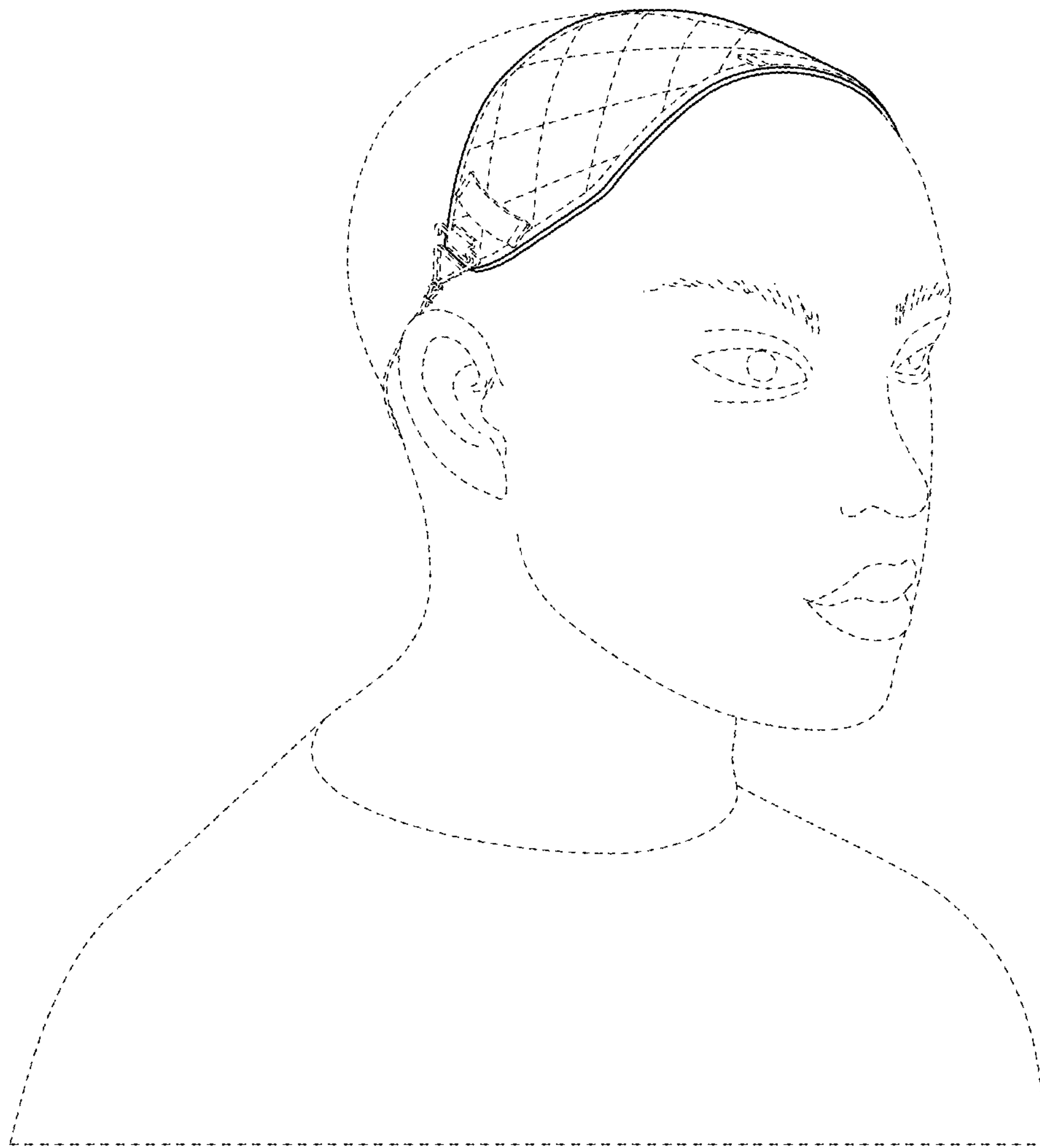

FIG. 22

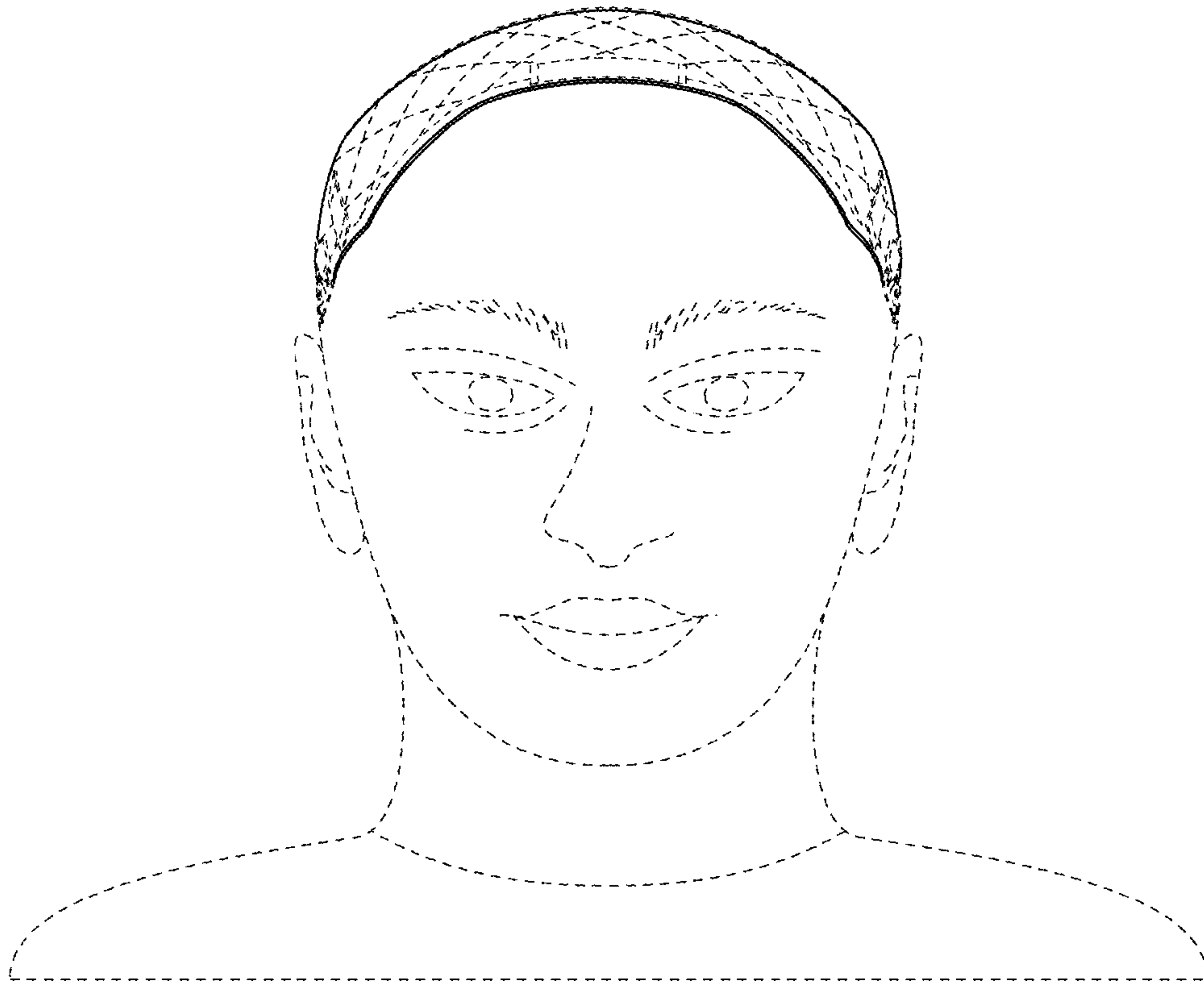

FIG.23

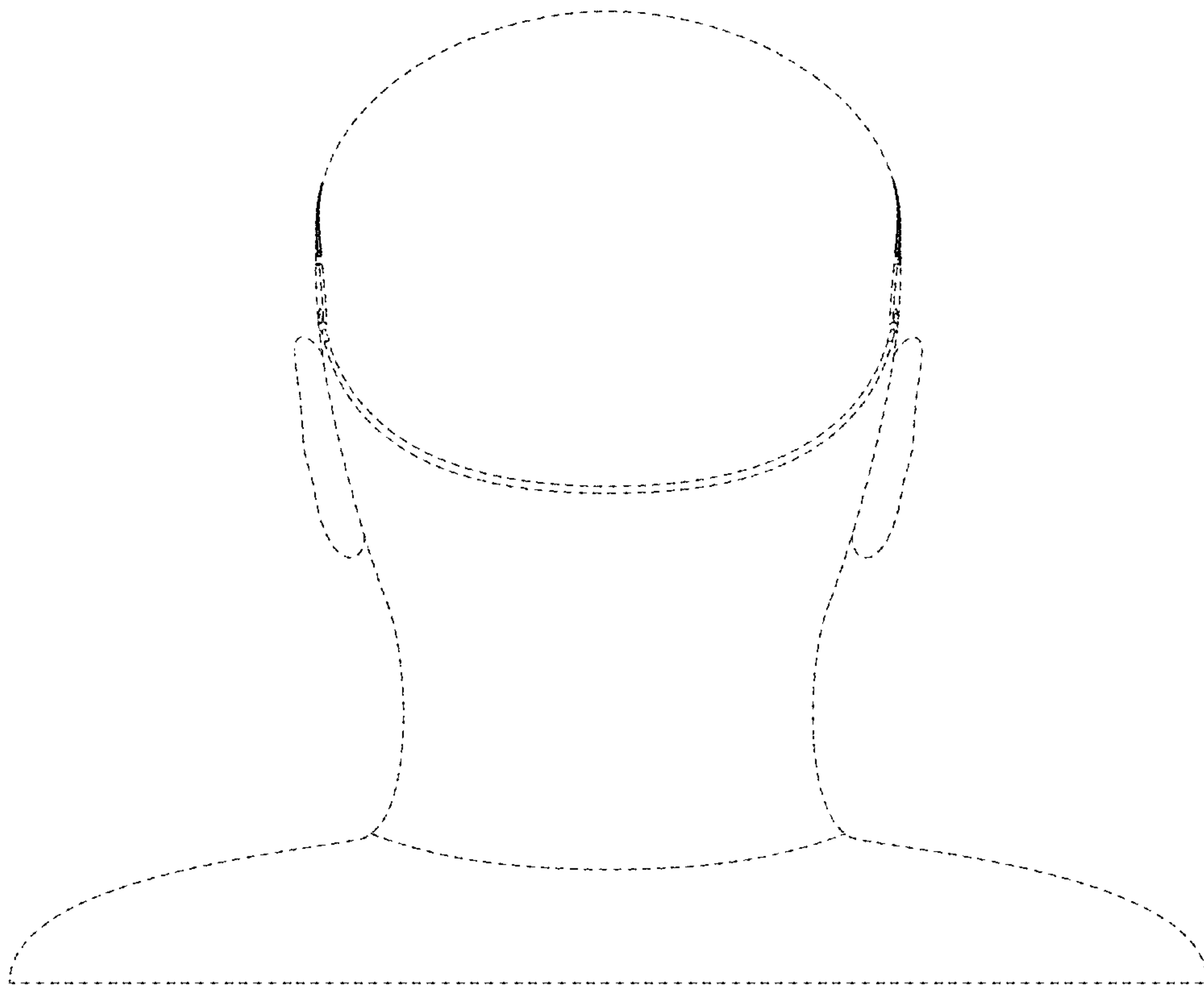

FIG.24

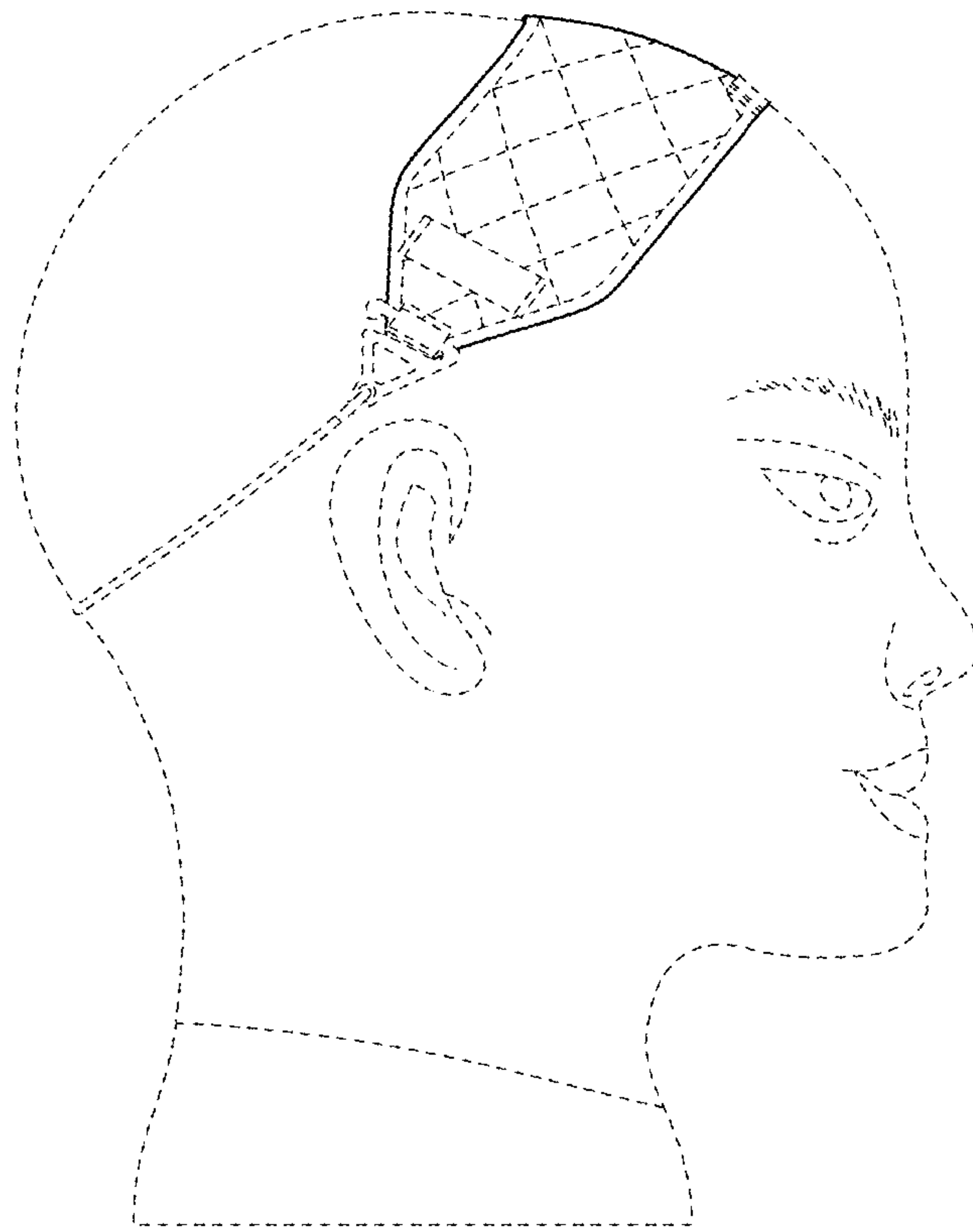

FIG. 25

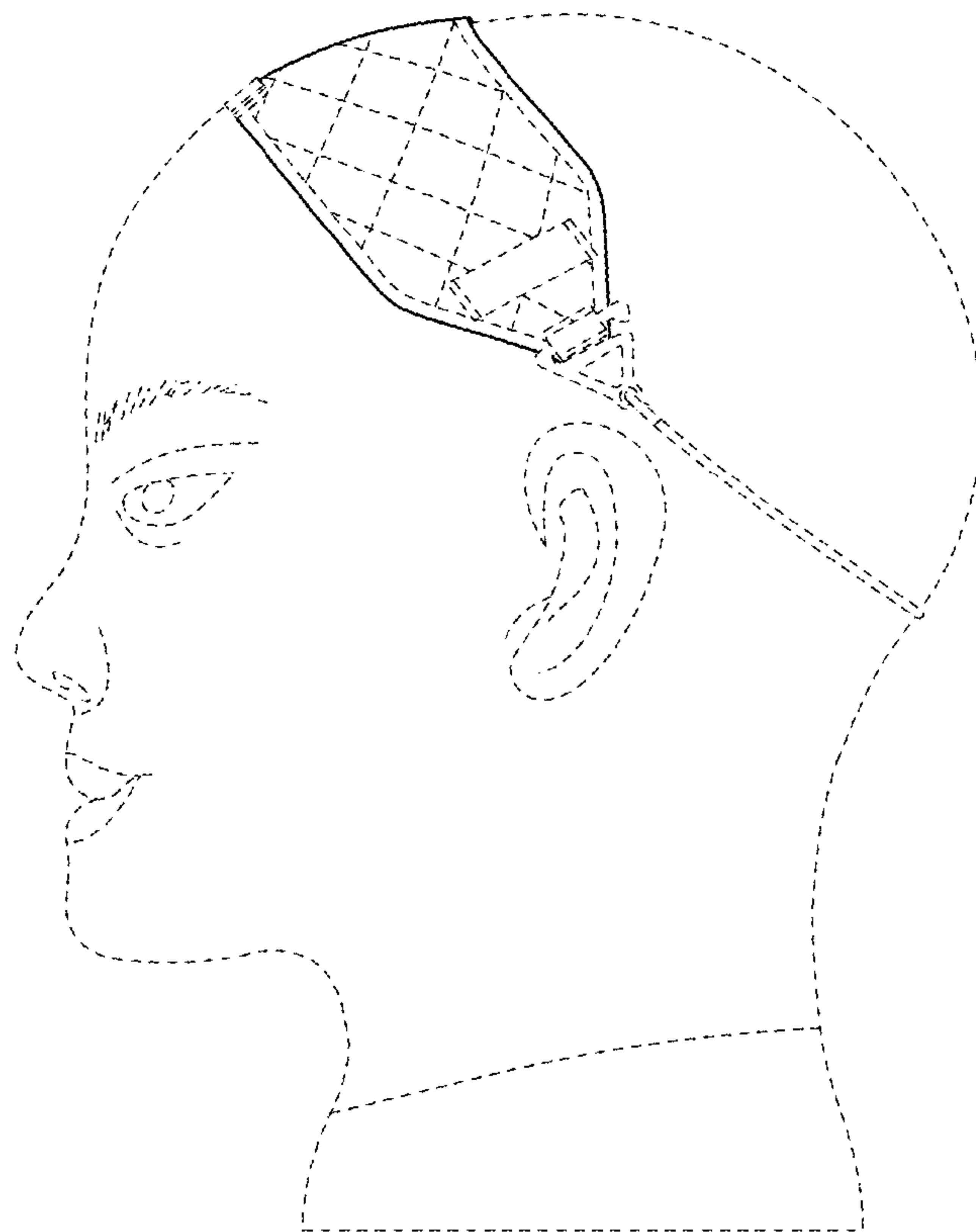

FIG. 26

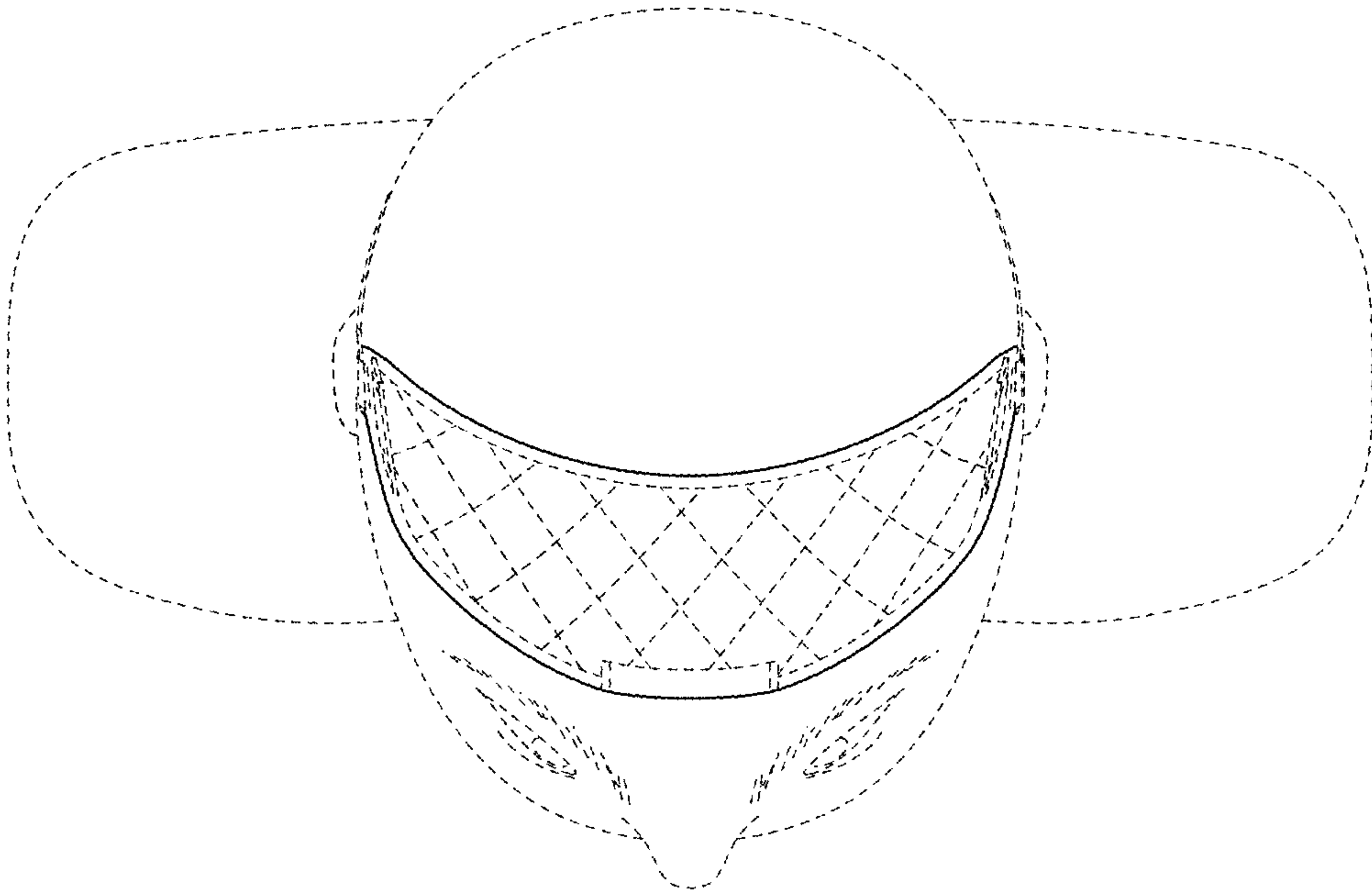

FIG. 27

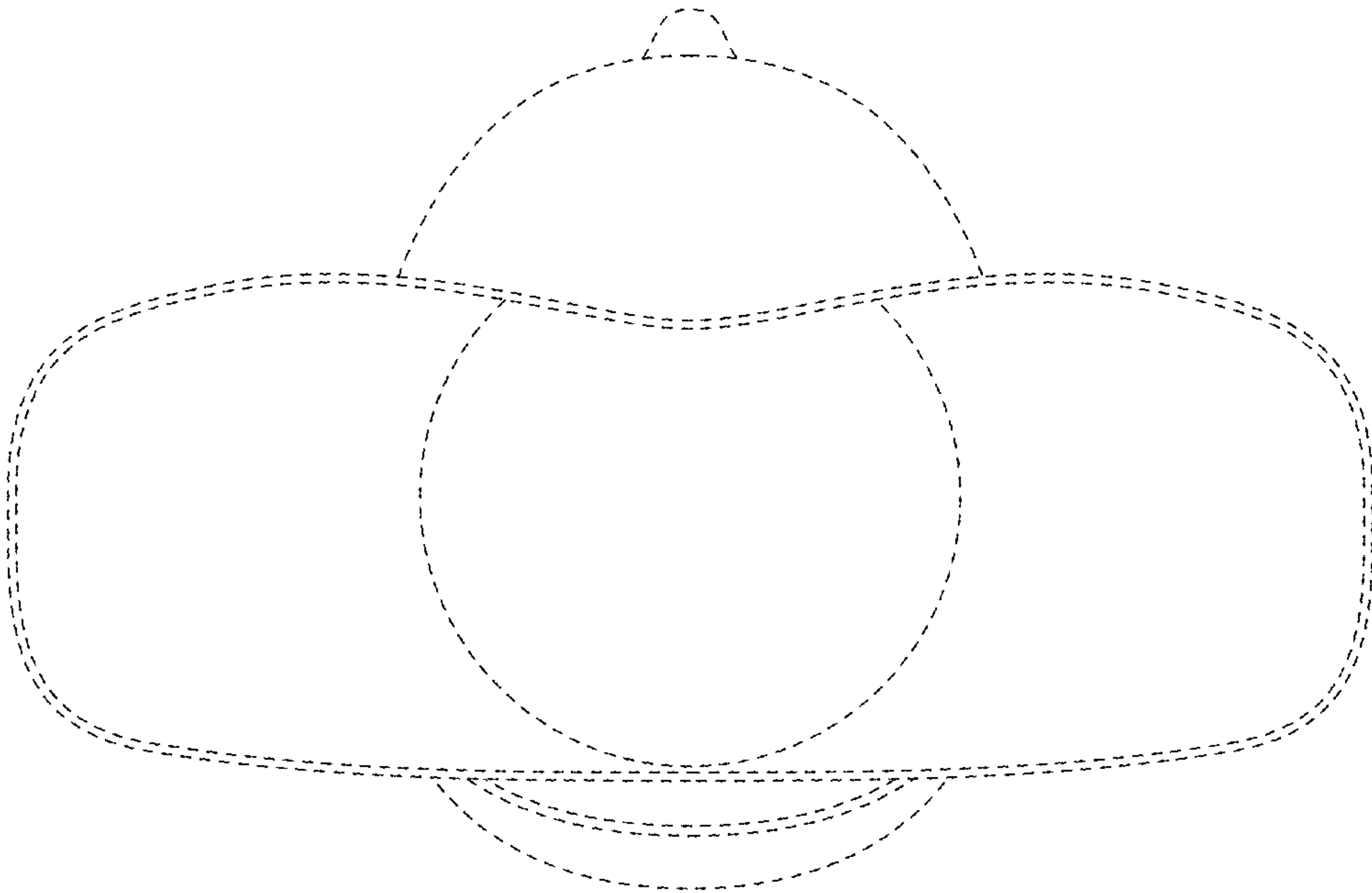

FIG. 28