



US00D939119S

(12) **United States Design Patent** (10) **Patent No.:** **US D939,119 S**
Ko (45) **Date of Patent:** **** Dec. 21, 2021**

(54) **LAMP FOR A VEHICLE**

(56) **References Cited**

(71) Applicants: **VISION X ASIA CO., LTD.**,
Hwaseong-si (KR); **In Hong Ko**, Seoul
(KR)

U.S. PATENT DOCUMENTS

D499,198 S	*	11/2004	Cowan	D26/31
D526,430 S	*	8/2006	Hernandez	D26/31
D576,754 S	*	9/2008	Wang	D26/31
D653,783 S	*	2/2012	Biro	D26/31
D676,990 S	*	2/2013	Adams	D26/31

(72) Inventor: **In Hong Ko**, Seoul (KR)

* cited by examiner

(73) Assignee: **VISION X ASIA CO., LTD.**,
Hwaseong-si (KR)

Primary Examiner — Marcus A Jackson

(**) Term: **15 Years**

(74) *Attorney, Agent, or Firm* — Cantor Colburn LLP

(21) Appl. No.: **29/713,418**

(57) **CLAIM**

The ornamental design for a lamp for a vehicle, as shown and described.

(22) Filed: **Nov. 15, 2019**

DESCRIPTION

(30) **Foreign Application Priority Data**

Sep. 23, 2019 (KR) 30-2019-0045343

(51) **LOC (13) Cl.** **26-06**

(52) **U.S. Cl.**
USPC **D26/31**

(58) **Field of Classification Search**
USPC D26/28-36, 139
CPC F21S 48/00; F21S 48/10; F21S 48/115;
F21S 48/225; F21S 48/1233; F21S
48/1266; F21S 48/2268; F21V 21/04;
F21V 29/004; B60Q 9/13; B60Q 9/135;
B60Q 9/1375

FIG. 1 is a perspective view of a lamp for a vehicle showing my new design, with the center portion of the claimed design broken away to indicate indeterminate length;
FIG. 2 is a front elevational view thereof;
FIG. 3 is a rear elevational view thereof;
FIG. 4 is a left side elevational view thereof;
FIG. 5 is a right side elevational view thereof;
FIG. 6 is a top plan view thereof;
FIG. 7 is a bottom plan view thereof; and,
FIG. 8 is an enlarged view of portion 8 in FIG. 1.
The broken lines in the drawings are included for illustrative purposes only and form no part of the claimed design.

See application file for complete search history.

1 Claim, 3 Drawing Sheets

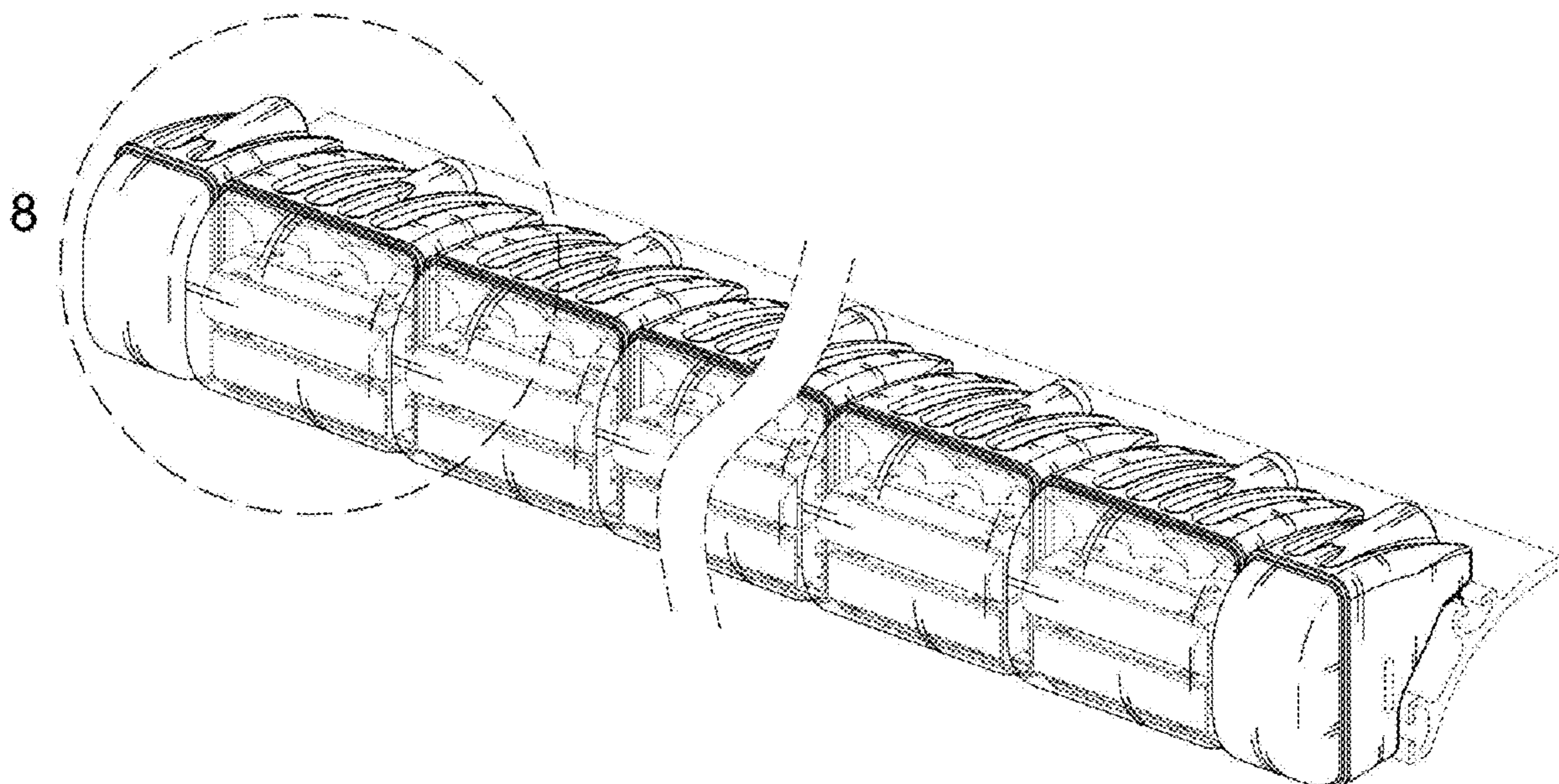

FIG. 1

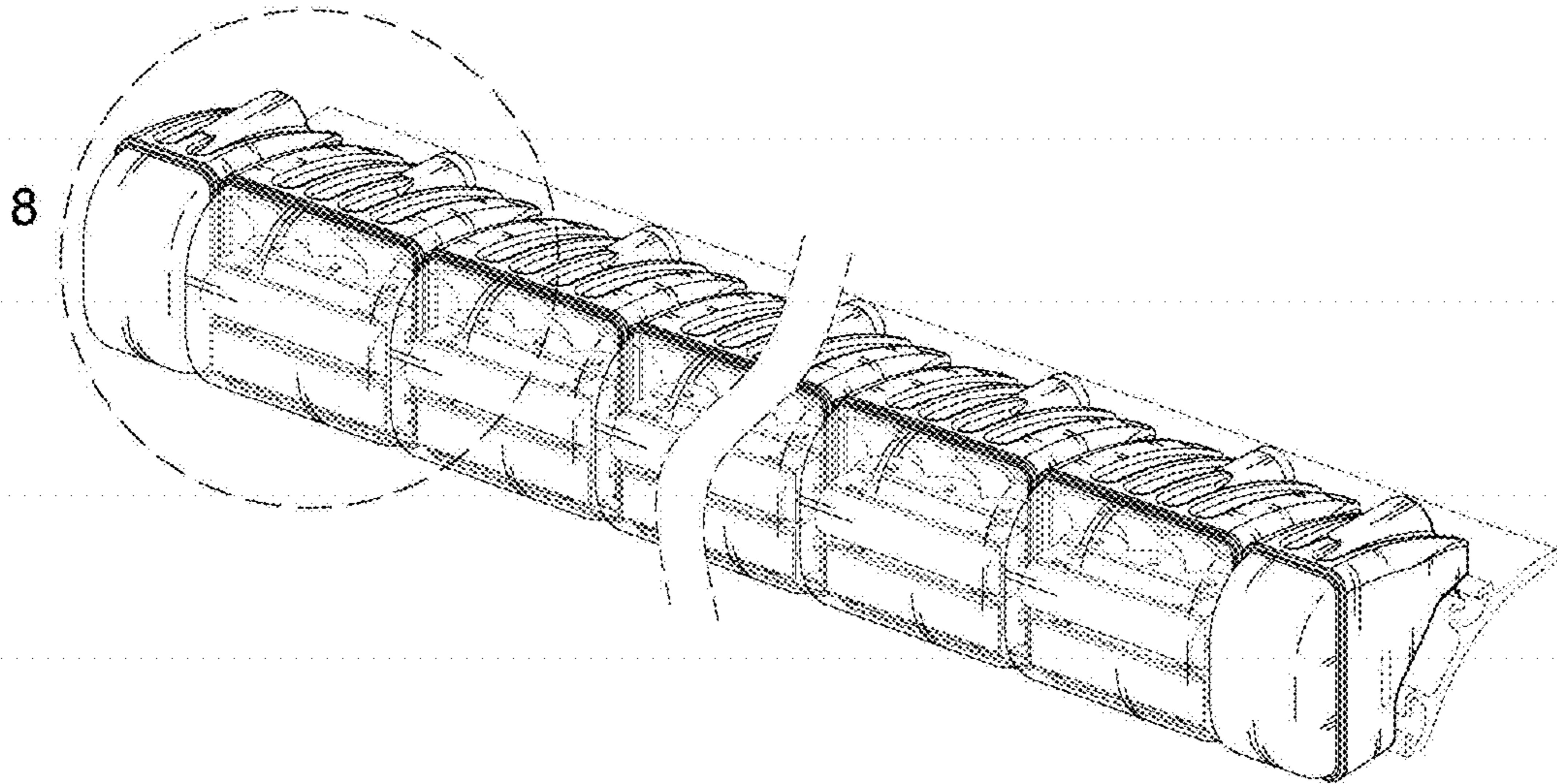

FIG. 2

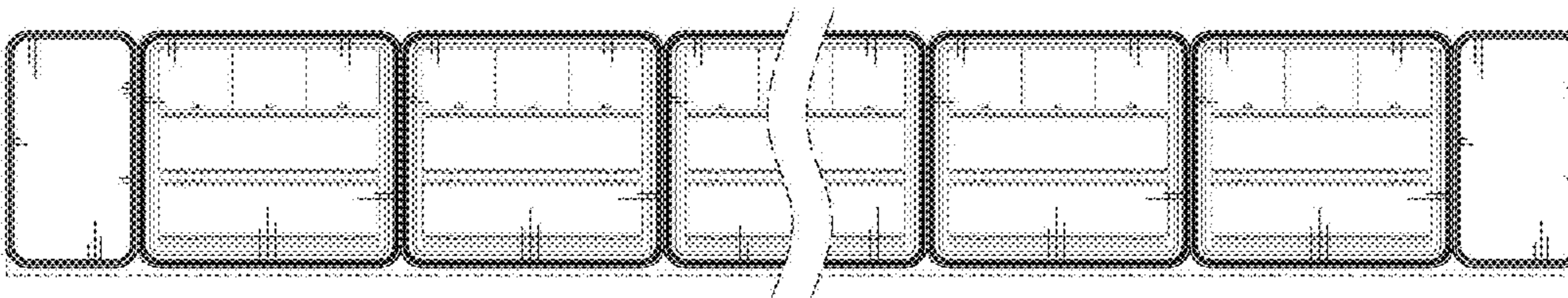

FIG. 3

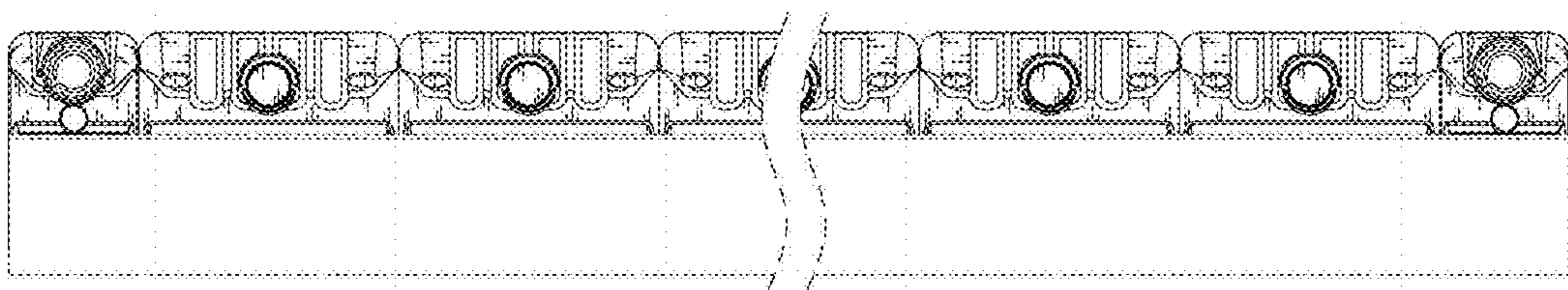

FIG. 4

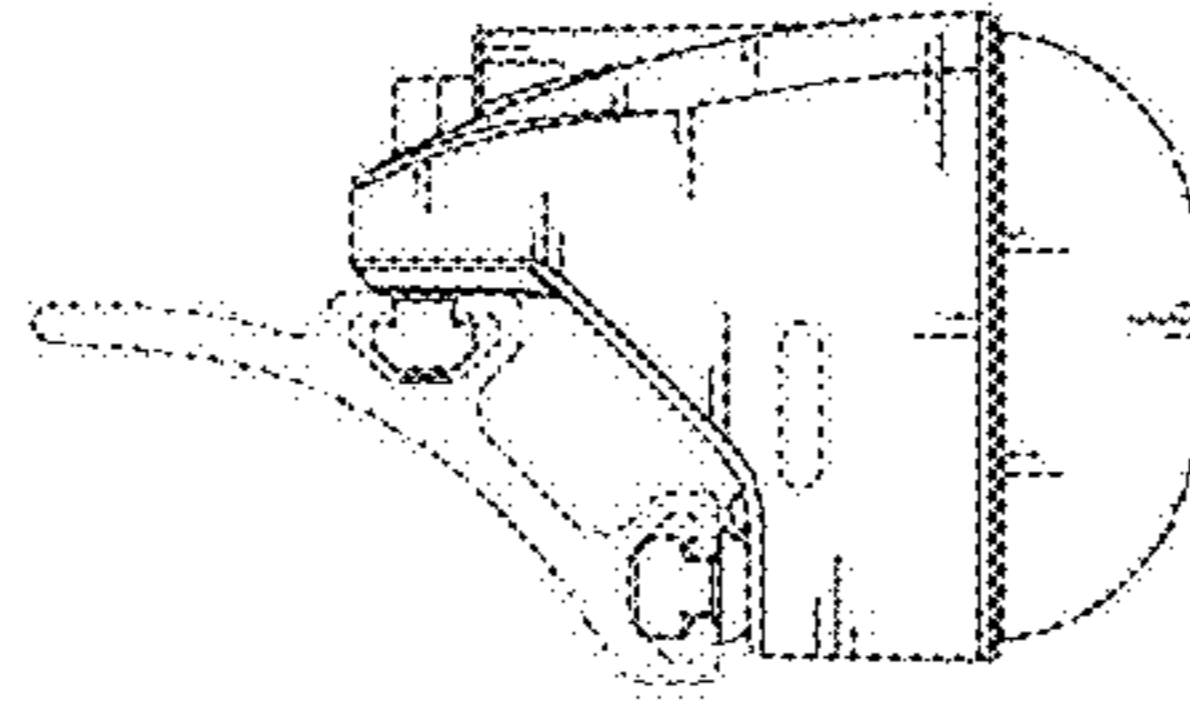

FIG. 5

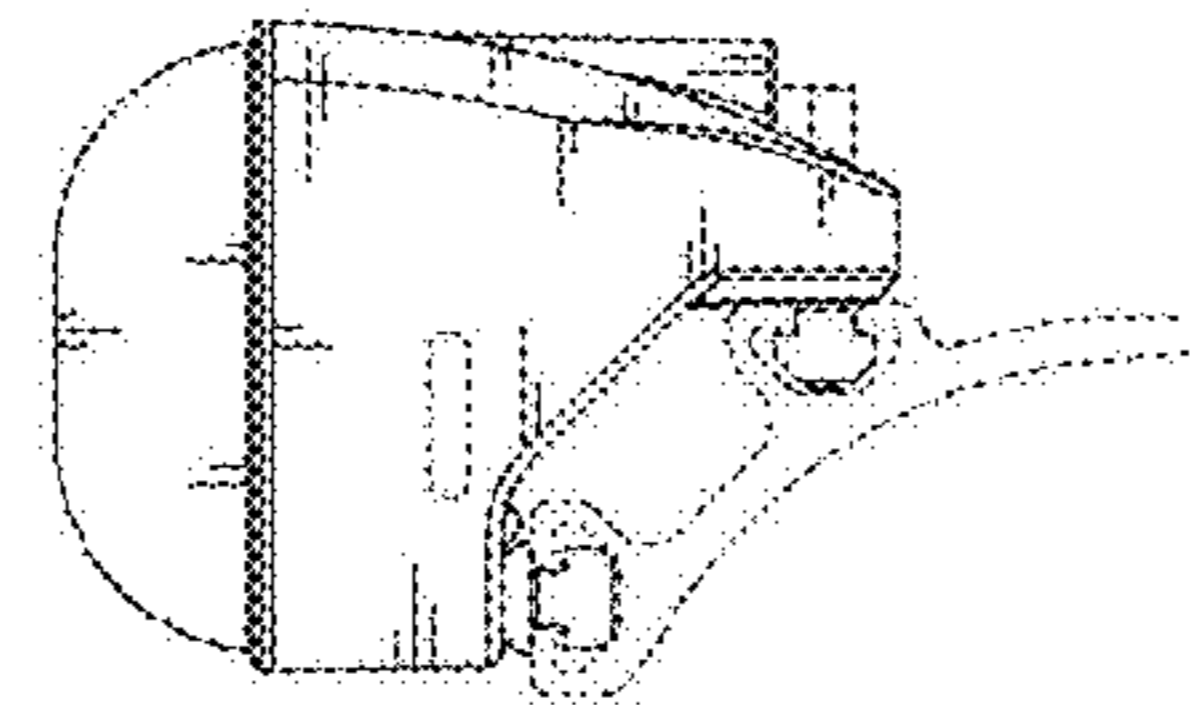

FIG. 6

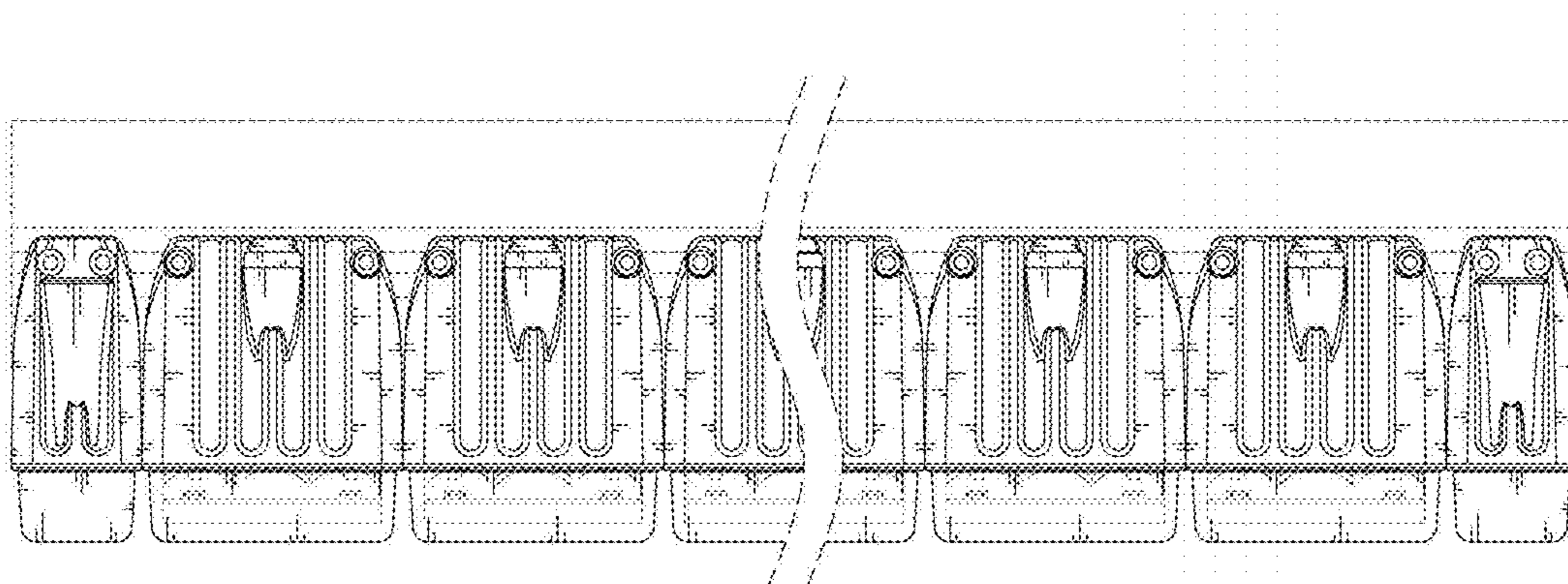

FIG. 7

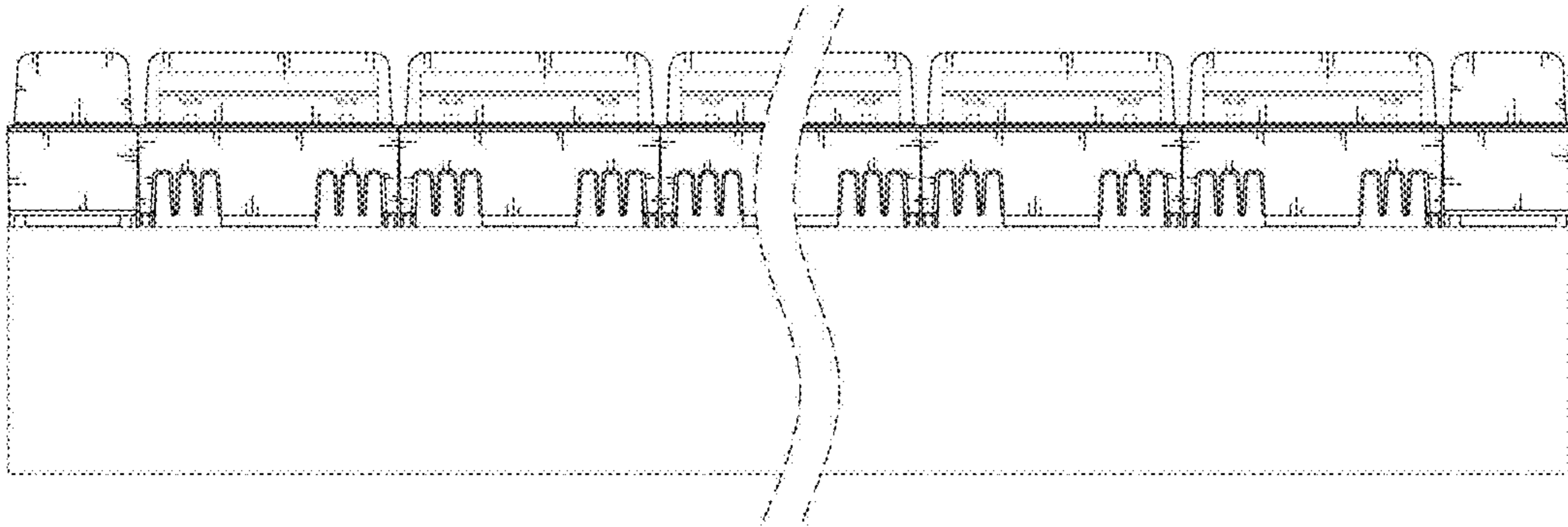

FIG. 8

