



US00D938961S

(12) **United States Design Patent** (10) **Patent No.:** **US D938,961 S**
Hui et al. (45) **Date of Patent:** **** Dec. 21, 2021**

(54) **DISPLAY SCREEN WITH GRAPHICAL USER INTERFACE**

2021]. <https://www.youtube.com/watch?v=TbPchAPRmjk> (Year: 2018).*

(71) Applicant: **GE Precision Healthcare LLC**,
Milwaukee, WI (US)

(Continued)

(72) Inventors: **Hui Hui**, Wuxi (CN); **Dan Li**, Shanghai (CN); **Chiah Huei Mian**, Shanghai (CN); **Qingyan Liu**, Wuxi (CN); **Qi Jose Wang**, Wuxi (CN)

Primary Examiner — John M Otte

(74) *Attorney, Agent, or Firm* — McCoy Russell LLP

(73) Assignee: **GE Precision Healthcare LLC**,
Milwaukee, WI (US)

(57) **CLAIM**

The ornamental design for a display screen with graphical user interface, as shown and described.

(**) Term: **15 Years**

DESCRIPTION

(21) Appl. No.: **29/701,809**

FIG. 1 is a front view of a display screen with graphical user interface shown on a monitor.

(22) Filed: **Aug. 14, 2019**

FIG. 2 is a front view of the display screen with graphical user interface shown on the monitor, with the design shown in another environment.

(51) **LOC (13) Cl.** **14-04**

(52) **U.S. Cl.**
USPC **D14/485**

(58) **Field of Classification Search**
USPC D14/485–495; D20/11; D21/324, 325
CPC G06F 3/048; G06F 3/0481; G06F 3/04817;
G06F 3/0482; G06F 3/0483; G06F
3/04842; G06F 3/0485; G06F 3/04855;
G06F 3/0486; G06F 3/0488; G06F
3/04886; G06F 9/4443; G06F 17/211;
G06F 17/212; G09G 5/14; A61M
16/0003; A61M

FIG. 3 is a rear view of the monitor.

FIG. 4 is a top view of the monitor.

FIG. 5 is a bottom view of the monitor.

FIG. 6 is a right side view of the monitor.

FIG. 7 is a left side view of the monitor.

FIG. 8 is a front view of the display screen with graphical user interface on a second monitor.

FIG. 9 is a front view of the display screen with graphical user interface shown on the second monitor, with the design shown in another environment.

FIG. 10 is a rear view of the second monitor.

FIG. 11 is a top view of the second monitor.

FIG. 12 is a bottom view of the second monitor.

FIG. 13 is a right side view of the second monitor.

FIG. 14 is a left side view of the second monitor; and,

FIG. 15 is a perspective view of the display screen with graphical user interface shown on the second monitor in a use environment.

The broken lines in the drawings illustrate portions of the display screen with graphical user interface and environmental subject matter that form no part of the claimed design.

(Continued)

(56) **References Cited**

U.S. PATENT DOCUMENTS

5,345,552 A * 9/1994 Brown G09G 5/14
345/536

D441,761 S * 5/2001 Machida D14/486
(Continued)

OTHER PUBLICATIONS

“B105 and B125 monitors—Simple. Flexible. Reliable. GE Healthcare” Feb. 1, 2018, posted at youtube.com, [site visited Apr. 22,

1 Claim, 15 Drawing Sheets

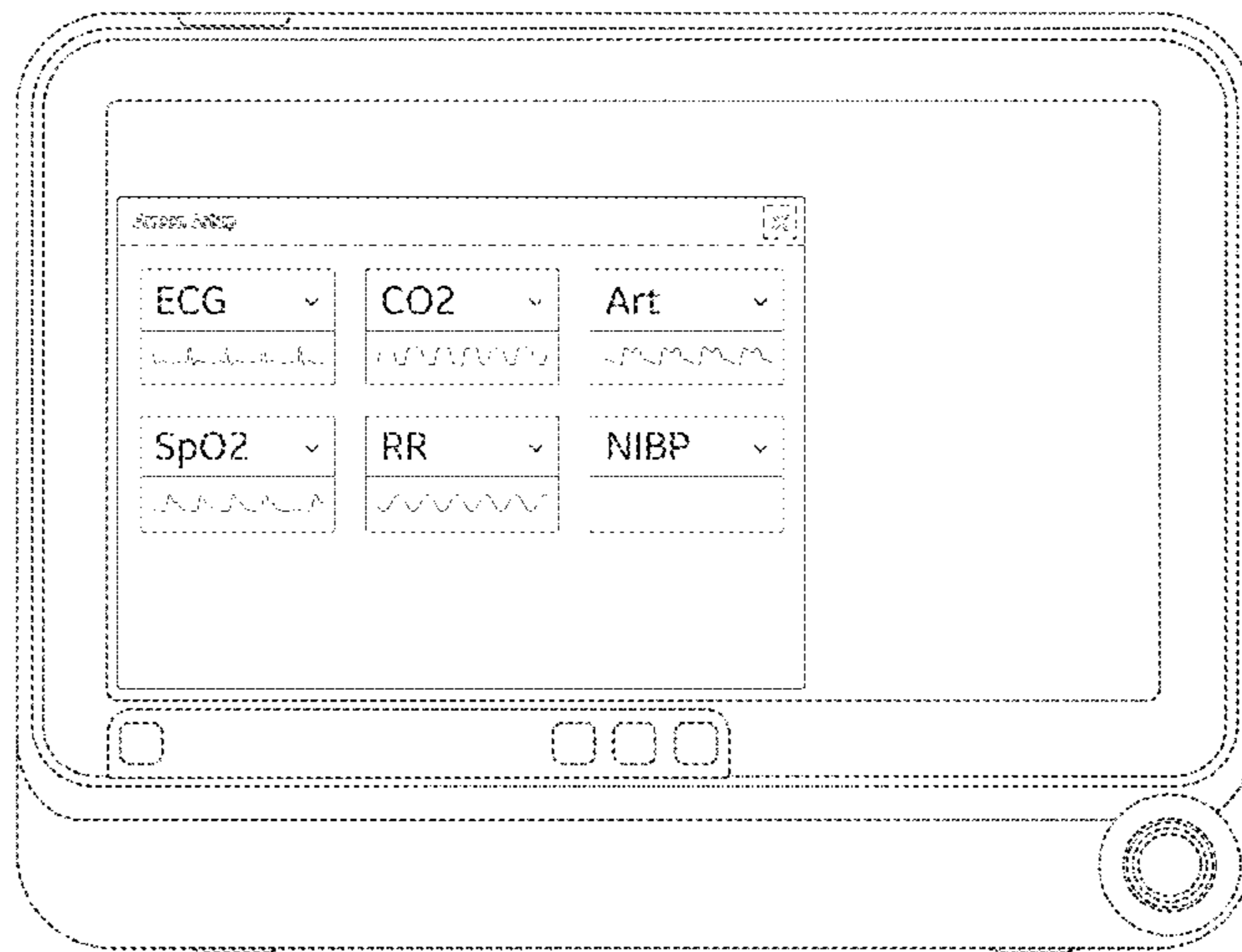

(58) **Field of Classification Search**

CPC 16/0051; A61M 16/0666; G16H 40/67;
 G16H 10/60; G16H 20/10; G16H 40/63;
 A61B 5/339; A61B 5/0205; A61B
 5/7445; A61B 34/35; G08B 5/36; H04M
 3/2281; G06T 11/206

See application file for complete search history.

(56) **References Cited**

U.S. PATENT DOCUMENTS

D462,077 S * 8/2002 Greninger D14/487
 D593,575 S * 6/2009 Ball D14/486
 D632,699 S * 2/2011 Judy D14/486
 D652,051 S 1/2012 Judy et al.
 D678,302 S * 3/2013 Trumble D14/486
 8,418,692 B2 * 4/2013 Sanchez A61M 16/0051
 128/204.21
 D686,634 S * 7/2013 Malasani D14/486
 D733,727 S 7/2015 Cojuangco et al.
 9,160,853 B1 * 10/2015 Daddi H04M 3/2281
 D773,478 S * 12/2016 Wesley D14/485
 D792,431 S * 7/2017 Grassle G16H 40/67
 D14/486
 D797,132 S * 9/2017 Rhodes D14/486
 10,137,245 B2 * 11/2018 Melker A61B 5/0205

D899,437 S * 10/2020 Carbonell D14/485
 11,037,662 B2 * 6/2021 Qing G06F 3/04847
 2003/0135087 A1 * 7/2003 Hickle G16H 20/10
 600/26
 2011/0071420 A1 * 3/2011 St. Pierre A61B 5/7445
 600/549
 2012/0078647 A1 * 3/2012 Grassle G16H 40/67
 705/2
 2013/0276785 A1 * 10/2013 Melker A61M 16/0666
 128/204.23
 2015/0301717 A1 * 10/2015 Wekell G06T 11/206
 715/835
 2018/0277243 A1 * 9/2018 Qing A61B 5/339
 2019/0224434 A1 * 7/2019 Silver A61M 16/0003
 2019/0362822 A1 * 11/2019 Haveri G08B 5/36
 2020/0081585 A1 * 3/2020 Petre A61B 34/35
 2020/0357493 A1 * 11/2020 Kelly G16H 10/60
 2021/0236755 A1 * 8/2021 King G16H 40/63

OTHER PUBLICATIONS

“Checking the Monitors” Nov. 13, 2012, posted at castyournet.
 wordpress.com, [site visied Apr. 22, 2021]. [https://castyournet.
 wordpress.com/2012/11](https://castyournet.wordpress.com/2012/11) (Year: 2012).*

* cited by examiner

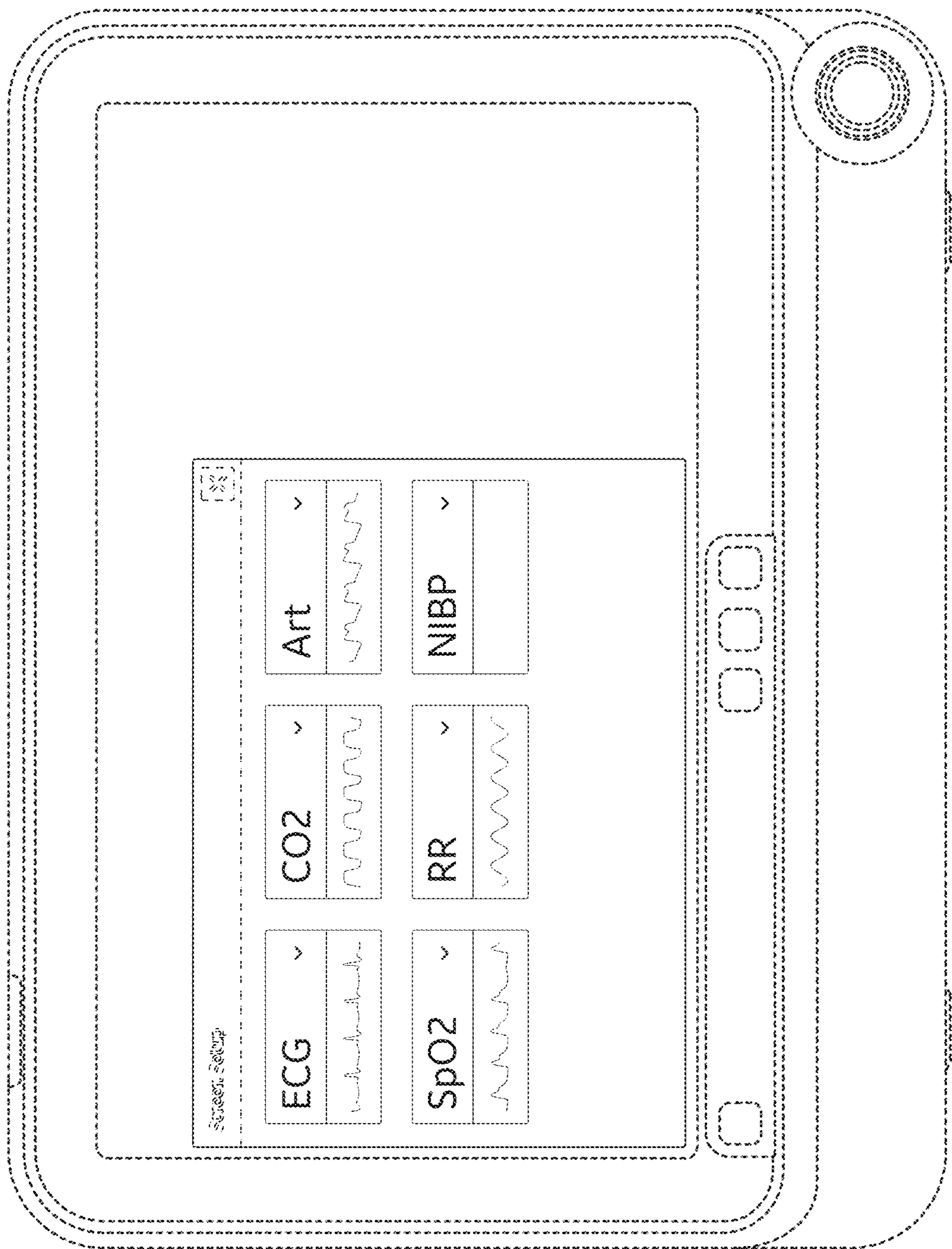

FIG. 1

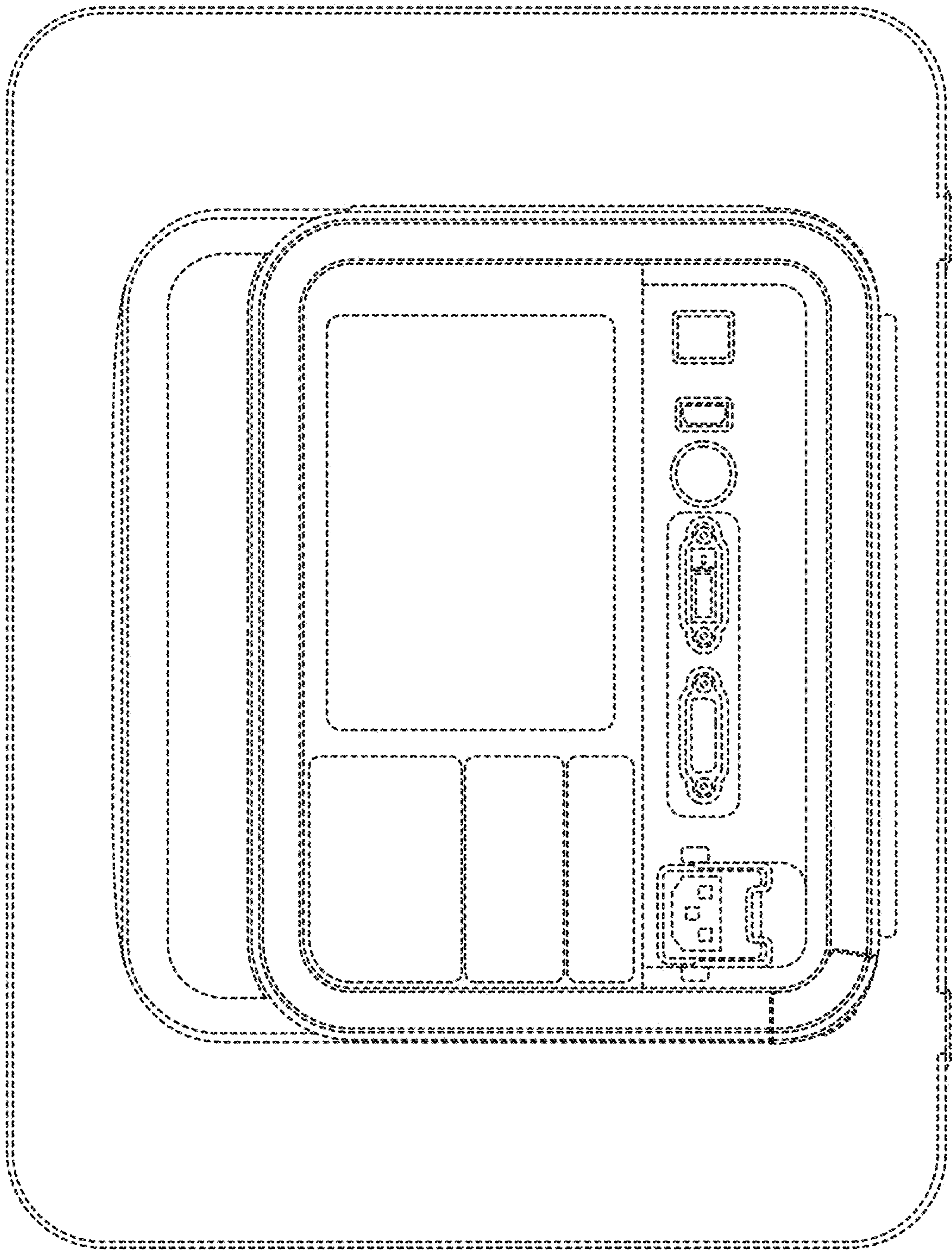

FIG. 3

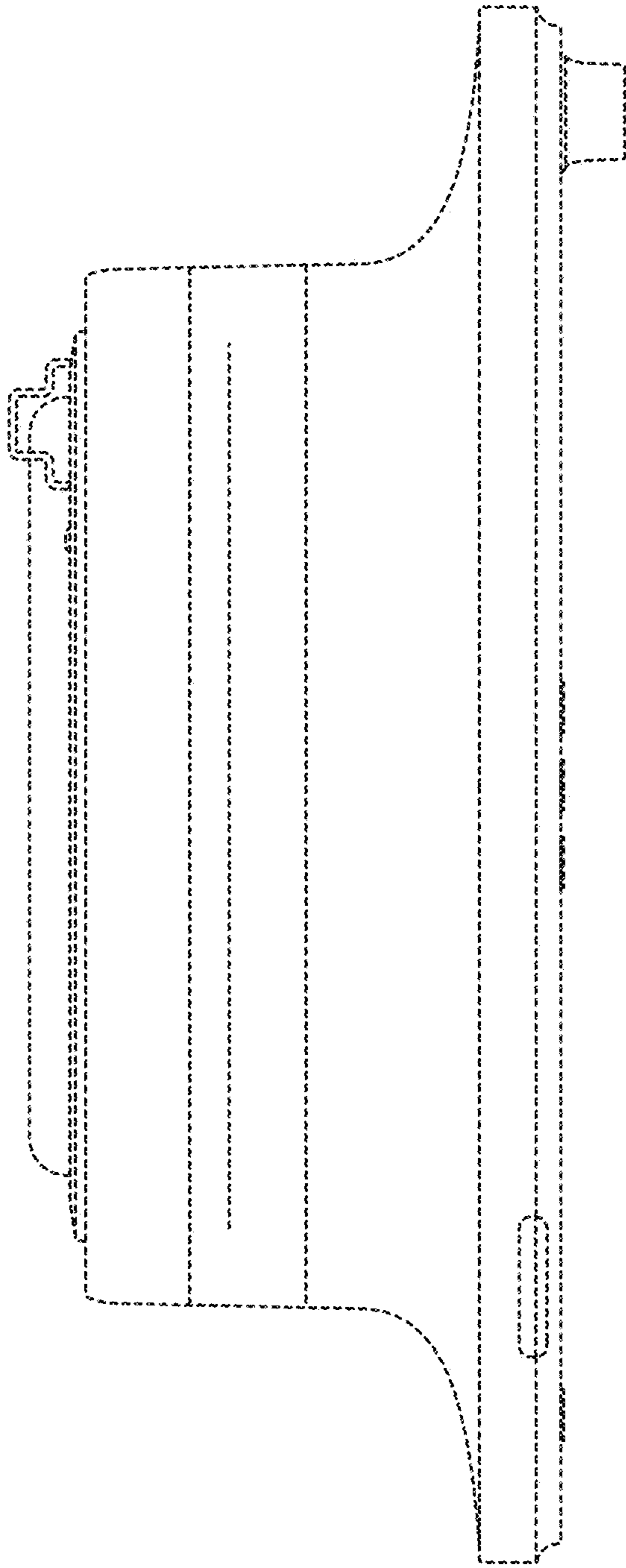

FIG. 4

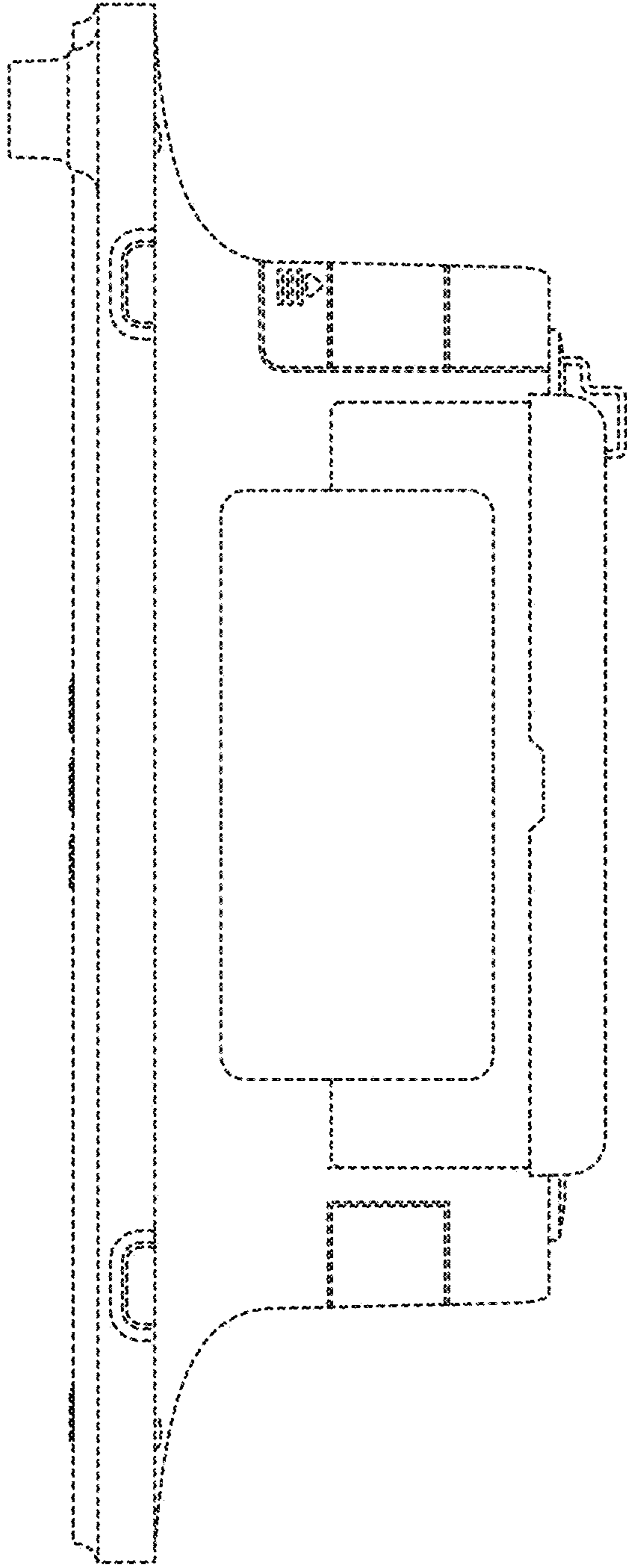

FIG. 5

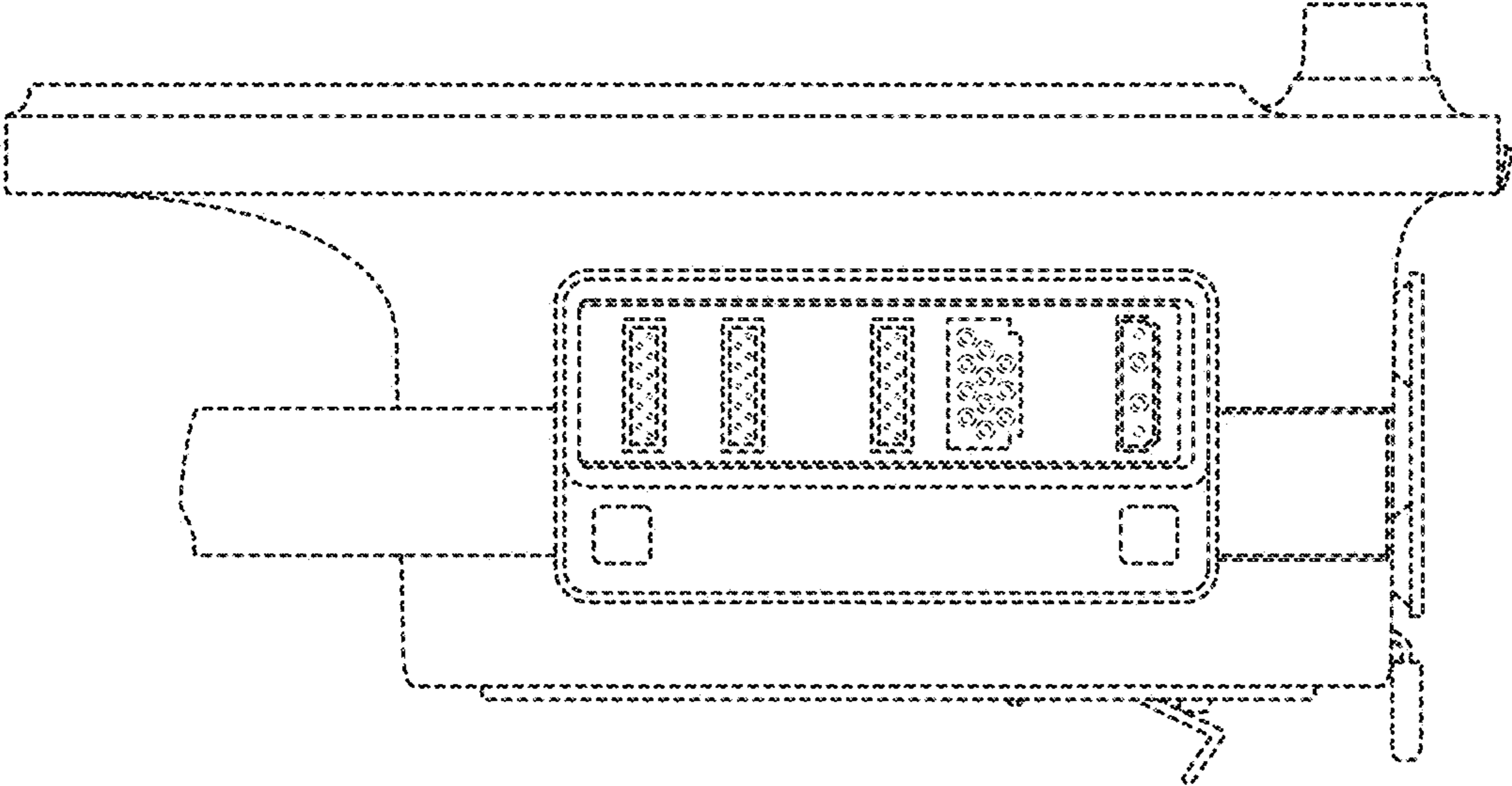

FIG. 6

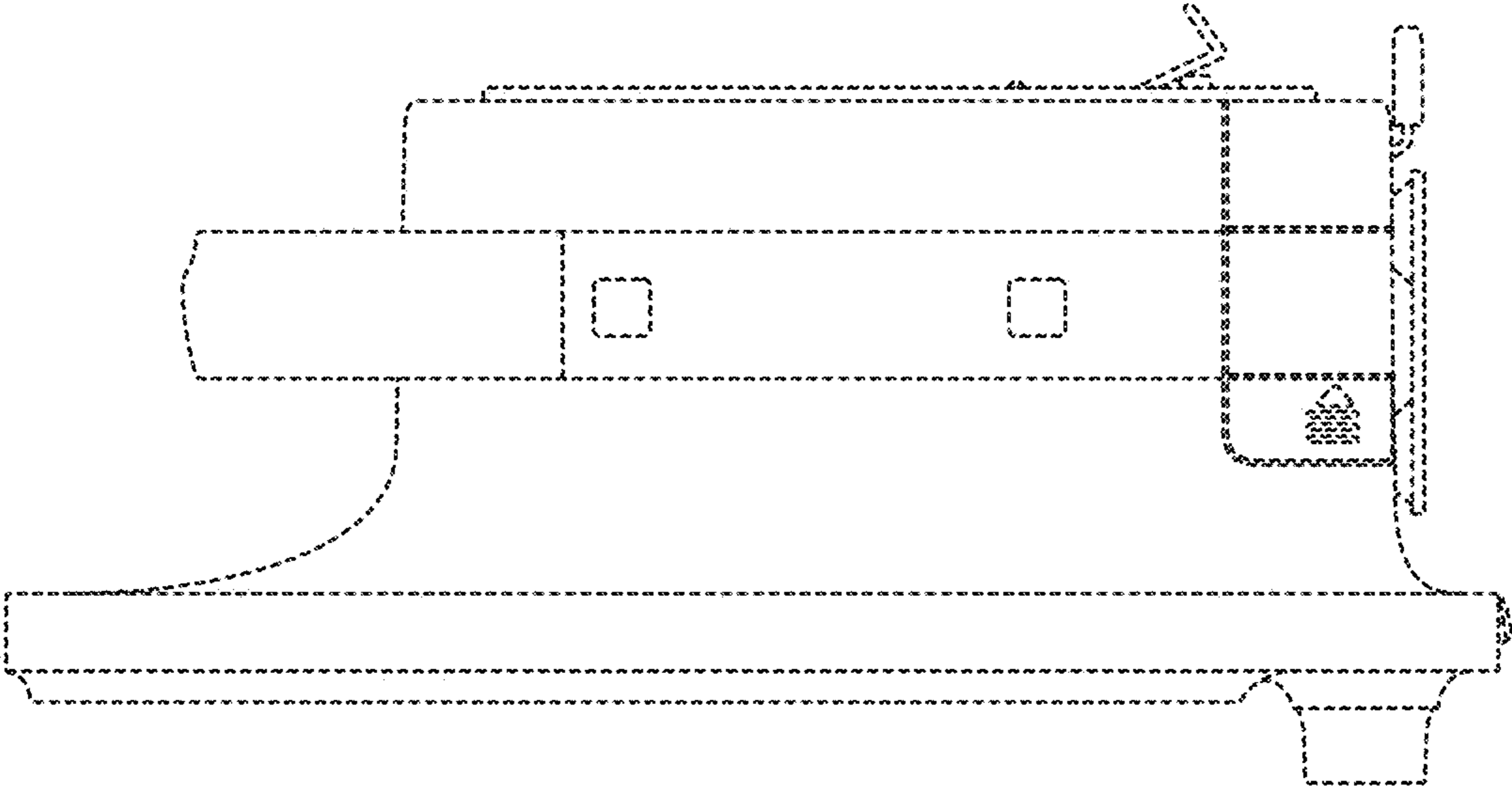

FIG. 7

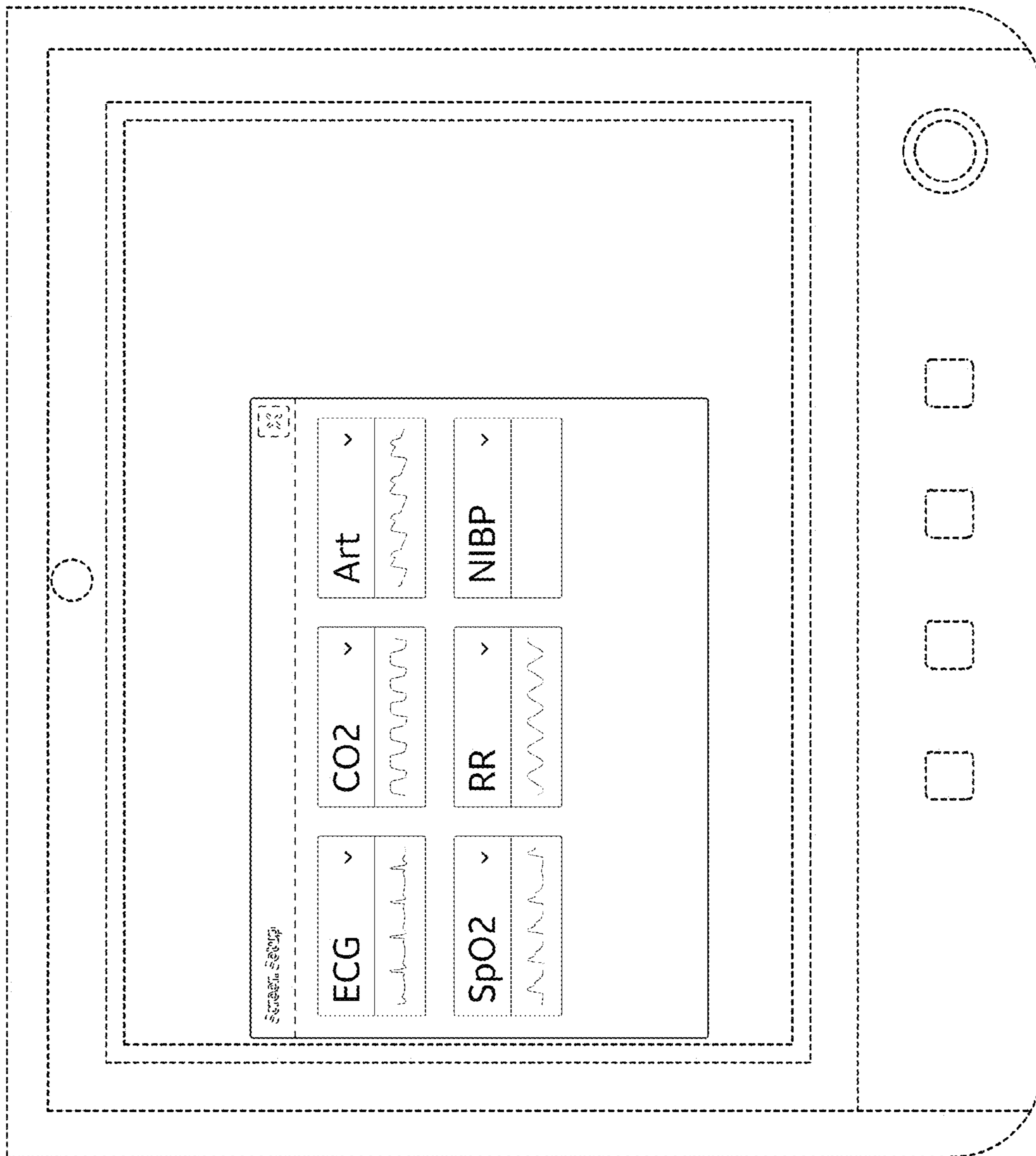

FIG. 8

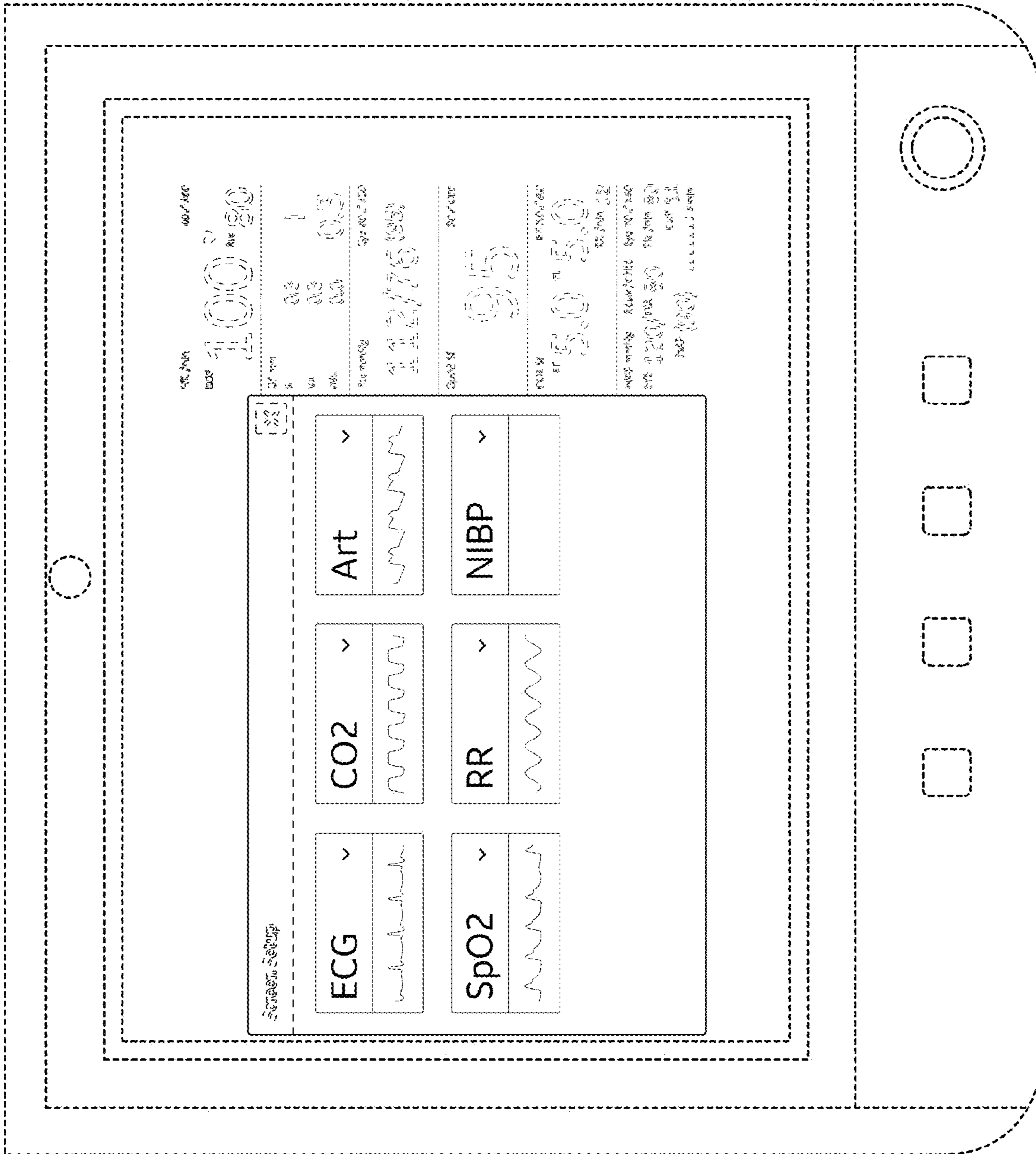

FIG. 9

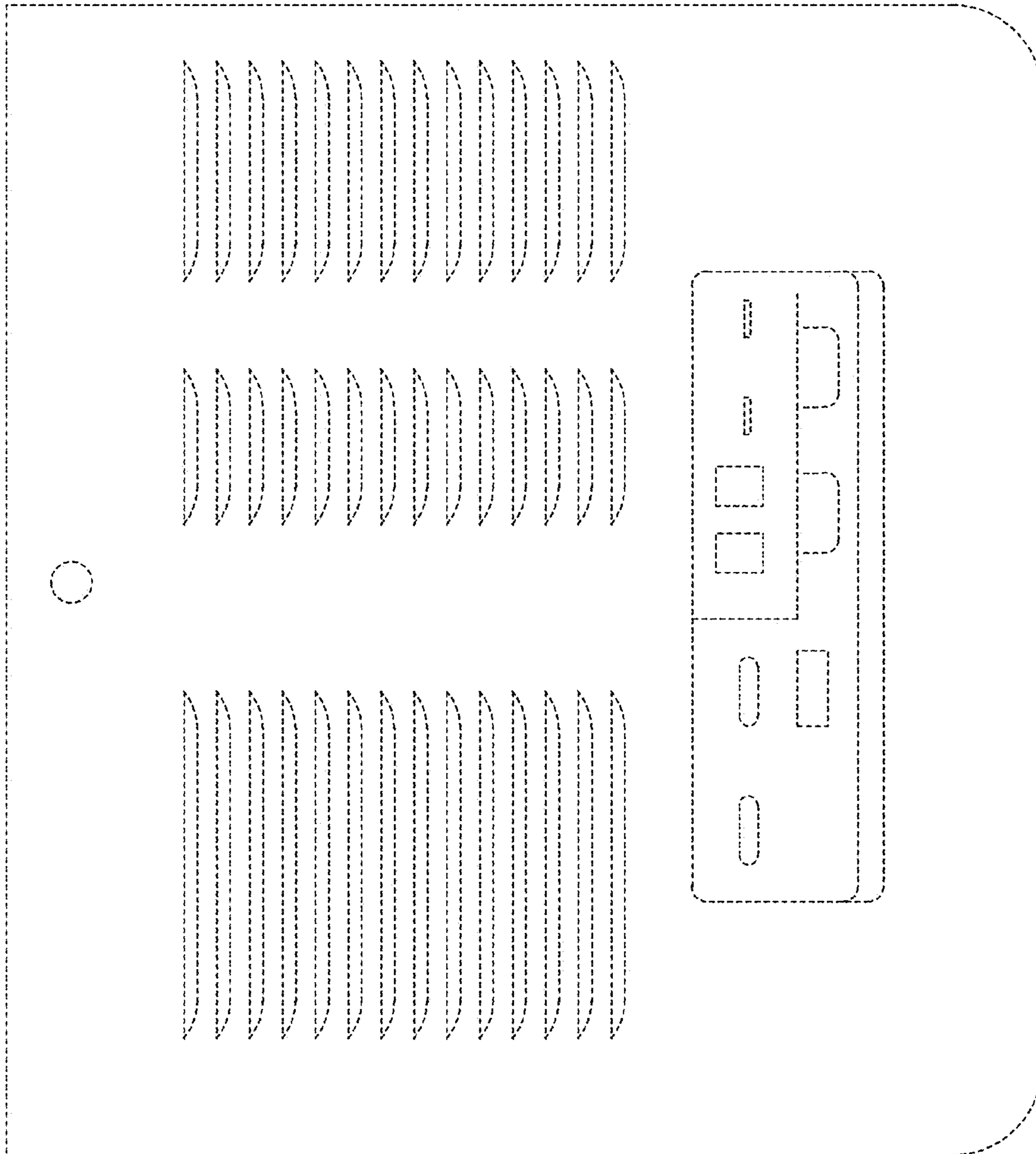

FIG. 10

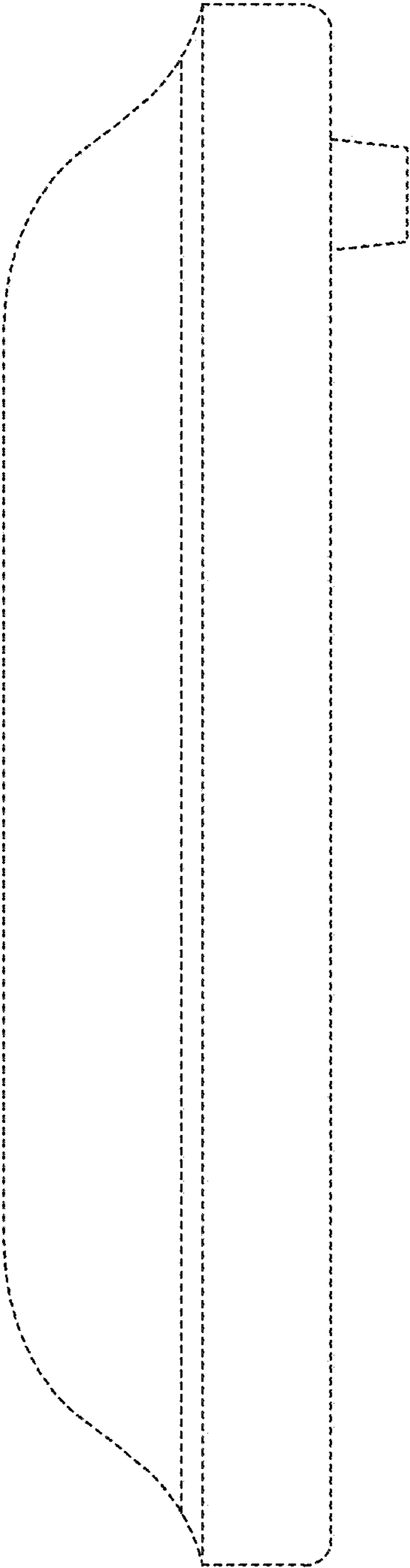

FIG. 11

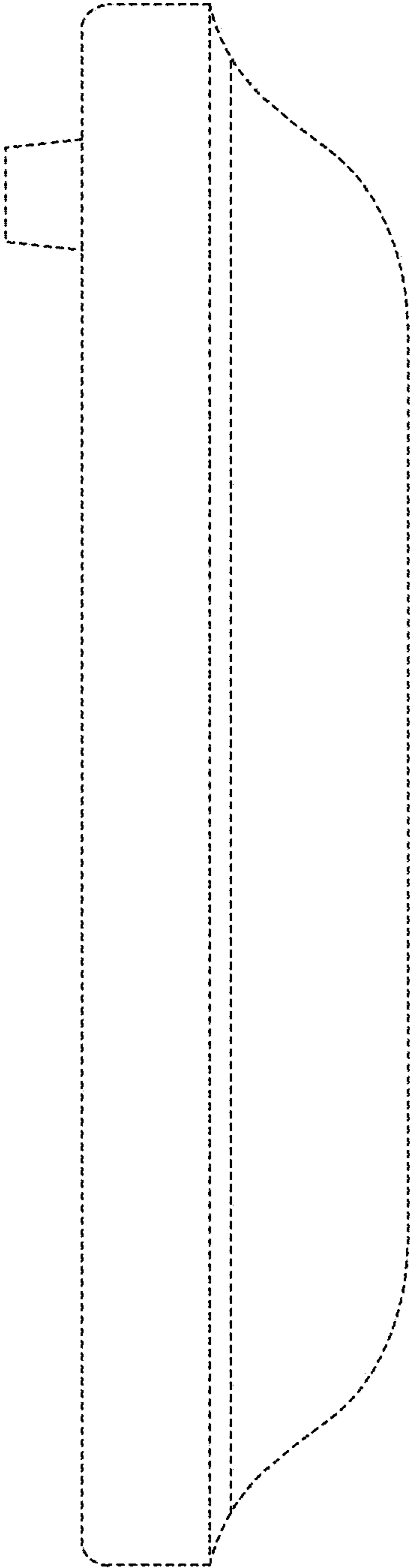

FIG. 12

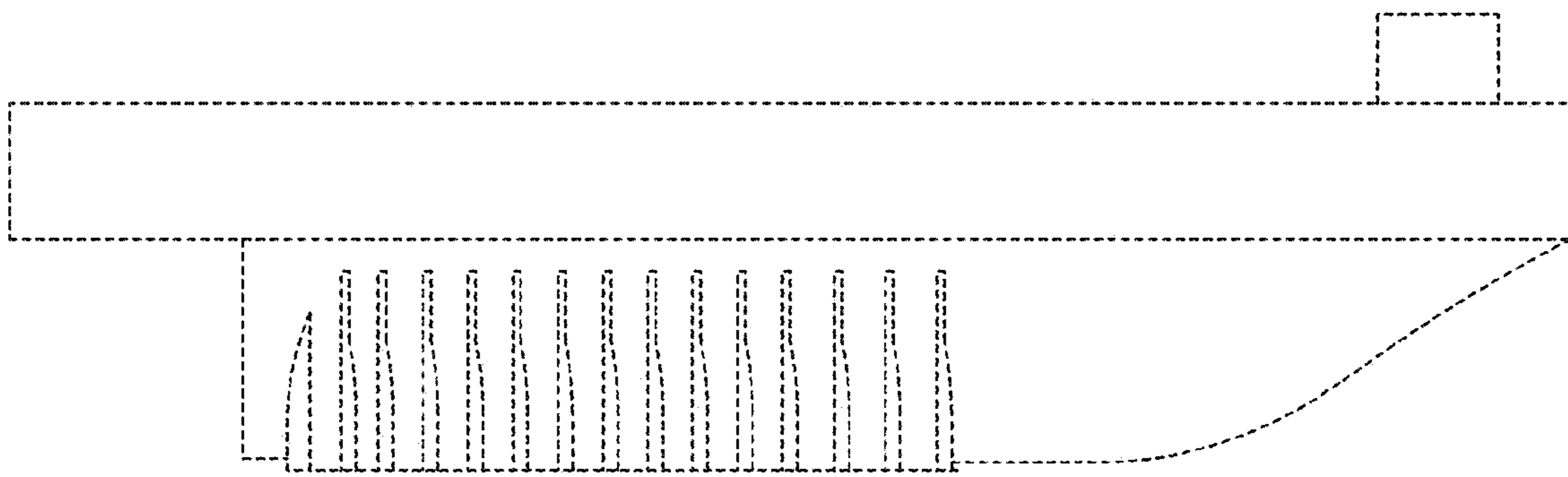
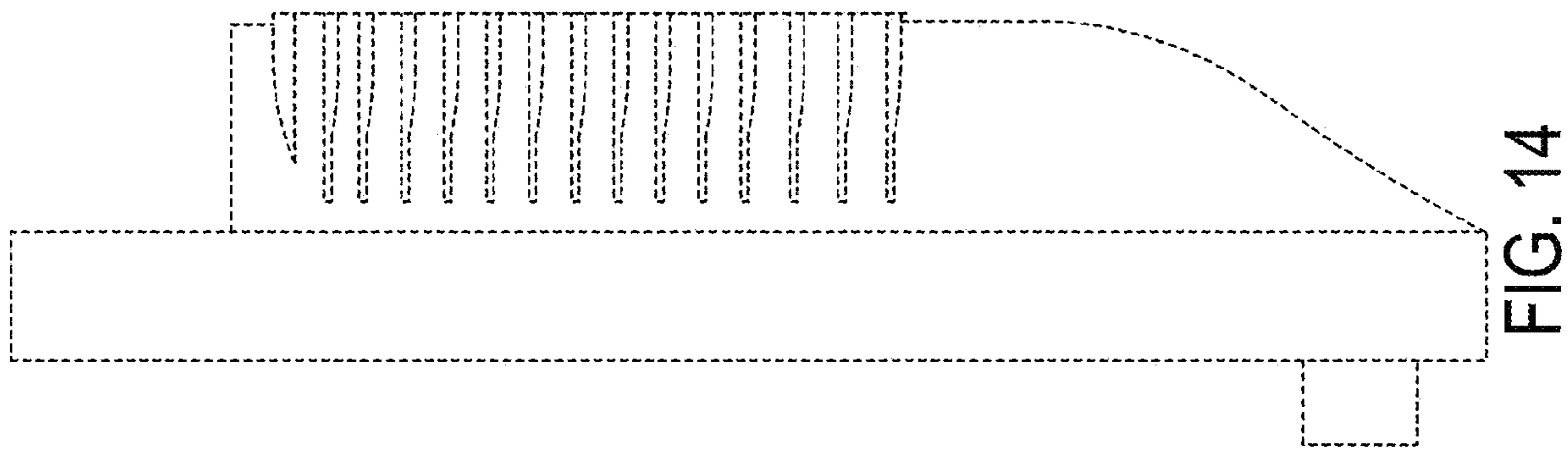

FIG. 13



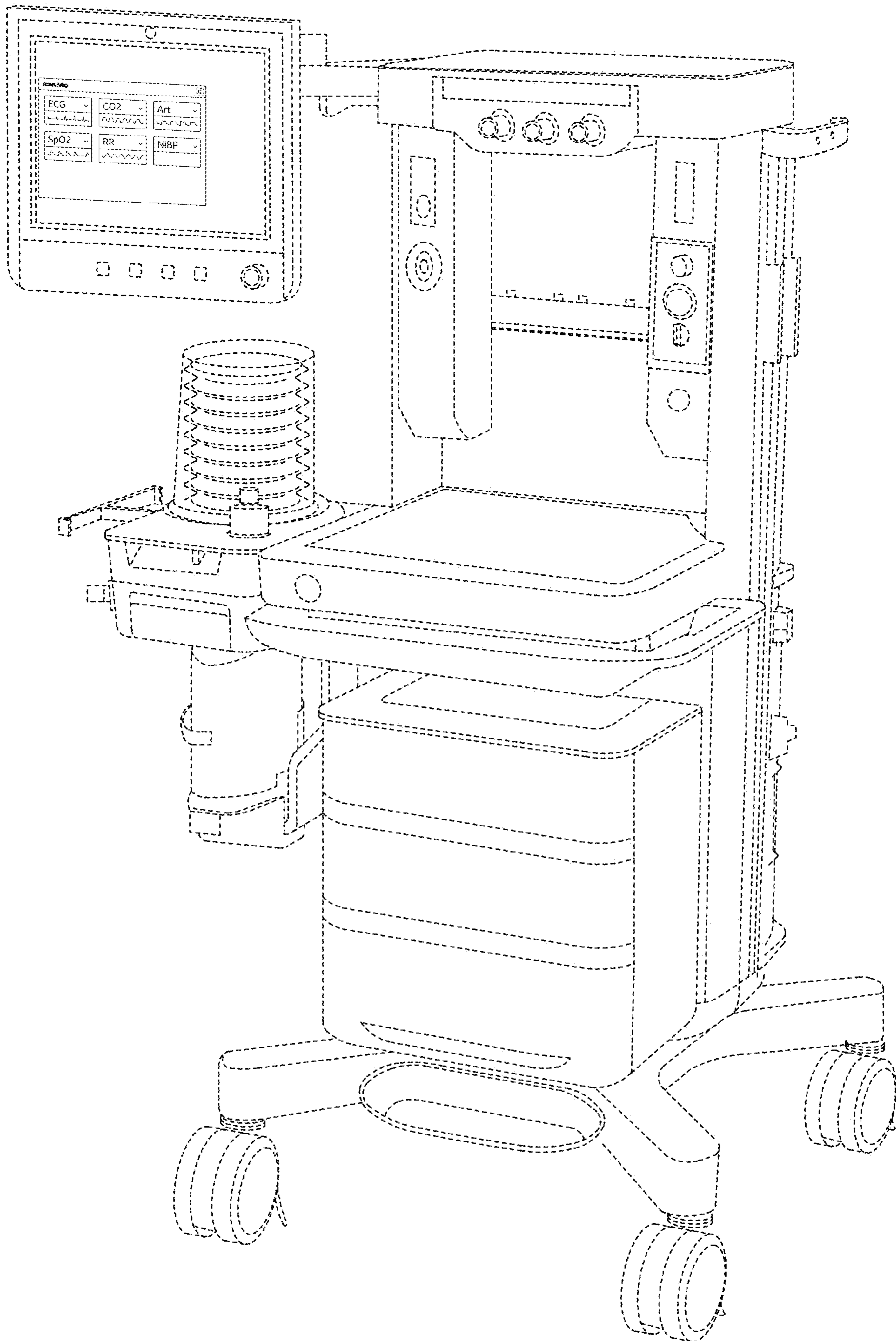

FIG. 15