



US00D938946S

(12) **United States Design Patent**
Harley et al.

(10) **Patent No.: US D938,946 S**
(45) **Date of Patent: ** Dec. 21, 2021**

(54) **ENCLOSURE FOR A CUSTOMER PREMISE EQUIPMENT DEVICE**

DESCRIPTION

(71) Applicant: **ARRIS Enterprises LLC**, Suwanee, GA (US)

(72) Inventors: **Paul Joseph Harley**, West Yorkshire (GB); **Roy B. Ward**, Redmond, WA (US); **J. Stephen Wells**, Flowery Branch, GA (US); **Brent K. Mills**, Alpharetta, GA (US)

(73) Assignee: **ARRIS Enterprises LLC**, Suwanee, GA (US)

(**) Term: **15 Years**

(21) Appl. No.: **29/668,011**

(22) Filed: **Oct. 26, 2018**

(51) **LOC (13) Cl.** **14-03**

(52) **U.S. Cl.**
USPC **D14/242**

(58) **Field of Classification Search**
USPC D14/240, 242, 357, 358, 155, 125, 126, D14/137, 139, 243, 348, 349, 351, 354, D14/355, 435.1, 204, 214, 215, 216
(Continued)

(56) **References Cited**

U.S. PATENT DOCUMENTS

D201,054 S * 5/1965 Roach D9/432
D309,728 S * 8/1990 Nuttall D14/356
(Continued)

Primary Examiner — Bridget L Eland

(74) *Attorney, Agent, or Firm* — Buchanan, Ingersoll & Rooney PC

(57) **CLAIM**

The ornamental design for an enclosure for a customer premise equipment device, as shown and described.

FIG. 1 is a front perspective view of a first embodiment of an enclosure for a customer premise equipment device, showing our new design;
FIG. 2 is a front elevation view of the enclosure for a customer premise equipment device of FIG. 1;
FIG. 3 is a top view of the enclosure for a customer premise equipment device of FIG. 1;
FIG. 4 is a bottom view of the enclosure for a customer premise equipment device of FIG. 1;
FIG. 5 is a rear elevation view of the enclosure for a customer premise equipment device of FIG. 1;
FIG. 6 is a right side elevation view of the enclosure for a customer premise equipment device of FIG. 1;
FIG. 7 is a left side elevation view of the enclosure for a customer premise equipment device of FIG. 1;
FIG. 8 is a bottom, front perspective view of the enclosure for a customer premise equipment device of FIG. 1;
FIG. 9 is a rear perspective view of the enclosure for a customer premise equipment device of FIG. 1;
FIG. 10 is a bottom, rear perspective view of the enclosure for a customer premise equipment device of FIG. 1;
FIG. 11 is a front perspective view of a second embodiment of an enclosure for a customer premise equipment device, showing our new design;
FIG. 12 is a front elevation view of the enclosure for a customer premise equipment device of FIG. 11;
FIG. 13 is a top view of the enclosure for a customer premise equipment device of FIG. 11;
FIG. 14 is a bottom view of the enclosure for a customer premise equipment device of FIG. 11;
FIG. 15 is a rear elevation view of the enclosure for a customer premise equipment device of FIG. 11;
FIG. 16 is a right side elevation view of the enclosure for a customer premise equipment device of FIG. 11;
FIG. 17 is a left side elevation view of the enclosure for a customer premise equipment device of FIG. 11;
FIG. 18 is a bottom, front perspective view of the enclosure for a customer premise equipment device of FIG. 11;
FIG. 19 is a rear perspective view of the enclosure for a customer premise equipment device of FIG. 11;

(Continued)

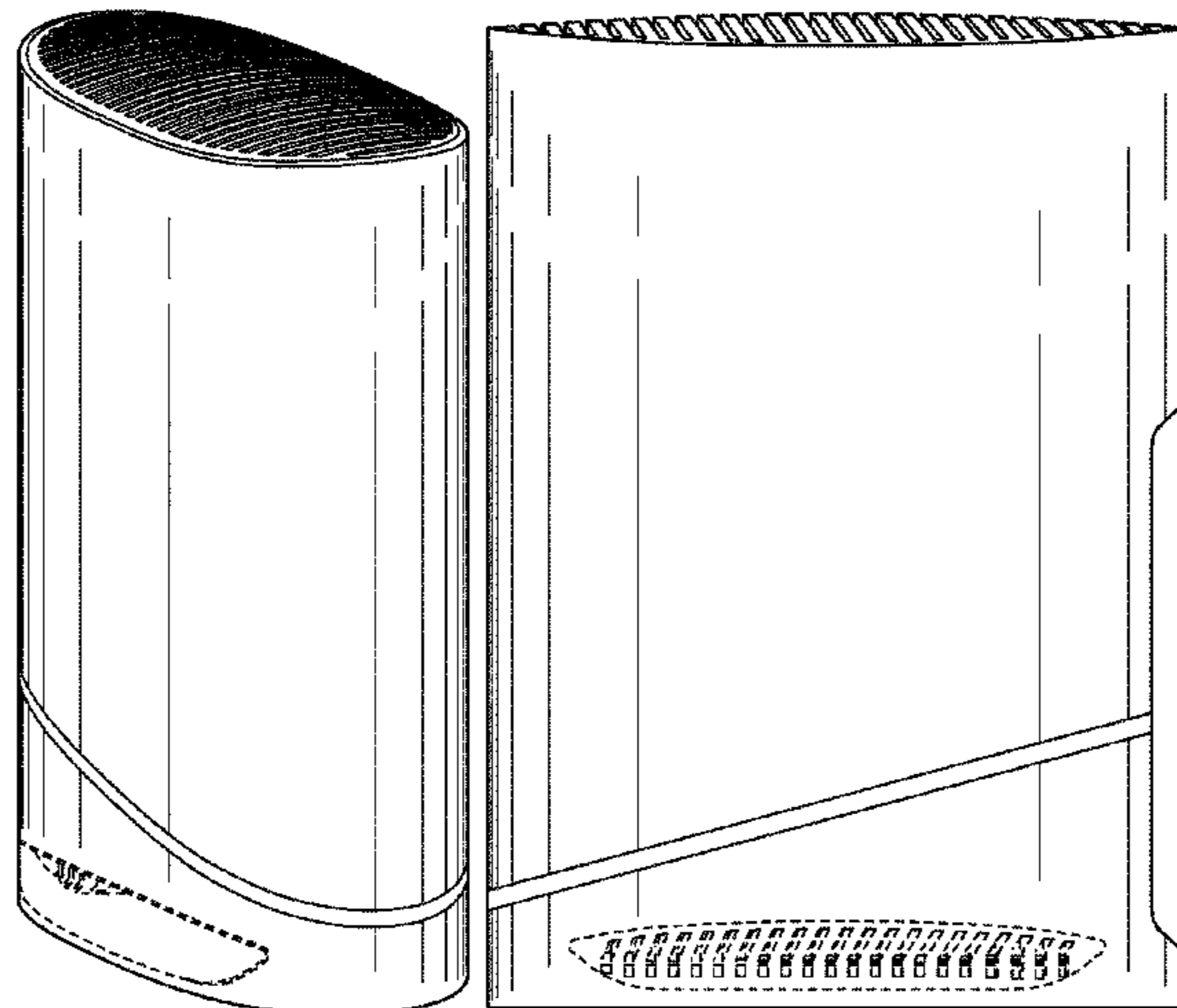

FIG. 20 is a bottom, rear perspective view of the enclosure for a customer premise equipment device of FIG. 11;
 FIG. 21 is a front perspective view of a third embodiment of an enclosure for a customer premise equipment device, showing our new design;
 FIG. 22 is a front elevation view of the enclosure for a customer premise equipment device of FIG. 21;
 FIG. 23 is a top view of the enclosure for a customer premise equipment device of FIG. 21;
 FIG. 24 is a rear elevation view of the enclosure for a customer premise equipment device of FIG. 21;
 FIG. 25 is a right side elevation view of the enclosure for a customer premise equipment device of FIG. 21;
 FIG. 26 is a left side elevation view of the enclosure for a customer premise equipment device of FIG. 21;
 FIG. 27 is a bottom, front perspective view of the enclosure for a customer premise equipment device of FIG. 21;
 FIG. 28 is a rear perspective view of the enclosure for a customer premise equipment device of FIG. 21; and,
 FIG. 29 is a bottom, rear perspective view of the enclosure for a customer premise equipment device of FIG. 21.
 The broken lines shown in the views are included for the purpose of illustrating portions of the enclosure for customer premise equipment device that form no part of the claimed design.

1 Claim, 29 Drawing Sheets

(58) **Field of Classification Search**

CPC . H04L 12/66; H04L 63/0853; H04L 63/0272;
 H04L 63/083; H04L 63/105; H05K 7/20;
 H05K 7/20154

See application file for complete search history.

(56) **References Cited**

U.S. PATENT DOCUMENTS

D503,718	S	*	4/2005	Heinz	D14/444
D607,878	S	*	1/2010	Murray	D14/216
D641,343	S	*	7/2011	Kim	D14/240
D648,726	S	*	11/2011	Behar	D14/435.1
D667,007	S	*	9/2012	Huang	D14/240
D745,589	S	*	12/2015	Lee	D16/218
D771,023	S	*	11/2016	Zhang	D14/240
D783,583	S	*	4/2017	Moon	D14/240
D790,539	S	*	6/2017	Lee	D14/358
D819,001	S	*	5/2018	Lee	D14/240
D823,844	S	*	7/2018	Ramones	D14/240
D833,411	S	*	11/2018	Castle	D14/155
D847,112	S	*	4/2019	Castle	D14/155
D856,318	S	*	8/2019	Ramones	D14/242
D862,436	S	*	10/2019	Ramones	D14/242
D868,034	S	*	11/2019	Summerson	D14/216
D873,881	S	*	1/2020	Ma	D16/202
D904,399	S	*	12/2020	Behar	D14/349

* cited by examiner

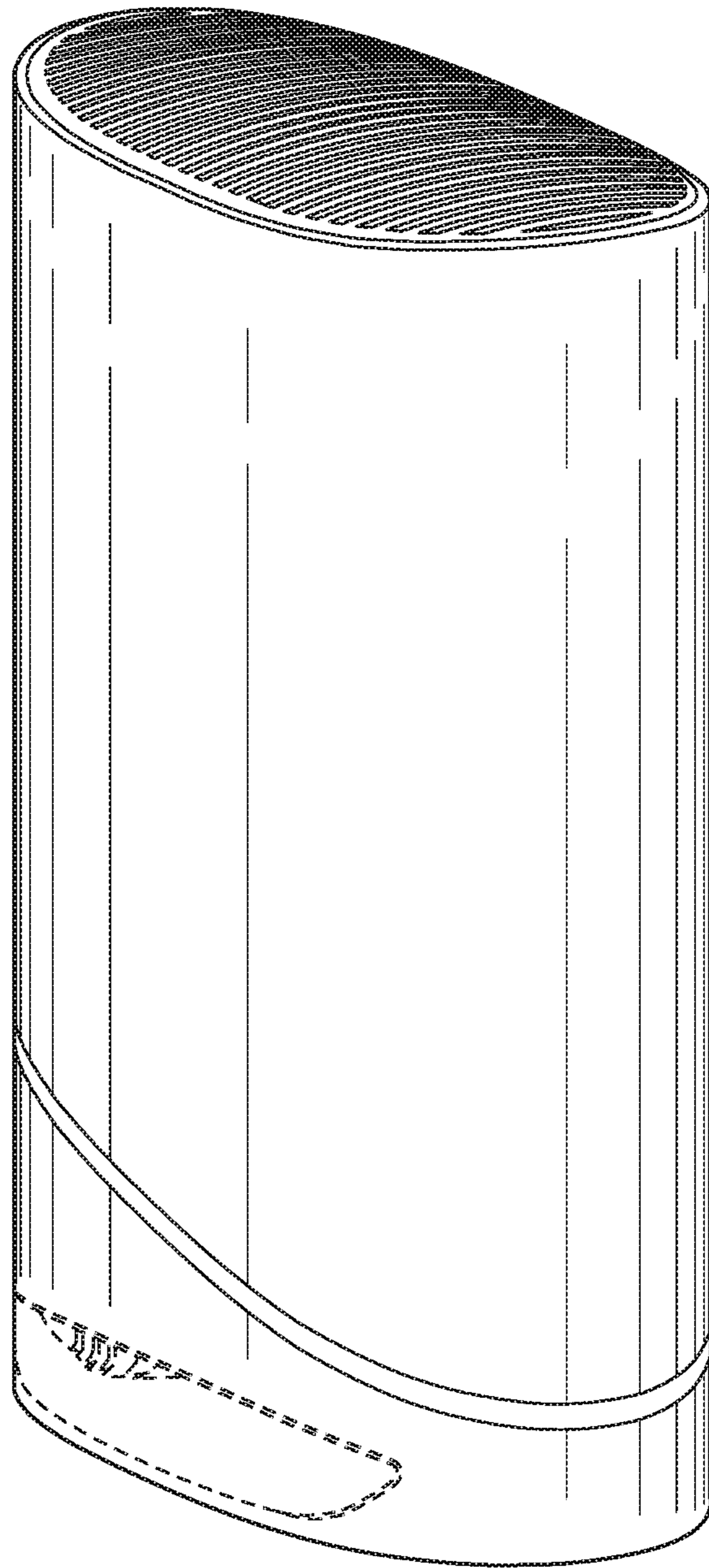

FIG. 1

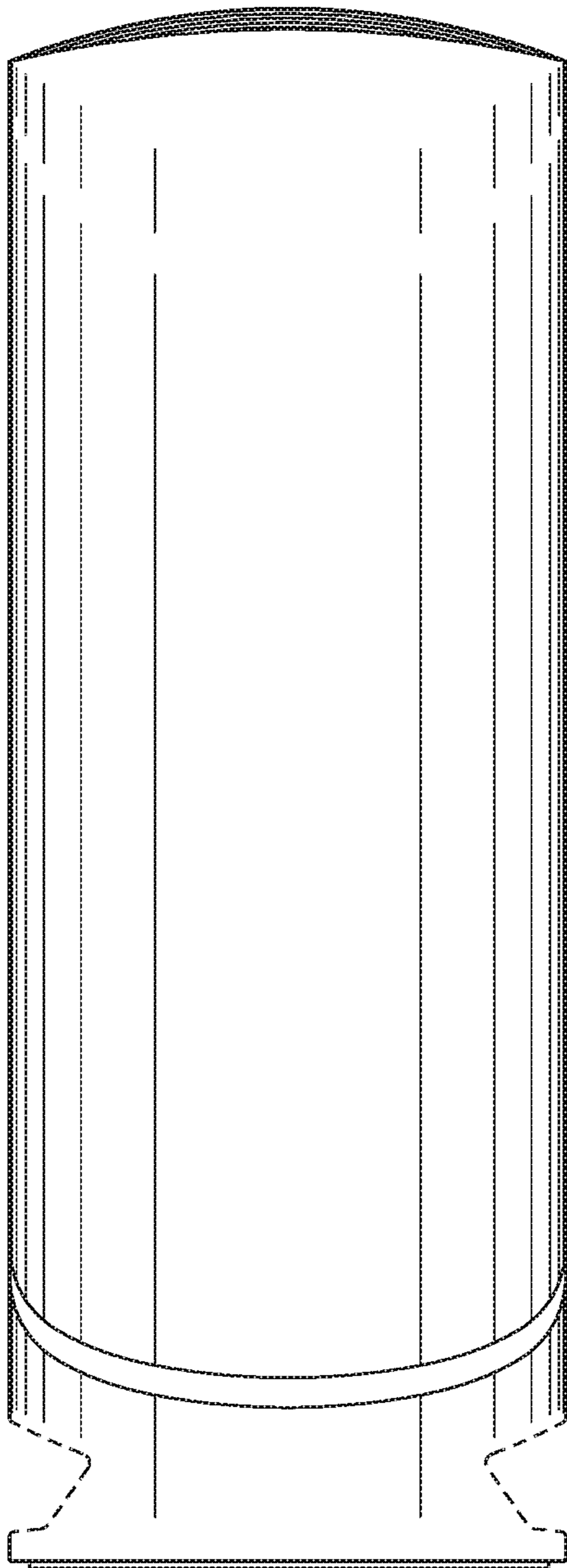

FIG. 2

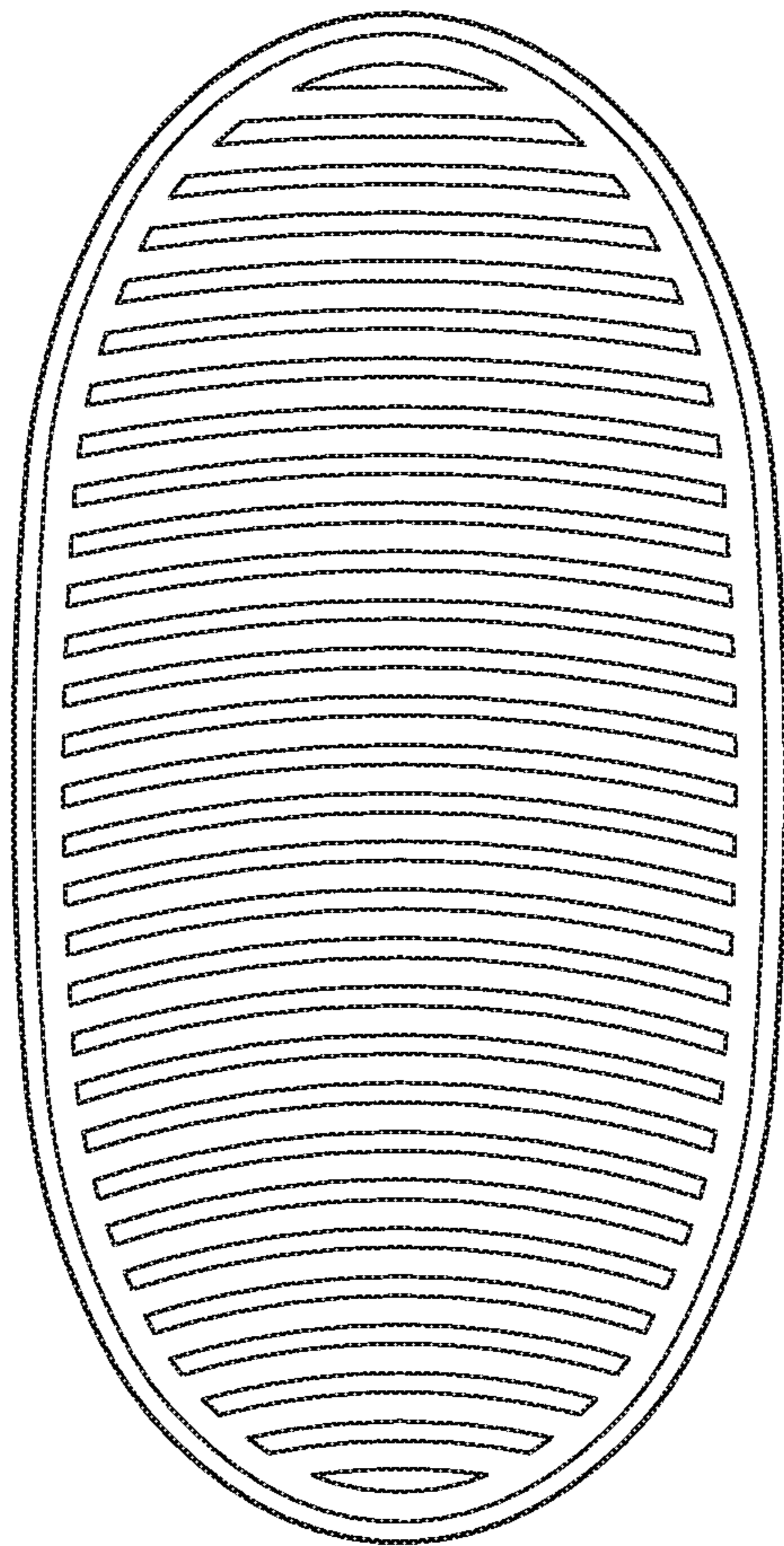

FIG. 3

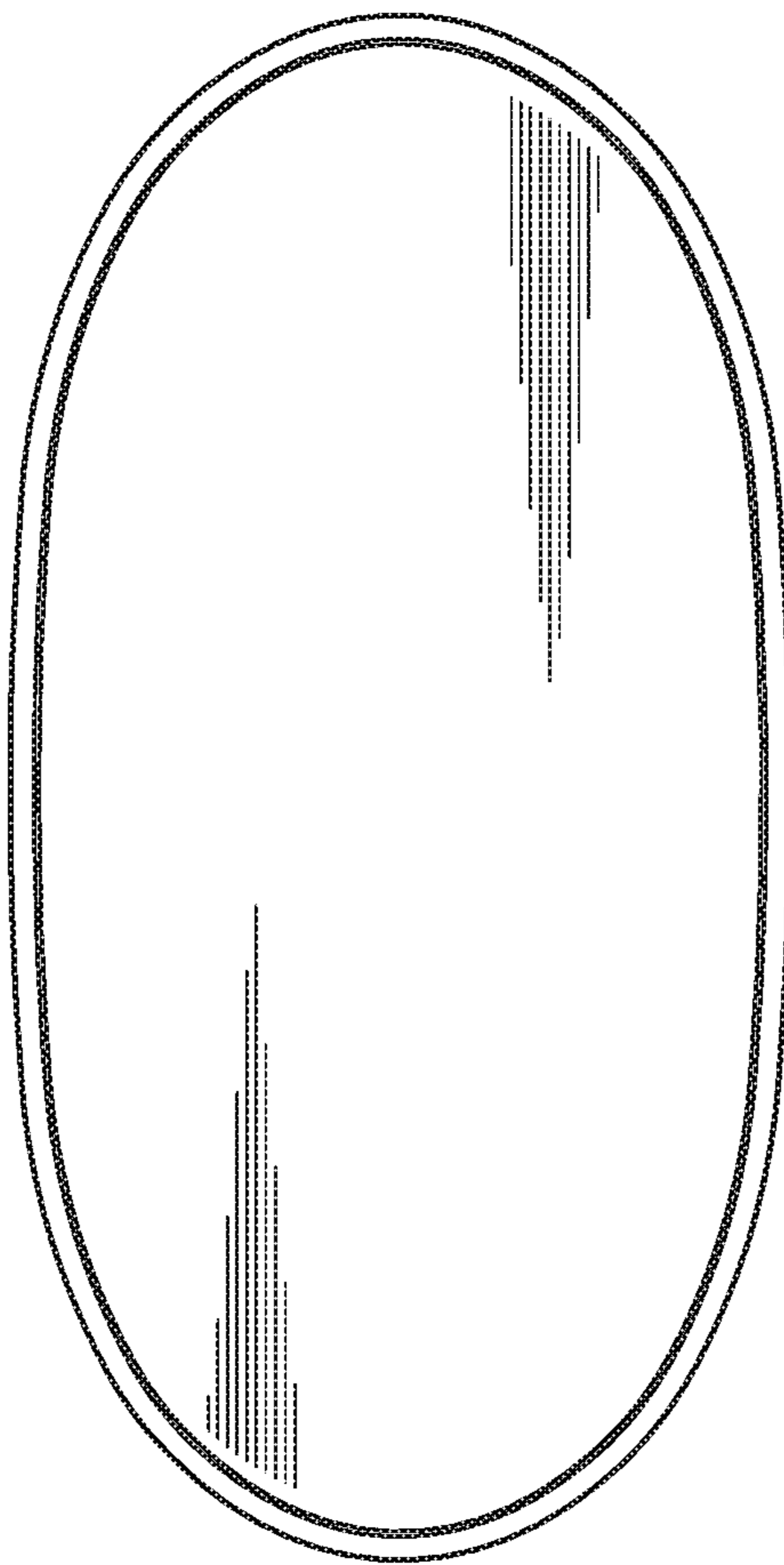

FIG. 4

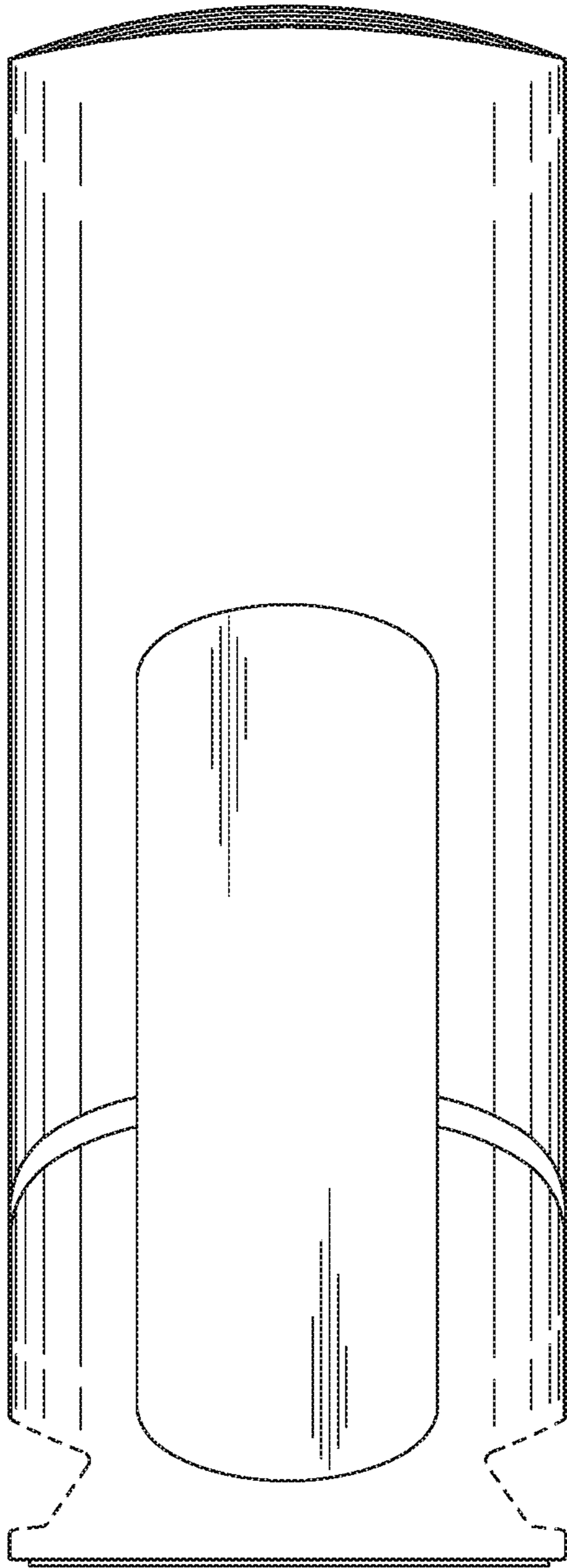

FIG. 5

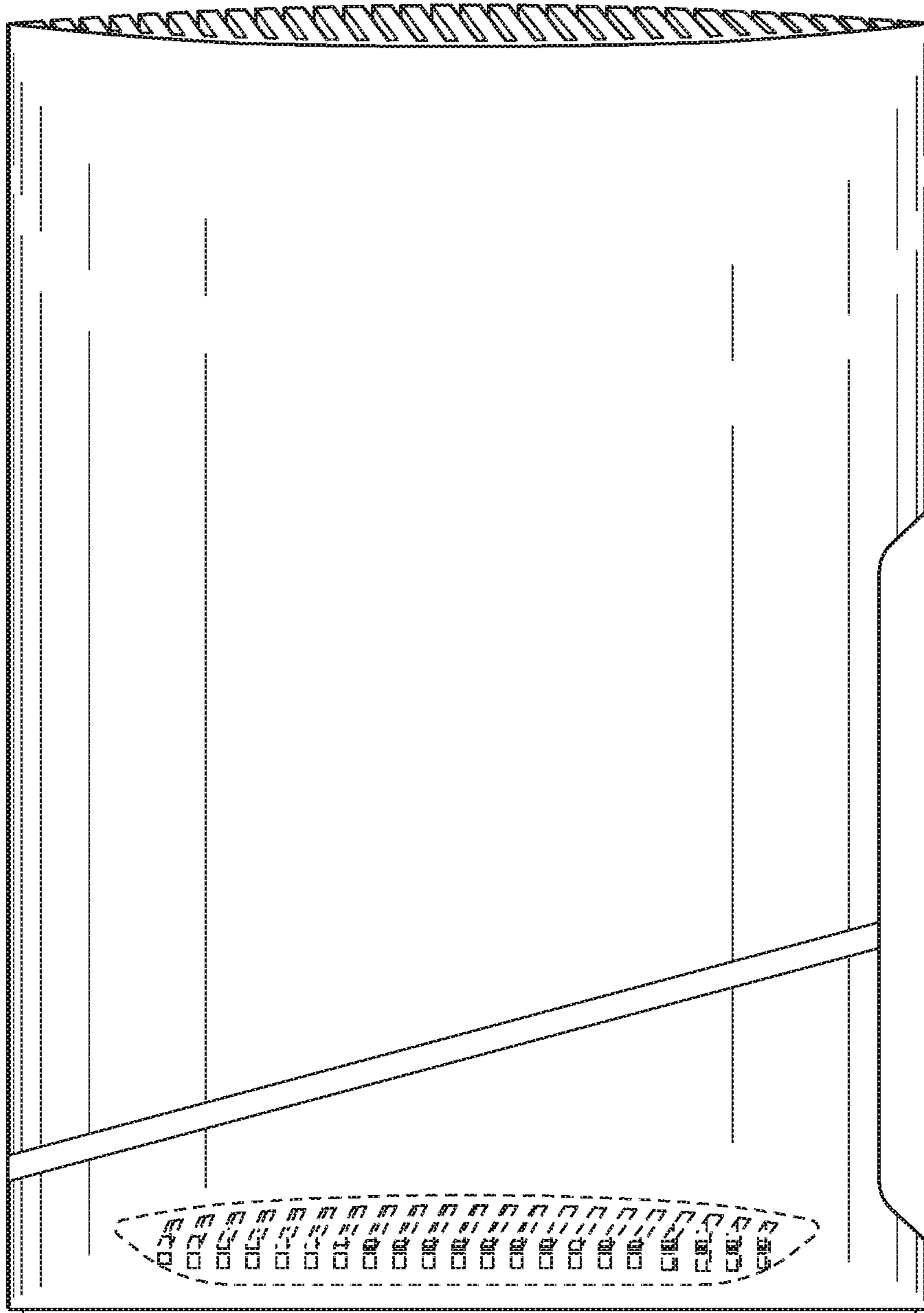

FIG. 6

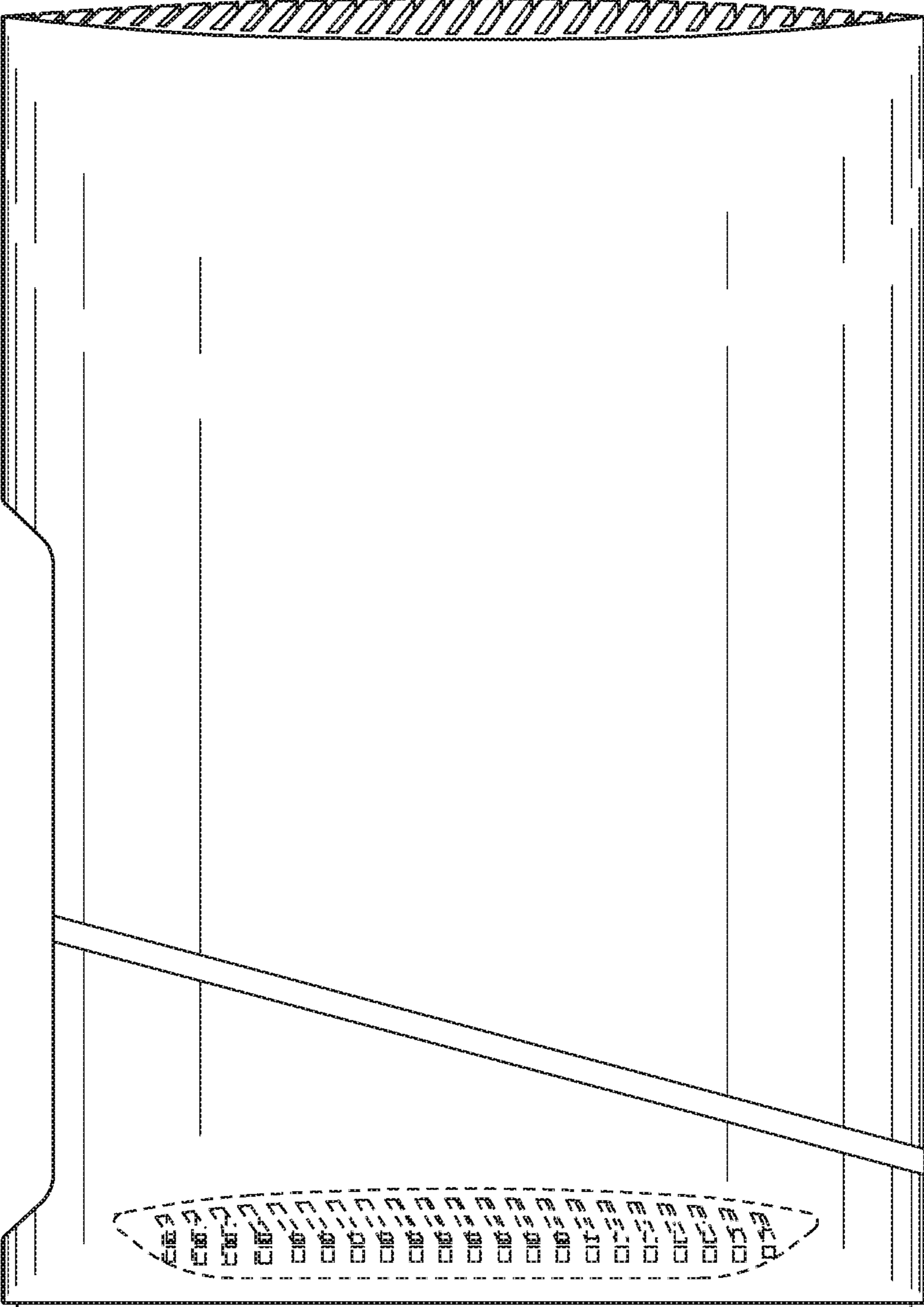

FIG. 7

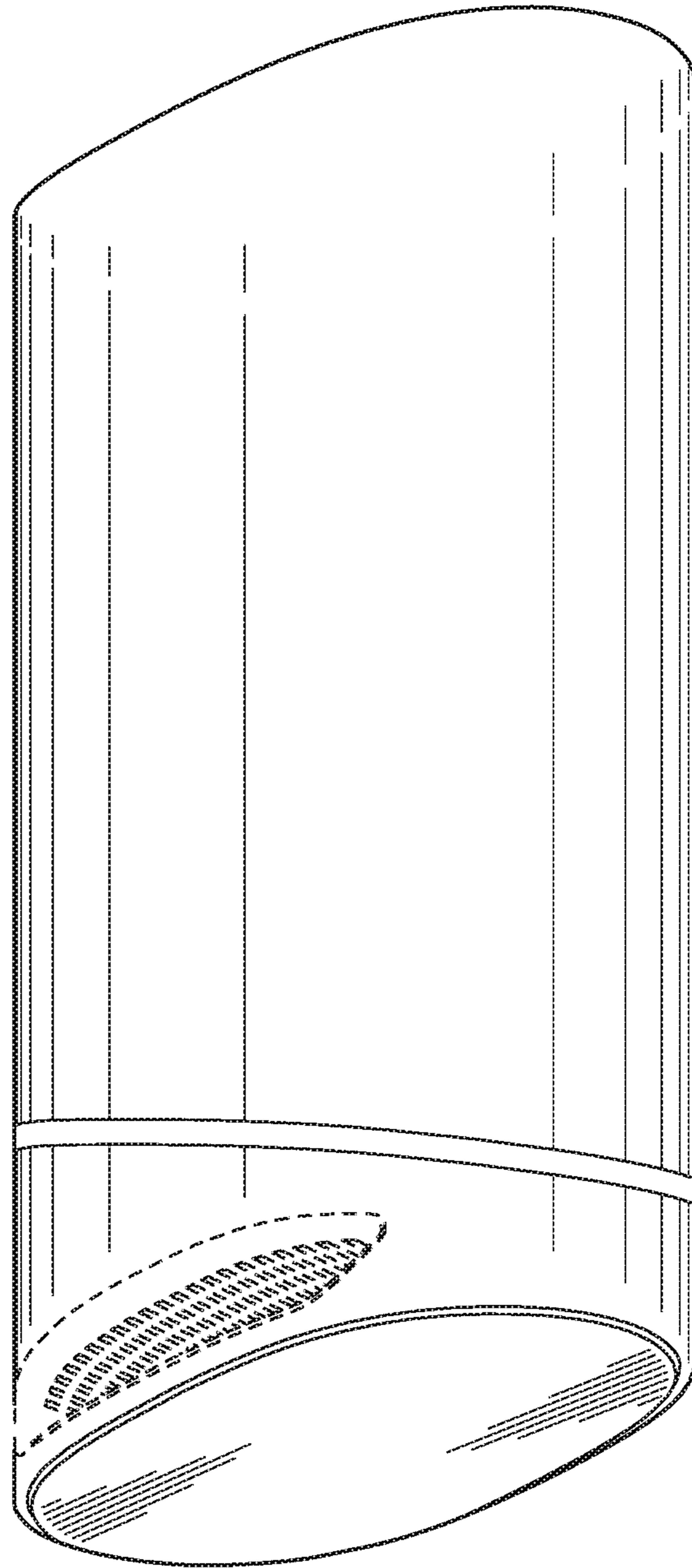

FIG. 8

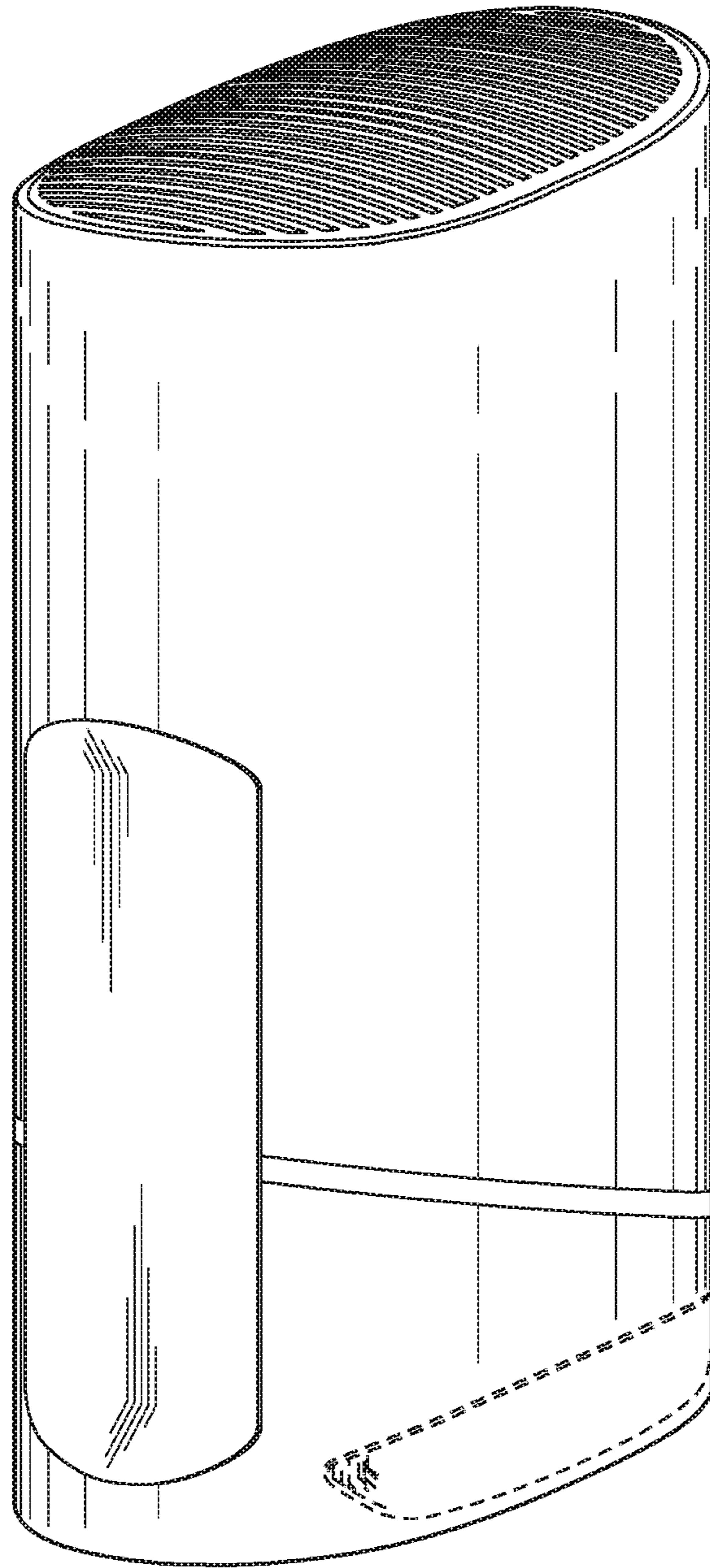

FIG. 9

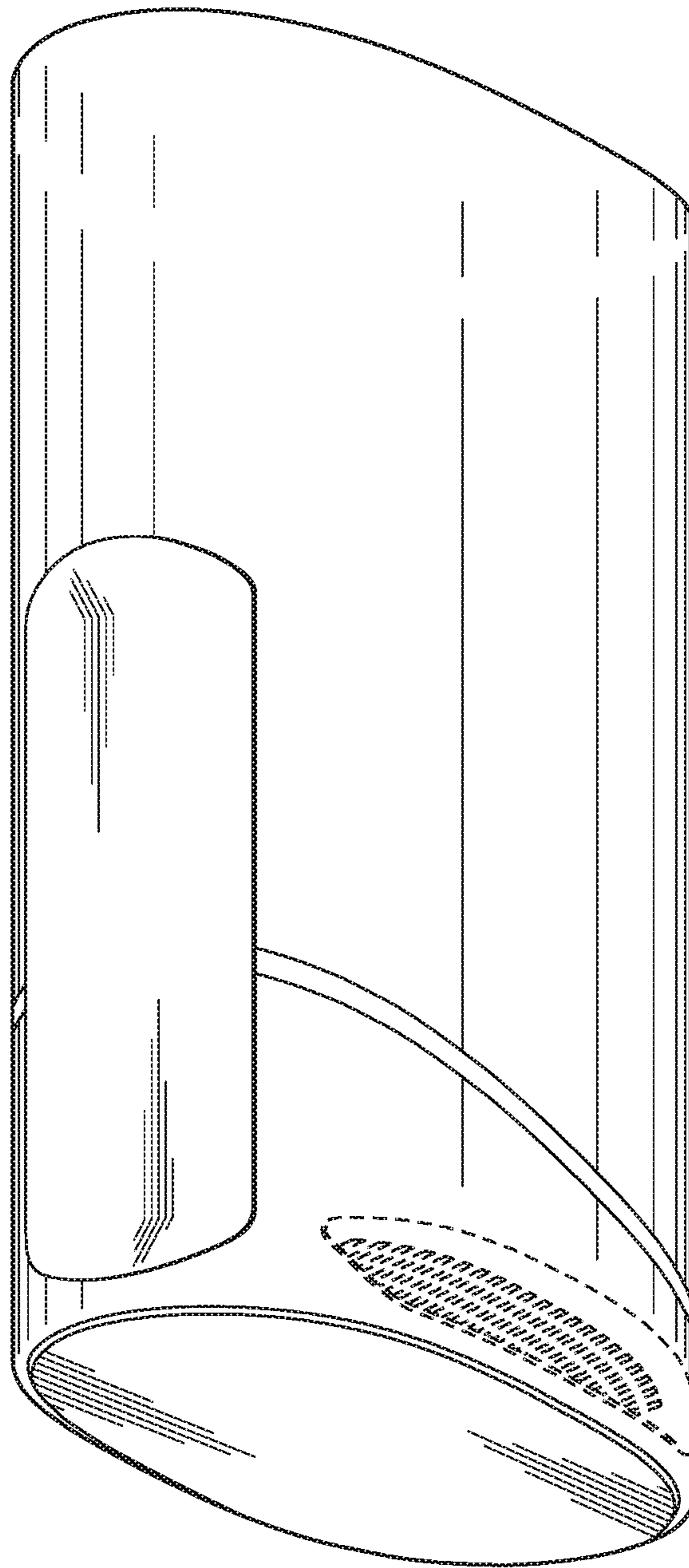

FIG. 10

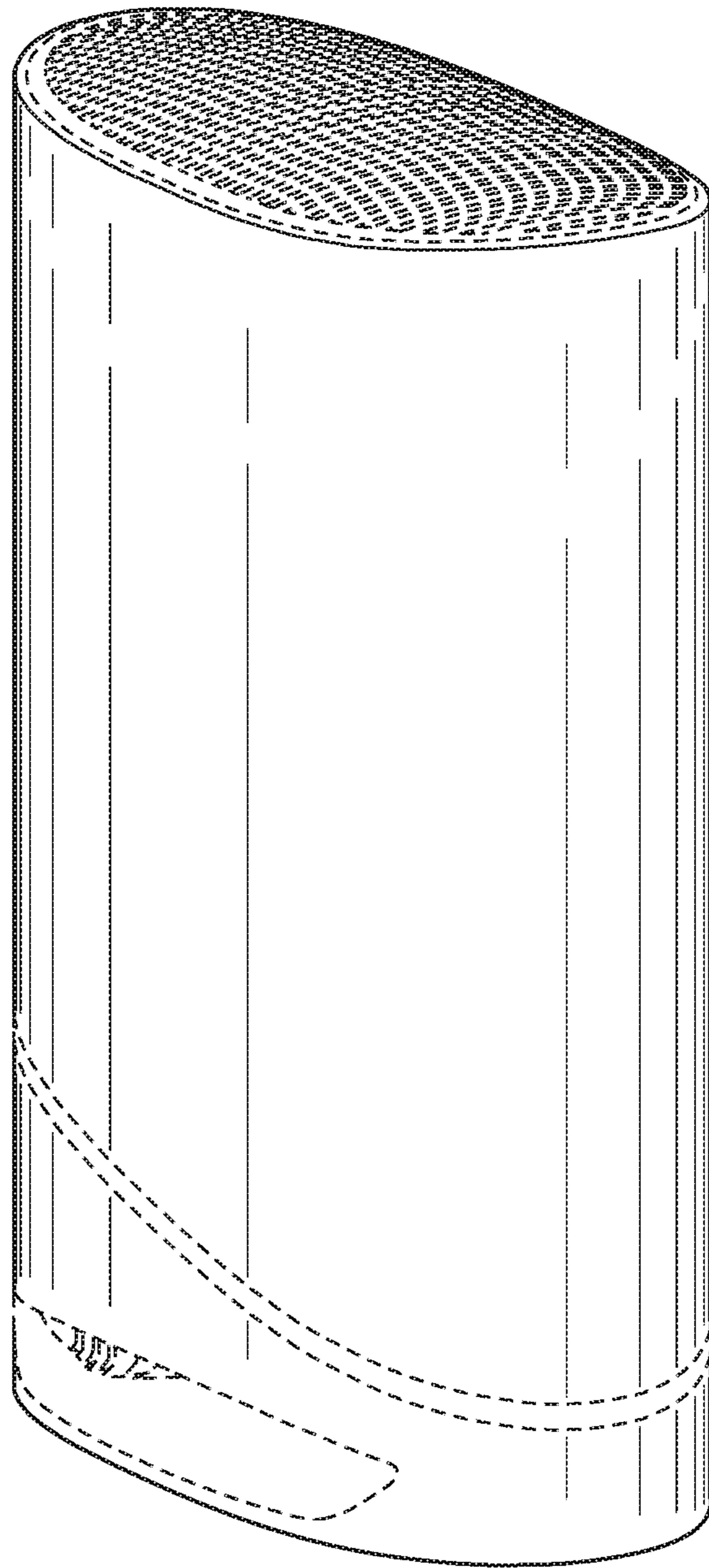

FIG. 11

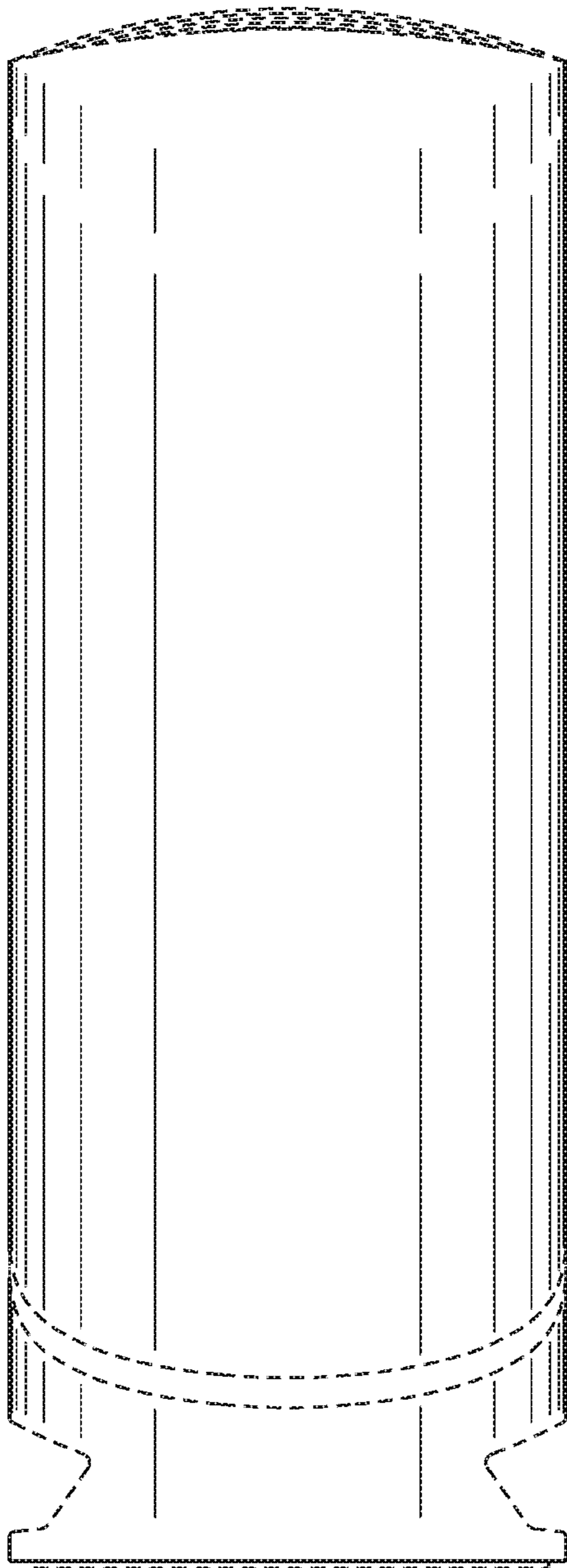

FIG. 12

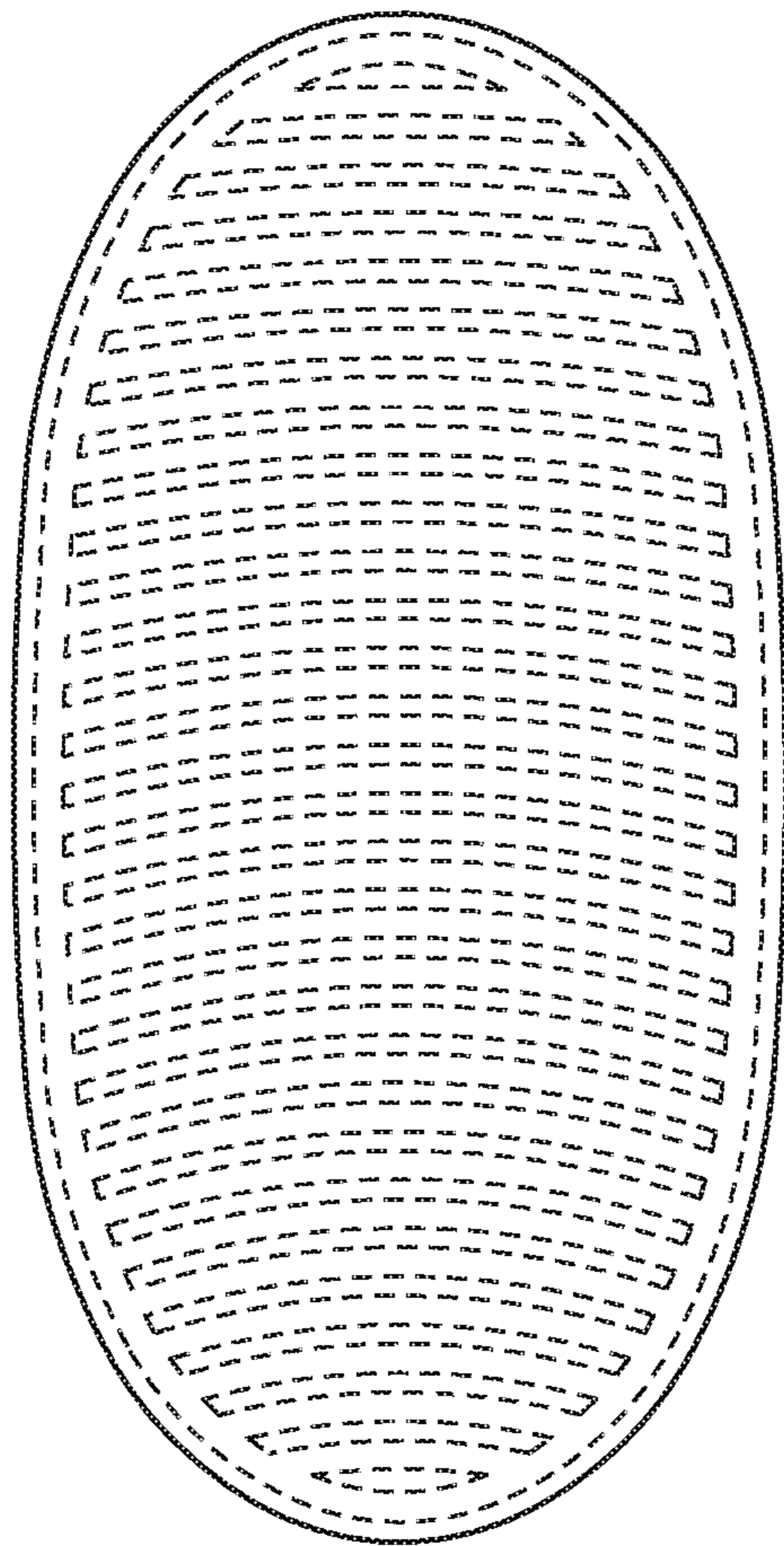

FIG. 13

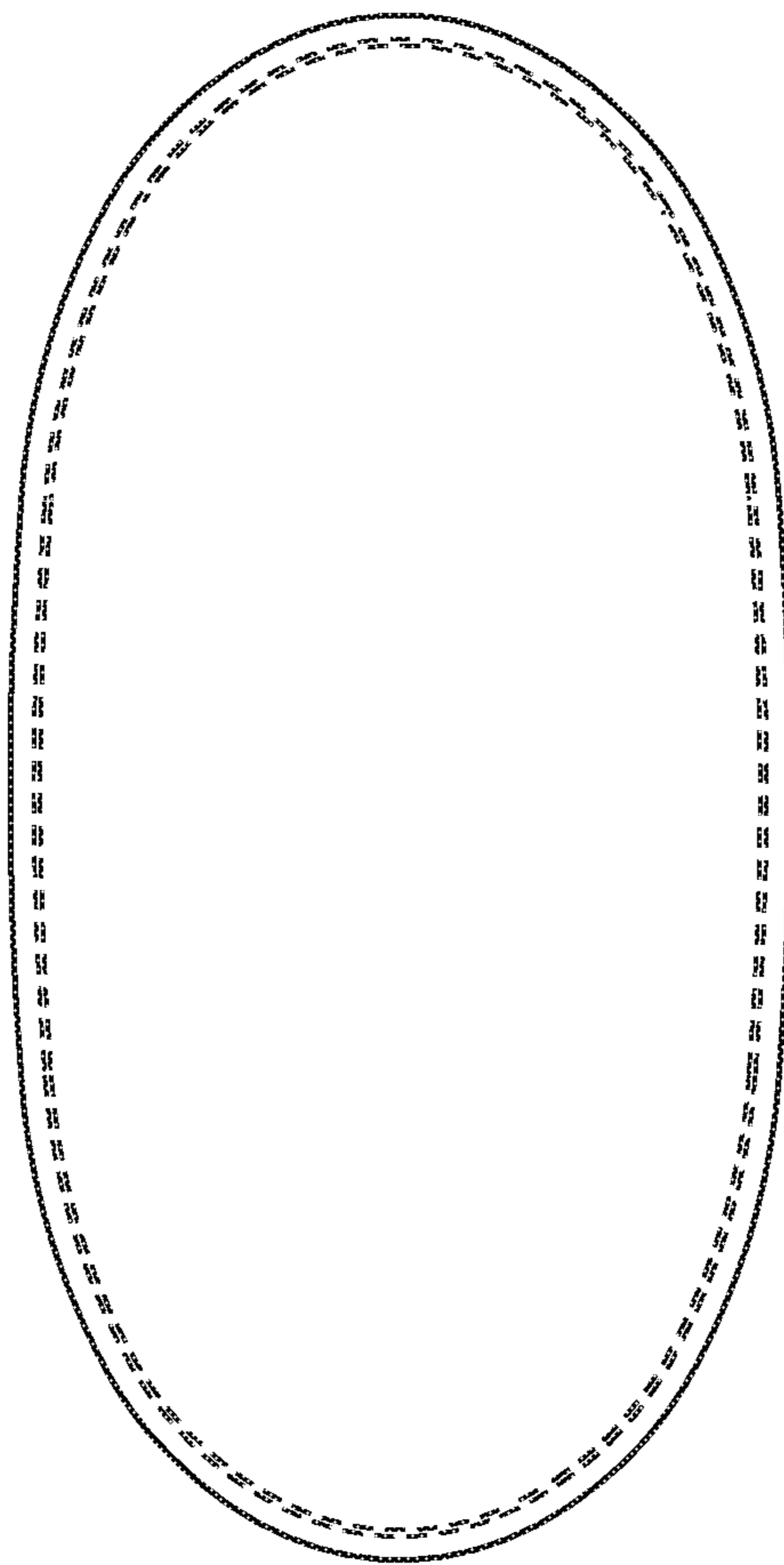

FIG. 14

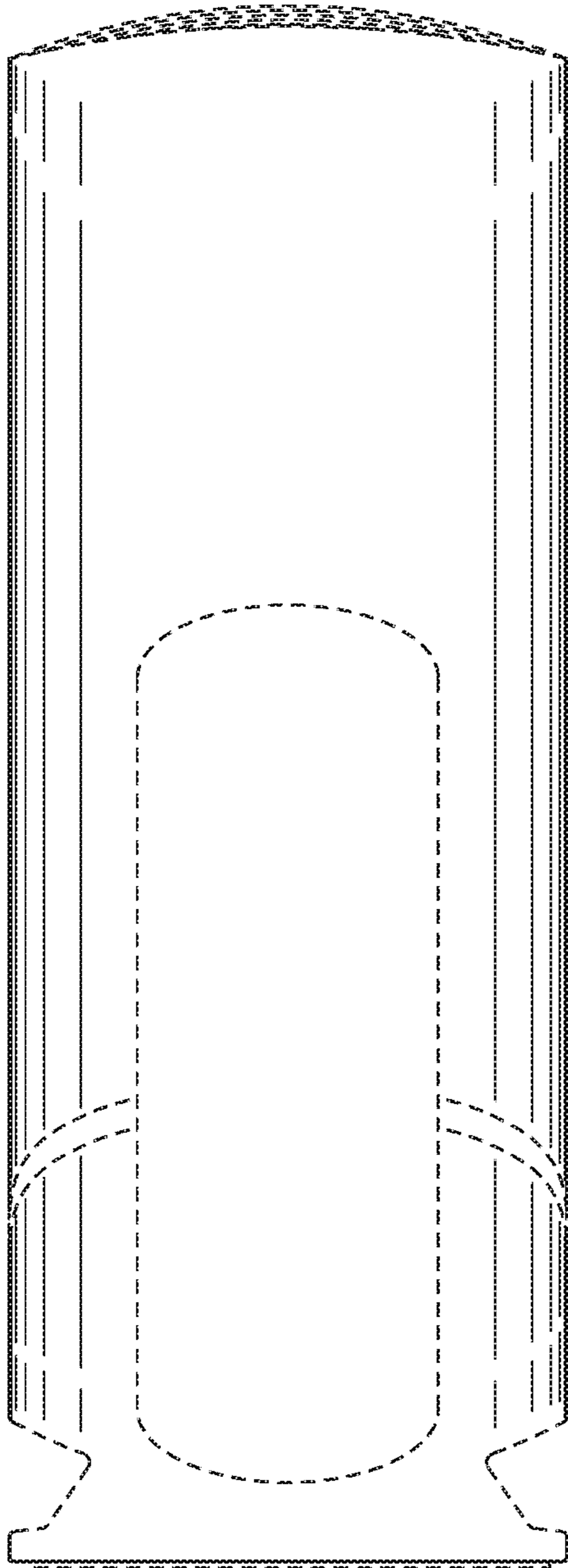

FIG. 15

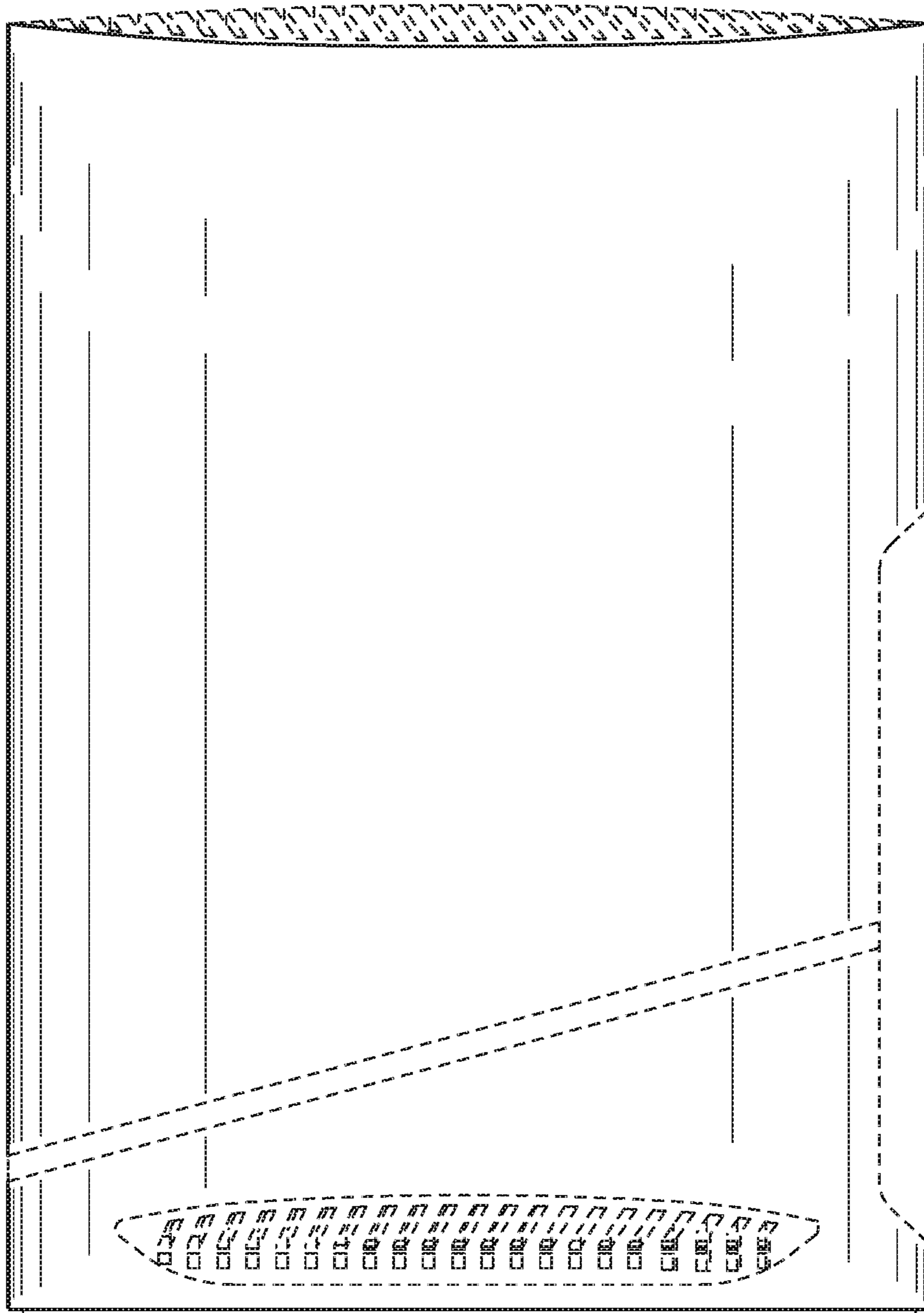

FIG. 16

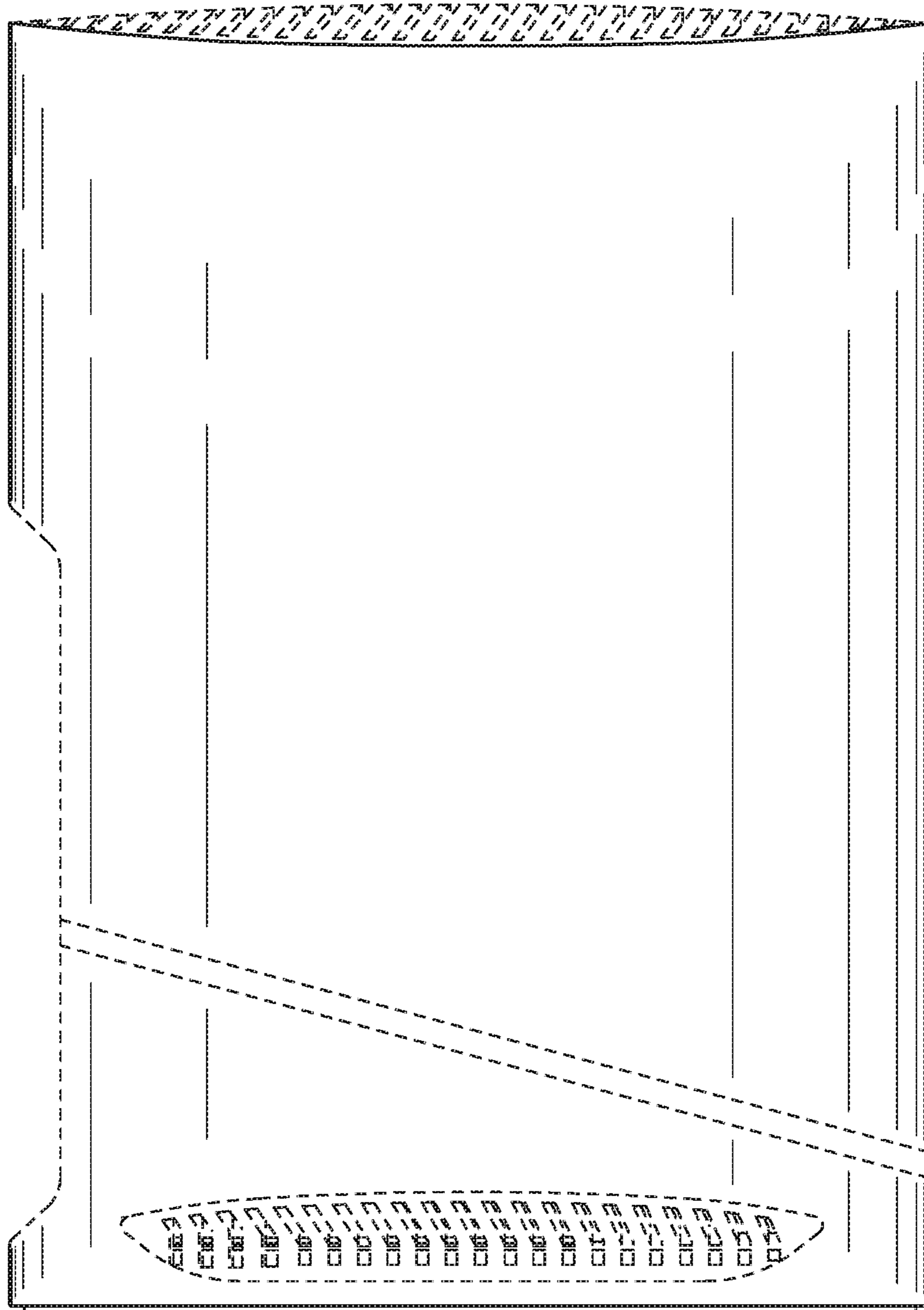

FIG. 17

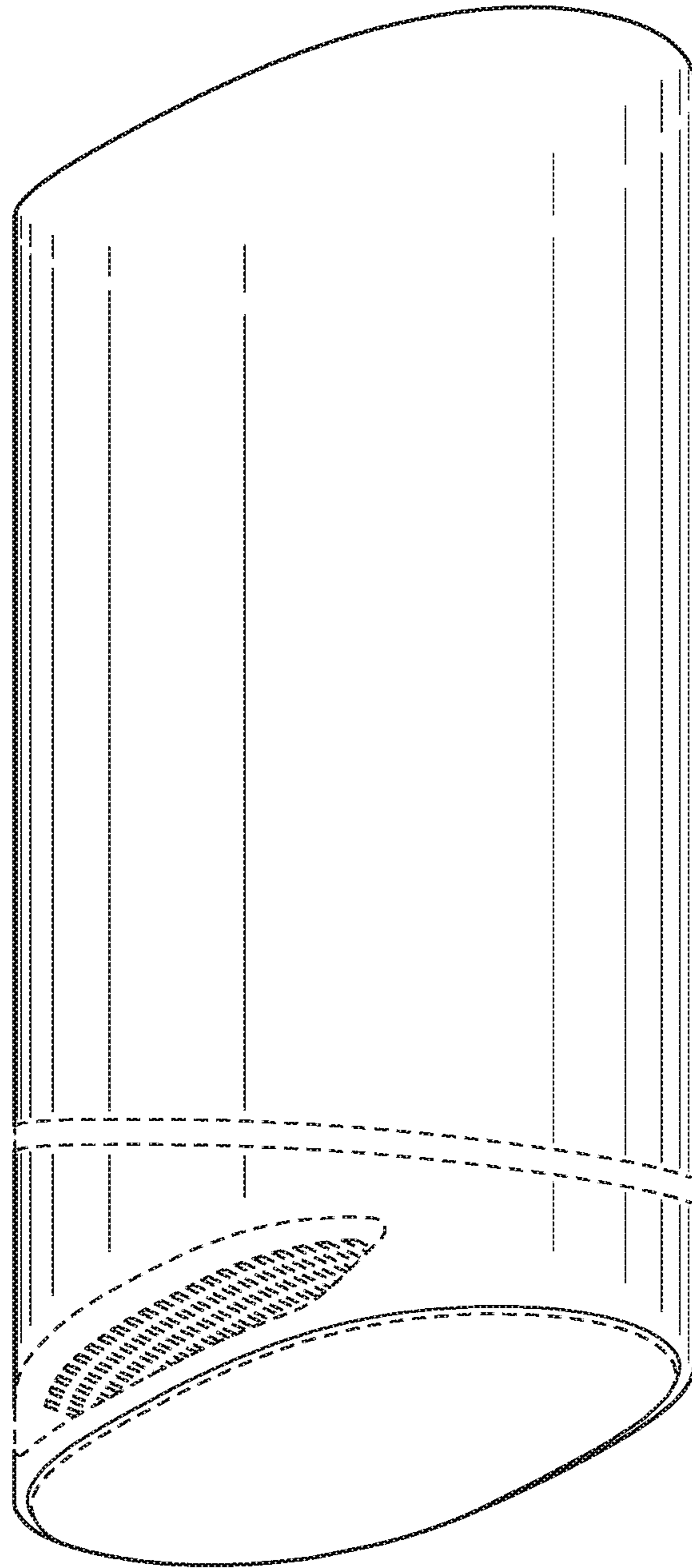

FIG. 18

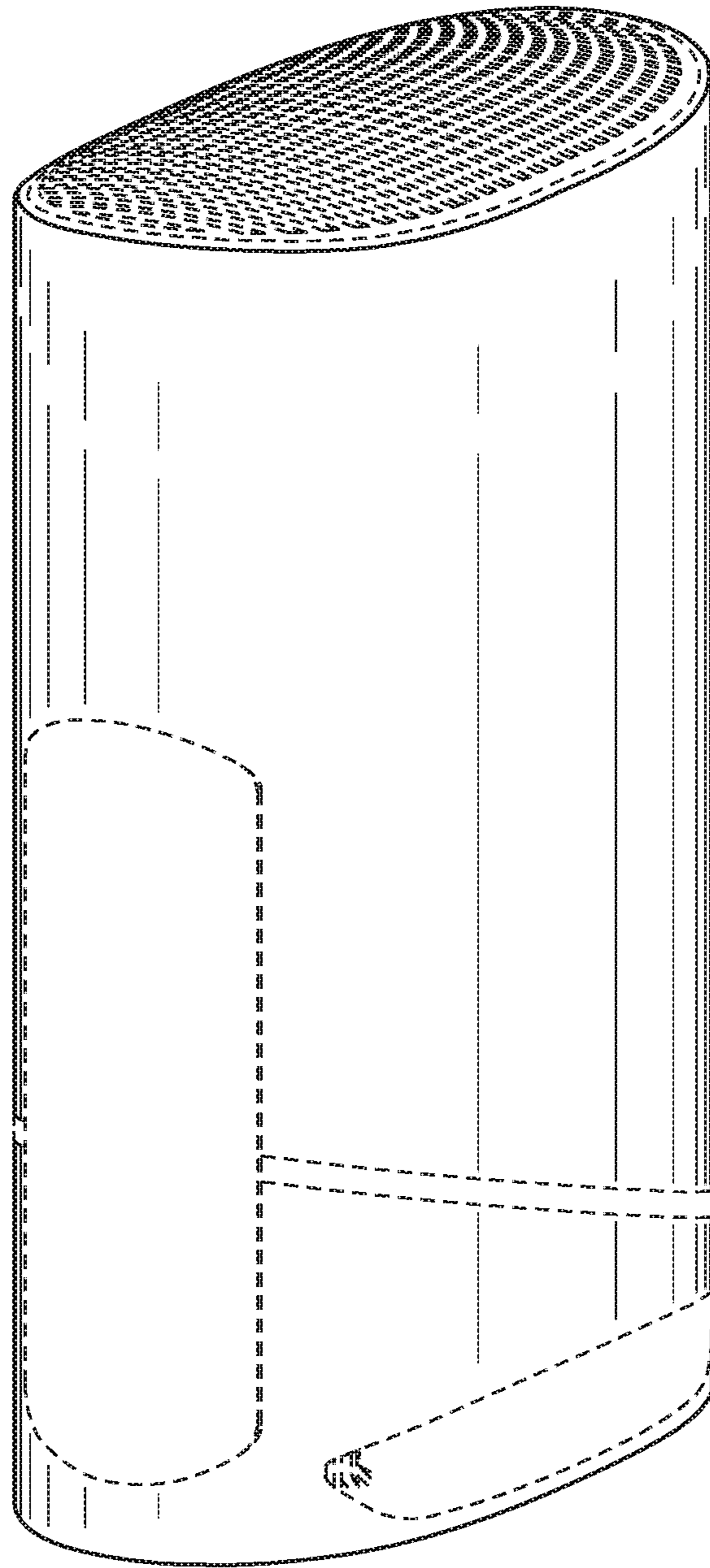

FIG. 19

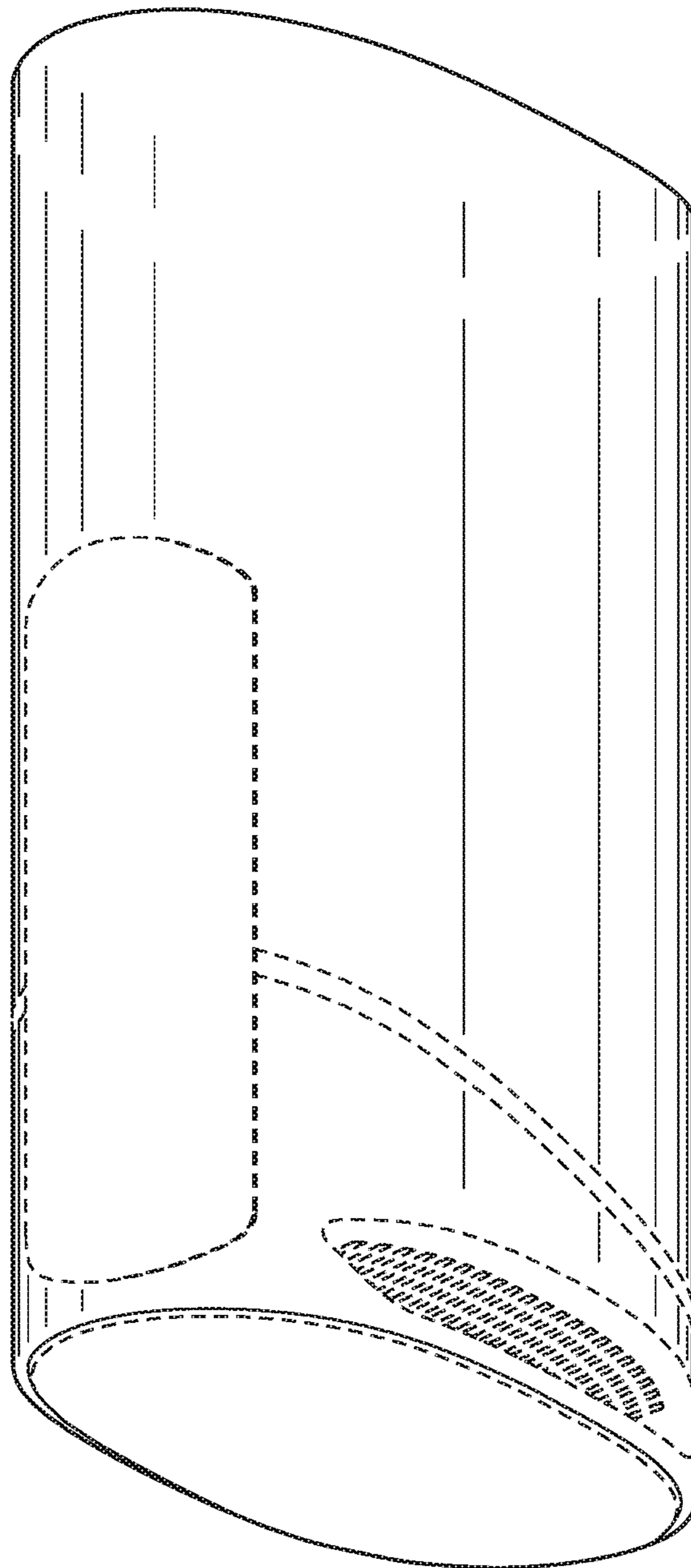

FIG. 20

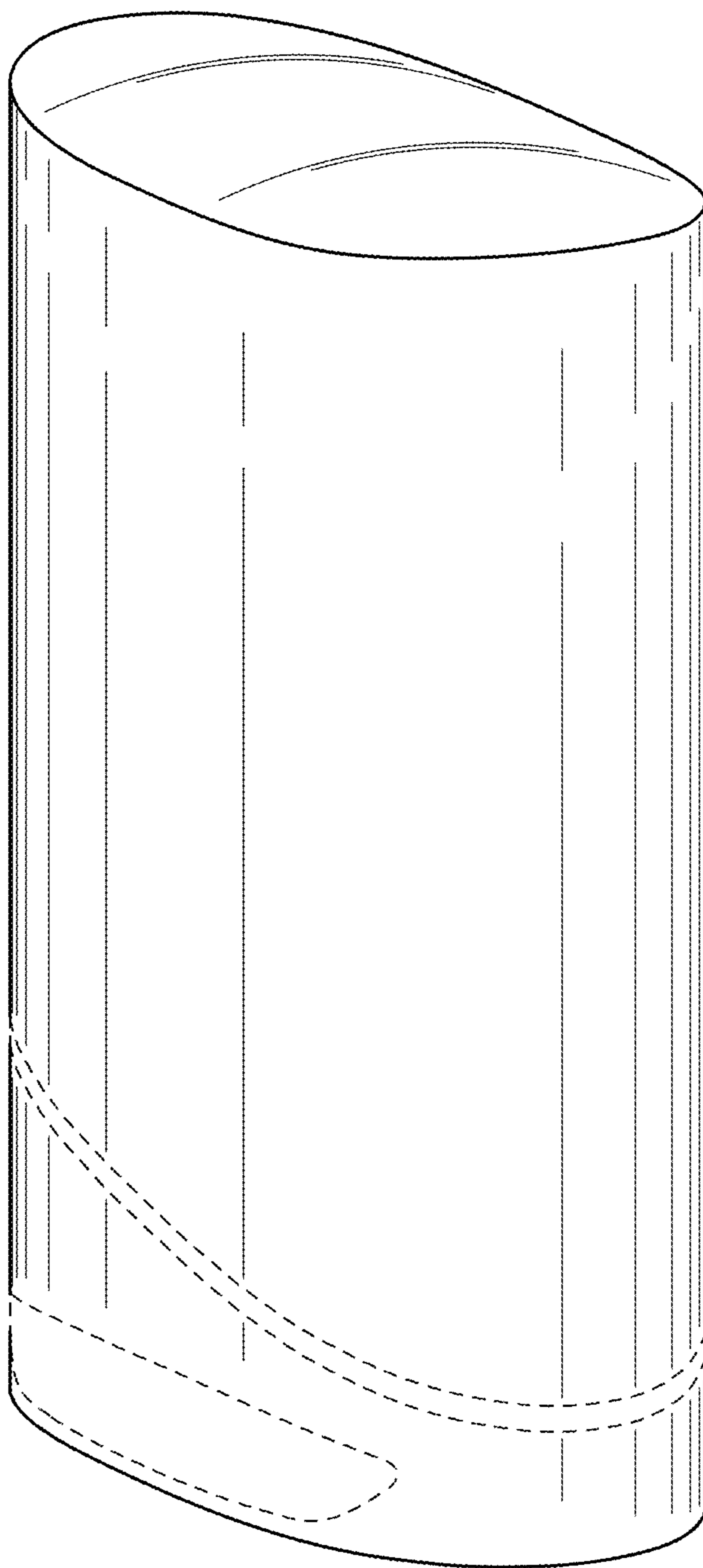

FIG. 21

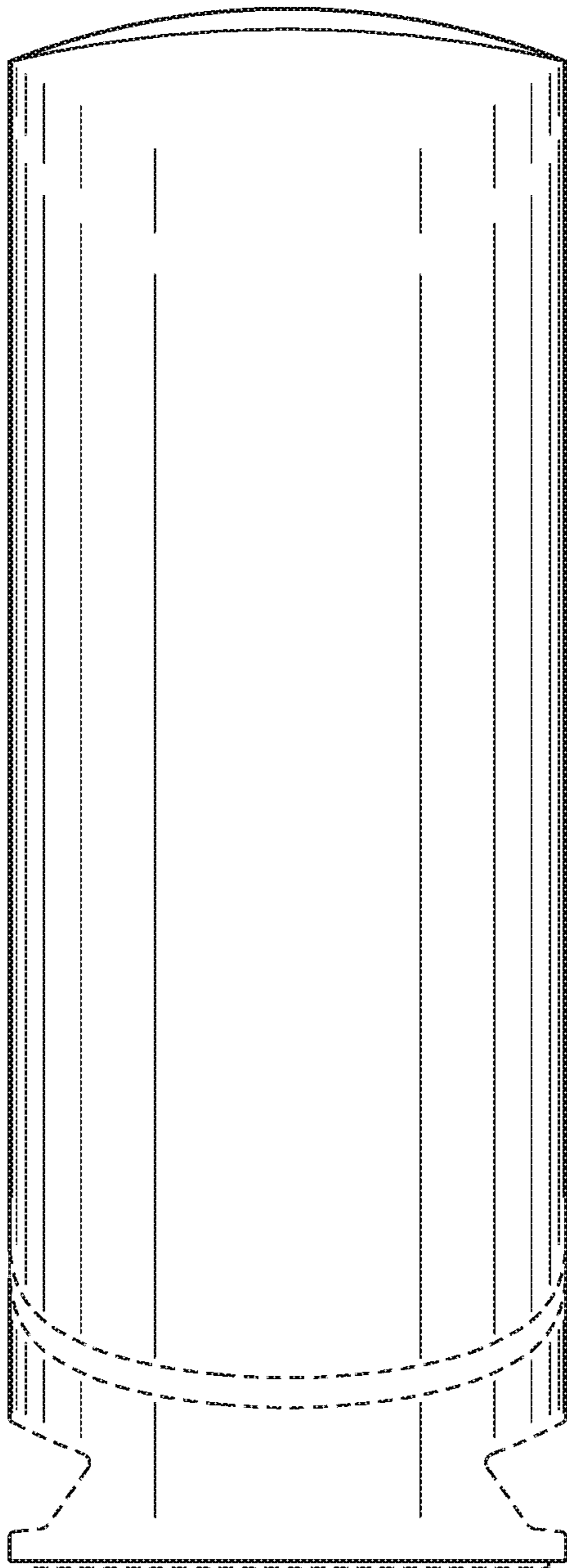

FIG. 22

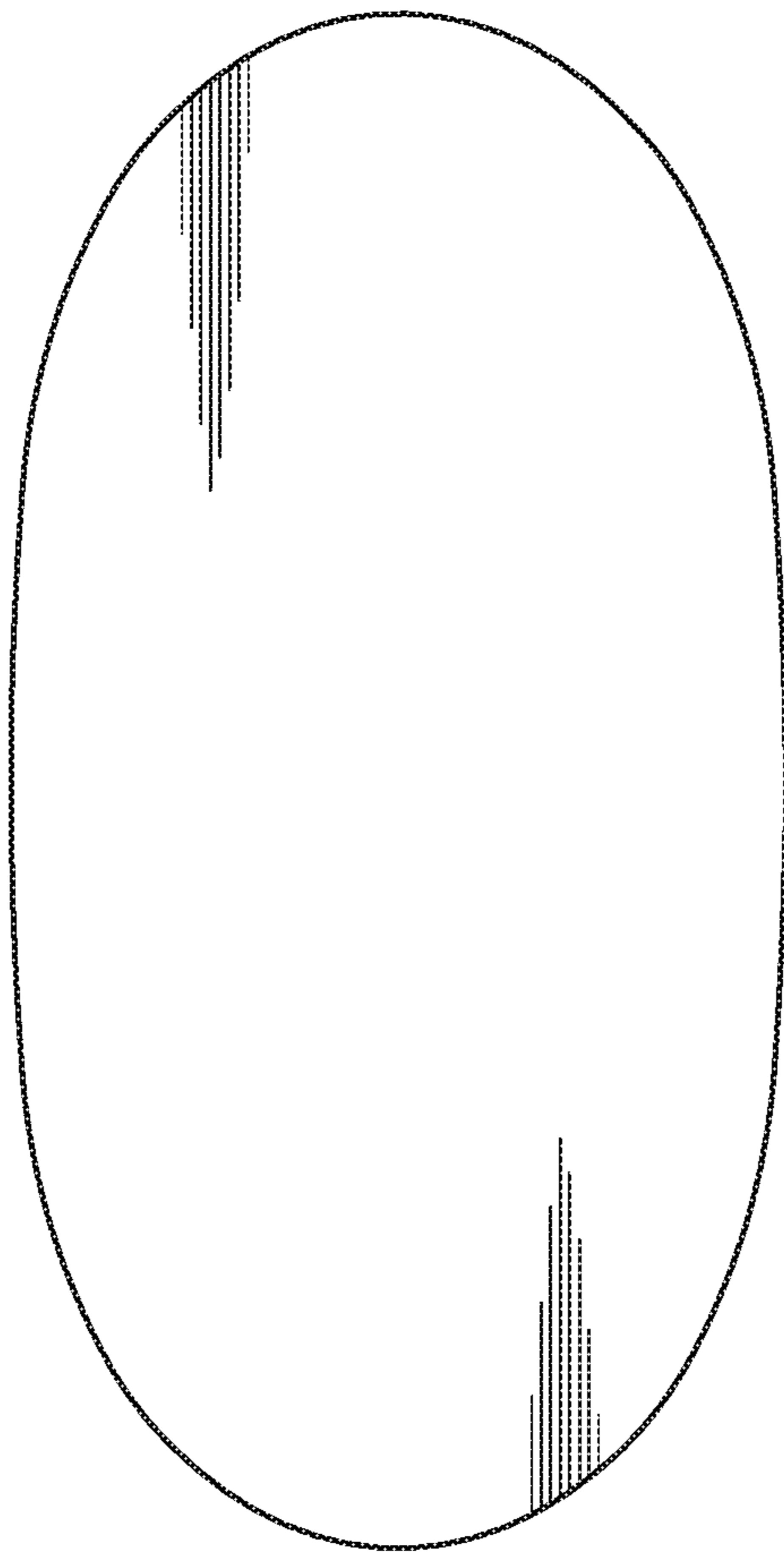

FIG. 23

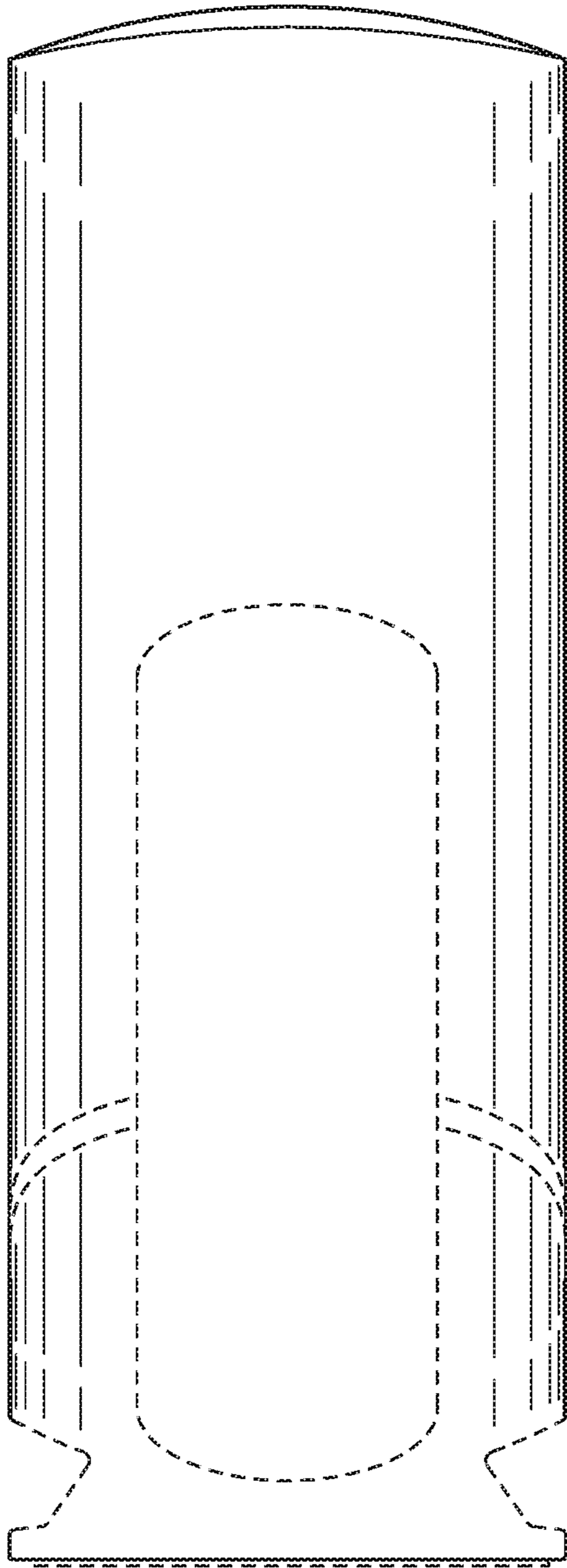

FIG. 24

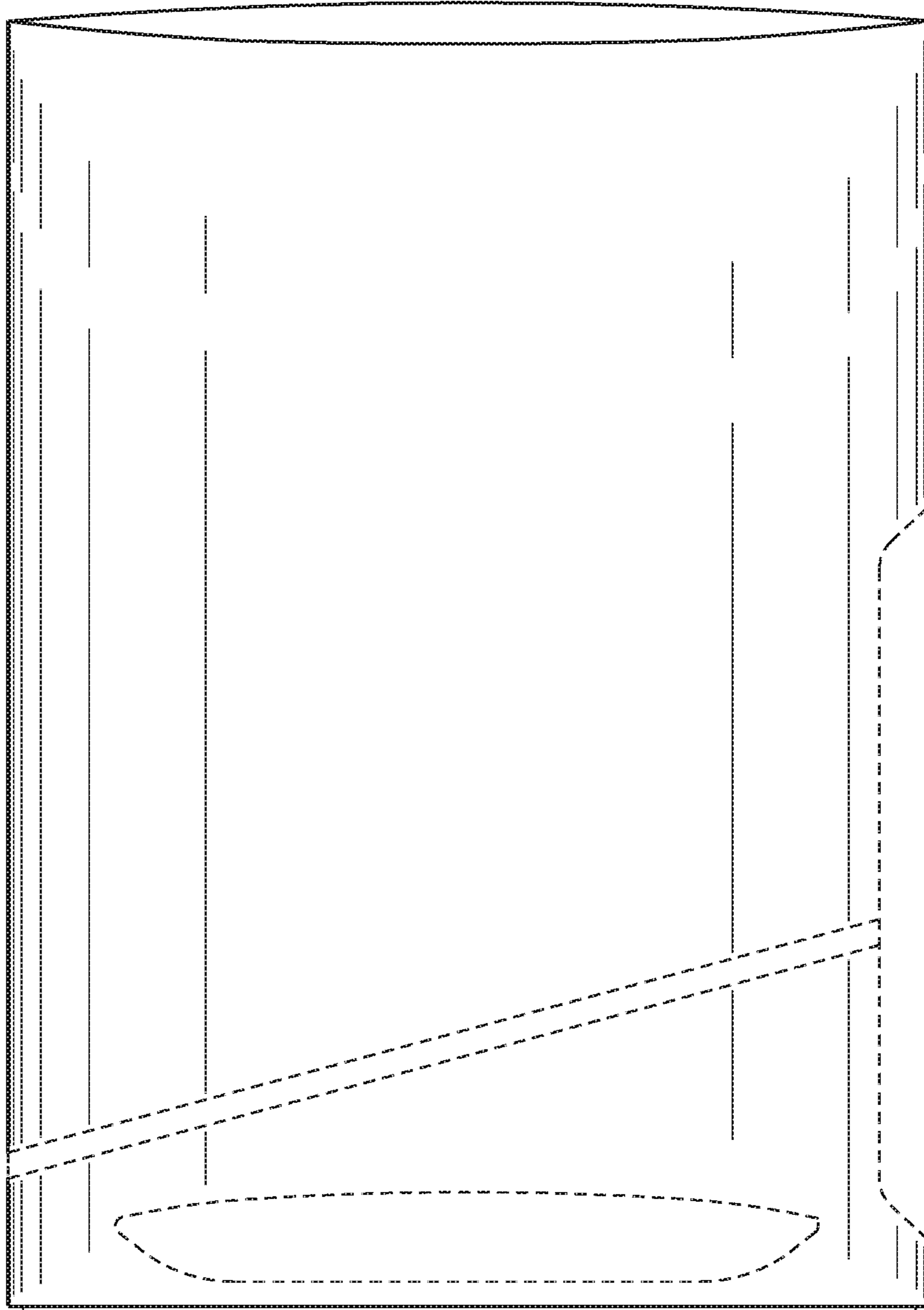

FIG. 25

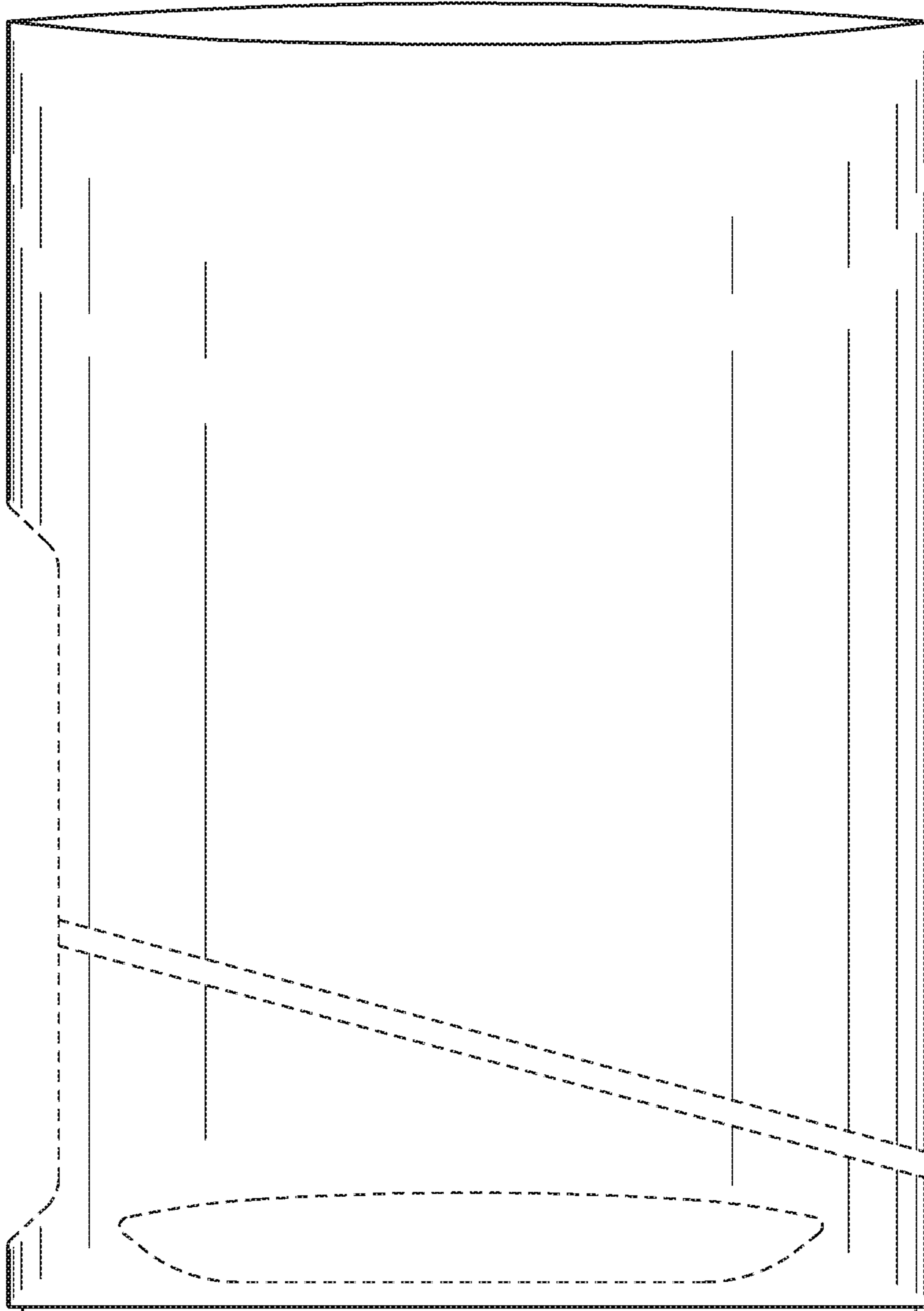

FIG. 26

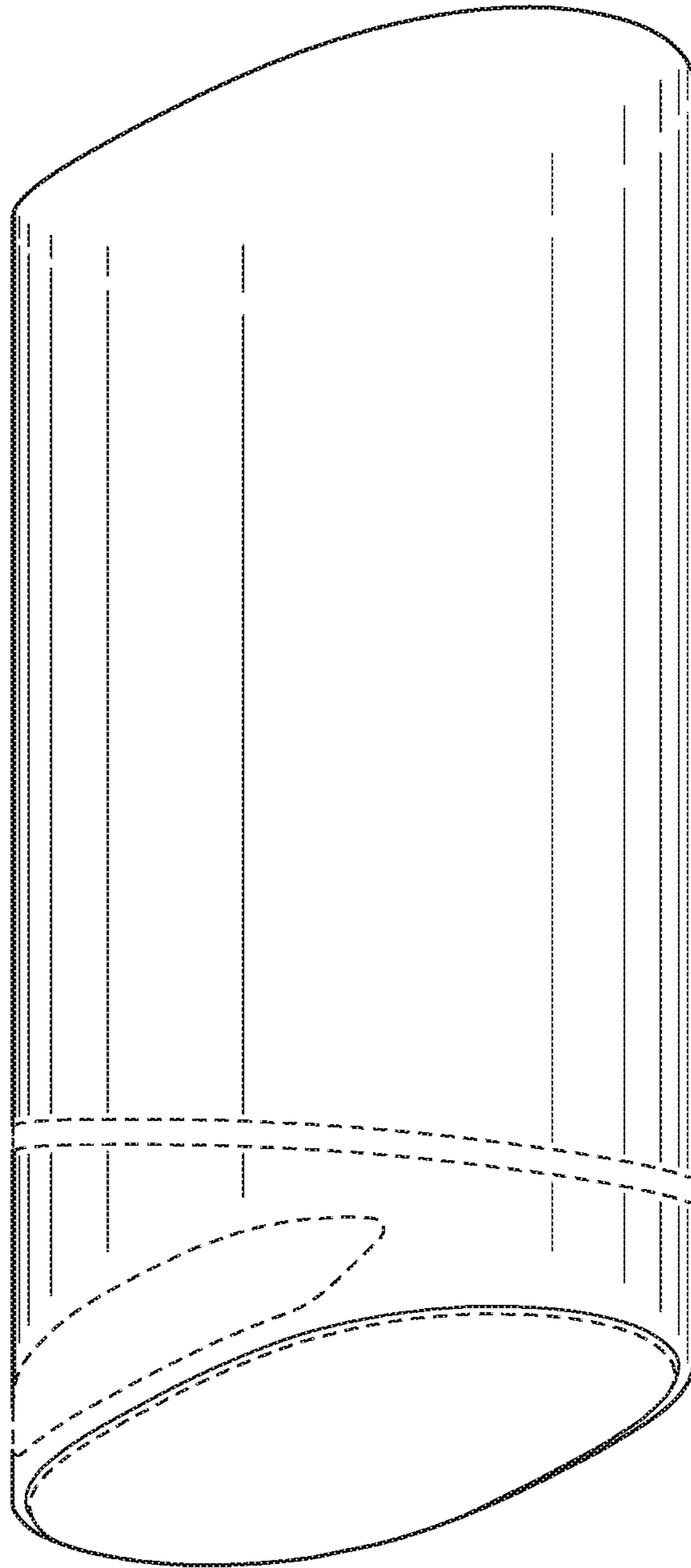

FIG. 27

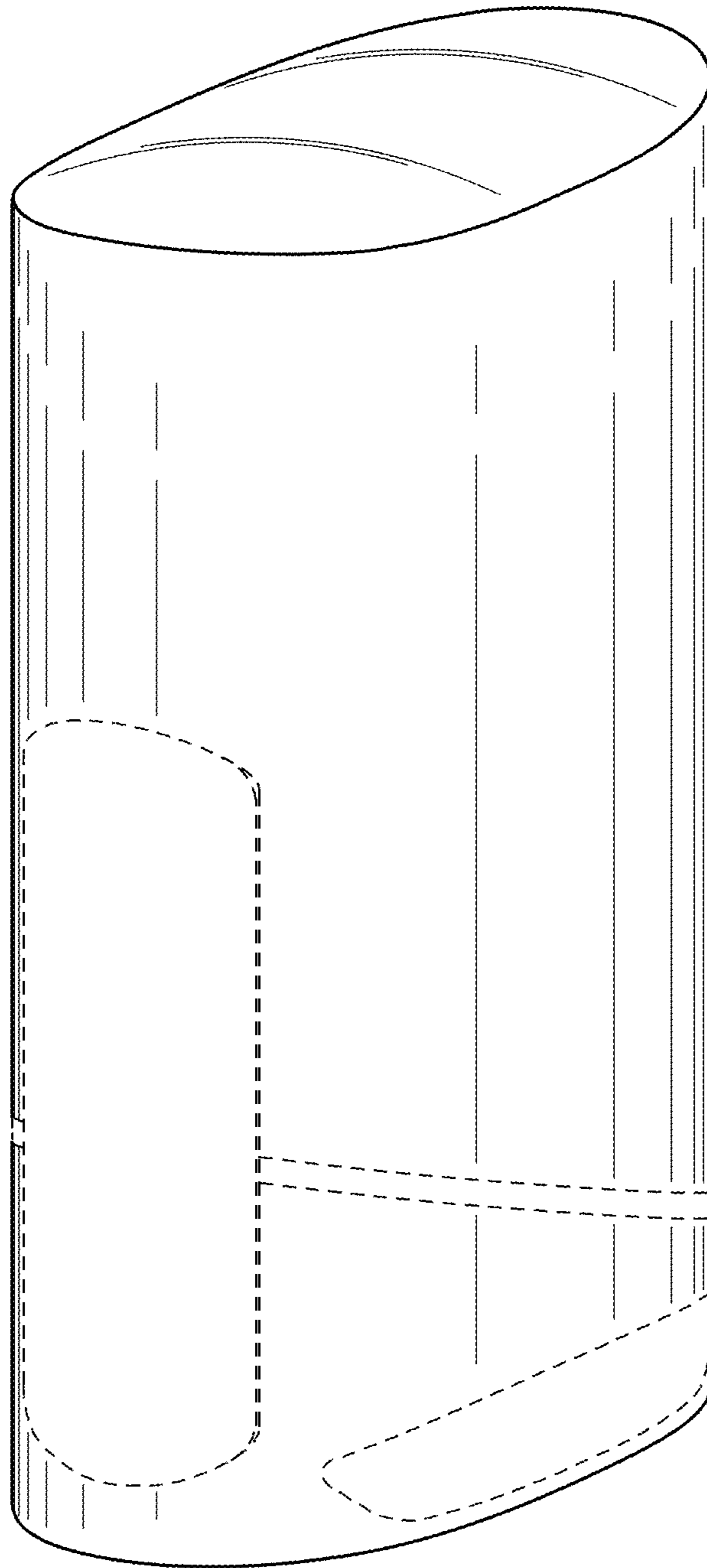

FIG. 28

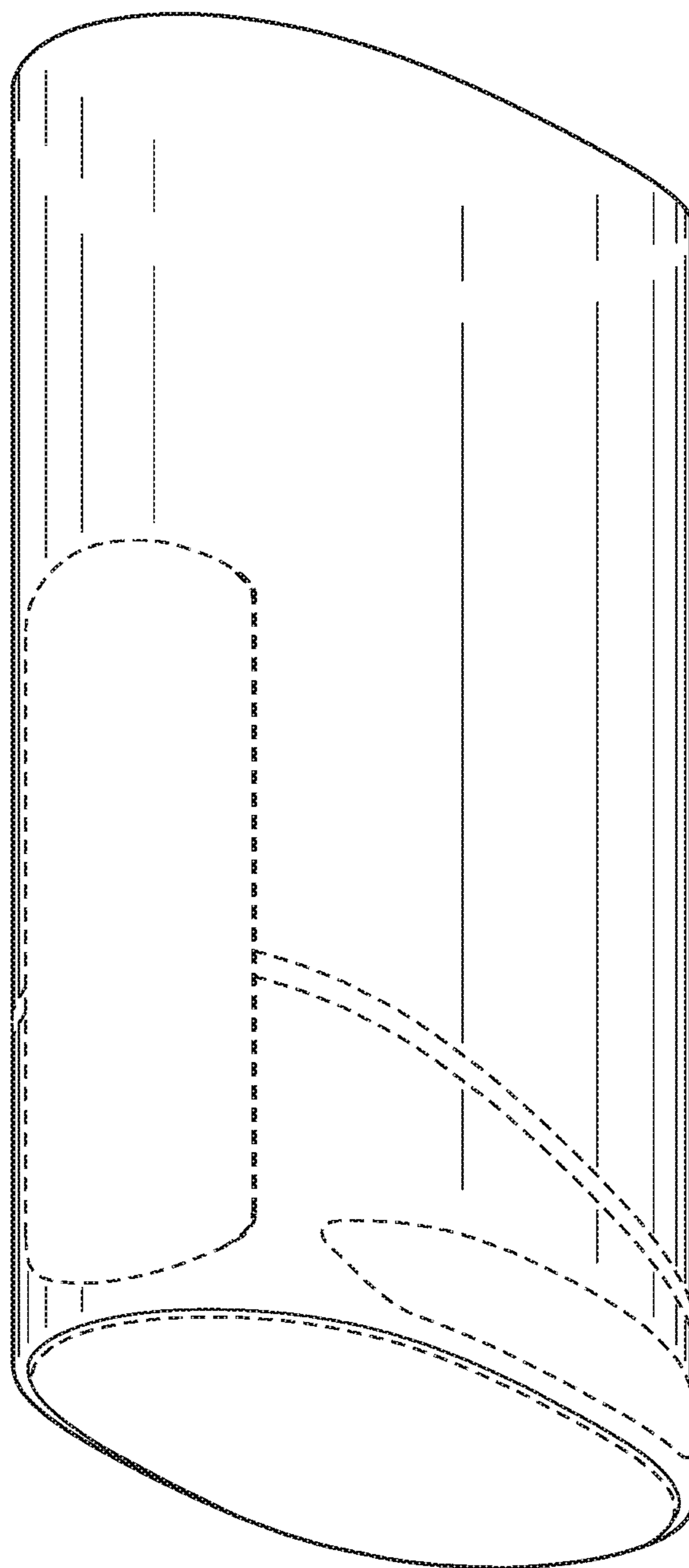

FIG. 29