



US00D938908S

(12) **United States Design Patent** (10) **Patent No.:** **US D938,908 S**  
**Park et al.** (45) **Date of Patent:** **\*\* Dec. 21, 2021**

(54) **CHARGING STATION FOR ROBOT**

(71) Applicant: **LG ELECTRONICS INC.**, Seoul (KR)

(72) Inventors: **Seungjong Park**, Seoul (KR); **Jaeyoung Kim**, Seoul (KR); **Sunghee Han**, Seoul (KR); **Sunil Cho**, Seoul (KR)

(73) Assignee: **LG Electronics Inc.**, Seoul (KR)

(\*\*) Term: **15 Years**

(21) Appl. No.: **35/510,607**

(22) Filed: **Apr. 22, 2020**

(80) **Hague Agreement Data**

Int. Filing Date: **Apr. 22, 2020**

Int. Reg. No.: **DM/207955**

Int. Reg. Date: **Apr. 22, 2020**

Int. Reg. Pub. Date: **Oct. 23, 2020**

(30) **Foreign Application Priority Data**

Nov. 27, 2019 (KR) ..... 30-2019-0057077

(51) **LOC (13) Cl.** ..... **13-02**

(52) **U.S. Cl.**  
USPC ..... **D13/107**

(58) **Field of Classification Search**  
USPC ..... D13/108, 107, 110, 103, 164; D14/434  
CPC ..... H02J 7/00; H03K 17/9625; H04M 1/04  
See application file for complete search history.

(56) **References Cited**

**U.S. PATENT DOCUMENTS**

5,515,044 A \* 5/1996 Glatt ..... H03K 17/9625  
341/20  
D510,066 S \* 9/2005 Hickey ..... D13/108  
D588,059 S \* 3/2009 Fujita ..... D13/108  
D639,735 S \* 6/2011 Lee ..... D13/108  
D675,154 S \* 1/2013 Nam ..... D13/108

D709,446 S \* 7/2014 Haug ..... D13/108  
D777,119 S \* 1/2017 Lin ..... D13/164  
D782,412 S \* 3/2017 Kim ..... D13/108  
D804,414 S \* 12/2017 Tang ..... D13/108  
D810,014 S \* 2/2018 Haranaka ..... D13/108  
D818,433 S \* 5/2018 Ebrahimi Afrouzi ..... D13/108  
D818,951 S \* 5/2018 Ebrahimi Afrouzi ..... D13/108  
D846,494 S \* 4/2019 Takahashi ..... D13/103  
D849,682 S \* 5/2019 Dou ..... D13/108  
D860,934 S \* 9/2019 Ebrahimi Afrouzi ..... D13/108  
D879,709 S \* 3/2020 Lu ..... D13/108  
D905,633 S \* 12/2020 Yoon ..... D13/108  
D922,389 S \* 6/2021 Liu ..... D14/434  
D926,130 S \* 7/2021 Huang ..... D13/110  
D929,326 S \* 8/2021 Wang ..... D13/110

(Continued)

**OTHER PUBLICATIONS**

“Docking . . . ” reference dated Nov. 5, 2021 on the internet at:  
[https://www.bissell.com/docking-station-for-select-robot-vacs-1612033.html?languageok=1&utm\\_source=google&utm\\_medium=cpc&utm\\_campaign=%5Badv:BISELL%5D%5Bcou:US%5D%5Bini:Portfolio%5D%5Bplt:Google%5D%5Bfun:Engage%5D%5Bstr:PLA%5D%5Btgt:NB%5D%5Bc.\\*](https://www.bissell.com/docking-station-for-select-robot-vacs-1612033.html?languageok=1&utm_source=google&utm_medium=cpc&utm_campaign=%5Badv:BISELL%5D%5Bcou:US%5D%5Bini:Portfolio%5D%5Bplt:Google%5D%5Bfun:Engage%5D%5Bstr:PLA%5D%5Btgt:NB%5D%5Bc.*)

(Continued)

*Primary Examiner* — Rhea Shields

(74) *Attorney, Agent, or Firm* — Birch, Stewart, Kolasch & Birch, LLP

(57) **CLAIM**

The ornamental design for a charging station for robot, as shown and described.

**DESCRIPTION**

1. Charging station for robot  
1.1 : Perspective  
1.2 : Front  
1.3 : Back  
1.4 : Left

(Continued)

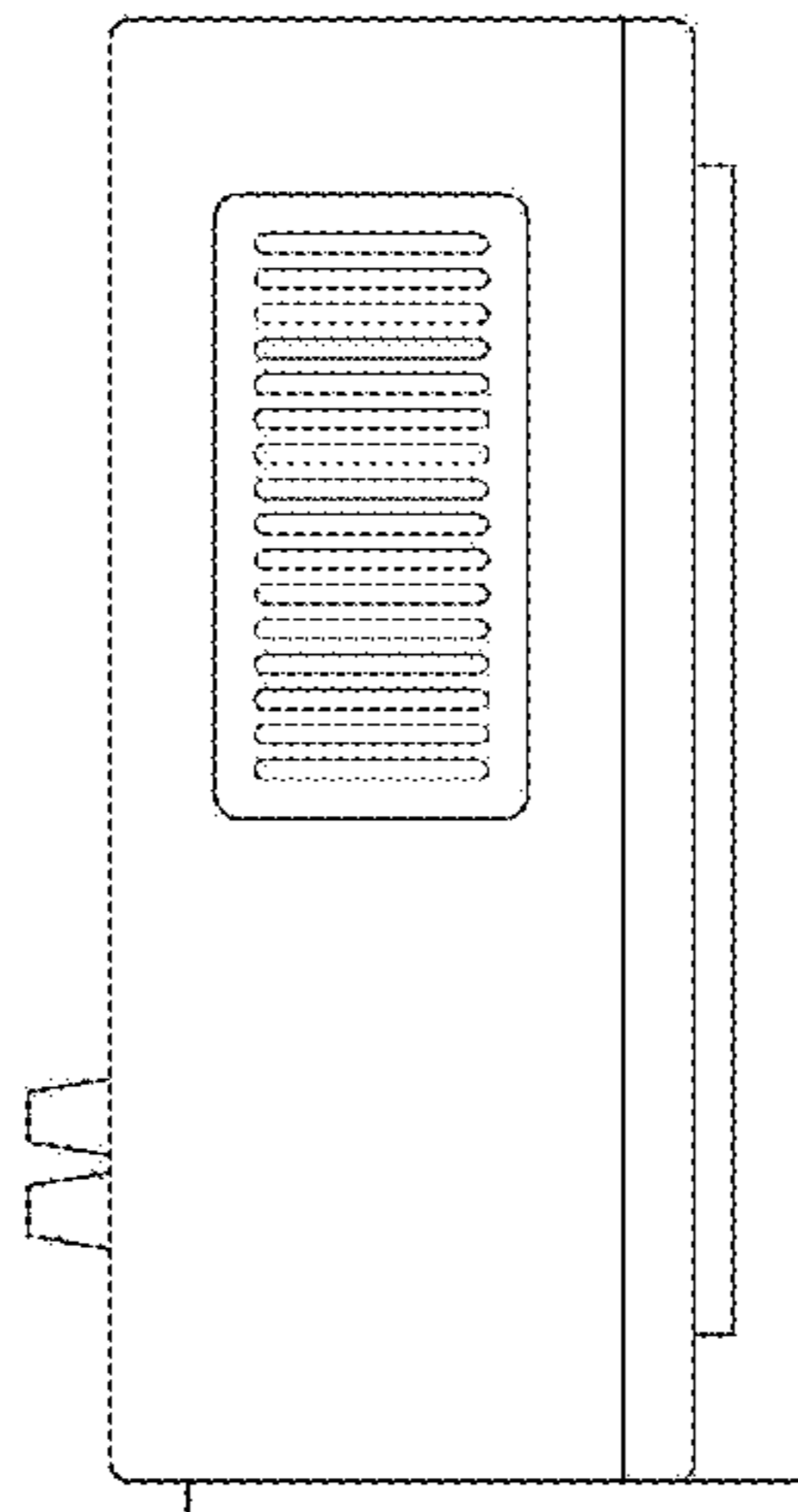

1.5 : Right  
1.6 : Top  
1.7 : Bottom

**1 Claim, 7 Drawing Sheets**

(56) **References Cited**

U.S. PATENT DOCUMENTS

D929,327 S \* 8/2021 Wang ..... D13/110  
D931,921 S \* 9/2021 Haddadin ..... D15/199  
2014/0191707 A1 \* 7/2014 Carreon ..... H04M 1/04  
320/107  
2019/0006861 A1 \* 1/2019 Mikami ..... H02J 7/00

OTHER PUBLICATIONS

“Original . . . ” reference dated Nov. 5, 2021 on the internet at:  
<https://www.geekbuying.com/item/Xiaomi-VIOMI-V2-Robot-Vacuum-Cleaner-Charging-Base-Black-417792.html>.\*

\* cited by examiner

1.1

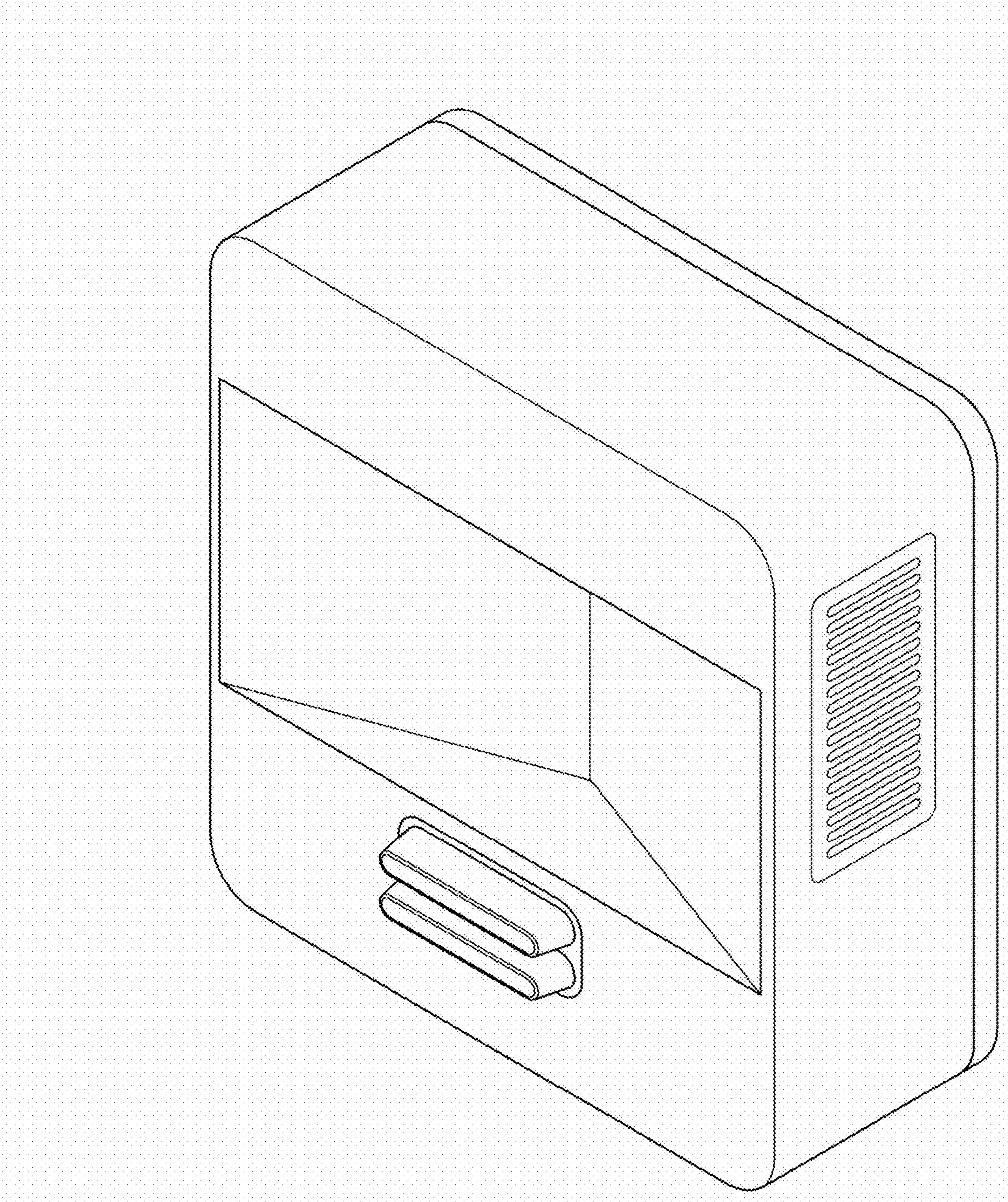



1.2

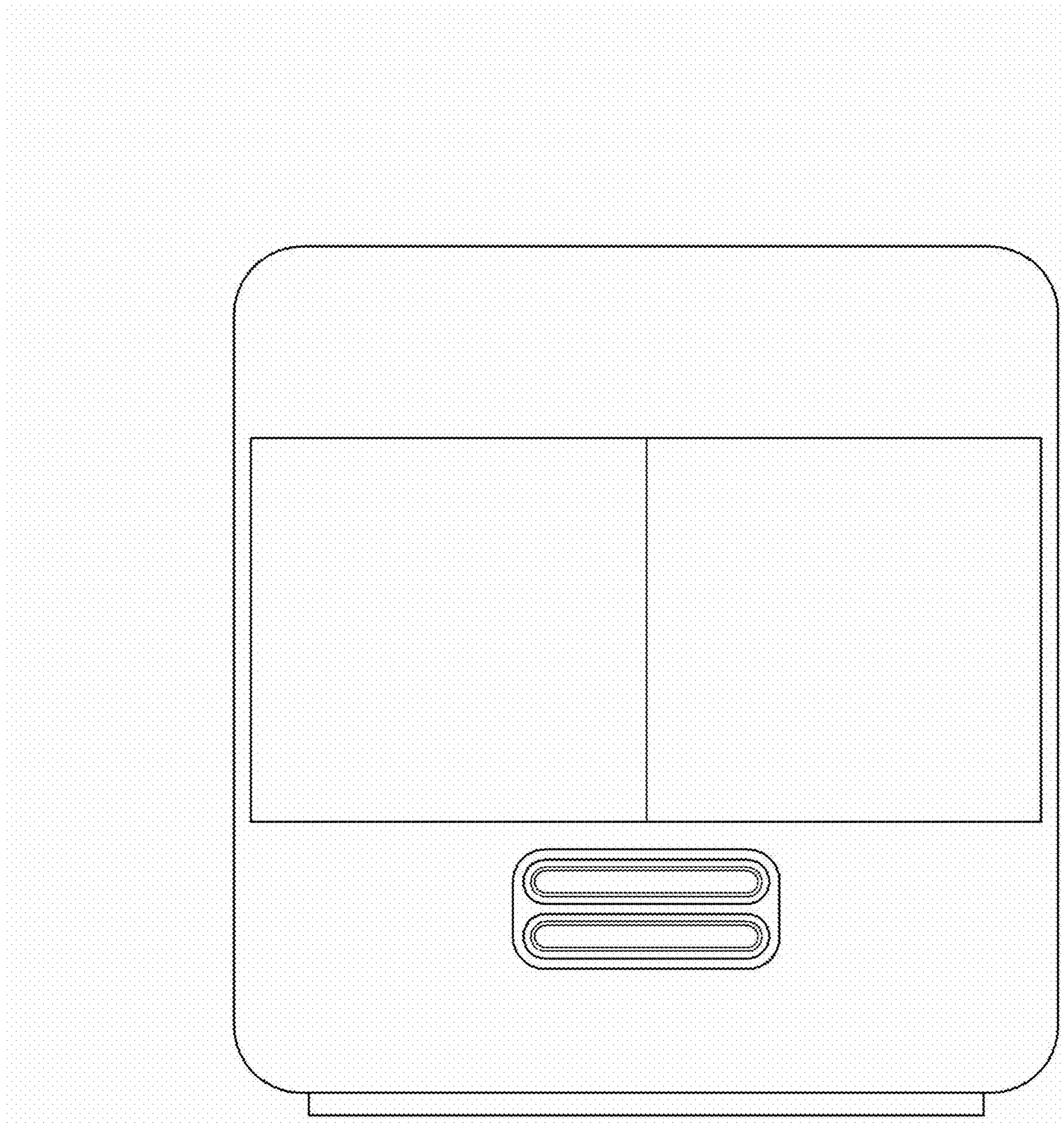

1.3

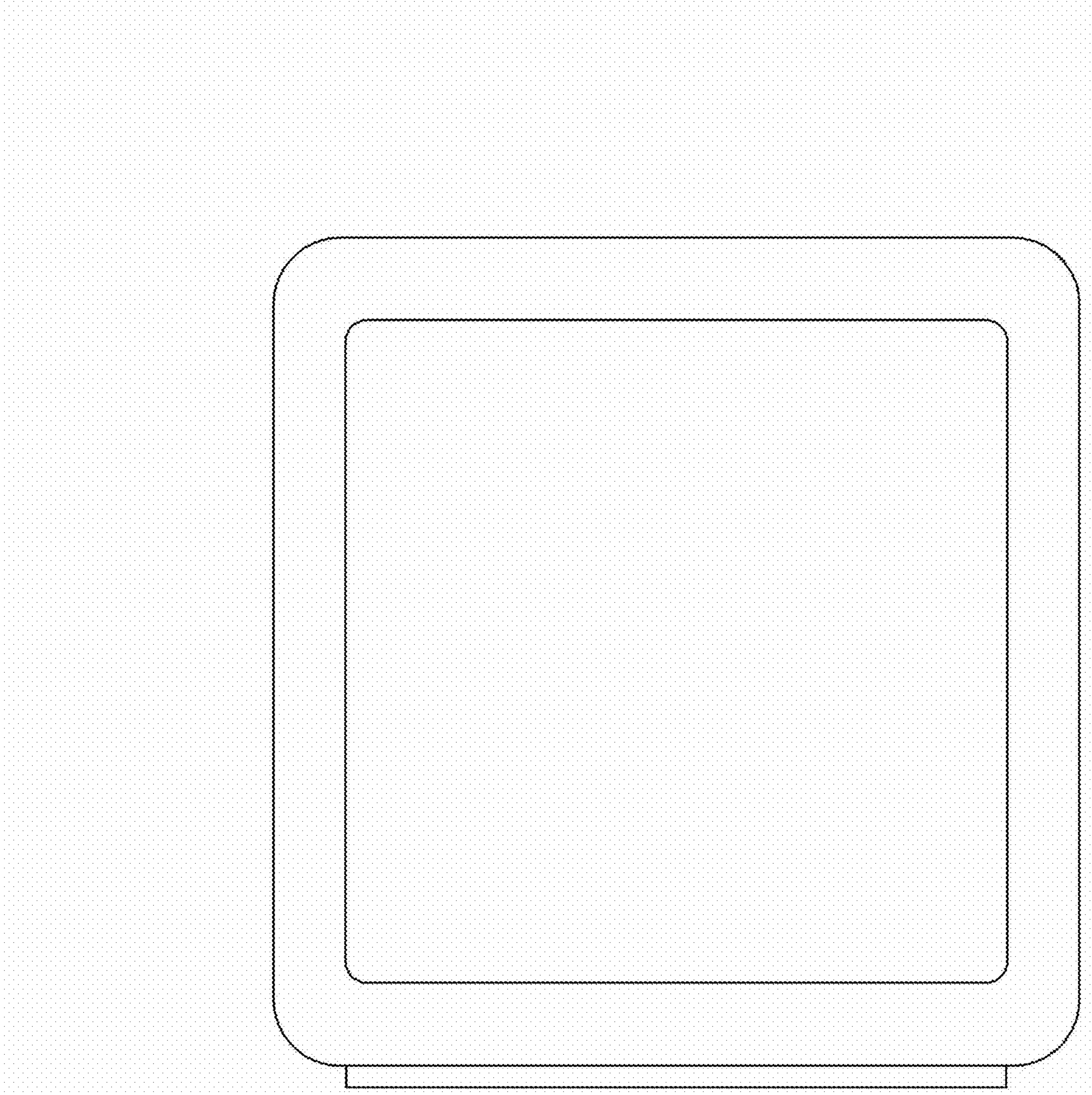

1.4

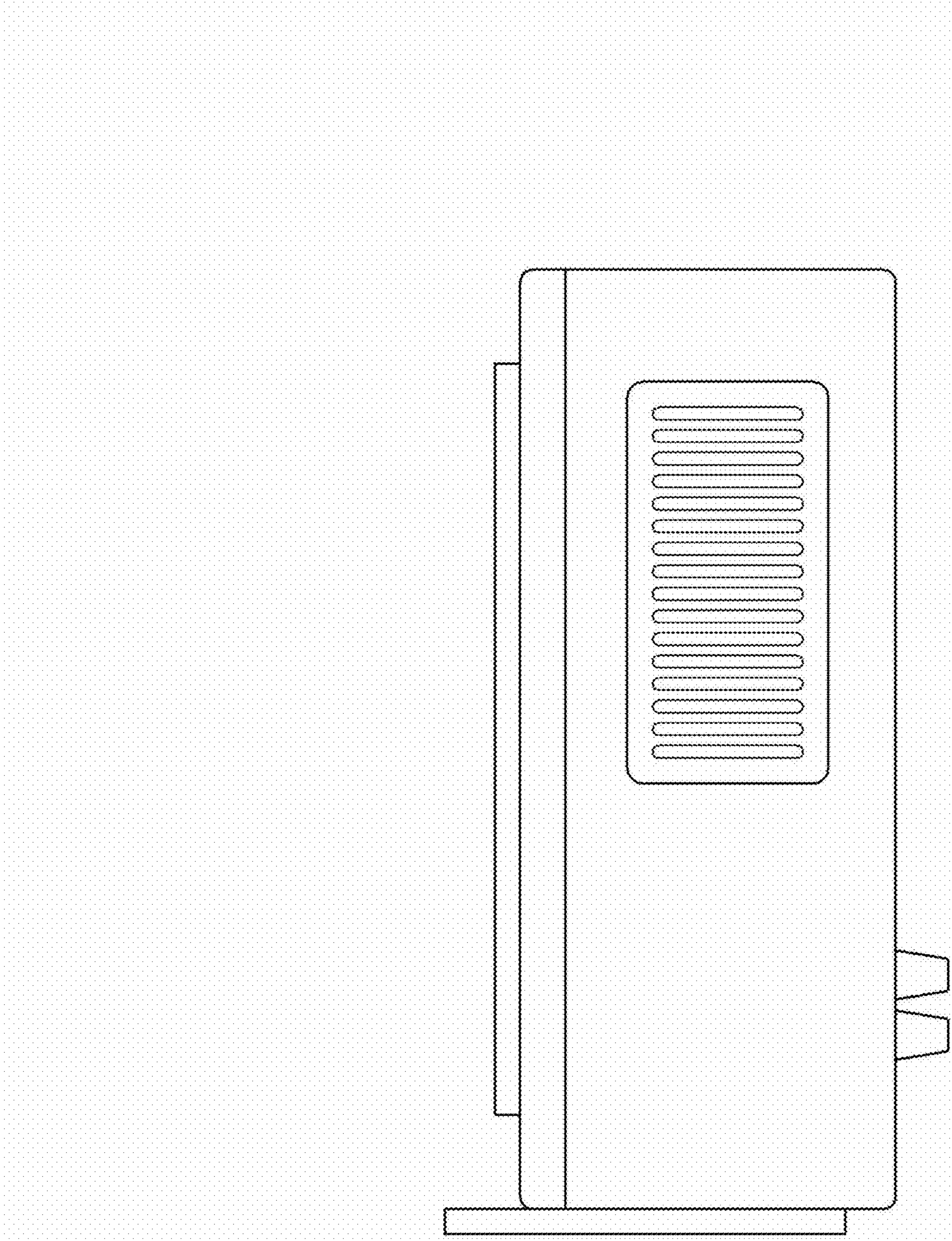

1.5

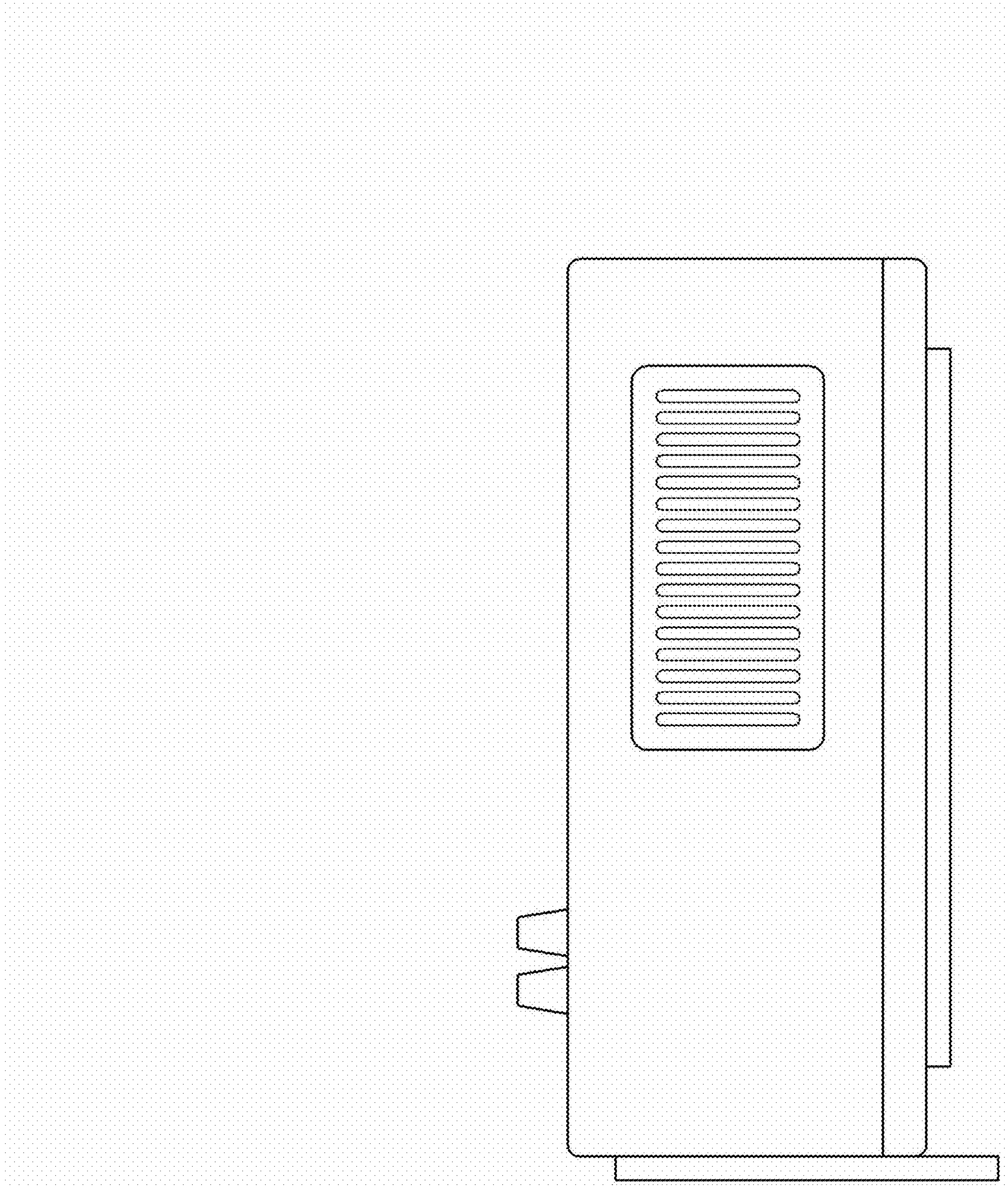



1.6

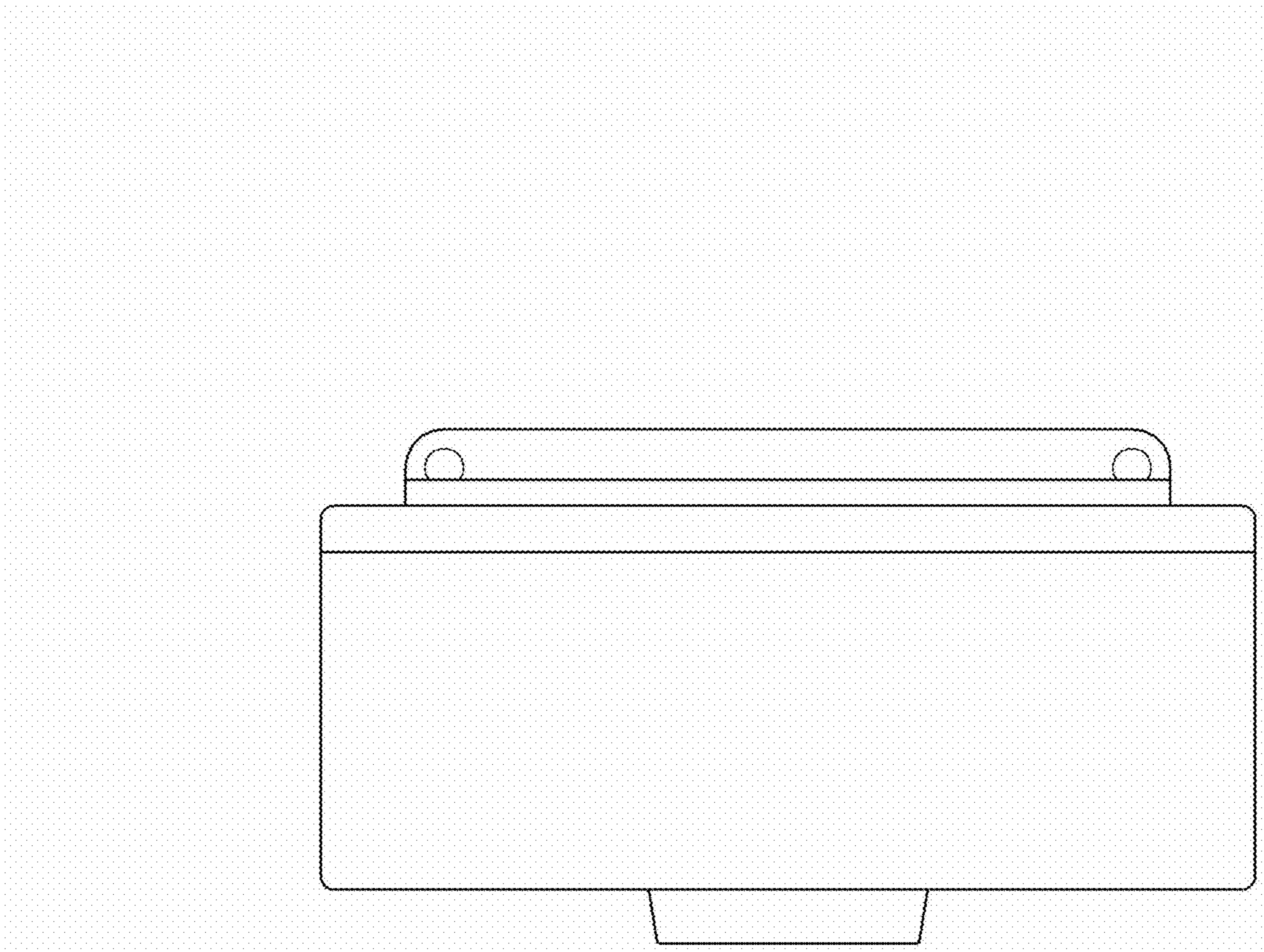



1.7

