



US00D938779S

(12) **United States Design Patent** (10) **Patent No.:** **US D938,779 S**
Wang (45) **Date of Patent:** **** Dec. 21, 2021**

(54) **COOKWARE HANDLE**
(71) Applicant: **NINGBO RE-COOK IMP. & EXP. CO., LTD**, Ningbo (CN)
(72) Inventor: **Jia Wang**, Ningbo (CN)
(73) Assignee: **NINGBO RE-COOK IMP. & EXP. CO., LTD**, Ningbo (CN)

D630,056 S * 1/2011 Rae D7/395
D639,108 S * 6/2011 Molayem D7/356
D658,003 S * 4/2012 Rae D7/395
D678,715 S * 3/2013 Rae D7/395
D713,679 S * 9/2014 Rae A47J 45/08
D7/395
D847,561 S * 5/2019 Wang D7/395
D874,871 S * 2/2020 Barberi D7/395
2009/0084803 A1 * 4/2009 Pasquini A47J 45/08
220/753

(**) Term: **15 Years**
(21) Appl. No.: **29/712,658**
(22) Filed: **Nov. 11, 2019**
(51) **LOC (13) Cl.** **07-02**
(52) **U.S. Cl.**
USPC **D7/395**
(58) **Field of Classification Search**
USPC D7/323, 354, 360, 361, 387, 393–396.2,
D7/402, 509, 514, 533–536, 683, 688,
D7/691; D8/300, 307; D9/431, 434–436,
D9/504, 644–646, 648, 655, 656, 658;
D21/525
CPC A47J 27/00; A47J 36/00; A47J 36/025;
A47J 36/06; A47J 36/08; A47J 45/00;
A47J 45/06061; A47J 45/062; A47J
45/063; A47J 45/065; A47J 45/066; A47J
45/067; A47J 45/07; A47J 45/071; A47J
45/072; A47J 45/074; A47J 45/075; A47J
45/077; A47J 45/078; A47J 45/08
See application file for complete search history.

(56) **References Cited**
U.S. PATENT DOCUMENTS
D512,602 S * 12/2005 Spagnolo D7/395
D561,526 S * 2/2008 Bunting D7/395
D602,307 S * 10/2009 Fort D7/395

OTHER PUBLICATIONS

Design No. 304591707, Nov. 22, 2017—China National Intellectual Property Administration (CNIPA) Publication Date—Apr. 20, 2018
Owner—Ningbo Shama Home Import and Export Ltd, Designer—Wang Jia WIPO, available at <https://www3.wipo.int/designdb/en/index.jsp> (Year: 2018).*

(Continued)

Primary Examiner — Mary Ann Calabrese
Assistant Examiner — Natalya M Rapundalo
(74) *Attorney, Agent, or Firm* — Bayramoglu Law Offices LLC

(57) **CLAIM**

The ornamental design for a cookware handle, as shown and described.

DESCRIPTION

FIG. 1 is a front, right, and bottom perspective view of a cookware handle showing my new design;
FIG. 2 is a front side elevational view thereof;
FIG. 3 is a rear side elevational view thereof;
FIG. 4 is a right side elevational view thereof;
FIG. 5 is a left side elevational view thereof;
FIG. 6 is a bottom plan view thereof; and,
FIG. 7 is a top plan view thereof.

1 Claim, 7 Drawing Sheets

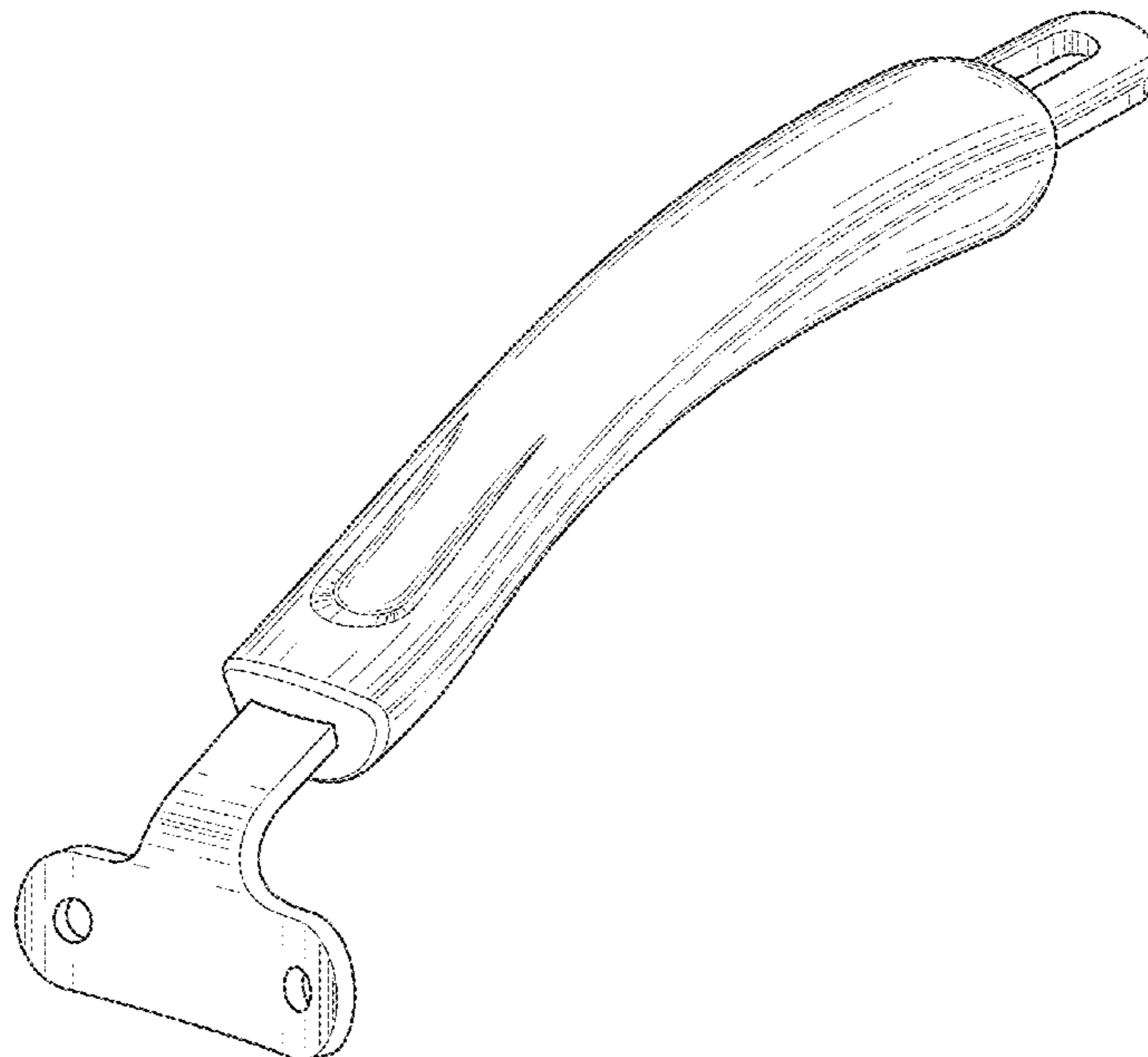

(56)

References Cited

OTHER PUBLICATIONS

Essteel Australis 16cm Saucepan Long Handle, Cookware Brands, [online], [site visited Sep. 30, 2021], Available from internet URL: <https://www.cookwarebrands.com.au/spare-parts/handles/essteel-australis-16cm-saucepan-long-handle.html> (Year: 2021).*

Design No. 306684872, Jan. 4, 2021—China National Intellectual Property Administration (CNIPA) Publication Date—Jul. 16, 2021 Owner —Wuhan Supor Cookware Co Ltd, Designer—Zhang Yani, et. al. WIPO, available at <https://www3.wipo.int/designdb/en/index.jsp> (Year: 2021).*

* cited by examiner

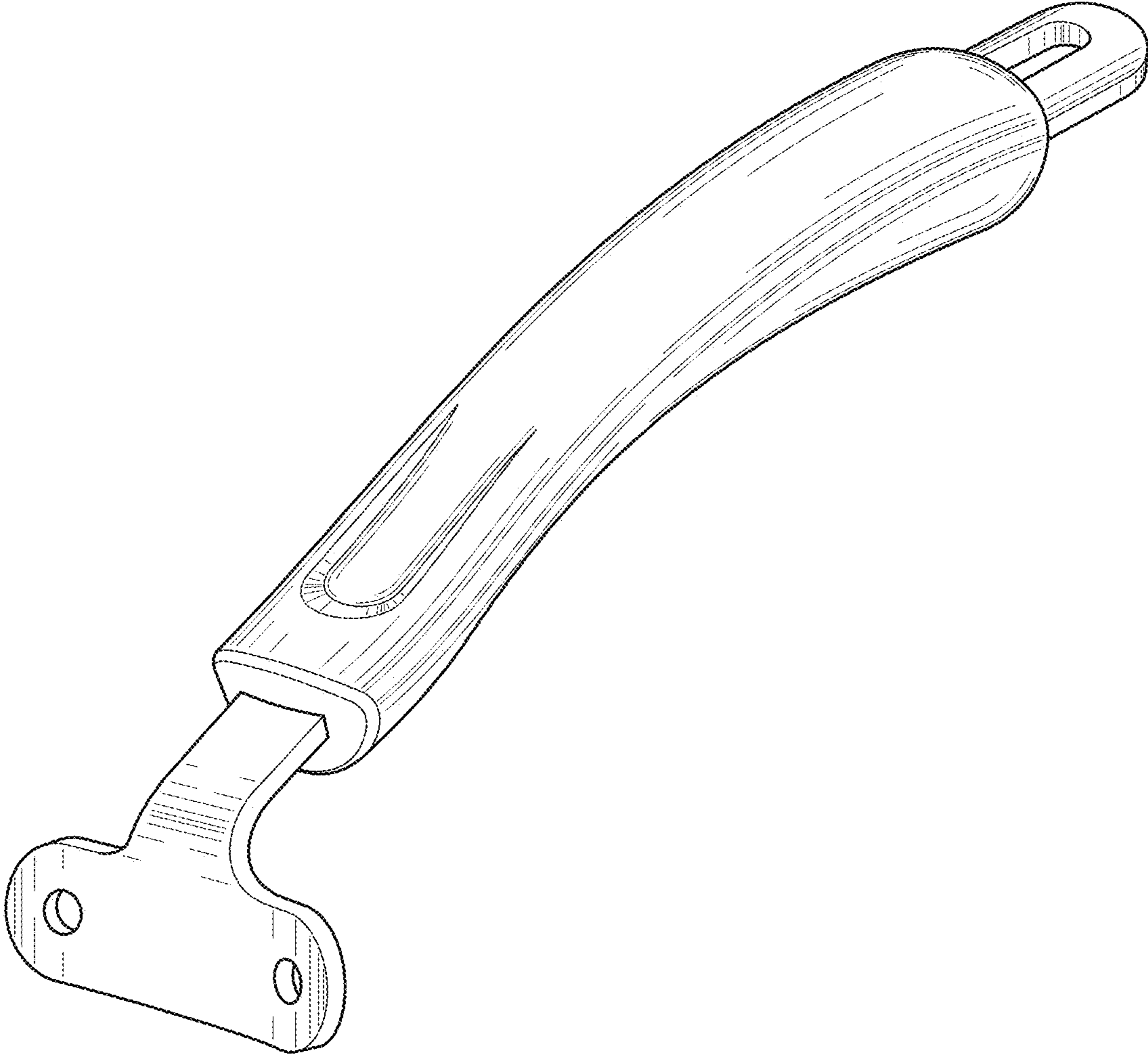

Fig. 1

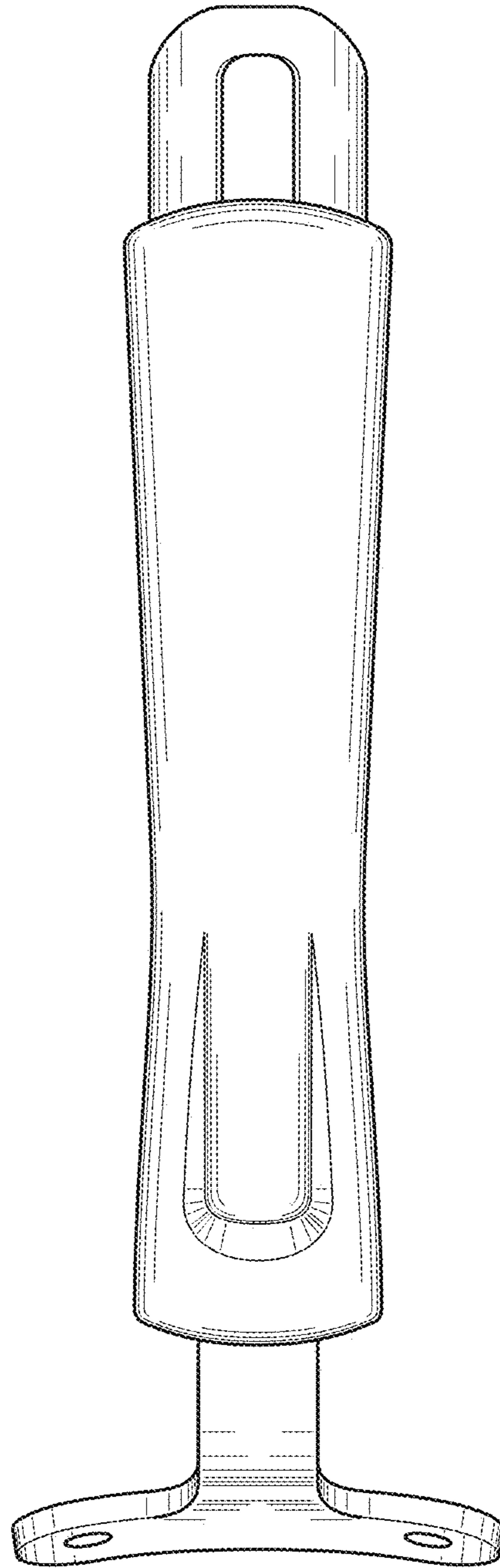

Fig. 2

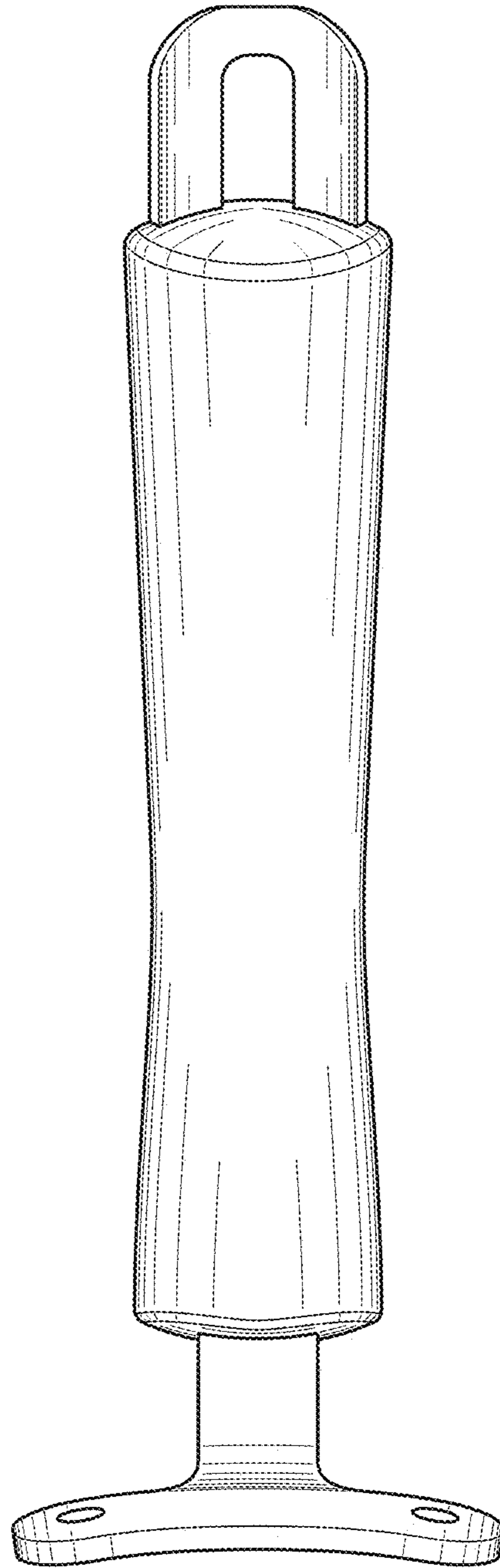

Fig. 3

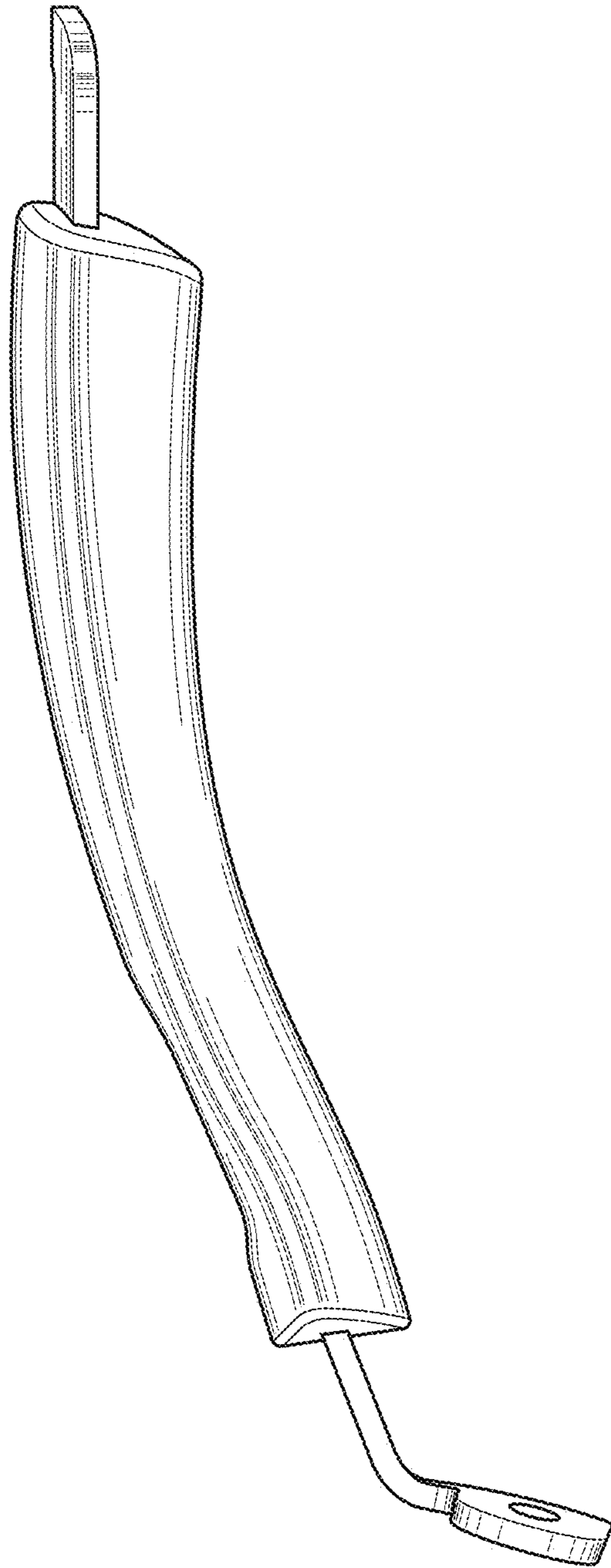

Fig. 4

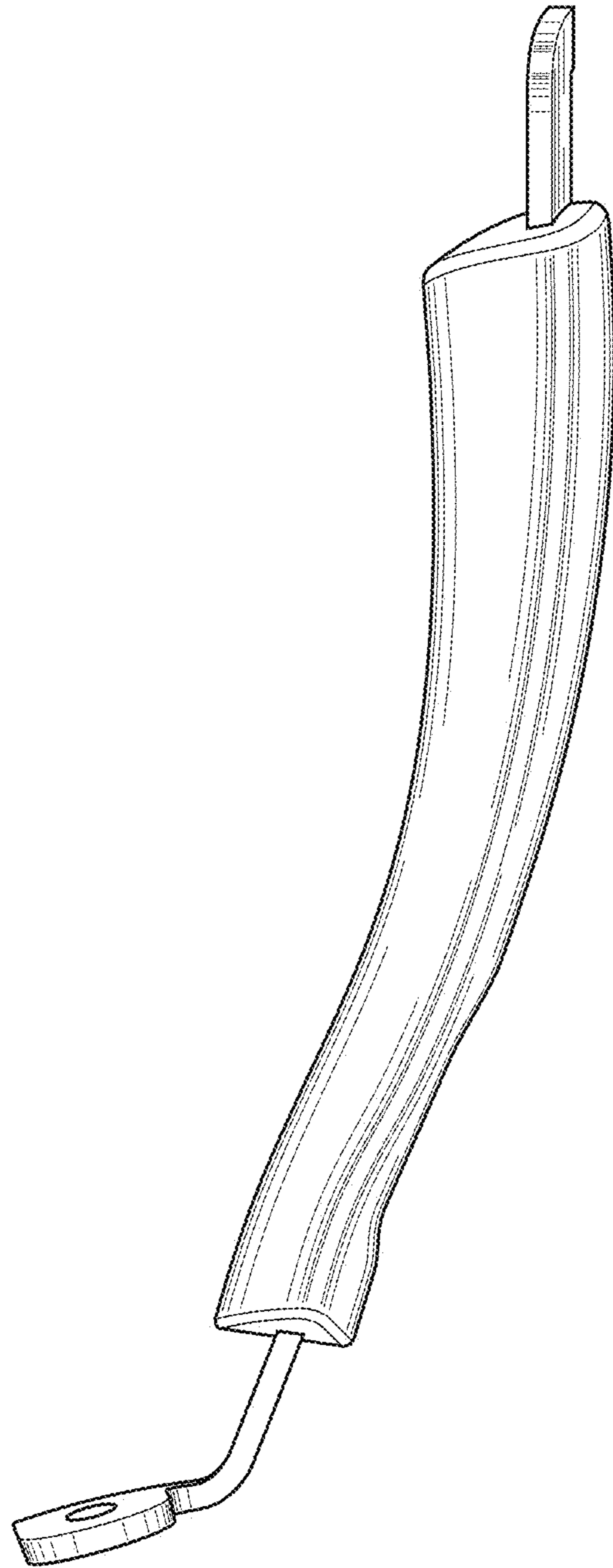

Fig. 5

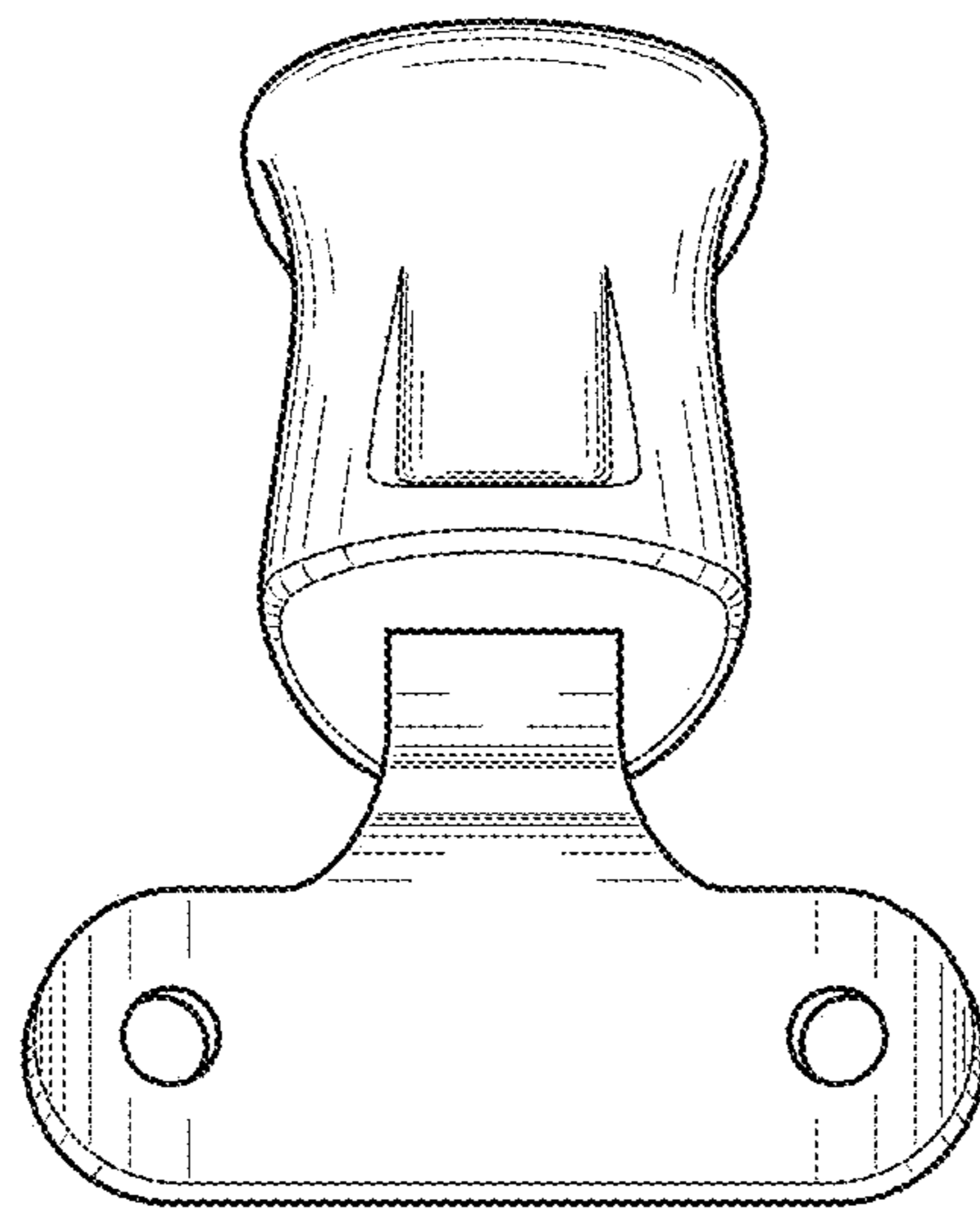

Fig. 6

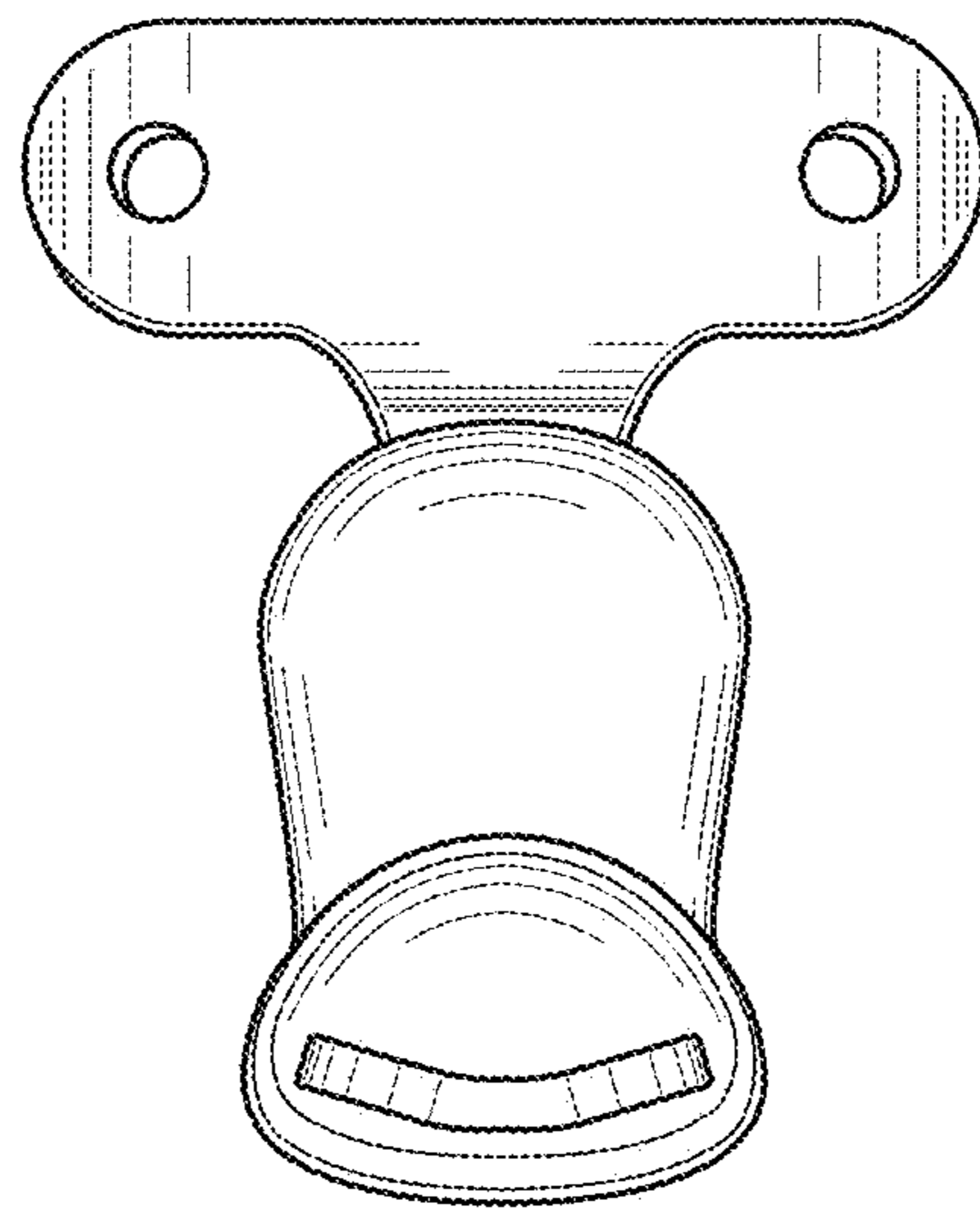

Fig. 7