



US00D938778S

(12) **United States Design Patent** (10) **Patent No.:** **US D938,778 S**
Ge (45) **Date of Patent:** **** Dec. 21, 2021**

(54) **WIDE MOUTH STRAW LID**
(71) Applicant: **Linghuan Ge**, Tongcheng (CN)
(72) Inventor: **Linghuan Ge**, Tongcheng (CN)
(**) Term: **15 Years**
(21) Appl. No.: **29/741,828**
(22) Filed: **Jul. 16, 2020**
(51) **LOC (13) Cl.** **07-99**
(52) **U.S. Cl.**
USPC **D7/392.1; D7/396.2; D9/443; D9/450**
(58) **Field of Classification Search**
USPC D7/624.1, 387, 391, 392, 392.1, 393,
D7/396.1, 400, 378, 396.2-396.4, 401.1,
D7/507, 509-511, 538; D9/686, 723,
D9/724, 414, 434-436, 438-440,
D9/443-457, 499, 503-505, 682, 685;
D24/127, 162; D23/259, 260, 261, 209,
D23/210; D3/202, 203.2, 318; D28/91.1
CPC ... B65D 1/00; B65D 1/02; B65D 1/10; B65D
1/24; B65D 1/46; B65D 2585/56; B65D
2585/545; B65D 41/00; B65D 41/38;
B65D 41/56; B65D 41/62; B65D 47/00;
B65D 47/04; B65D 47/06; B65D 47/08;
B65D 47/20; B65D 23/00; B65D
51/1694; B65D 43/09; B65D 43/16;
B65D 43/0212; B65D 43/265; B65D
43/0208; B65D 43/22; B65D 43/00046;
B65D 43/00092; B65D 43/00222; B65D
2543/00046; B65D 2543/00092; B65D
17/506; B65D 5/46; B65D 2251/00;
B65D 2543/00296; A61J 1/00; A61J
1/1412; A61J 1/02
See application file for complete search history.

(56) **References Cited**
U.S. PATENT DOCUMENTS
D666,874 S 9/2012 Sakulsacha
D717,601 S 11/2014 Dixon
D786,012 S 5/2017 Hein et al.

D804,903 S 12/2017 Mason et al.
D806,468 S * 1/2018 Goodwin D7/392.1
D808,713 S * 1/2018 Rane D7/396.2
D811,162 S * 2/2018 Rane D7/396.2
D855,388 S * 8/2019 Potter D7/392
D868,534 S * 12/2019 Lin D7/392.1
D870,508 S * 12/2019 Palkon D7/392.1
D870,509 S * 12/2019 Bo D7/392.1
D872,522 S * 1/2020 Diener D7/392.1
(Continued)

FOREIGN PATENT DOCUMENTS

CA 184540 * 7/2020

OTHER PUBLICATIONS

Glink Stainless Steel Water Bottle with Straw: Announced Jul. 8, 2020 [online]. Site Visited [Feb. 4, 2020]. Available from Internet URL: https://www.amazon.com/Glink-Stainless-Insulated-Leakproof-Rotating/dp/B089T2KN8B/ref=cm_cr_arp_d_product_top?ie=UTF8.*

(Continued)

Primary Examiner — Wendy L Arminio
(74) *Attorney, Agent, or Firm* — Rumit Ranjit Kanakia

(57) **CLAIM**

I claim the ornamental design for a wide mouth straw lid, as shown and described.

DESCRIPTION

FIG. 1 is a Perspective view of a wide mouth straw lid showing my new design;
FIG. 2 is a Front view thereof;
FIG. 3 is a Back view thereof;
FIG. 4 is a Left-side view thereof;
FIG. 5 is a Right-side view thereof;
FIG. 6 is a Top view thereof; and,
FIG. 7 is a Bottom view thereof.
The broken lines are for the purpose of illustrating portions of the article that form no part of the claim.

1 Claim, 7 Drawing Sheets

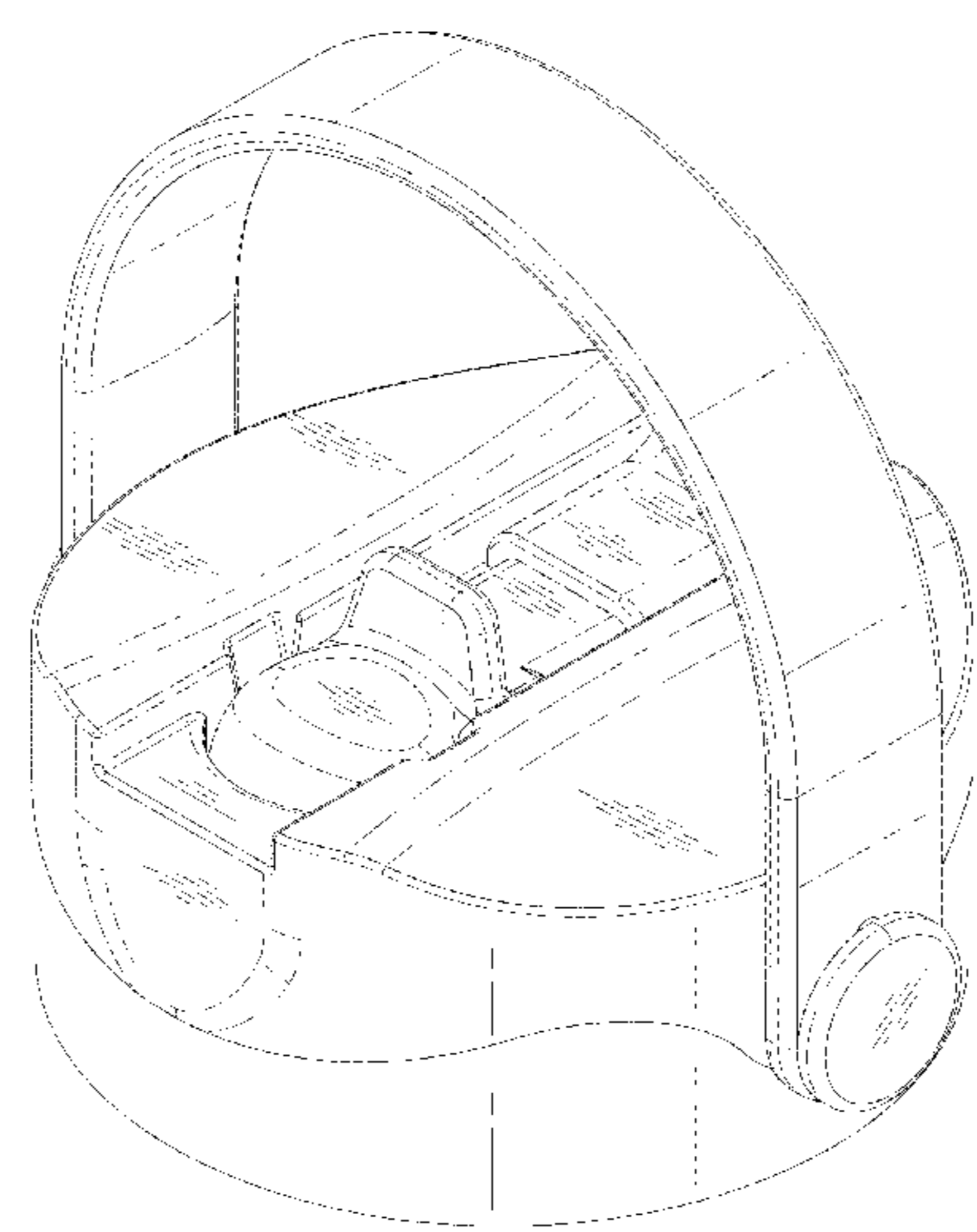

(56)

References Cited

U.S. PATENT DOCUMENTS

D872,524 S * 1/2020 Bo D7/392.1
 D885,823 S * 6/2020 Ayres D7/392.1
 D886,517 S 6/2020 Bo
 D887,776 S * 6/2020 Bo D7/392.1
 D893,245 S * 8/2020 Zhang D7/392.1
 D894,671 S * 9/2020 Huang D7/392.1
 D894,672 S * 9/2020 Huang D7/392.1
 D896,574 S * 9/2020 Wang D7/392.1
 D897,146 S * 9/2020 Lane D7/392.1
 D897,761 S * 10/2020 Zhang D7/392.1
 D899,848 S * 10/2020 Zhang D7/392.1
 D899,849 S * 10/2020 Zhang D7/392.1
 D900,537 S * 11/2020 Yao D7/392.1
 D900,538 S * 11/2020 Yao D7/392.1
 D900,539 S * 11/2020 Yao D7/392.1
 D903,403 S * 12/2020 Ames D7/392.1
 D903,405 S * 12/2020 Zhang D7/392.1
 D904,109 S * 12/2020 Yao D7/392.1

D905,499 S * 12/2020 Zhang D7/392.1
 D906,042 S * 12/2020 Chen D7/392.1
 2015/0173539 A1* 6/2015 Mason B65D 47/063
 220/707
 2020/0095031 A1* 3/2020 Cheng B65D 47/066

OTHER PUBLICATIONS

Pivot Straw Cap: Announced Sep. 21, 2020 [online]. Site Visited [Feb. 3, 2021]. Available from Internet URL: <https://www.lifefactory.com/pivot-straw-cap-for-12-16-22oz-bottles>.
 Wide Mouth Straw Lid: Site Visited [Feb. 3, 2021], Available from Internet URL: https://www.alibaba.com/product-detail/Wide-Mouth-Straw-Lid-BPA-Free_62253864125.html?spm=a2700.7724857.0.0.491d38e0mZgv8S.
 Wide Mouth Water Bottle: Site Visited [Feb. 3, 2021]. Available from Internet URL: https://www.alibaba.com/product-detail/Wide-Mouth-Water-Bottle-Cap-Sports_62185490530.html?spm=a2700.7724857.normal_offer.d_title.79fd38e0%E2%80%A6.

* cited by examiner

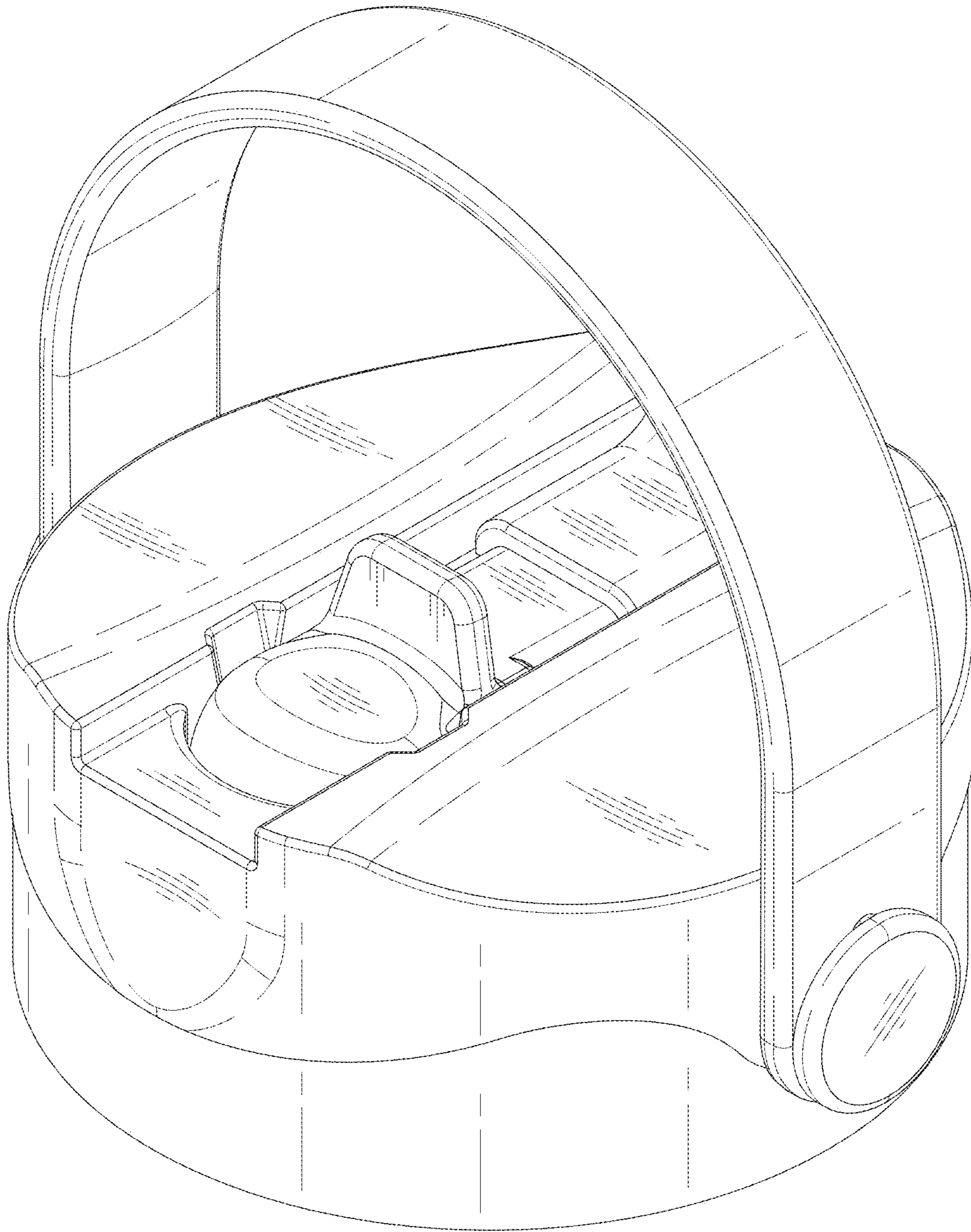

FIG. 1

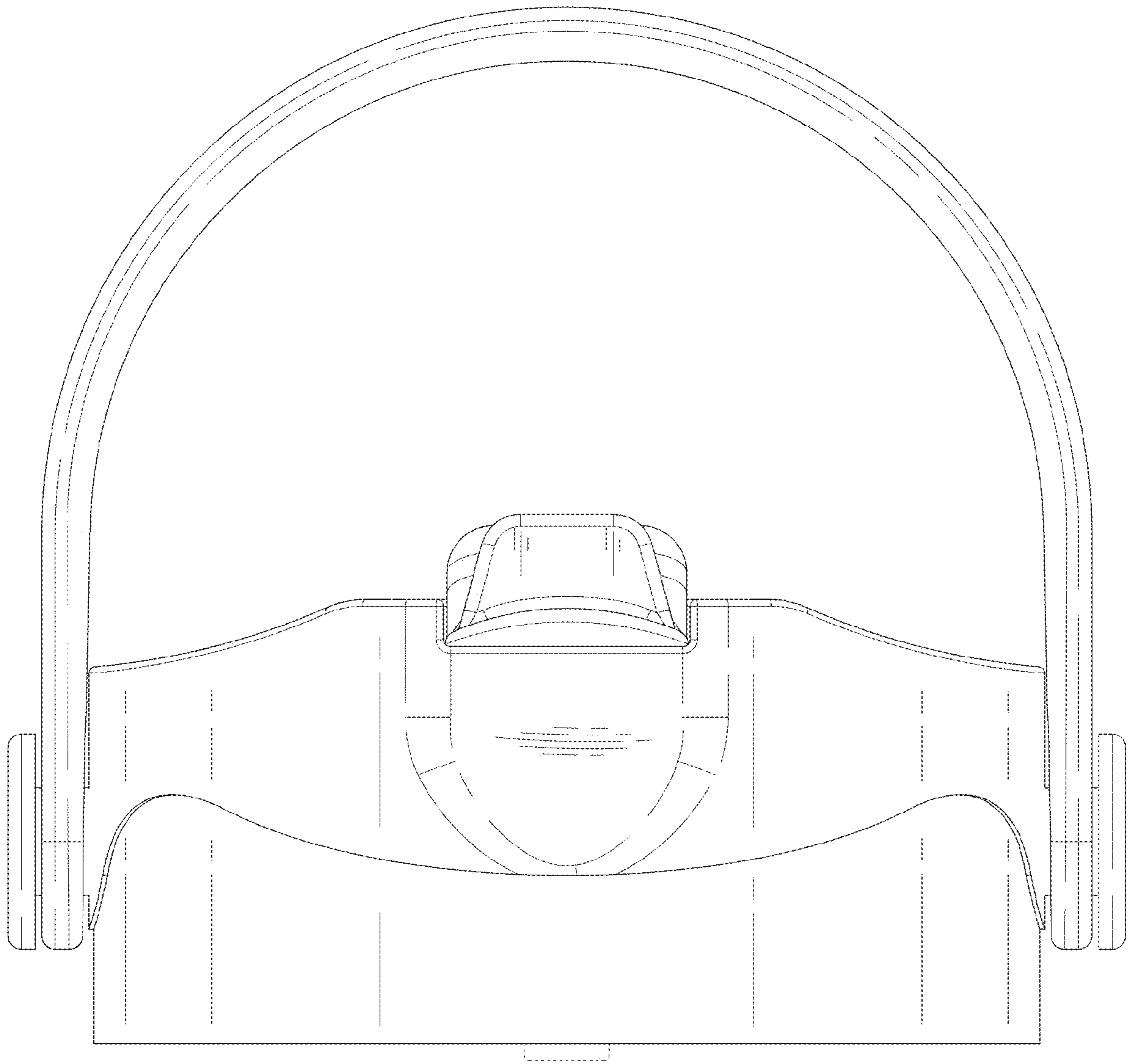

FIG. 2

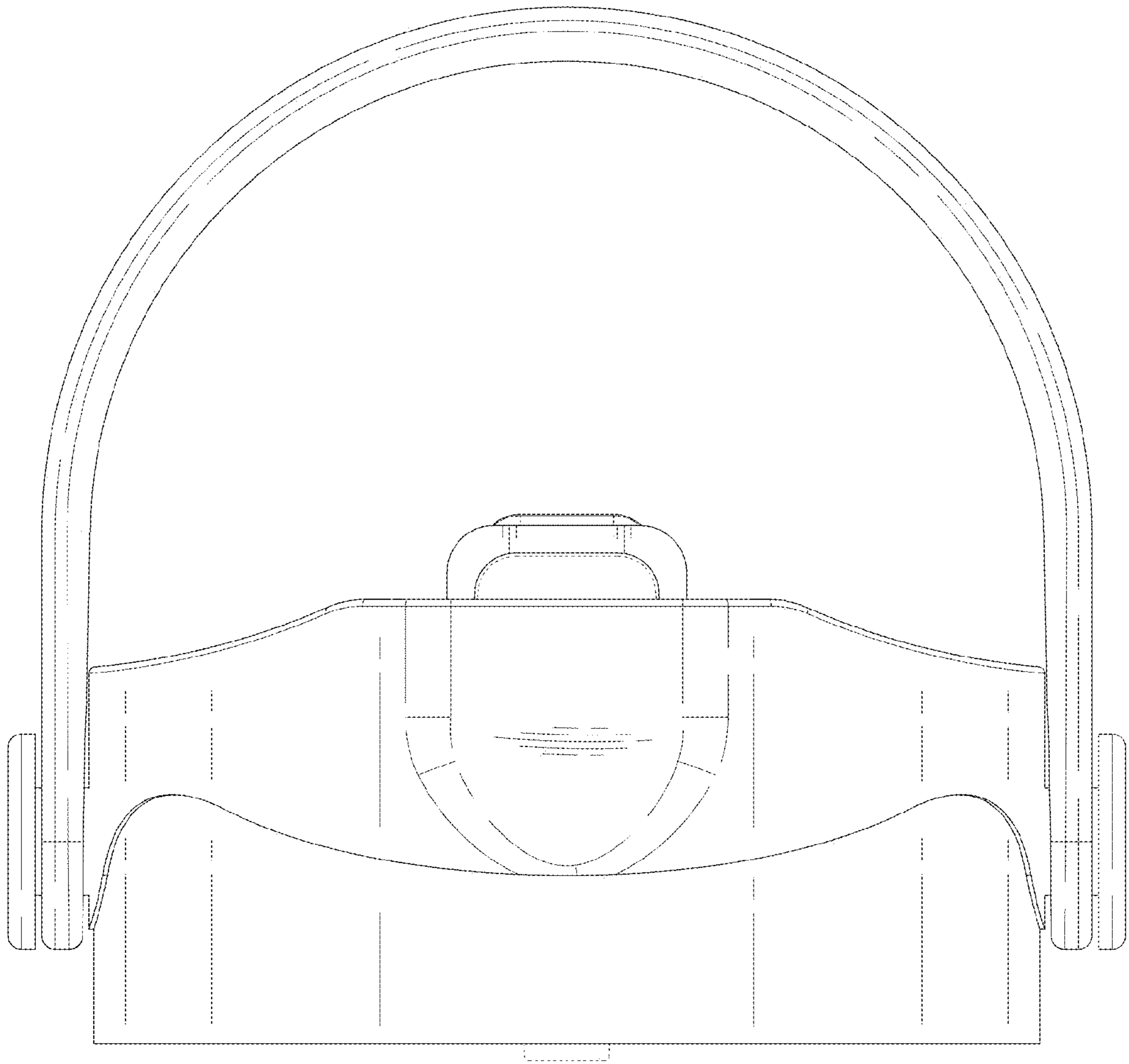

FIG. 3

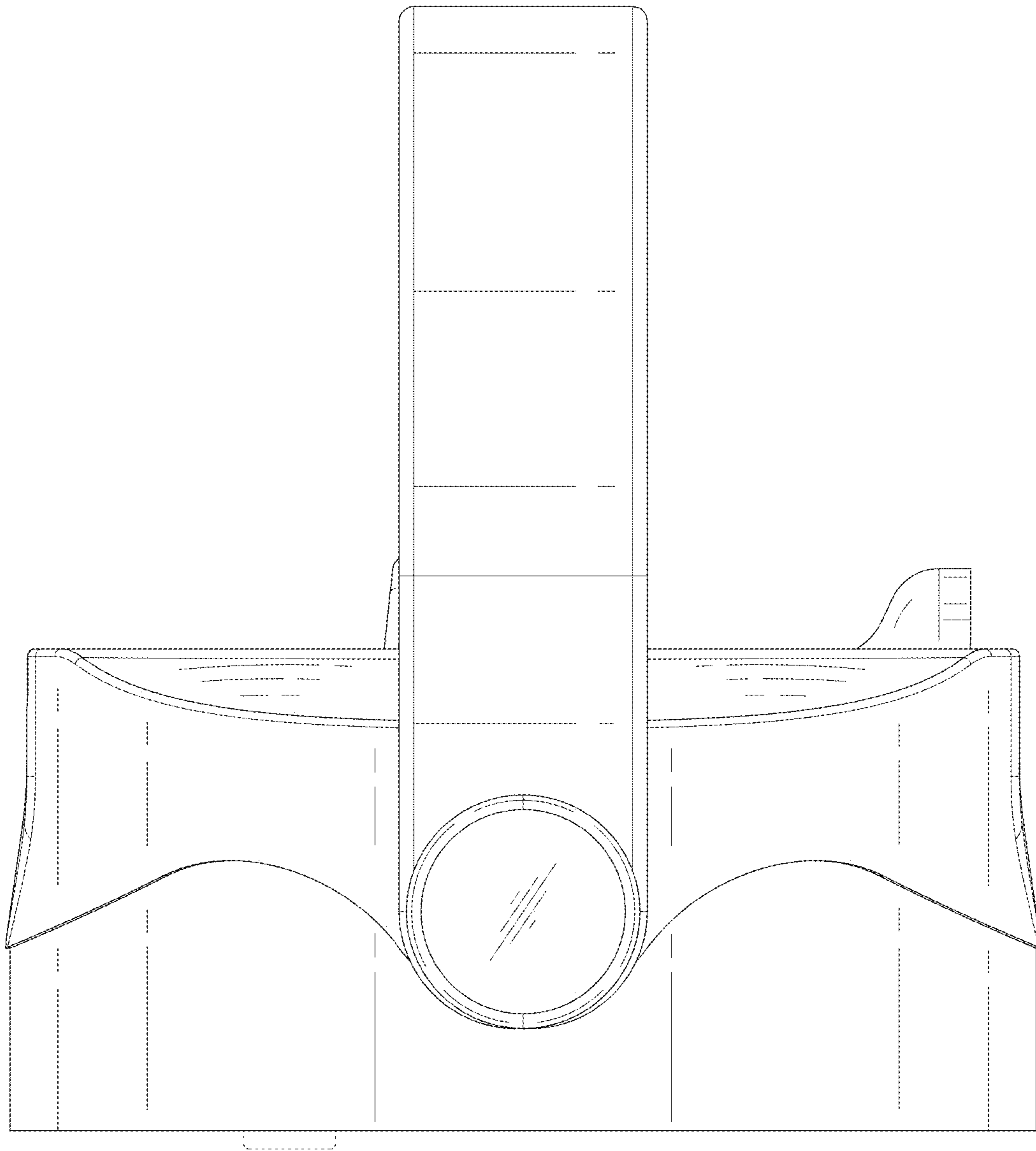

FIG. 4

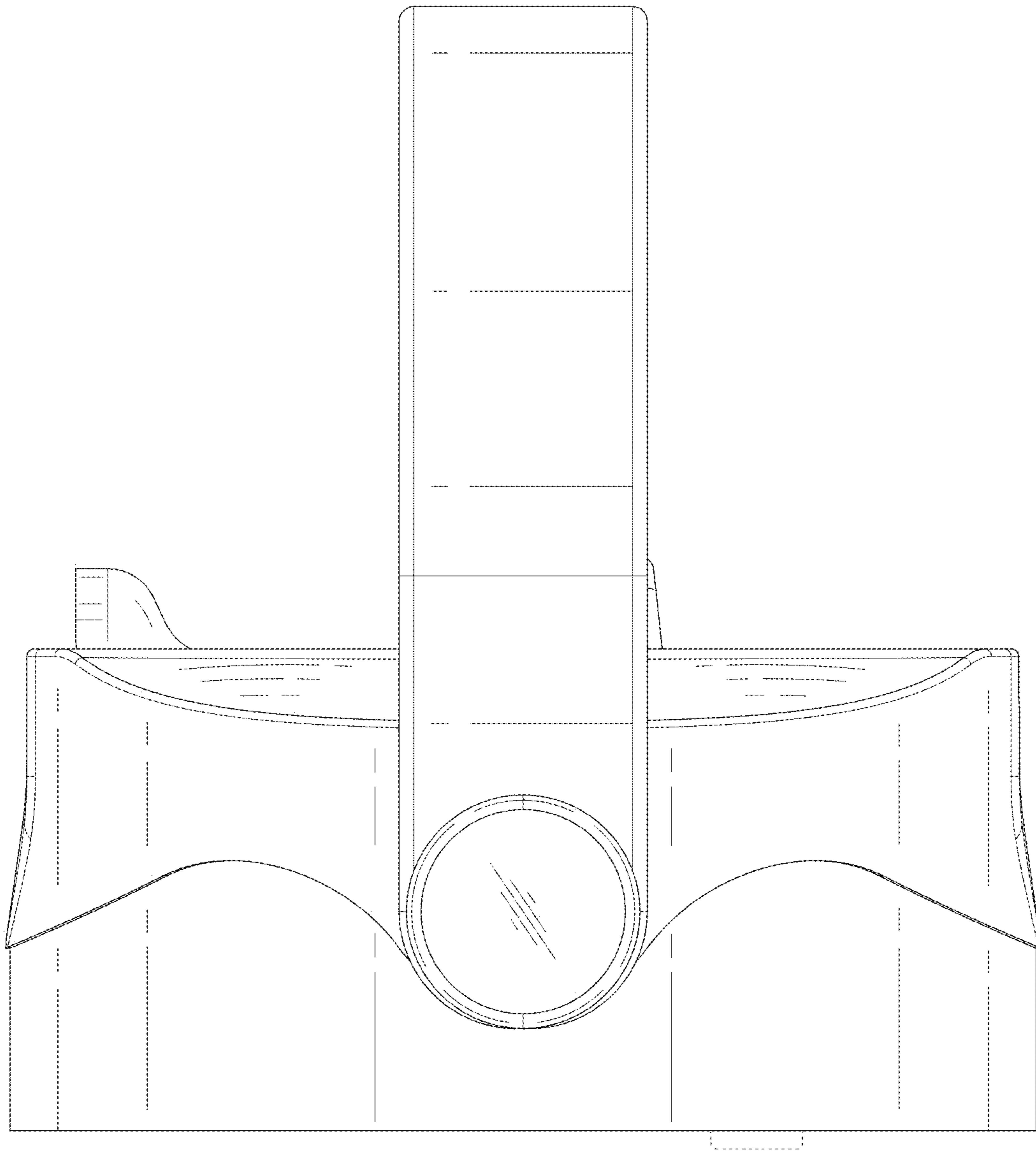

FIG. 5

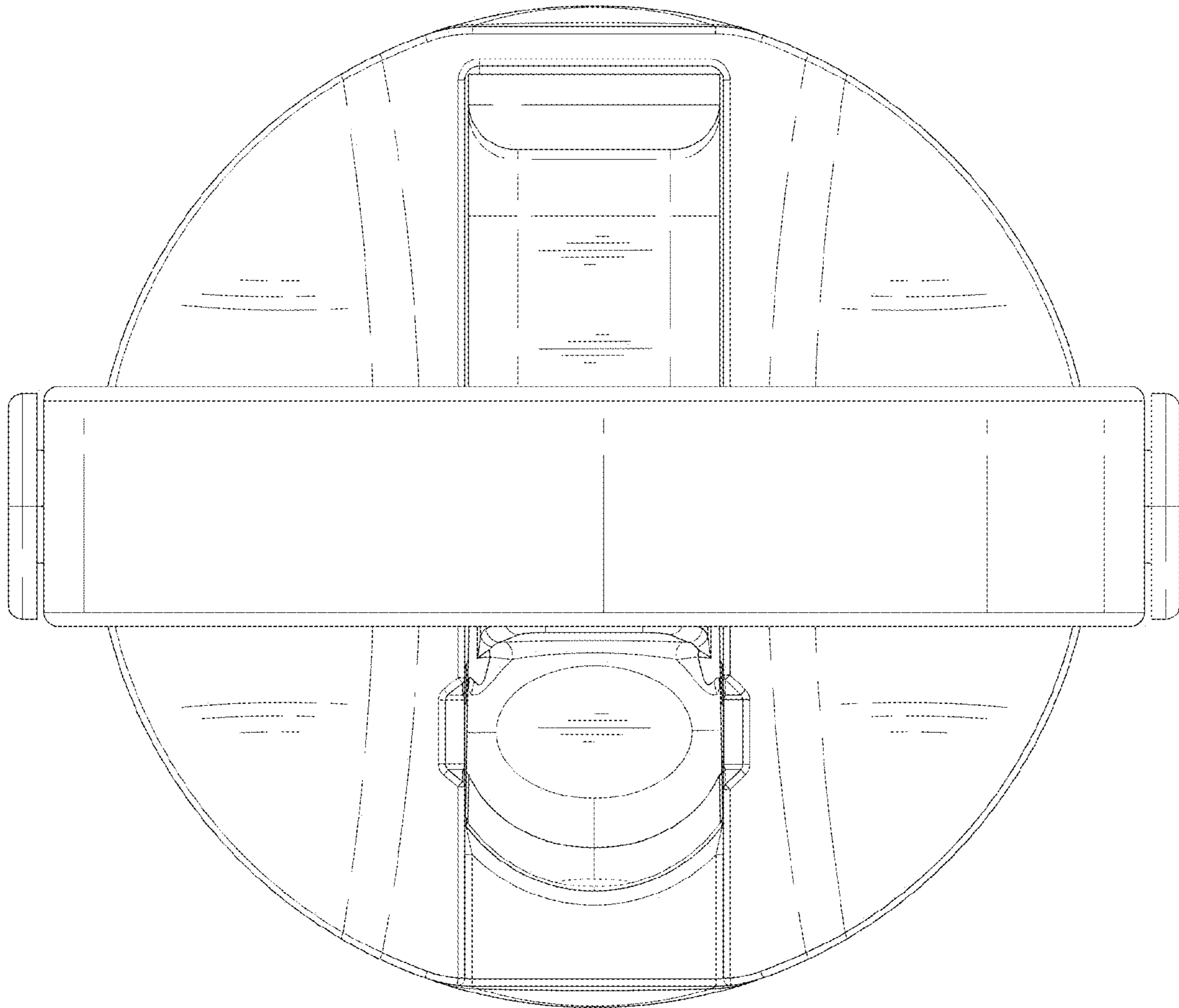

FIG. 6

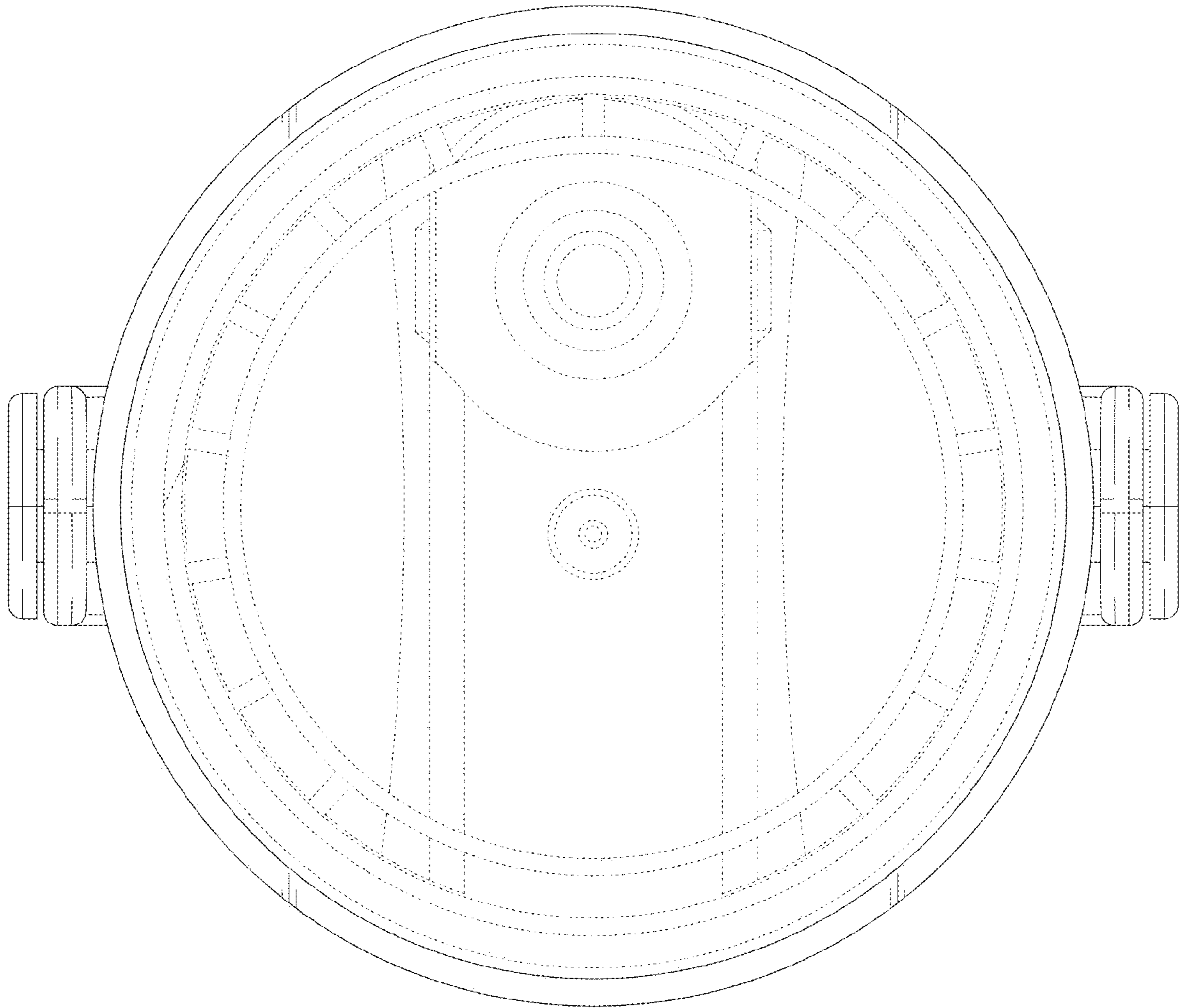

FIG. 7