



US00D938650S

(12) **United States Design Patent**  
**Durham**

(10) **Patent No.:** **US D938,650 S**

(45) **Date of Patent:** **\*\* \*Dec. 14, 2021**

(54) **HAIR ELASTIC**

(71) Applicant: **Durham Enterprises Corporation,**  
Salt Lake City, UT (US)

(72) Inventor: **Jeffery S. Durham,** Kaysville, UT (US)

(\* ) Notice: This patent is subject to a terminal disclaimer.

(\*\*) Term: **15 Years**

(21) Appl. No.: **29/730,035**

(22) Filed: **Mar. 31, 2020**

**Related U.S. Application Data**

(63) Continuation-in-part of application No. 29/670,091, filed on Nov. 13, 2018, now abandoned.

(51) **LOC (13) Cl.** ..... **28-03**

(52) **U.S. Cl.**  
USPC ..... **D28/41**

(58) **Field of Classification Search**  
USPC ..... D28/10, 21, 25, 27, 32, 33, 34, 35, 39,  
D28/40, 41, 42, 43

CPC ..... A45D 6/045; A45D 8/00; A45D 8/002;  
A45D 8/004; A45D 8/006; A45D 8/008;  
A45D 8/02; A45D 8/06; A45D 8/08;  
A45D 8/10; A45D 8/12; A45D 8/14;  
A45D 8/16; A45D 8/18; A45D 8/20;  
A45D 8/22; A45D 8/24; A45D 8/26;  
A45D 8/28; A45D 8/30; A45D 8/32

See application file for complete search history.

(56) **References Cited**

**U.S. PATENT DOCUMENTS**

X536965 4/1895 Neuberger  
536,965 A \* 4/1895 Neuberger ..... F16B 15/0046  
403/283

2,343,408 A 3/1944 Glass  
5,305,470 A \* 4/1994 McKay ..... A41D 20/005  
2/170  
6,047,708 A 4/2000 Panel et al.  
6,227,011 B1 5/2001 Cortinovis  
D450,886 S 11/2001 Sapp  
6,516,853 B1 2/2003 Gabrielsen et al.  
D666,770 S 9/2012 Hsu  
9,055,800 B2 \* 6/2015 Harvie ..... G09B 19/0076  
9,173,467 B2 \* 11/2015 Passarello ..... A45D 8/36  
D789,237 S 6/2017 Chung  
9,775,413 B1 10/2017 Ingimundarson et al.  
D812,300 S 3/2018 Conway

(Continued)

**OTHER PUBLICATIONS**

Gimme Bands—Like No Other Hair Band, announced Oct. 22, 2018 [online], retrieved Sep. 9, 2020, retrieved from internet, <https://www.youtube.com/watch?v=RVSSLX74rT0>.\*

(Continued)

*Primary Examiner* — Dana K Weiland

*Assistant Examiner* — Messina L Smith

(74) *Attorney, Agent, or Firm* — Dentons Durham Jones Pinegar

(57)

**CLAIM**

The ornamental design for a hair elastic, as shown and described.

**DESCRIPTION**

FIG. 1 is a perspective view of a hair elastic showing my new design;

FIG. 2 is a top view of the hair elastic;

FIG. 3 is a bottom view of the hair elastic;

FIG. 4 is a front elevational view of the hair elastic;

FIG. 5 is a rear elevational view of the hair elastic;

FIG. 6 is a first side elevational view of the hair elastic; and,

FIG. 7 is a second side elevational view of the hair elastic.

**1 Claim, 1 Drawing Sheet**

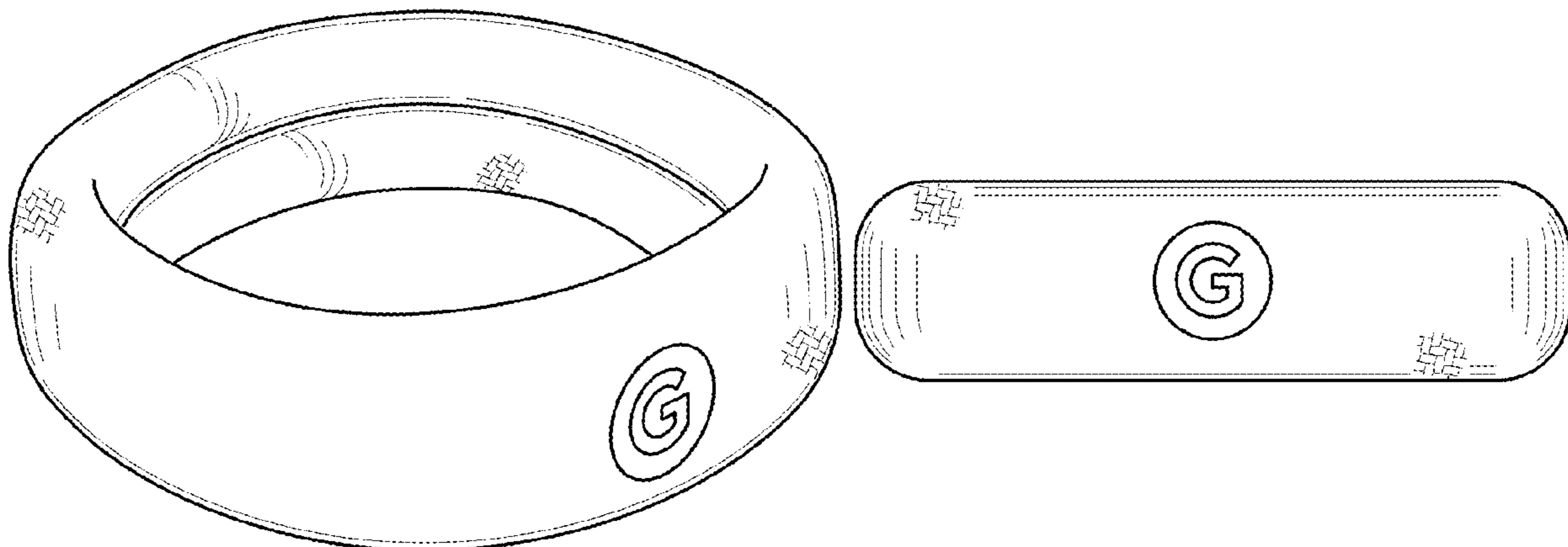

(56)

References Cited

U.S. PATENT DOCUMENTS

D859,742	S	9/2019	Harrel	
10,709,222	B2 *	7/2020	Harvie .....	A45D 8/36
D893,802	S *	8/2020	Luo .....	D28/41
10,897,974	B2	1/2021	Passarello	
10,939,737	B2	3/2021	Nicholas et al.	
2007/0094768	A1 *	5/2007	Moudgill .....	A45D 8/36 2/171
2011/0253159	A1	10/2011	Stachowski	
2014/0250566	A1 *	9/2014	Stegerhoek .....	A45D 8/36 2/209.3
2014/0318180	A1 *	10/2014	Cabe .....	A44C 15/003 63/5.1
2015/0335124	A1	11/2015	Passarello	
2020/0138162	A1 *	5/2020	Sze .....	A45D 8/34
2020/0146416	A1 *	5/2020	Durham .....	A45D 8/34
2020/0196690	A1 *	6/2020	Sohn .....	A44C 15/006
2020/0196730	A1 *	6/2020	Abualhaija .....	A45D 8/36

OTHER PUBLICATIONS

Tiny Expressions, announced Mar. 21, 2018 [online], retrieved Sep. 9, 2020, retrieved from internet, [https://www.amazon.com/Tiny-Expressions-Embroidered-Baseball-Monogrammed/dp/B07BN3W72J/ref=sr\\_1\\_43?dchild=1&keywords=%22G%22%2BHAT&qid=1599674097&sr=8-43&th=1.\\*](https://www.amazon.com/Tiny-Expressions-Embroidered-Baseball-Monogrammed/dp/B07BN3W72J/ref=sr_1_43?dchild=1&keywords=%22G%22%2BHAT&qid=1599674097&sr=8-43&th=1.*)

Elastic Hair Ties J-MEE 30 Count Thick Hair No Slip Damage Glitter Hair accessories Rubber bands, announced Dec. 17, 2016 [online], retrieved Sep. 9, 2020, retrieved from internet, [https://www.amazon.com/gp/product/B01N3YX8L9/?tag=hairaccessories-20&pbpc=160417063032.\\*](https://www.amazon.com/gp/product/B01N3YX8L9/?tag=hairaccessories-20&pbpc=160417063032.*)

Frcolor 190 Pieces Hair Elastics Hair Ties Hair Bands Bulk Ponytail Holders, announced Oct. 25, 2017 [online], retrieved Sep. 9, 2020, retrieved from internet, [https://www.amazon.com/dp/B071R7LP8G/ref=sspa\\_dk\\_detail\\_2?psc=1&pd\\_rd\\_i=B071R7LP8G&pd\\_rd\\_w=9UhqU&pf\\_rd\\_p=45a72588-80f7-4414-9851-786f6c16d42b&pd\\_rd\\_w.\\*](https://www.amazon.com/dp/B071R7LP8G/ref=sspa_dk_detail_2?psc=1&pd_rd_i=B071R7LP8G&pd_rd_w=9UhqU&pf_rd_p=45a72588-80f7-4414-9851-786f6c16d42b&pd_rd_w.*)

Gimme Bands—Starter Kit, announced Aug. 2, 2019 [online], retrieved Sep. 9, 2020, retrieved from internet, [https://gimmebeauty.com/products/gimme-bands-starter-kit.\\*](https://gimmebeauty.com/products/gimme-bands-starter-kit.*)

Gimme Bands No Break Thick Hair Ties, announced Jan. 9, 2019 [online], retrieved Sep. 9, 2020, retrieved from internet, [https://www.amazon.com/GIMME-Bands-Break-Thick-Chestnut/dp/B07KXBSSWS?th=1.\\*](https://www.amazon.com/GIMME-Bands-Break-Thick-Chestnut/dp/B07KXBSSWS?th=1.*)

Elastic Hair Ties J-MEE 30 Count, announced Dec. 17, 2016 [online], retrieved Dec. 23, 2019, retrieved from internet, <https://www.amazon.com/gp/product/B01N3YX8L9/?tag=hairaccessories-20&pbpc=160417063032>.

Frcolor 190 Pieces Hair Elastics, announced Oct. 25, 2017 [online], retrieved Dec. 23, 2019, retrieved from internet, [https://www.amazon.com/dp/B071R7LP8G/ref=sspa\\_dk\\_detail\\_2?psc=1&pd\\_rd\\_i=B071R7LP8G&pd\\_rd\\_w=9UhqU&pf\\_rd\\_p=45a72588-80f7-4414-9851-786f6c16d42b&pd\\_rd\\_wg=1VGhM&pf\\_rd\\_r=2BB95F76ZE86H2ZTKNJ5&pd\\_rd\\_](https://www.amazon.com/dp/B071R7LP8G/ref=sspa_dk_detail_2?psc=1&pd_rd_i=B071R7LP8G&pd_rd_w=9UhqU&pf_rd_p=45a72588-80f7-4414-9851-786f6c16d42b&pd_rd_wg=1VGhM&pf_rd_r=2BB95F76ZE86H2ZTKNJ5&pd_rd_)

\* cited by examiner

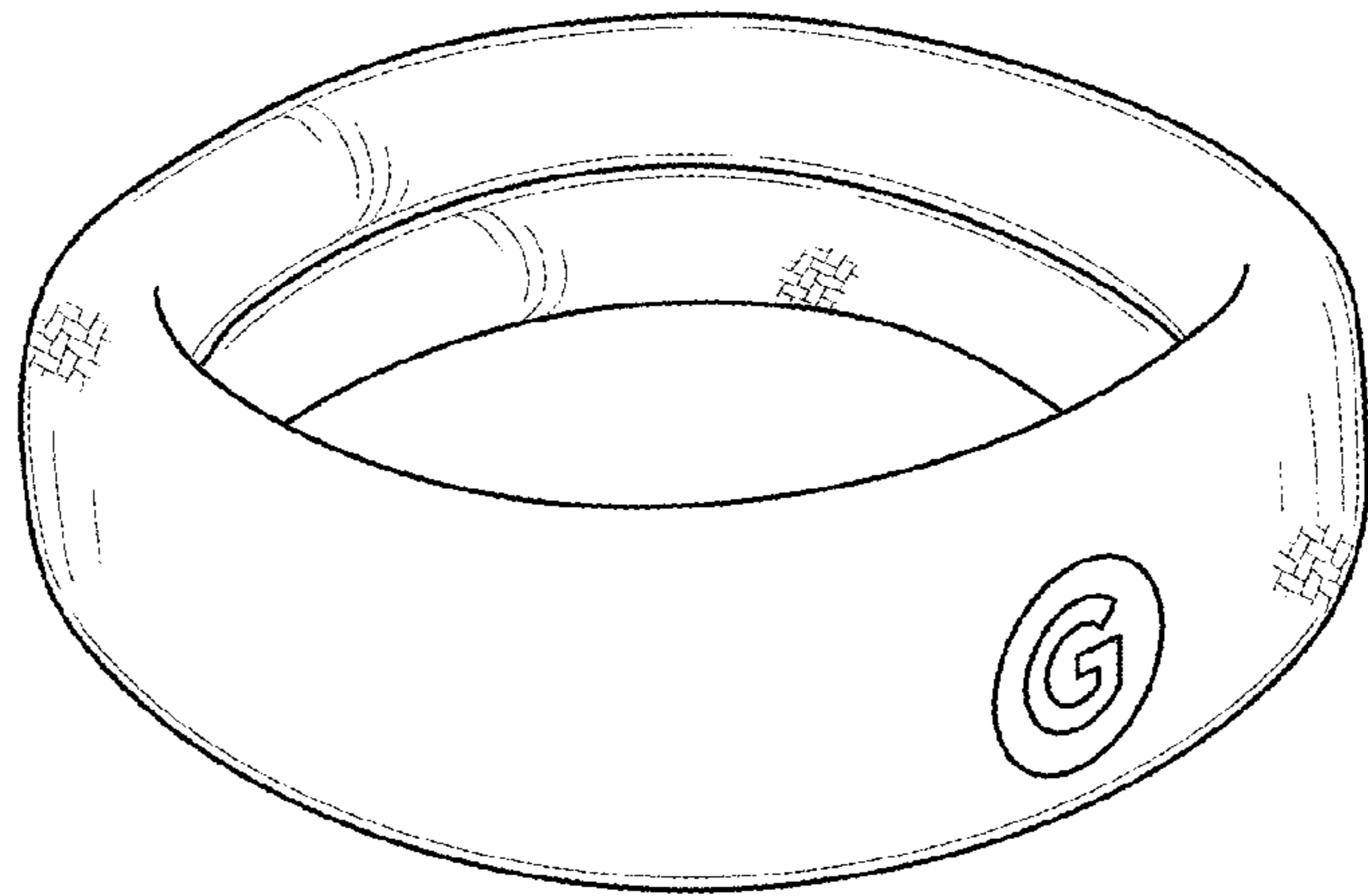

**FIG. 1**

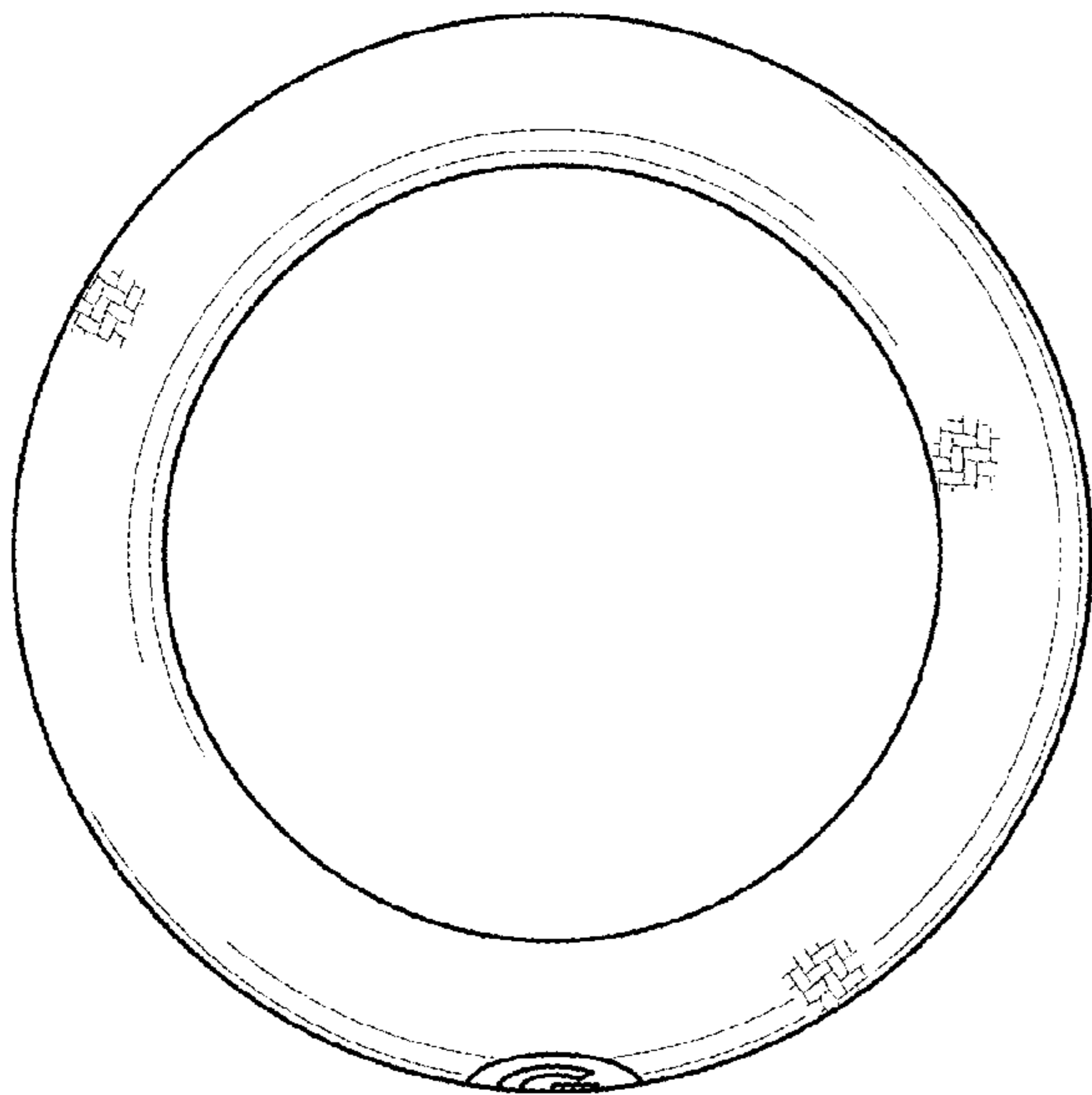

**FIG. 2**

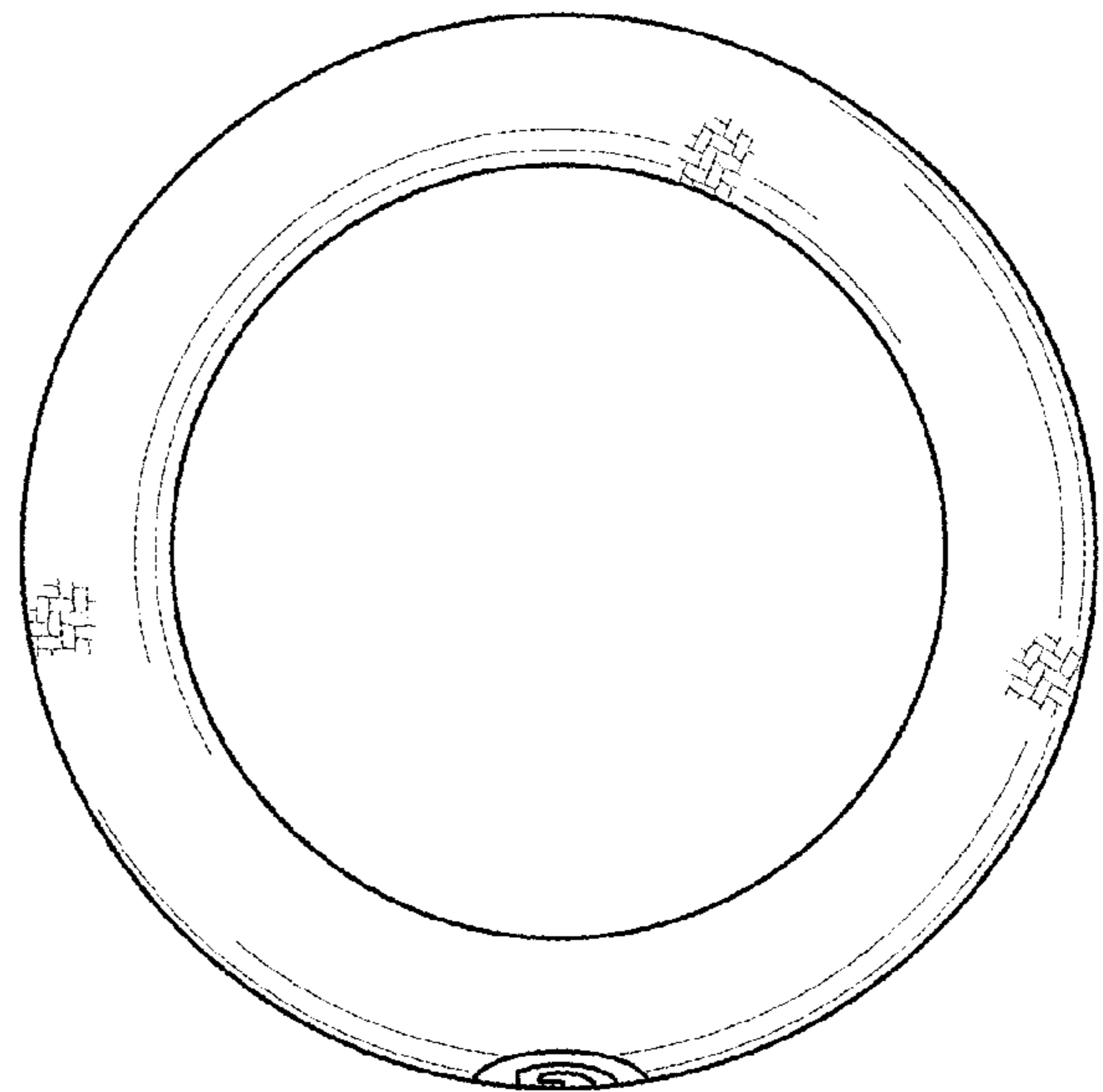

**FIG. 3**



**FIG. 4**

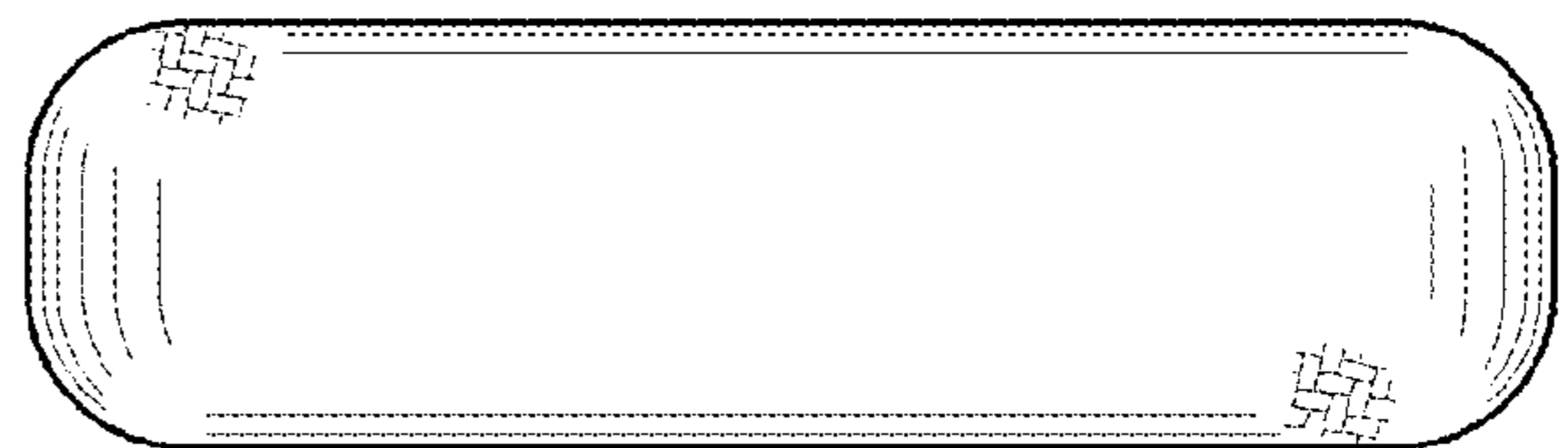

**FIG. 5**

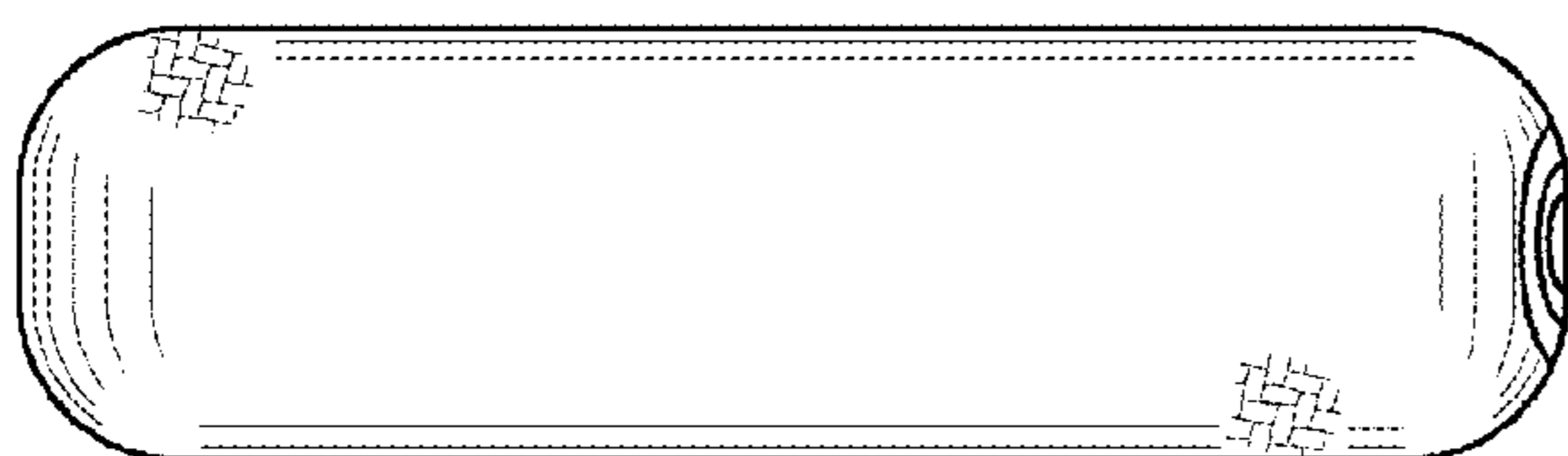

**FIG. 6**

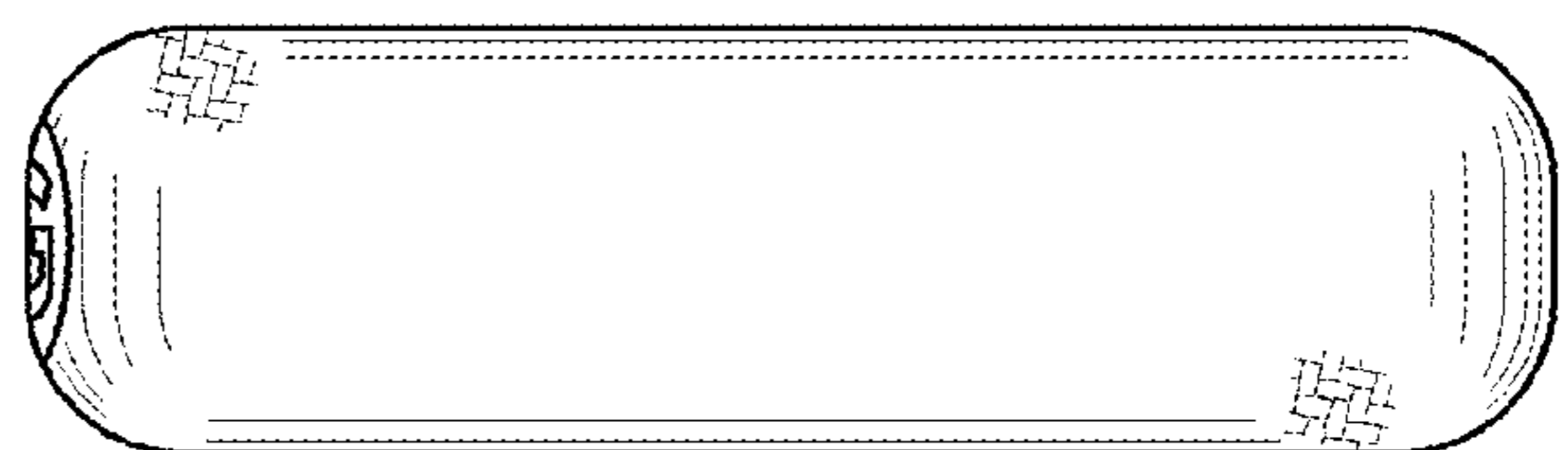

**FIG. 7**