



US00D938558S

(12) **United States Design Patent** (10) **Patent No.:** **US D938,558 S**
Flaig et al. (45) **Date of Patent:** **** Dec. 14, 2021**

(54) **SINK AND MIRROR ASSEMBLY**

FOREIGN PATENT DOCUMENTS

(71) Applicant: **Hansgrohe SE**, Schiltach (DE)
(72) Inventors: **Marco Flaig**, Stuttgart (DE); **Matthias Oesterle**, Winterbach (DE)

CN 302434011 5/2013
CN 304390352 12/2017

(Continued)

(73) Assignee: **Hansgrohe SE**, Schiltach (DE)

OTHER PUBLICATIONS

(**) Term: **15 Years**

DIY Sunrise Mirror [online], [site visited Jul. 29, 2020]. Available from internet, URL:<<https://www.woodshopdiaries.com/diy-sunrise-mirror-a-project-born-from-laziness/>> (Year: 2016).*

(21) Appl. No.: **29/704,450**

(Continued)

(22) Filed: **Sep. 5, 2019**

Primary Examiner — Cynthia Ramirez

Assistant Examiner — Xavier Marti-Santos

(30) **Foreign Application Priority Data**

(74) *Attorney, Agent, or Firm* — Lora J. Graentzdoerffer

Mar. 8, 2019 (EM) 006293734-0017

(51) **LOC (13) Cl.** **23-02**

(57) **CLAIM**

(52) **U.S. Cl.**

The ornamental design for a sink and mirror assembly, as shown and described.

USPC **D23/284**

(58) **Field of Classification Search**

DESCRIPTION

USPC D6/300, 301, 302, 303, 304, 307, 308,
D6/309, 310, 311, 312, 313, 314, 444,
D6/642, 633, 664.1, 671, 671.3, 655;
D23/284, 286, 287, 272-274, 303, 308;
D26/56; D19/1, 4, 5, 6; D5/9, 10, 63,
D5/64

FIG. 1 is a perspective view of a sink and mirror assembly showing our design;
FIG. 2 is a front elevation view;
FIG. 3 is a rear elevation view;
FIG. 4 is a right side elevation view;
FIG. 5 is a left side elevation view;
FIG. 6 is a top plan view;
FIG. 7 is a bottom plan view;
FIG. 8 is an enlarged detail section view of FIG. 1; and,
FIG. 9 is an enlarged detail section view of FIG. 2.

CPC E03C 2201/90; E03C 1/33; E03C 1/18;
E03C 1/32; A47B 2220/03; A47B 77/06;
A47B 67/005; A47B 67/02; A47G 1/16;
A47G 1/00; A47G 1/02; A47G 1/0616

See application file for complete search history.

The broken-line disclosures in the views represent portions of the sink and mirror assembly in which the claimed design is embodied, which form no part of the claimed design. The additional broken lines are demarcating the enlarged areas and form no part of the claimed design.

(56) **References Cited**

1 Claim, 9 Drawing Sheets

U.S. PATENT DOCUMENTS

D430,274 S * 8/2000 Marshall D23/284
D483,574 S * 12/2003 Wanek D6/309
D486,895 S * 2/2004 Brooks D23/308
D488,626 S * 4/2004 Kruger D6/309
D521,130 S * 5/2006 Mayer D23/293.1

(Continued)

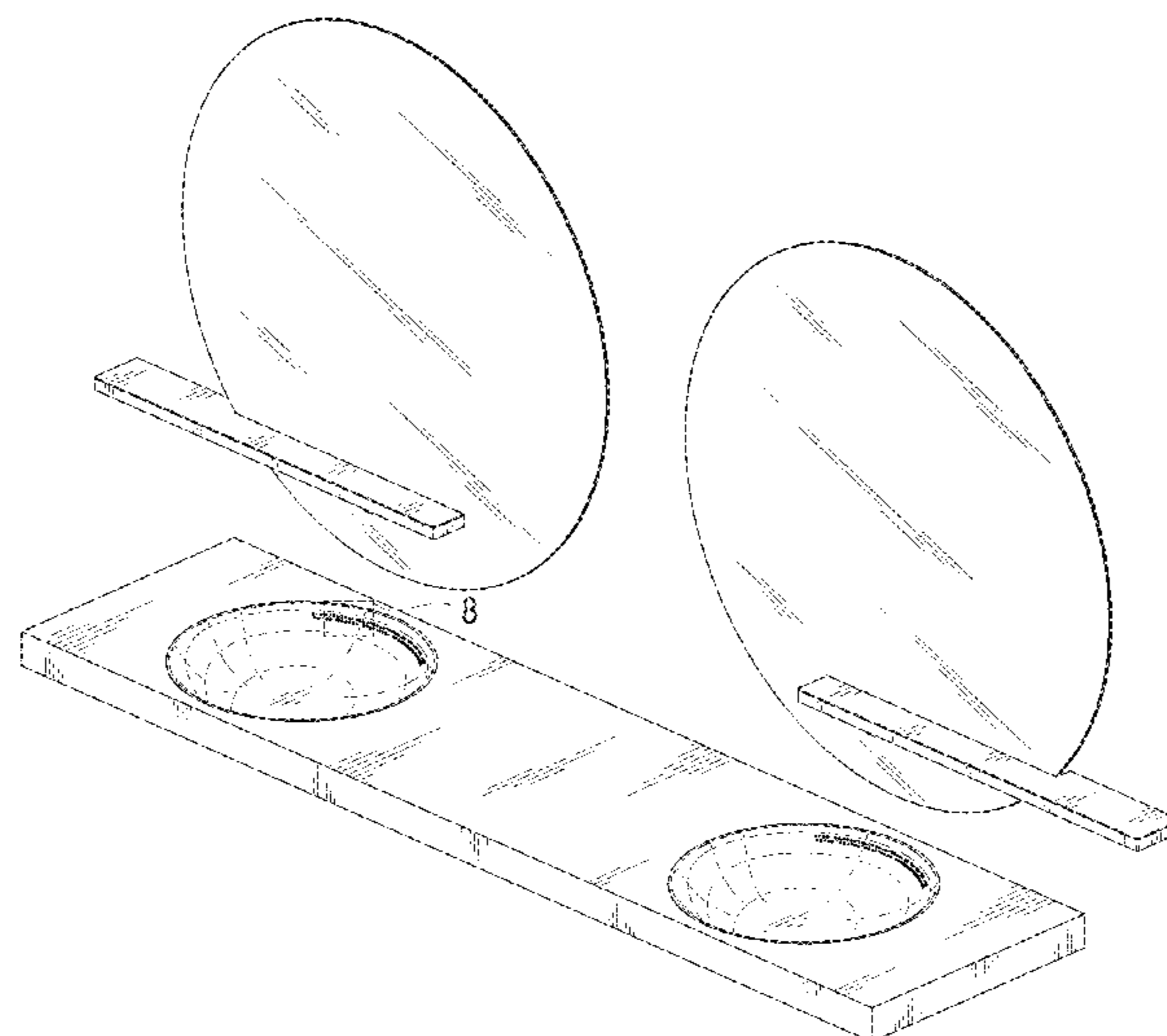

(56)

References Cited

U.S. PATENT DOCUMENTS

D553,387 S * 10/2007 Soressi D6/662
 D554,421 S * 11/2007 Sheppard D6/574
 D566,974 S * 4/2008 Lee D6/300
 D699,823 S * 2/2014 Newson D23/284
 D724,710 S * 3/2015 Clarke D23/293.1
 D727,478 S * 4/2015 Mayer D23/286
 D743,515 S * 11/2015 LeTourneau D23/284
 D867,553 S * 11/2019 Kergoet D23/284
 D923,946 S * 7/2021 Flaig D6/309

FOREIGN PATENT DOCUMENTS

CN 305112718 * 10/2018
 CN 305106879 4/2019
 EM 004076461-0014 * 6/2017

OTHER PUBLICATIONS

Kohler Bachata Undermount Stainless Steel Bathroom Sink with Luster [online], [site visited Jul. 29, 2020]. Available from internet, URL:<<https://www.homedepot.com/p/KOHLER-Bachata-Undermount-Stainless-Steel-Bathroom-Sink-in-Stainless-Steel-with-Luster-K-2609-SU-NA/206263427>> (Year: 2018).*

Anah Round Metal Mirror with Wood Shelf Combo [online], [site visited Jul. 28, 2020]. Available from internet, URL:<<https://www.overstock.com/Home-Garden/Anah-Round-Metal-Mirror-with-Wood-Shelf-Combo-Gunmetal/26890491/product.html>> (Year: 2019).*

TOTO Dartmouth 18-³/₄"×13-³/₄" Oval Undermount Bathroom Sink [online], [site visited Jul. 29, 2020]. Available from internet, URL:<<https://www.walmart.com/ip/TOTO-Dartmouth-18-3-4-x-13-3-4-Oval-Undermount-Bathroom-Sink-Cotton-White-LT641-01/21730400>> (Year: 2020).*

* cited by examiner

FIG. 1

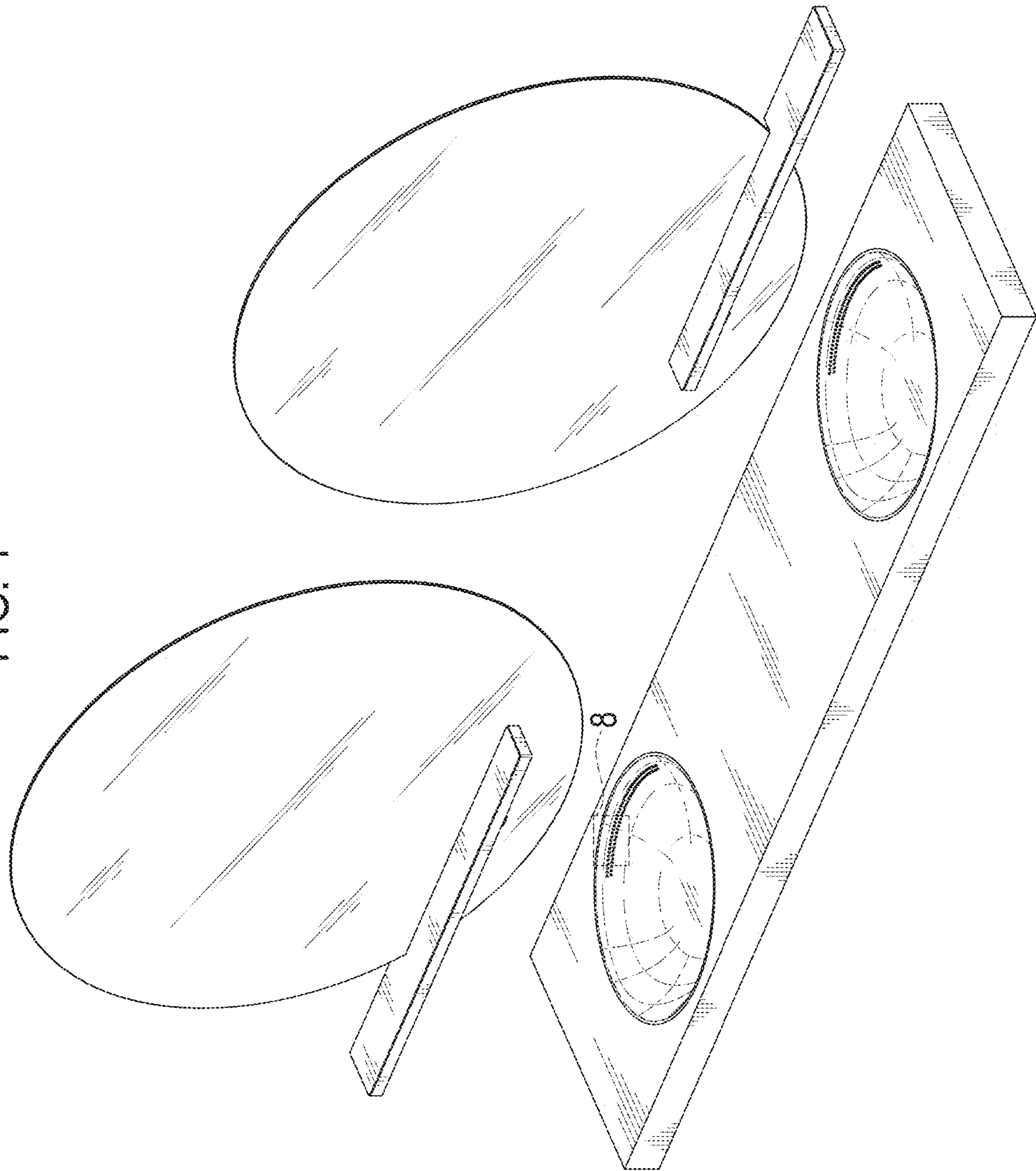

FIG. 2

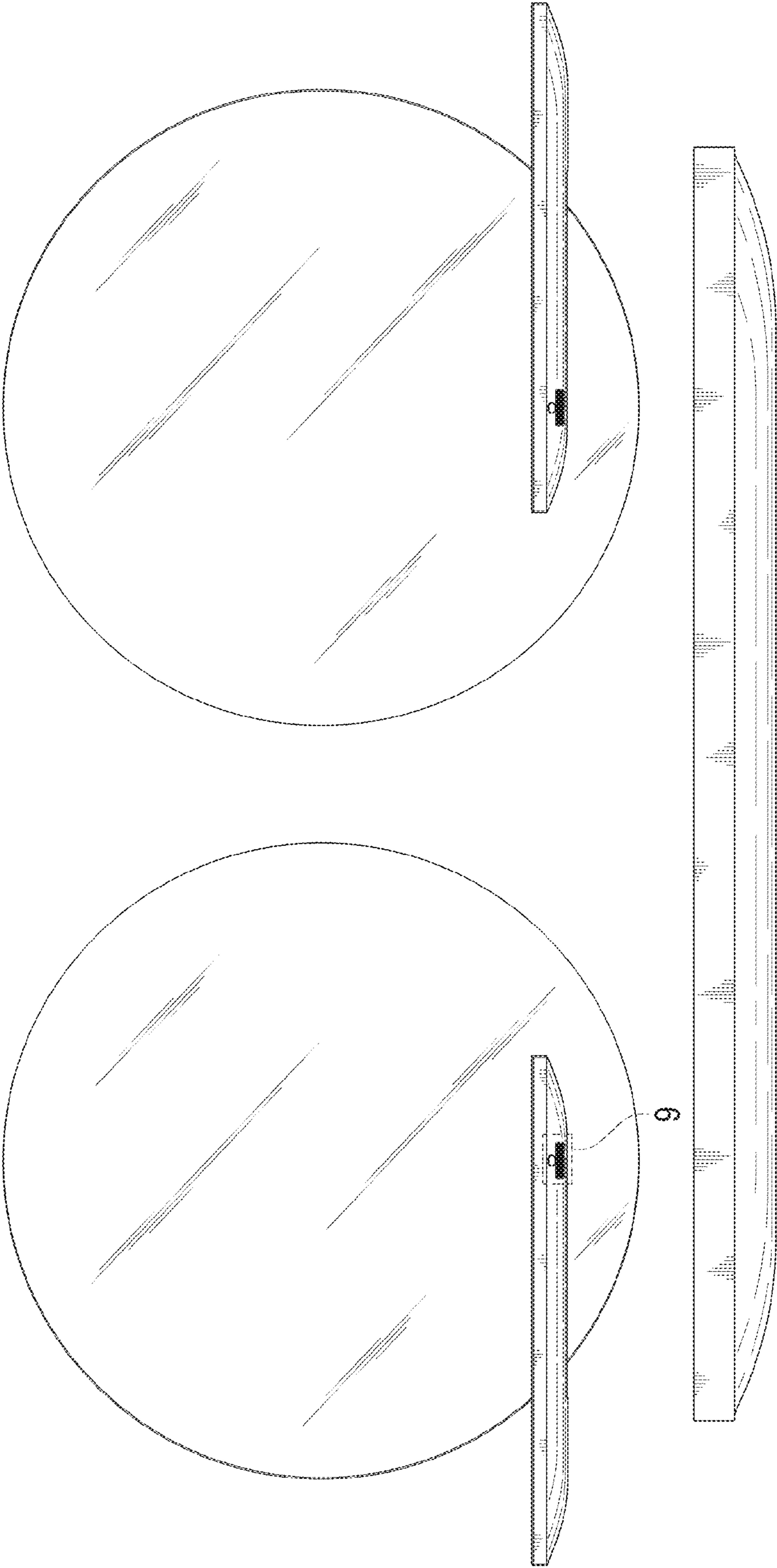

FIG. 3

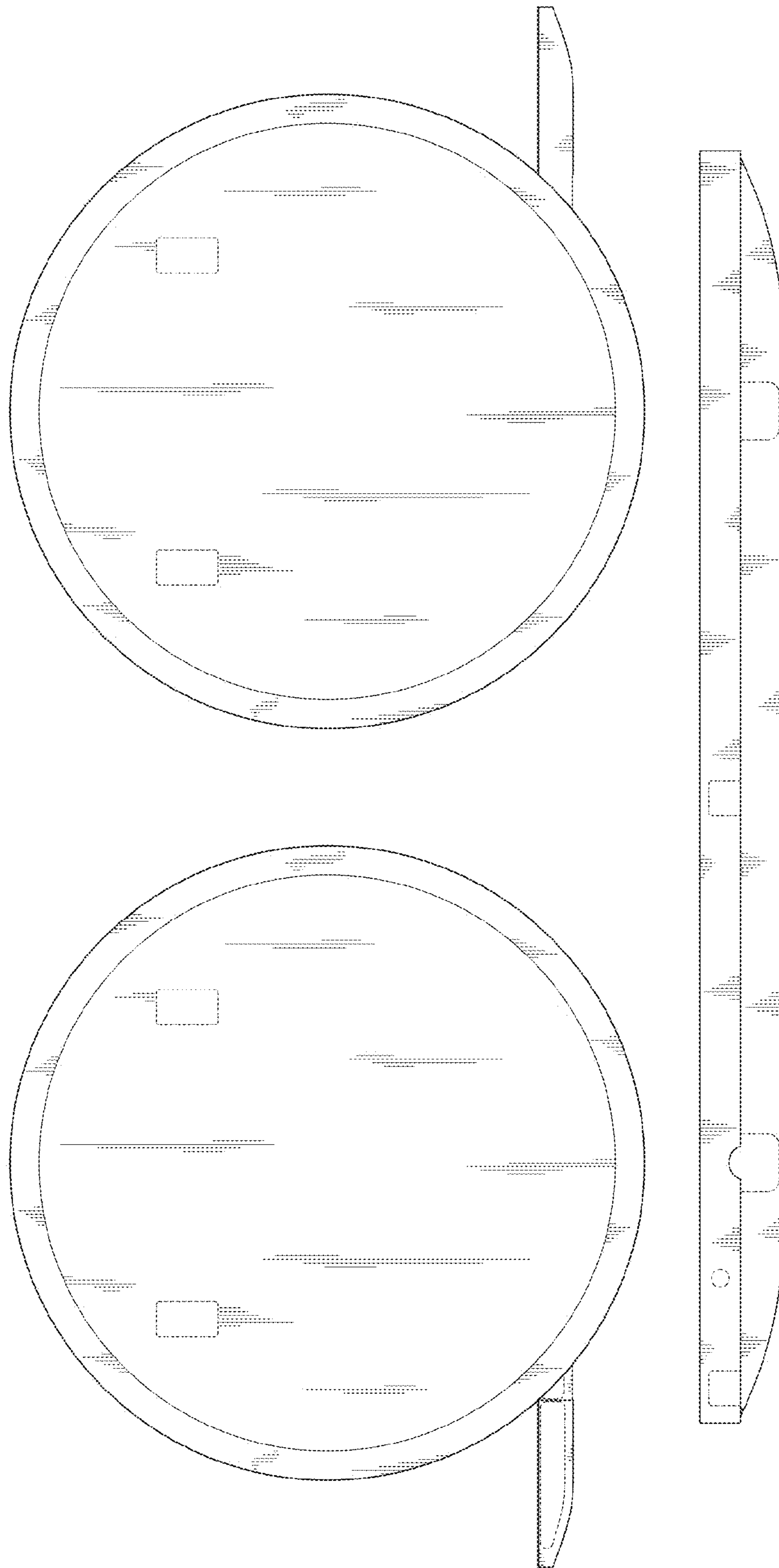

FIG. 4

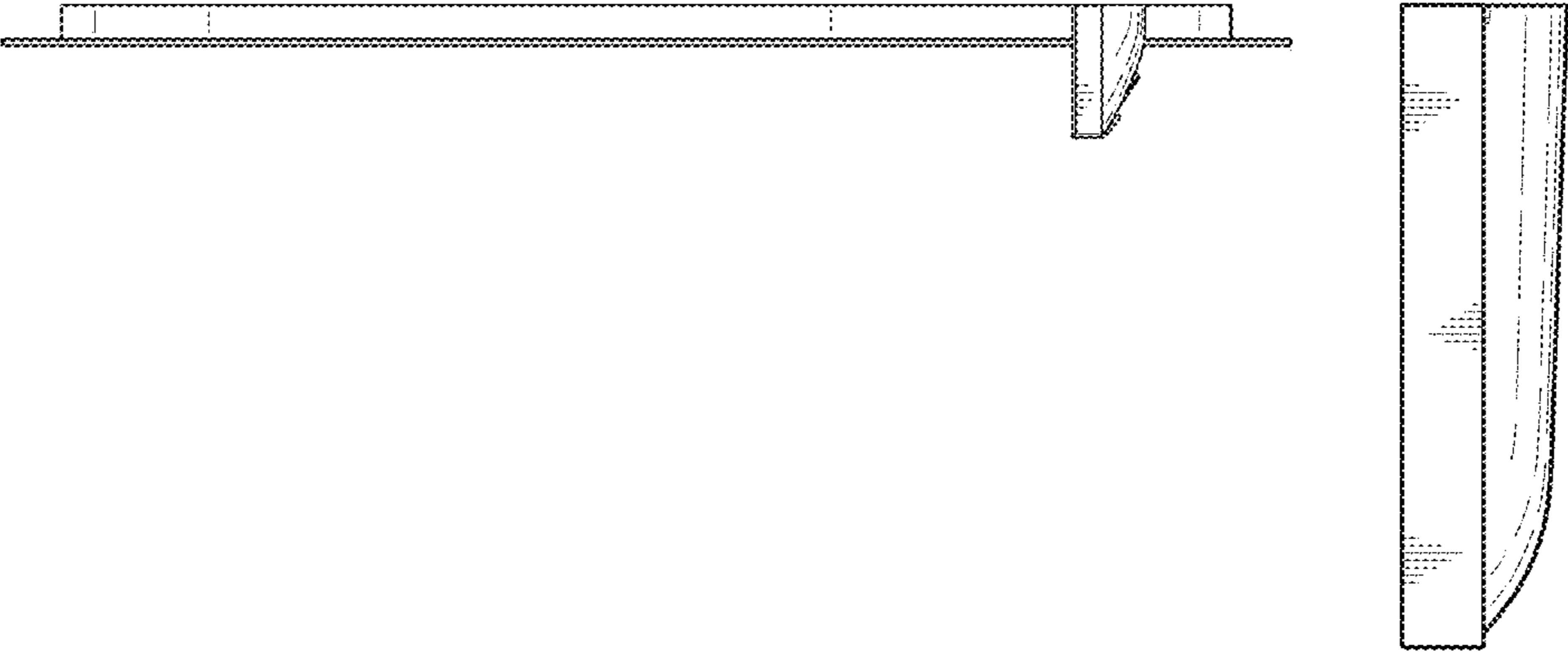

FIG. 5

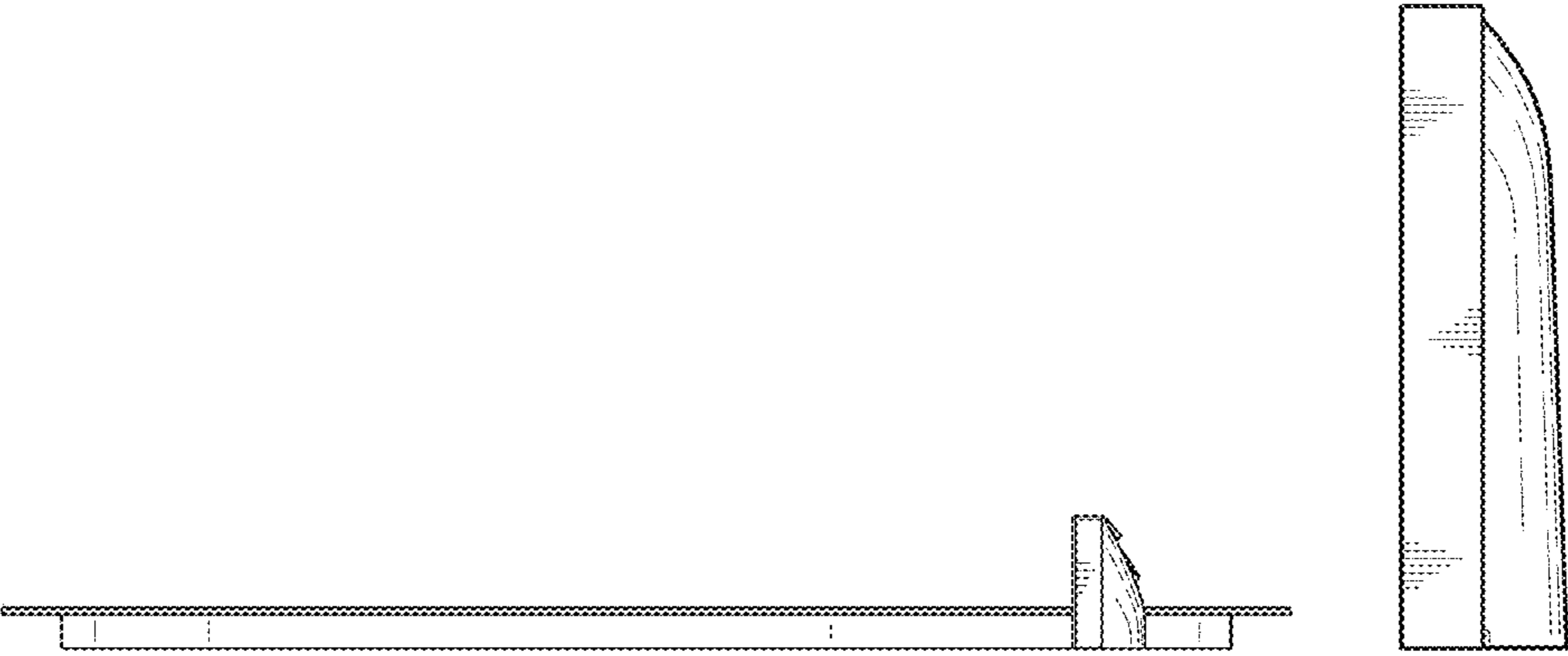

FIG. 6

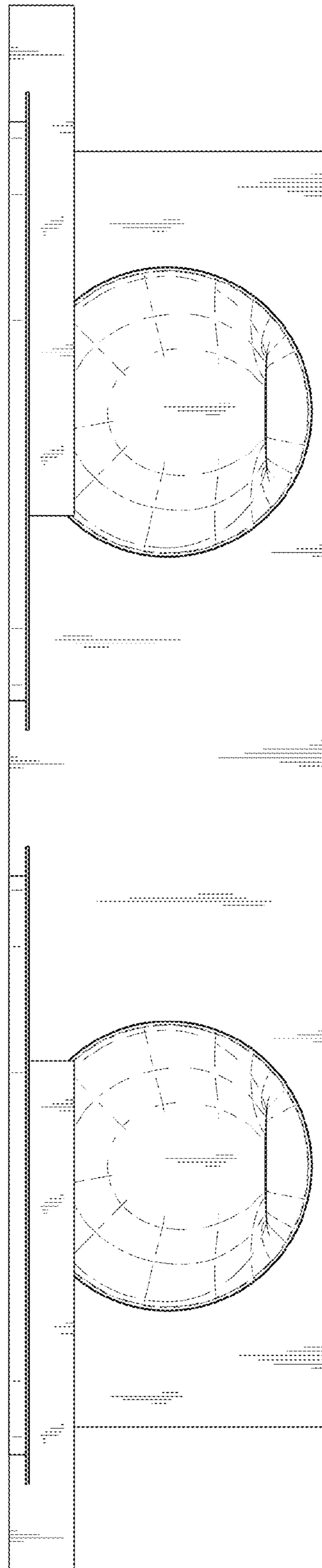

FIG. 7

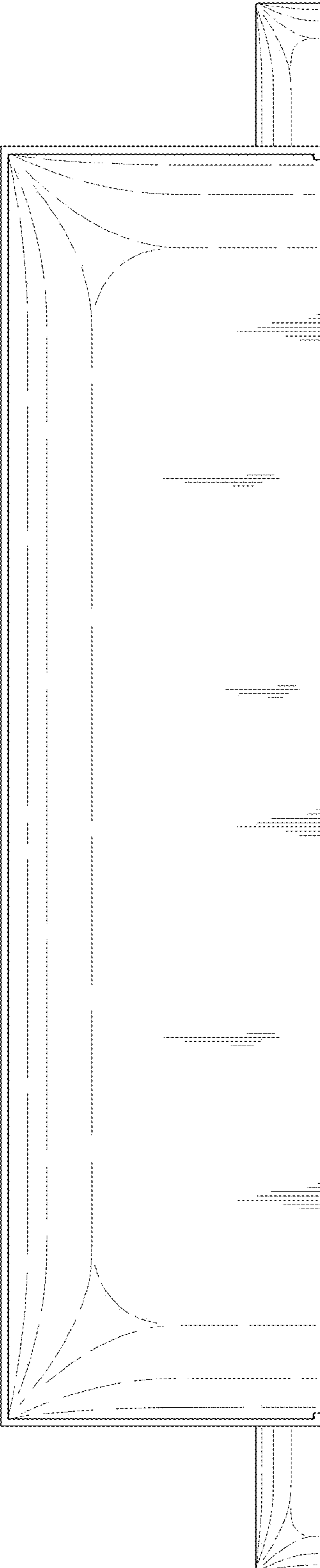

FIG. 8

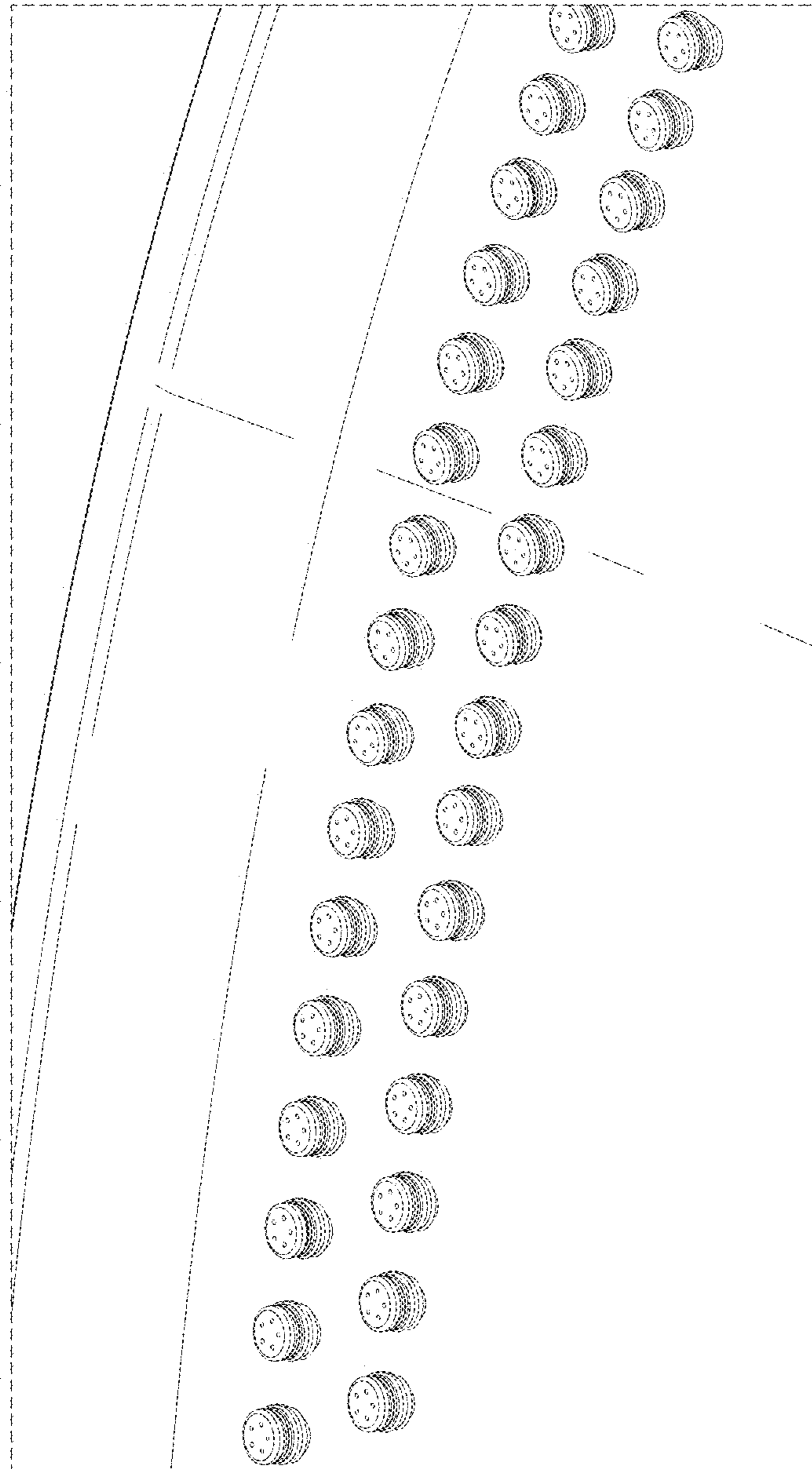

FIG. 9

