

US00D938386S

(12) **United States Design Patent**  
**Park et al.**

(10) **Patent No.:** **US D938,386 S**

(45) **Date of Patent:** **\*\* Dec. 14, 2021**

(54) **WIRELESS EARPHONE**

(71) Applicant: **LG ELECTRONICS INC.**, Seoul (KR)

(72) Inventors: **Soonhyun Park**, Seoul (KR); **Byunghyun Yi**, Seoul (KR); **Gayeong Lee**, Seoul (KR); **Gangho Woo**, Seoul (KR)

(73) Assignee: **LG ELECTRONICS INC.**, Seoul (KR)

(\*\*) Term: **15 Years**

(21) Appl. No.: **35/509,601**

(22) Filed: **Dec. 12, 2019**

(80) **Hague Agreement Data**

Int. Filing Date: **Dec. 12, 2019**  
Int. Reg. No.: **DM/206762**  
Int. Reg. Date: **Dec. 12, 2019**  
Int. Reg. Pub. Date: **Jun. 12, 2020**

(30) **Foreign Application Priority Data**

Jul. 15, 2019 (KR) ..... 30-2019-0033692

(51) **LOC (13) Cl.** ..... **14-01**

(52) **U.S. Cl.**  
USPC ..... **D14/205**

(58) **Field of Classification Search**  
USPC ..... D14/205-206, 223; D29/112  
CPC .... H04R 1/1066; H04R 1/1016; H04R 25/00;  
H04R 1/10; H04R 5/0335; H04R 5/033  
See application file for complete search history.

(56) **References Cited**

**U.S. PATENT DOCUMENTS**

D572,242 S \* 7/2008 Yang ..... D14/205  
D573,977 S \* 7/2008 Ledbetter ..... D14/205

D757,682 S \* 5/2016 Perez ..... D14/205  
D801,314 S \* 10/2017 Akana ..... D14/223  
D829,193 S \* 9/2018 Cai ..... D14/223  
D847,125 S \* 4/2019 Akana ..... D14/223  
D882,553 S \* 4/2020 Wu ..... D14/223  
D885,373 S \* 5/2020 Lundback ..... D14/223  
D905,018 S \* 12/2020 Zhu ..... D14/223  
D905,020 S \* 12/2020 Du ..... D14/223  
D906,297 S \* 12/2020 Akana ..... D14/223  
D907,607 S \* 1/2021 Deng ..... D14/223  
D908,114 S \* 1/2021 Jung ..... D14/223  
D914,652 S \* 3/2021 Chen ..... D14/223  
D916,684 S \* 4/2021 Fang ..... D14/223  
D916,685 S \* 4/2021 Fang ..... D14/223  
D918,178 S \* 5/2021 Chen ..... D14/223  
D918,182 S \* 5/2021 Chen ..... D14/223  
11,012,770 B2 \* 5/2021 Hatfield ..... H04R 1/1016  
2012/0155692 A1 \* 6/2012 Chen ..... H04R 1/1058  
381/380  
2012/0237074 A1 \* 9/2012 Aase ..... H04R 1/1075  
381/380  
2013/0004011 A1 \* 1/2013 Hayashida ..... H04R 1/345  
381/380

(Continued)

*Primary Examiner* — Michael A. Pratt

(74) *Attorney, Agent, or Firm* — Birch, Stewart, Kolasch & Birch, LLP

(57) **CLAIM**

The ornamental design for a wireless earphone, as shown and described.

**DESCRIPTION**

- 1. Wireless earphone
- 1.1 : Perspective
- 1.2 : Front
- 1.3 : Back
- 1.4 : Left
- 1.5 : Right
- 1.6 : Top
- 1.7 : Bottom

**1 Claim, 7 Drawing Sheets**

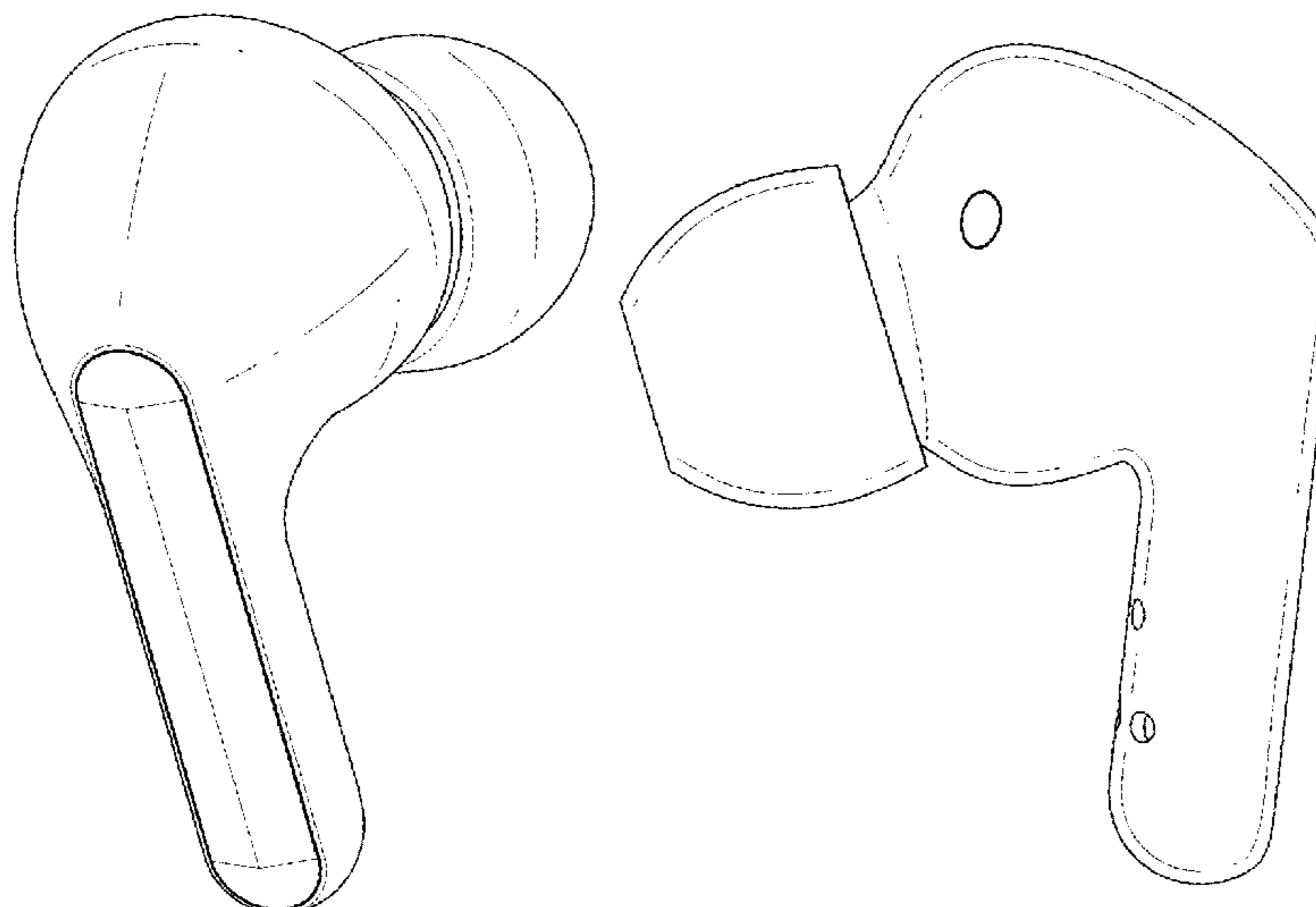

(56)

**References Cited**

U.S. PATENT DOCUMENTS

2013/0343595	A1 *	12/2013	Zorkendorfer .....	H04R 1/1016 381/380
2015/0382100	A1 *	12/2015	Azmi .....	H04R 1/1016 381/380

\* cited by examiner

1.1

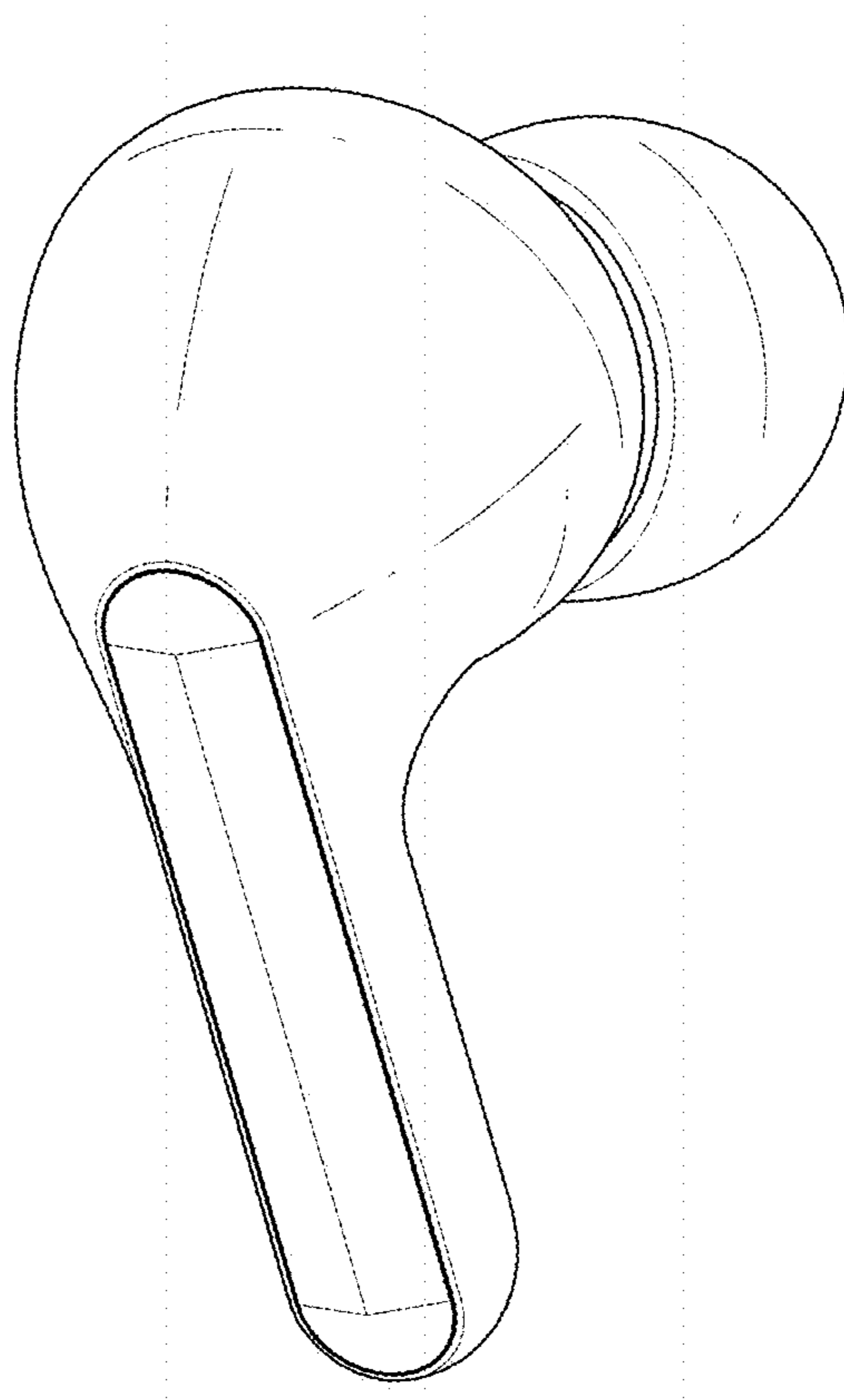

1.2

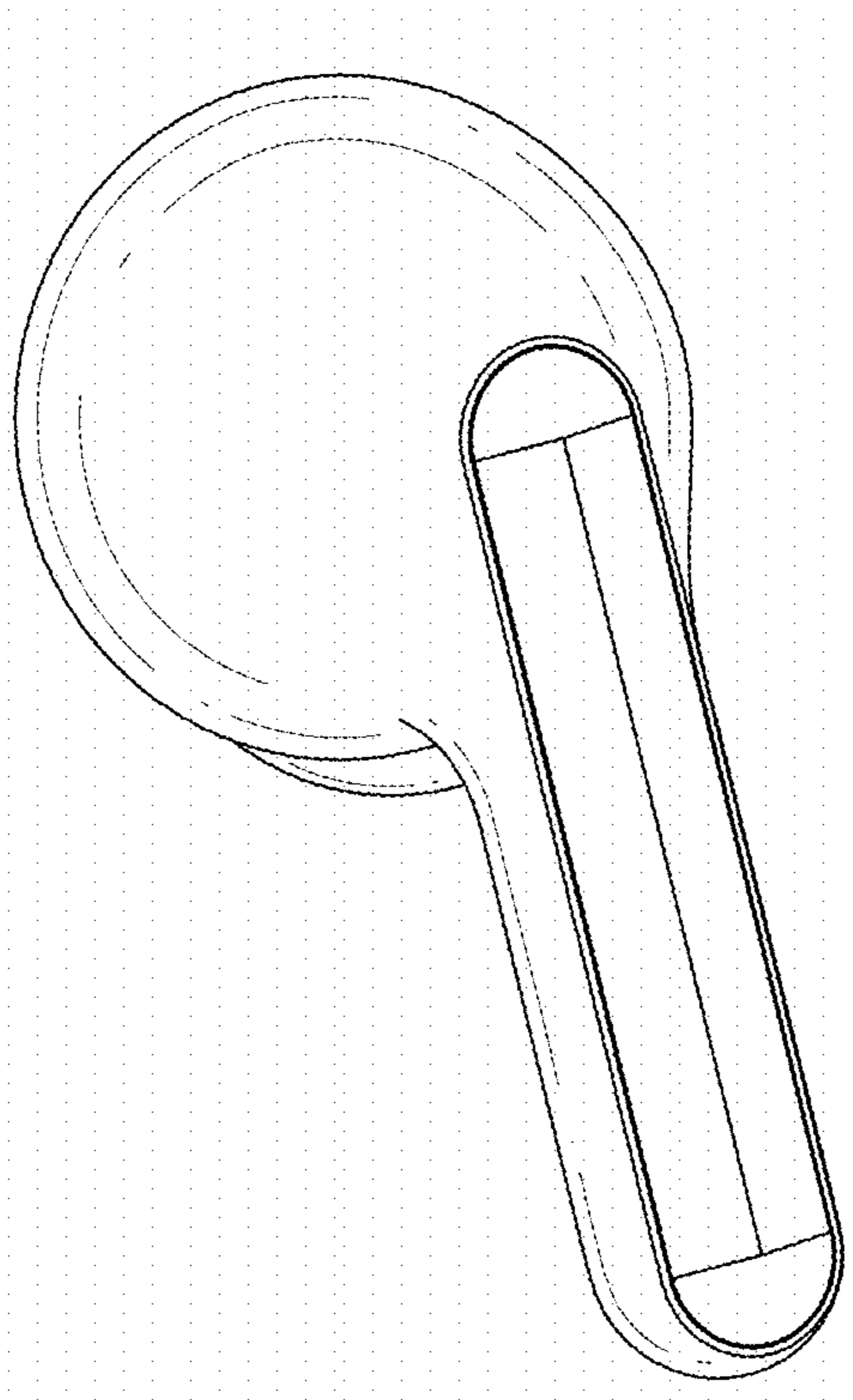

1.3

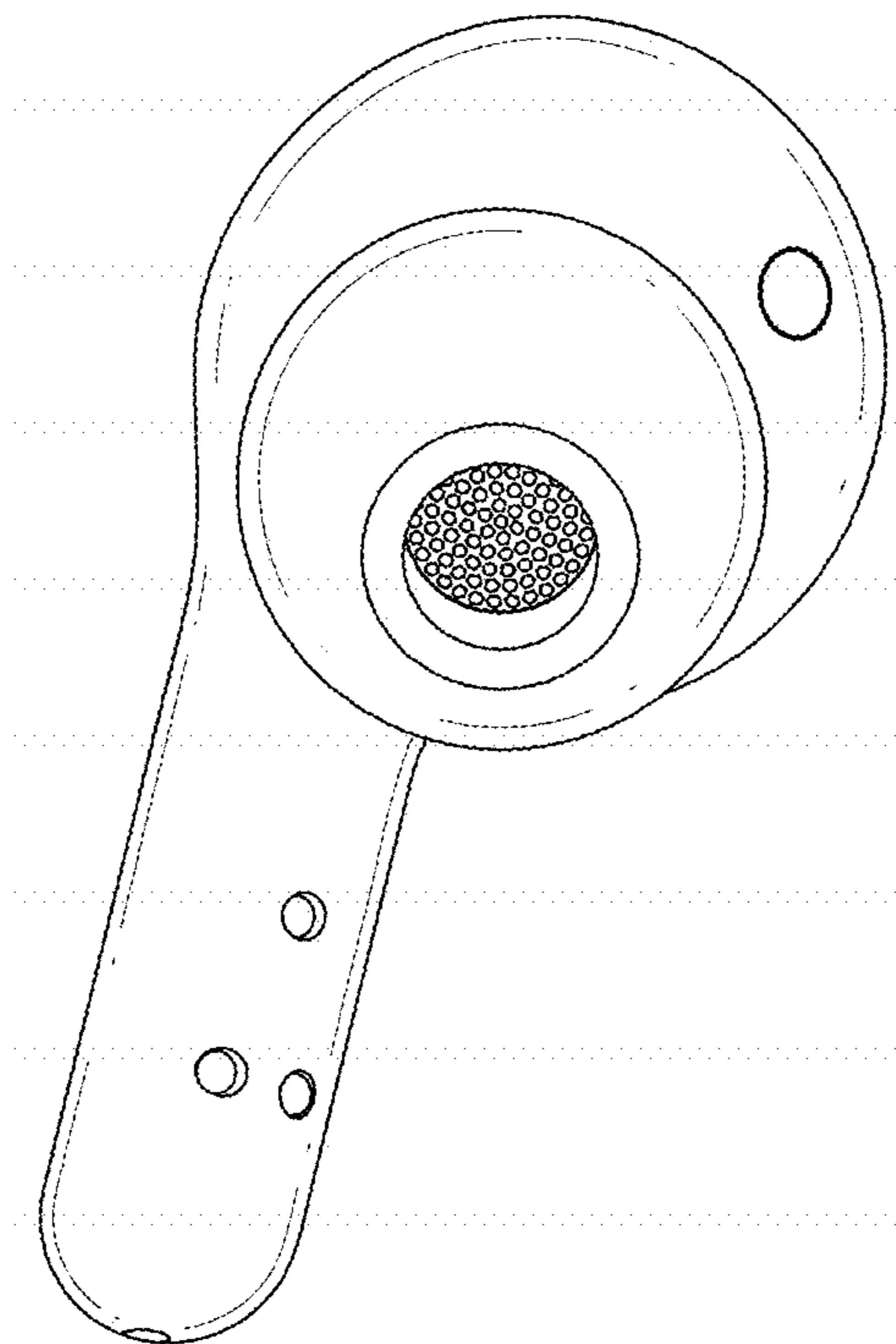

1.4

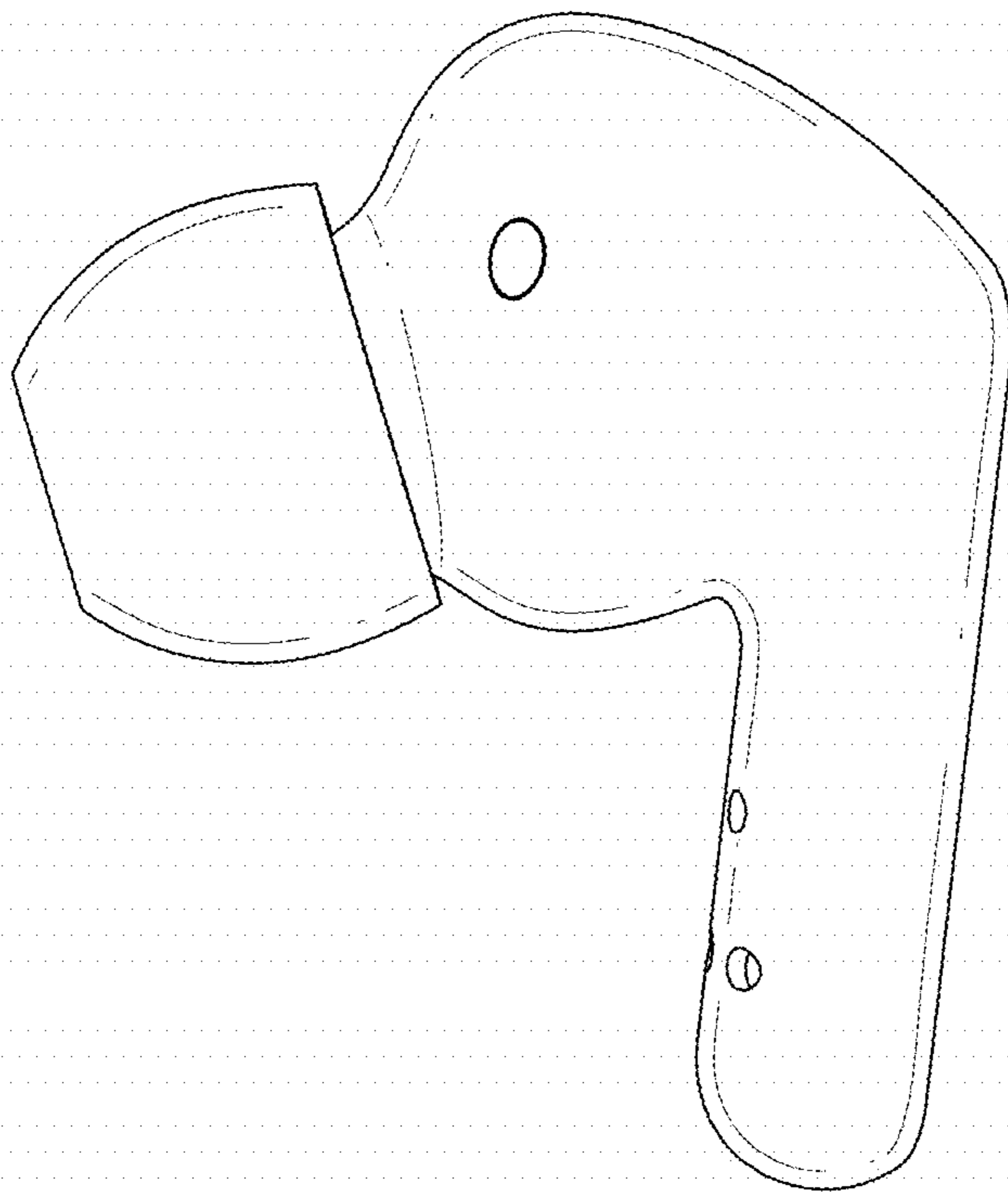

1.5

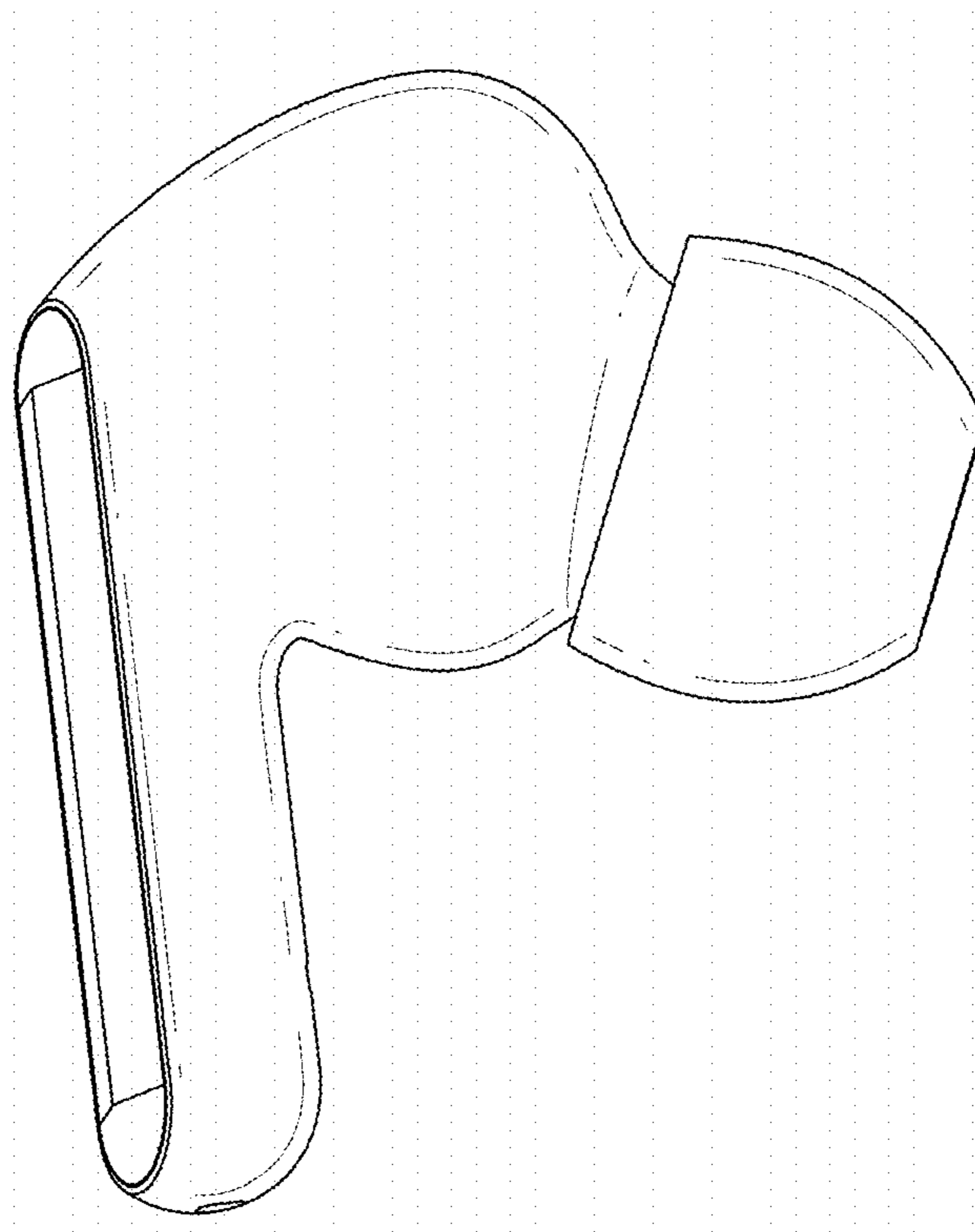

1.6

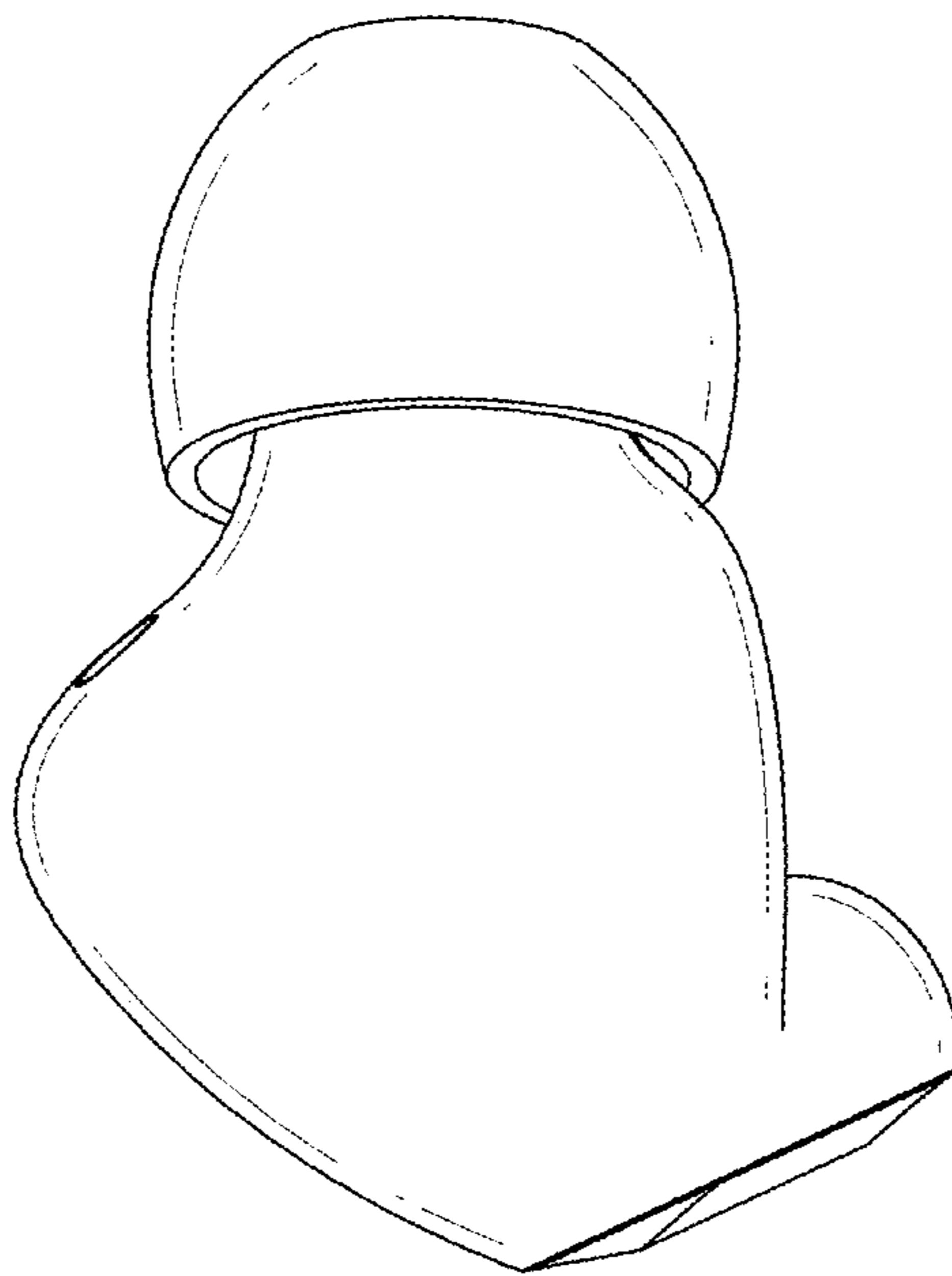



1.7

