



US00D938364S

(12) **United States Design Patent** (10) **Patent No.:** **US D938,364 S**
Ennis (45) **Date of Patent:** **** Dec. 14, 2021**

(54) **CABLE DISTRIBUTION BRIDGE**
(71) Applicant: **Switch, Ltd.**, Las Vegas, NV (US)
(72) Inventor: **Brandon Ennis**, McCarran, NV (US)
(73) Assignee: **Switch, Ltd.**, Las Vegas, NV (US)
(**) Term: **15 Years**
(21) Appl. No.: **29/695,807**
(22) Filed: **Jun. 21, 2019**
(51) **LOC (13) Cl.** **13-03**
(52) **U.S. Cl.**
USPC **D13/155**
(58) **Field of Classification Search**
USPC D13/123, 133, 139.1, 139.2, 139.4, 152,
D13/154, 155, 156, 158, 184; D8/354
See application file for complete search history.

(56) **References Cited**
U.S. PATENT DOCUMENTS
3,351,699 A * 11/1967 Merckle H02G 3/0418
174/371
4,864,082 A * 9/1989 Ono H02G 3/0437
174/97
D321,682 S * 11/1991 Henneberger D13/155
D343,828 S * 2/1994 Leitermann D13/155
D360,633 S * 7/1995 Carlson, Jr. D13/156
D402,262 S * 12/1998 Scherer D13/155

6,188,024 B1 * 2/2001 Benito-Navazo H02G 3/0608
138/111
D474,750 S * 5/2003 Dyer D13/155
2002/0141723 A1 * 10/2002 Kent G02B 6/3887
385/136

* cited by examiner
Primary Examiner — Jennifer O King
(74) *Attorney, Agent, or Firm* — Kevin D. Everage

(57) **CLAIM**
The ornamental design for a cable distribution bridge, as shown and described.

DESCRIPTION
FIG. 1 is a perspective view of the cable management bridge in accordance with the present invention;
FIG. 2 is a right elevational view of the cable distribution bridge of FIG. 1;
FIG. 3 is a left elevational view of the cable distribution bridge of FIG. 1;
FIG. 4 is a front elevational view of the cable distribution bridge of FIG. 1;
FIG. 5 is a rear elevational view of the cable distribution bridge of FIG. 1;
FIG. 6 is a top plan view of the cable distribution bridge of FIG. 1; and,
FIG. 7 is a bottom plan view of the cable distribution bridge of FIG. 1.

1 Claim, 4 Drawing Sheets

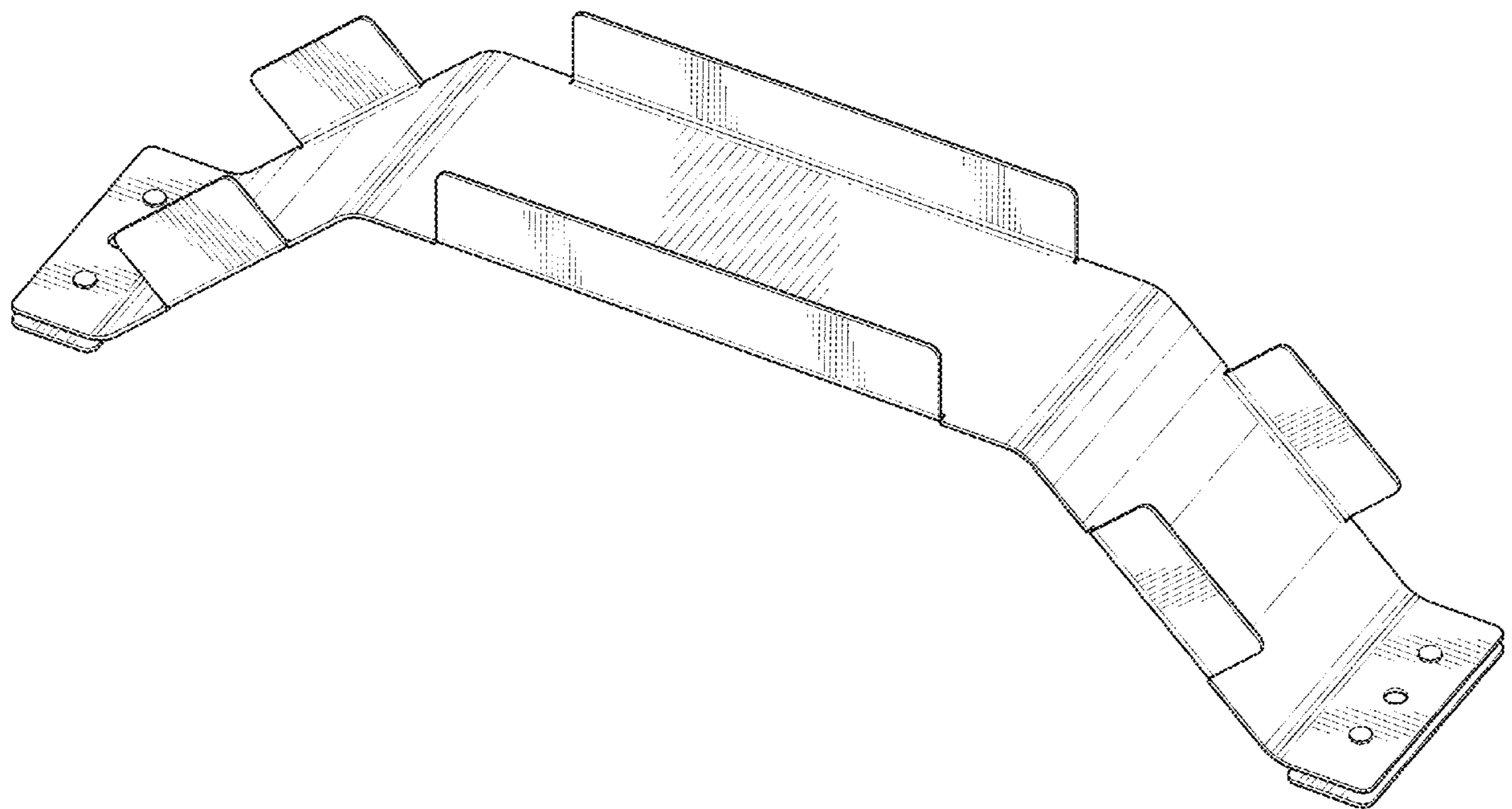

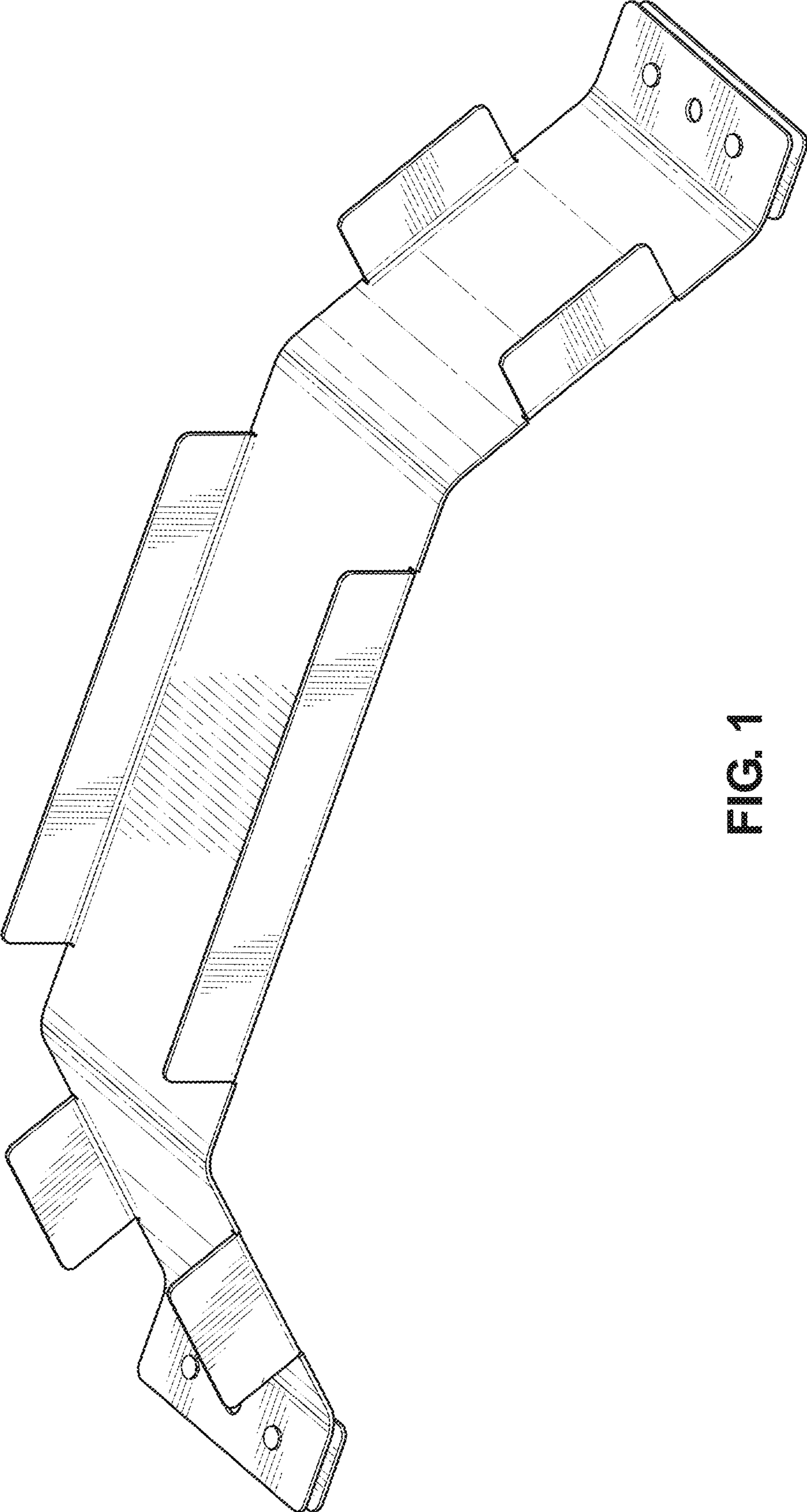

FIG. 1

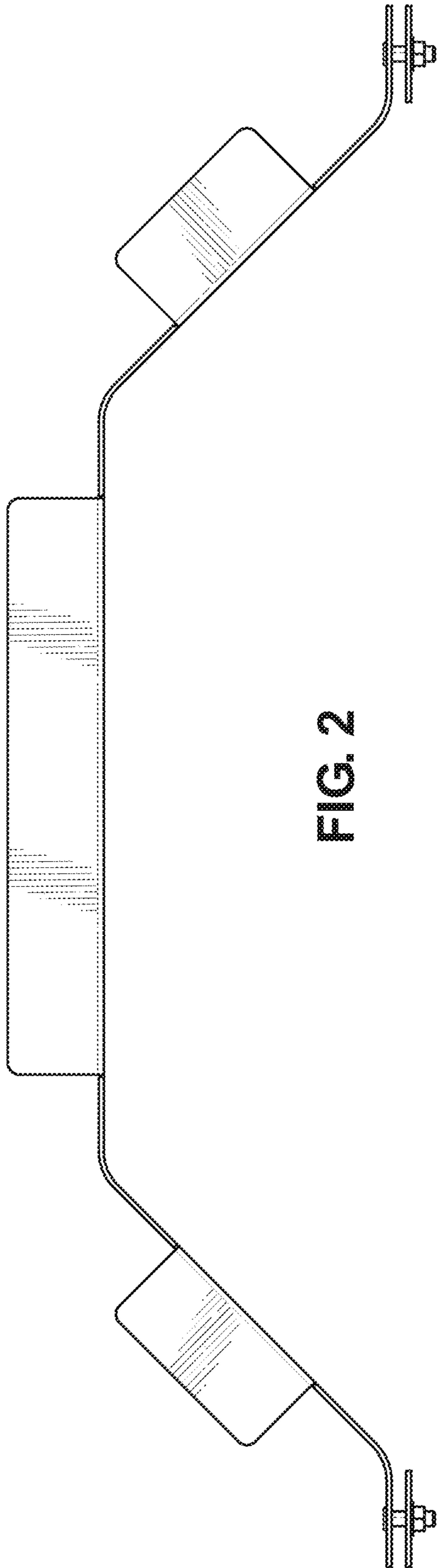

FIG. 2

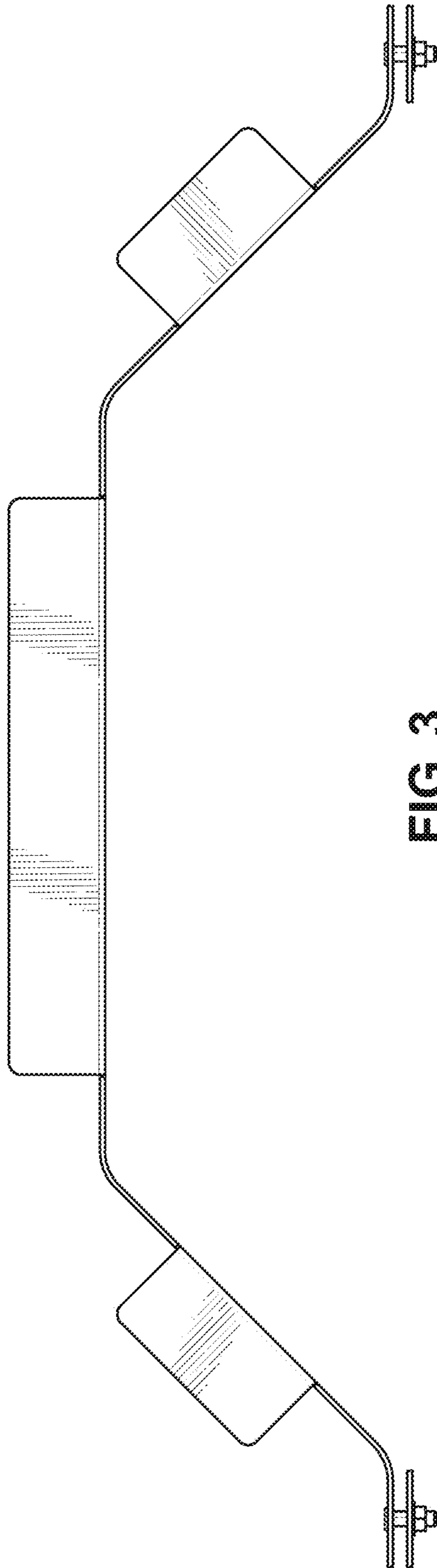

FIG. 3

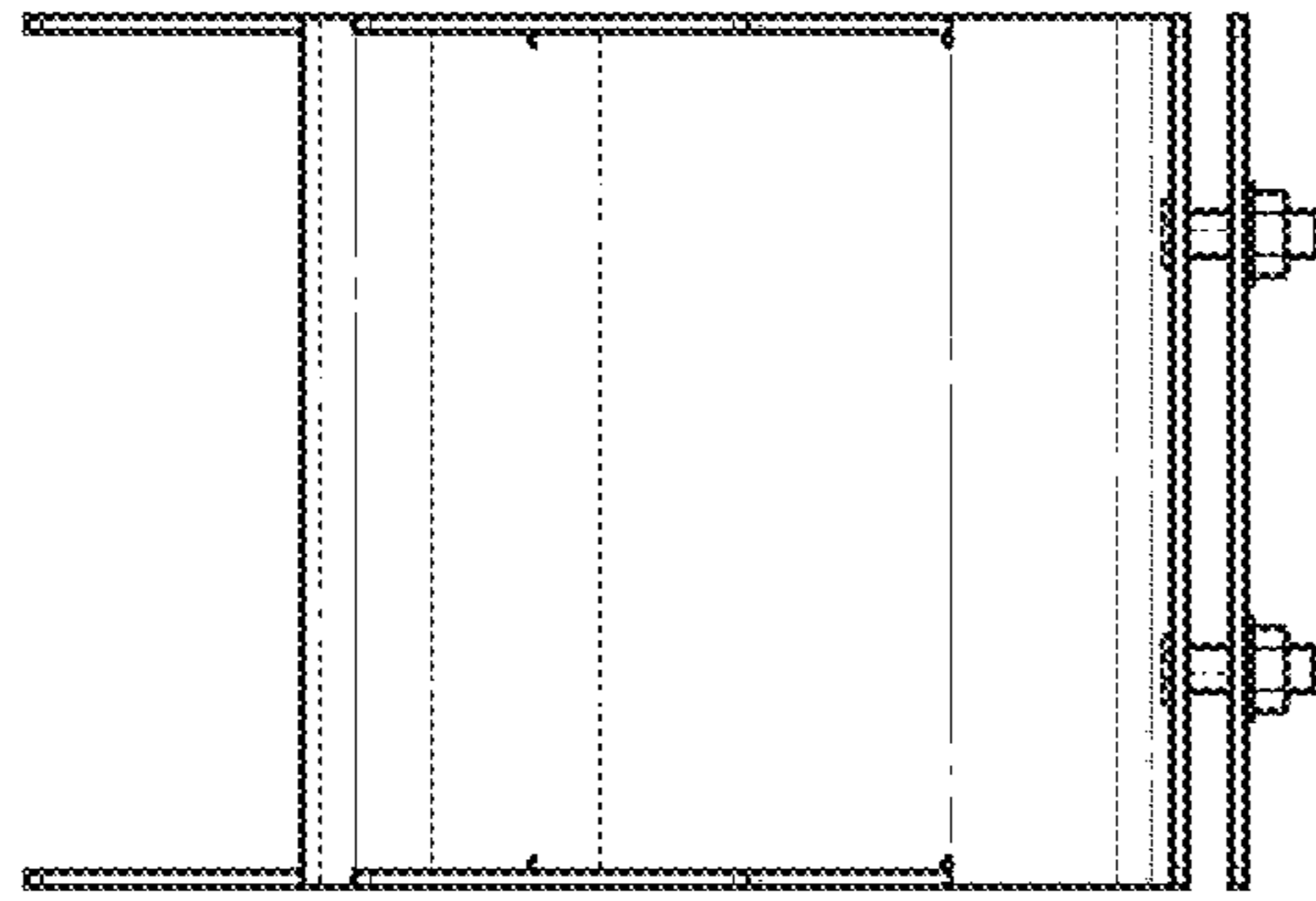

FIG. 5

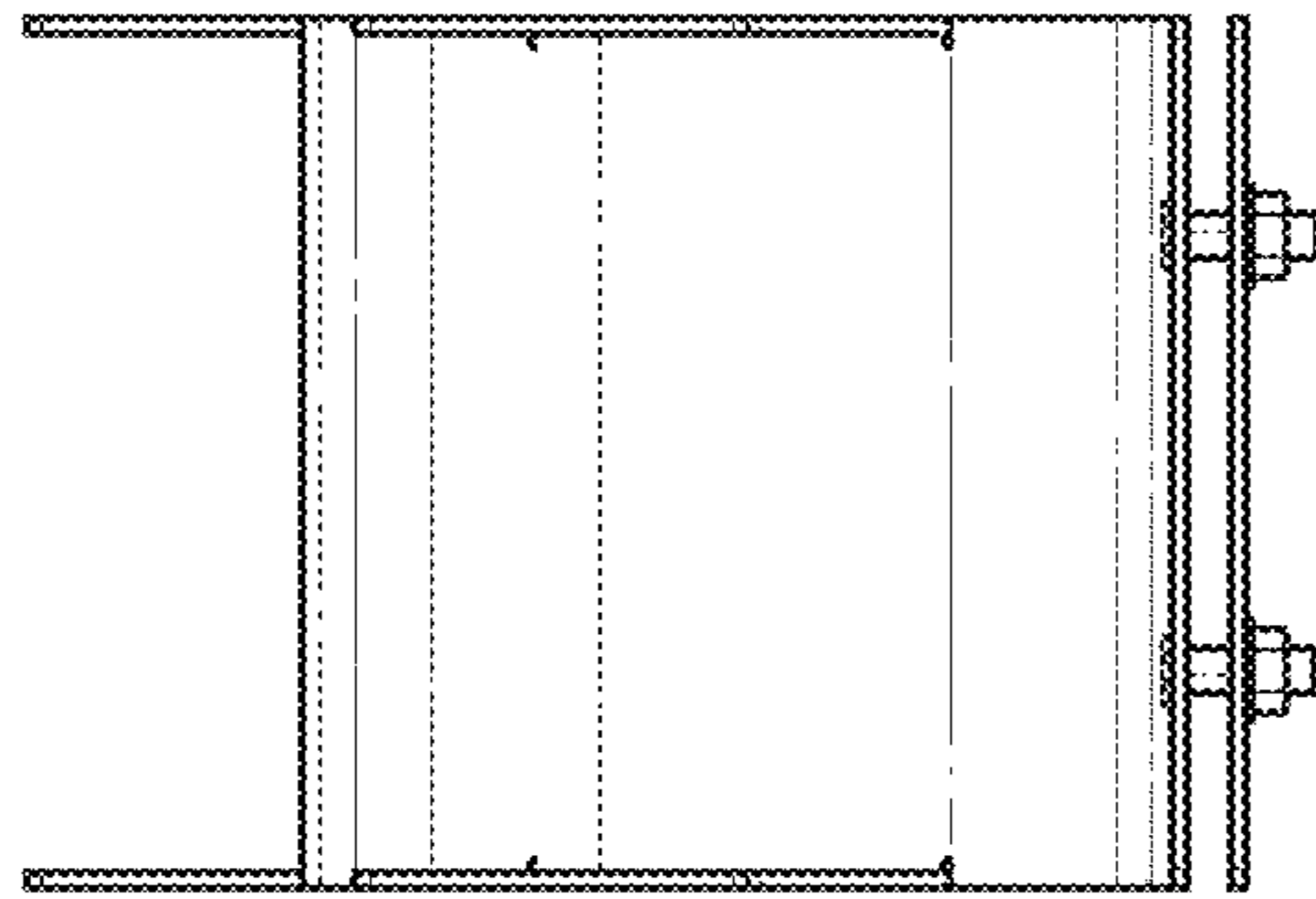

FIG. 4

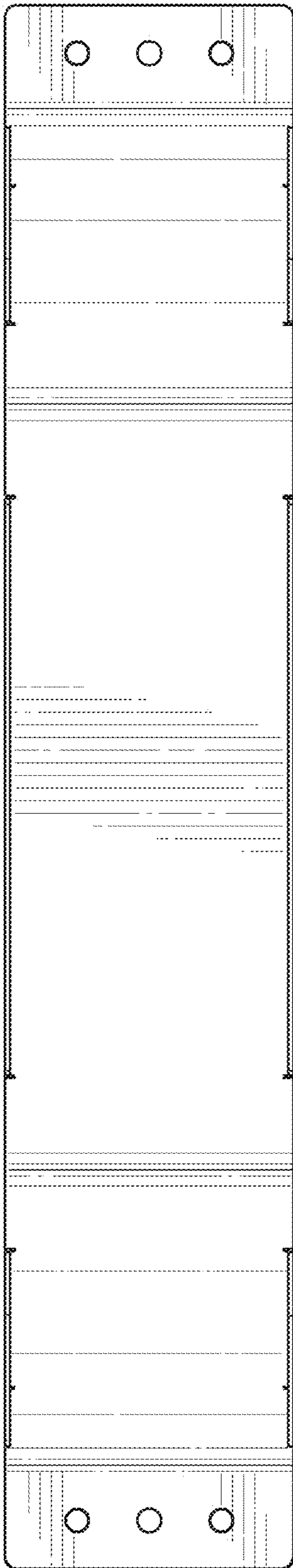

FIG. 6

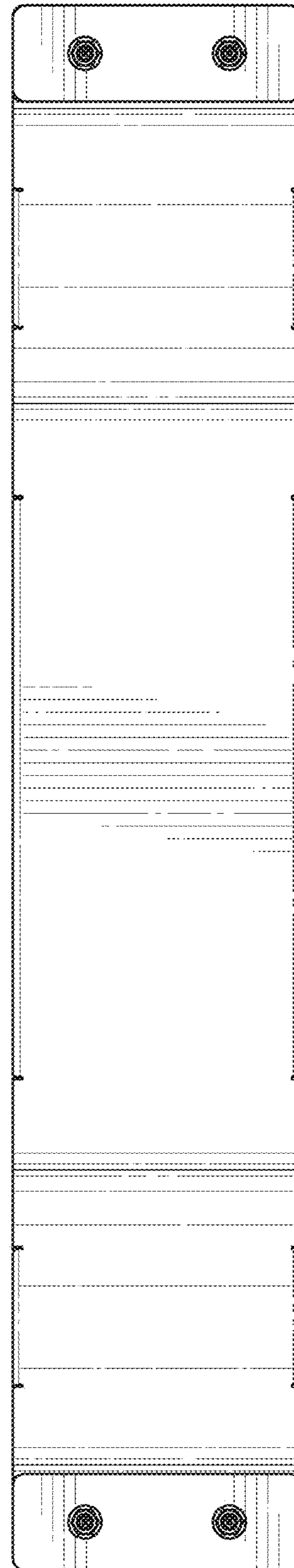

FIG. 7