



US00D938293S

(12) **United States Design Patent**
Chan

(10) **Patent No.:** **US D938,293 S**

(45) **Date of Patent:** **** Dec. 14, 2021**

(54) **SCALE DEVICE**

(71) Applicant: **Amazon Technologies, Inc.**, Seattle, WA (US)

(72) Inventor: **Danny Chan**, Fremont, CA (US)

(73) Assignee: **Amazon Technologies, Inc.**, Seattle, WA (US)

(**) Term: **15 Years**

(21) Appl. No.: **29/714,265**

(22) Filed: **Nov. 21, 2019**

(51) **LOC (13) Cl.** **10-04**

(52) **U.S. Cl.**
USPC **D10/91; D10/87**

(58) **Field of Classification Search**
USPC D10/91, 92, 46, 83, 87; 177/128, 256, 177/74, 179

(Continued)

(56) **References Cited**

U.S. PATENT DOCUMENTS

D448,691 S * 10/2001 Montagnino D10/92
D498,157 S * 11/2004 Kobayakawa D10/92

(Continued)

FOREIGN PATENT DOCUMENTS

CN 304710135 * 11/2017
CN 305602366 * 7/2019

(Continued)

OTHER PUBLICATIONS

Amazon, Dash Smart Shelf, Date first available Jan. 23, 2021, [online]retrieved Jun. 11, 2021, available from https://www.amazon.com/Dash-Smart-Shelf/dp/B07RRYWPPX/ref=sr_1_3?dchild=1&keywords=kitchen%2Bsmart%2Bscale&qid=1623434030&s=amazon-devices&sr=1-3&th=1 (Year: 2021).*

(Continued)

Primary Examiner — Keli L Hill

Assistant Examiner — Sara S Sahneh

(74) *Attorney, Agent, or Firm* — Lee & Hayes, P.C.

(57) **CLAIM**

The ornamental design for a scale device, as shown and described.

DESCRIPTION

FIG. 1 is a top, front, right-side perspective view of a first embodiment of a scale device;
FIG. 2 is a top, front, left-side perspective view thereof;
FIG. 3 is a front view thereof;
FIG. 4 is a back view thereof;
FIG. 5 is a left-side view thereof;
FIG. 6 is a right-side view thereof;
FIG. 7 is a top view thereof;
FIG. 8 is a bottom view thereof;
FIG. 9 is a top, front, right-side perspective view of a second embodiment of a scale device;
FIG. 10 is a bottom, front, left-side perspective view thereof;
FIG. 11 is a front view thereof;
FIG. 12 is a back view thereof;
FIG. 13 is a left-side view thereof;
FIG. 14 is a right-side view thereof;
FIG. 15 is a top view thereof;
FIG. 16 is a bottom view thereof;
FIG. 17 is a top, front, right-side perspective view of a third embodiment of a scale device;
FIG. 18 is a bottom, front, left-side perspective view thereof;
FIG. 19 is a front view thereof;
FIG. 20 is a back view thereof;
FIG. 21 is a left-side view thereof;
FIG. 22 is a right-side view thereof;
FIG. 23 is a top view thereof; and,
FIG. 24 is a bottom view thereof.

The dashed broken lines depict portions of the scale device which form no part of the claimed design.

1 Claim, 24 Drawing Sheets

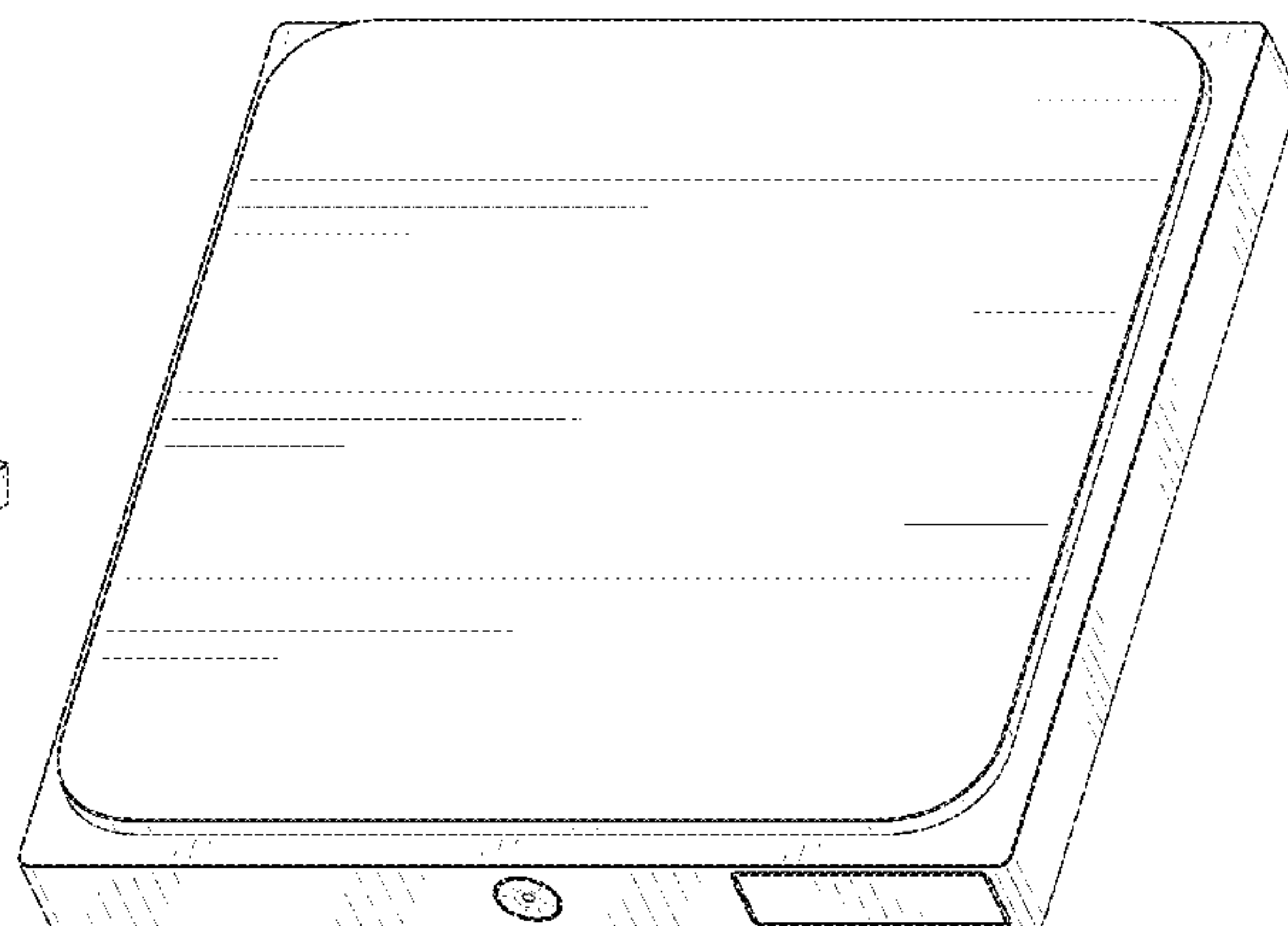
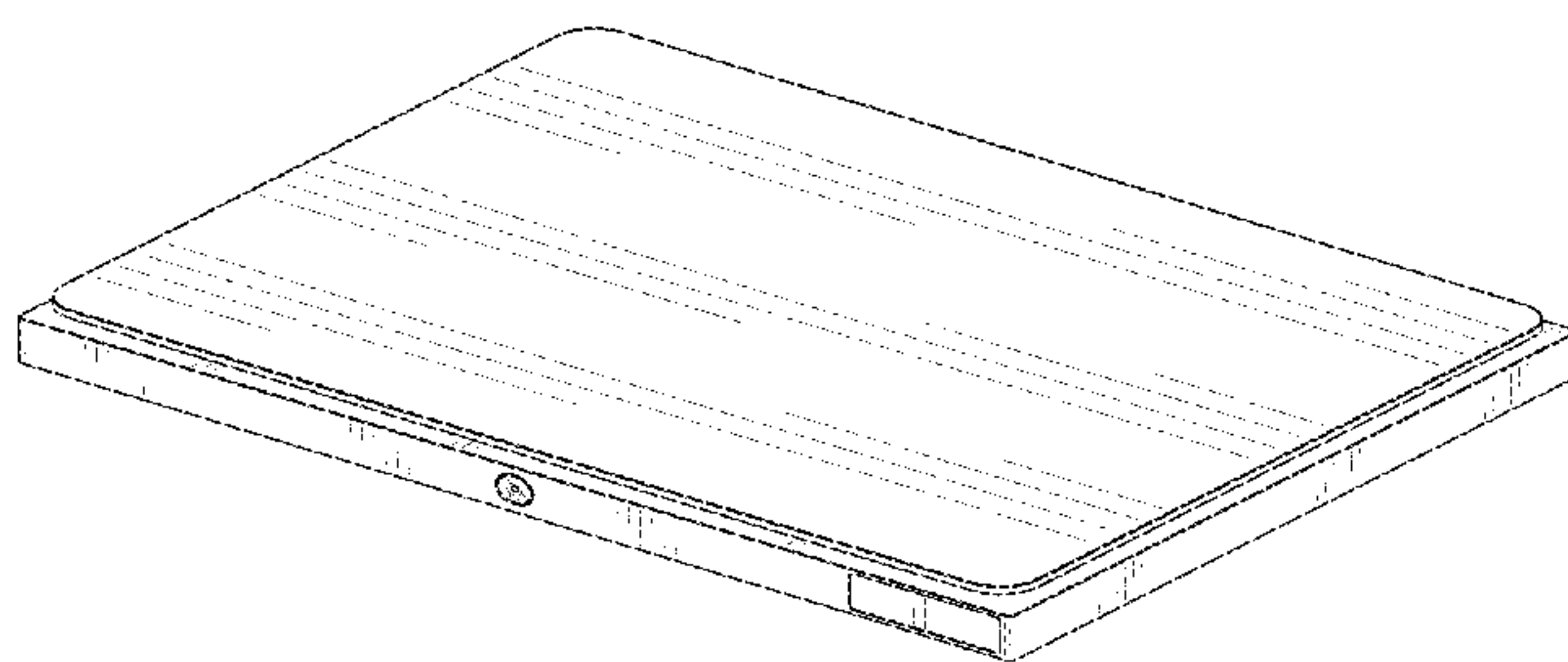

(58) **Field of Classification Search**

CPC G01G 21/286; G01G 21/28; G01G 21/00;
 G01G 21/30; G01G 23/3728; G01G
 23/3735; G01G 19/44; G01G 3/14; G01G
 19/46; G01G 19/48; G01G 19/50; G01G
 21/44; G01G 19/414; G01G 19/4144;
 G01G 19/42; F16F 1/123; A61B 5/053;
 A61B 5/4872; A61B 5/0537; A61B
 5/4869; A61B 5/6825; A61B 5/6829;
 A61B 5/7445; G06Q 20/3678; G06Q
 20/387; G06Q 20/065; G06Q 20/36;
 G06Q 20/06; G09B 19/00

See application file for complete search history.

(56) **References Cited**

U.S. PATENT DOCUMENTS

D526,230 S	*	8/2006	Aglassinger	D10/92
D531,075 S	*	10/2006	Vantine	D10/92
D538,190 S	*	3/2007	Aglassinger	D10/92
D550,575 S	*	9/2007	Petrucci	D10/92
D686,518 S	*	7/2013	Kaiser	D10/92
D801,837 S	*	11/2017	Tsai	D10/91
D808,287 S	*	1/2018	Liang	D10/92
D812,503 S	*	3/2018	Garner	D10/92

D883,118 S	*	5/2020	Centen	D10/91
D902,364 S	*	11/2020	Theodorson	D23/335
2003/0178233 A1	*	9/2003	Montagnino	G01G 19/44 177/142

FOREIGN PATENT DOCUMENTS

CN	305714352	*	11/2019
CN	6091738	*	6/2020
GB	6001497	*	10/2016
JP	D1469280	*	9/2012

OTHER PUBLICATIONS

Reflex, Digital smart food kitchen baking postal Scale, Date first available Dec. 20, 2013, [online]retrieved Jun. 11, 2021, available from https://www.amazon.com/ReFleX-Wireless-Bluetooth-Smart-Scale/dp/B00HFH5AX8/ref=pd_sbs_2/134-384pd_rd_w=ksHAI&pf_rd_p=a5925d26-9630-40f3-a011-d858608ac88b&pf_rd_r=2T (Year: 2013).*

Reflex, Smart Chef Pocket Smart Food Scale, Date first available Aug. 15, 2016, [online]retrieved Jun. 11, 2021, available from https://www.amazon.com/reflex-Smart-Chef-Pocket-Scale/dp/B01HVYEVU2/ref=sr_1_154?crid=IU1E44SKTGCL&dchild=1&keywords=kitchen+smart+scale&qid=1623433250&srefix=KITCHEN+smart+scal (Year: 2016).*

* cited by examiner

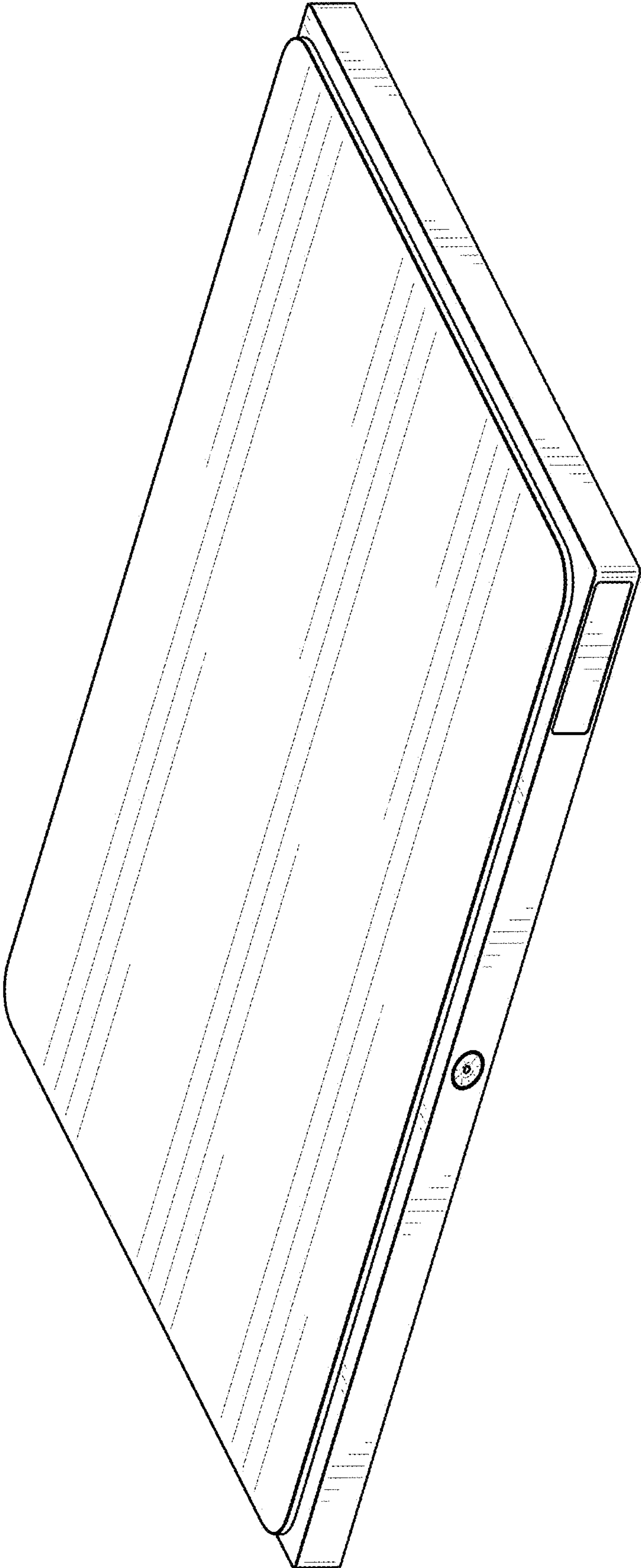

FIG. 1

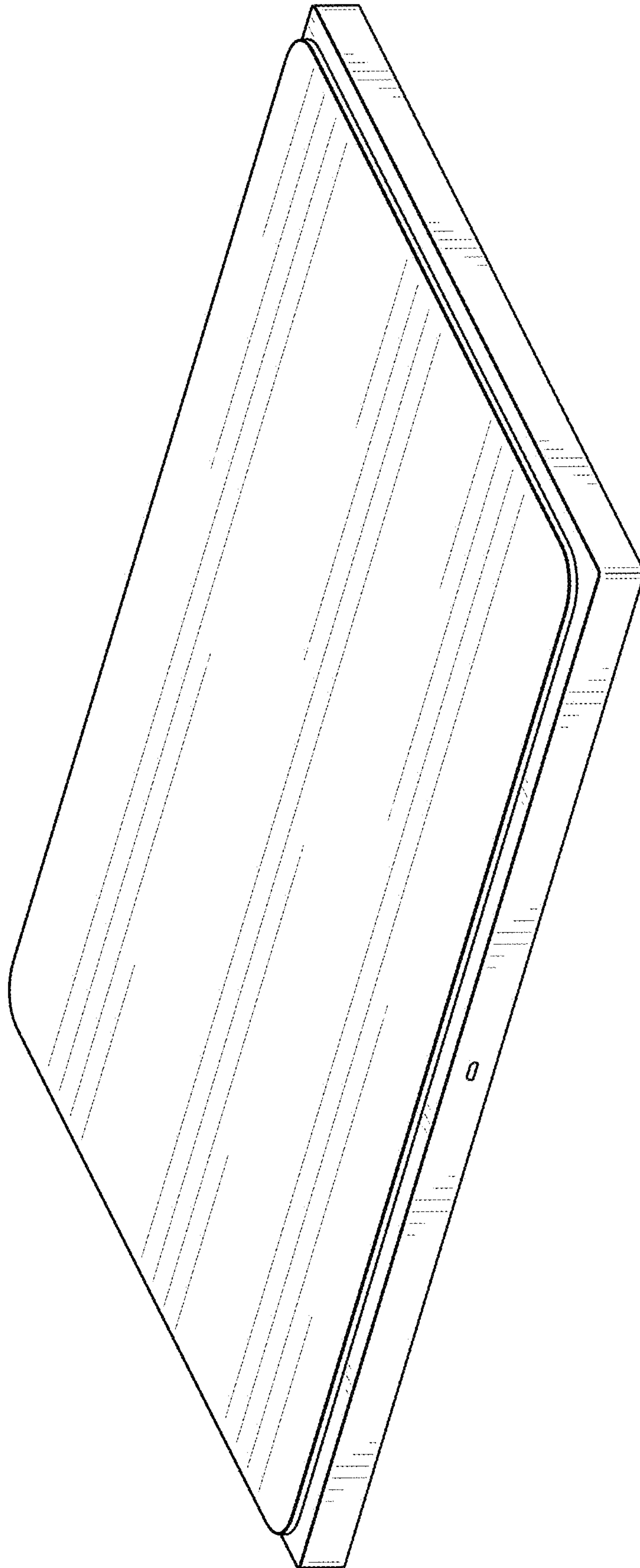

FIG. 2

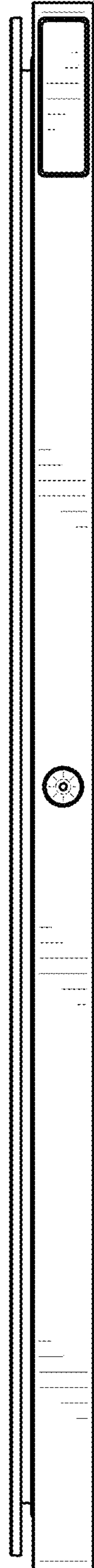

FIG. 3

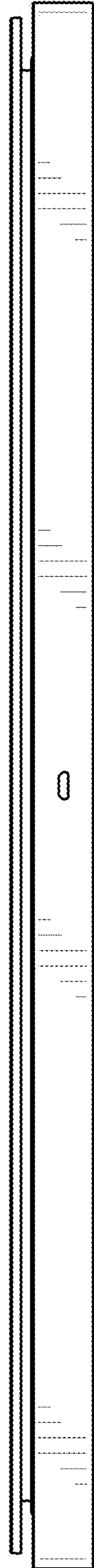

FIG. 4

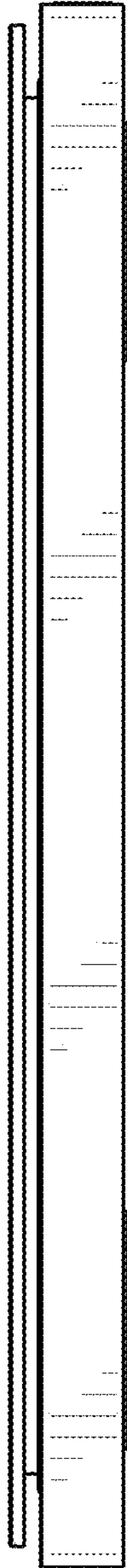

FIG. 5

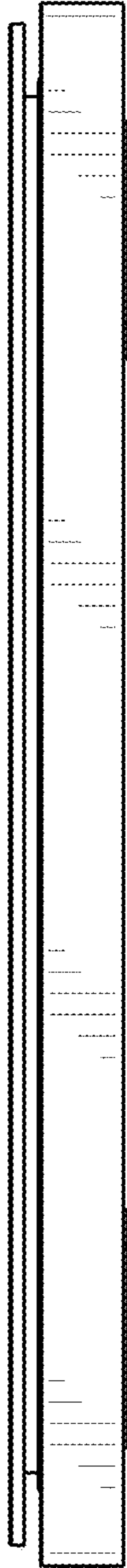

FIG. 6

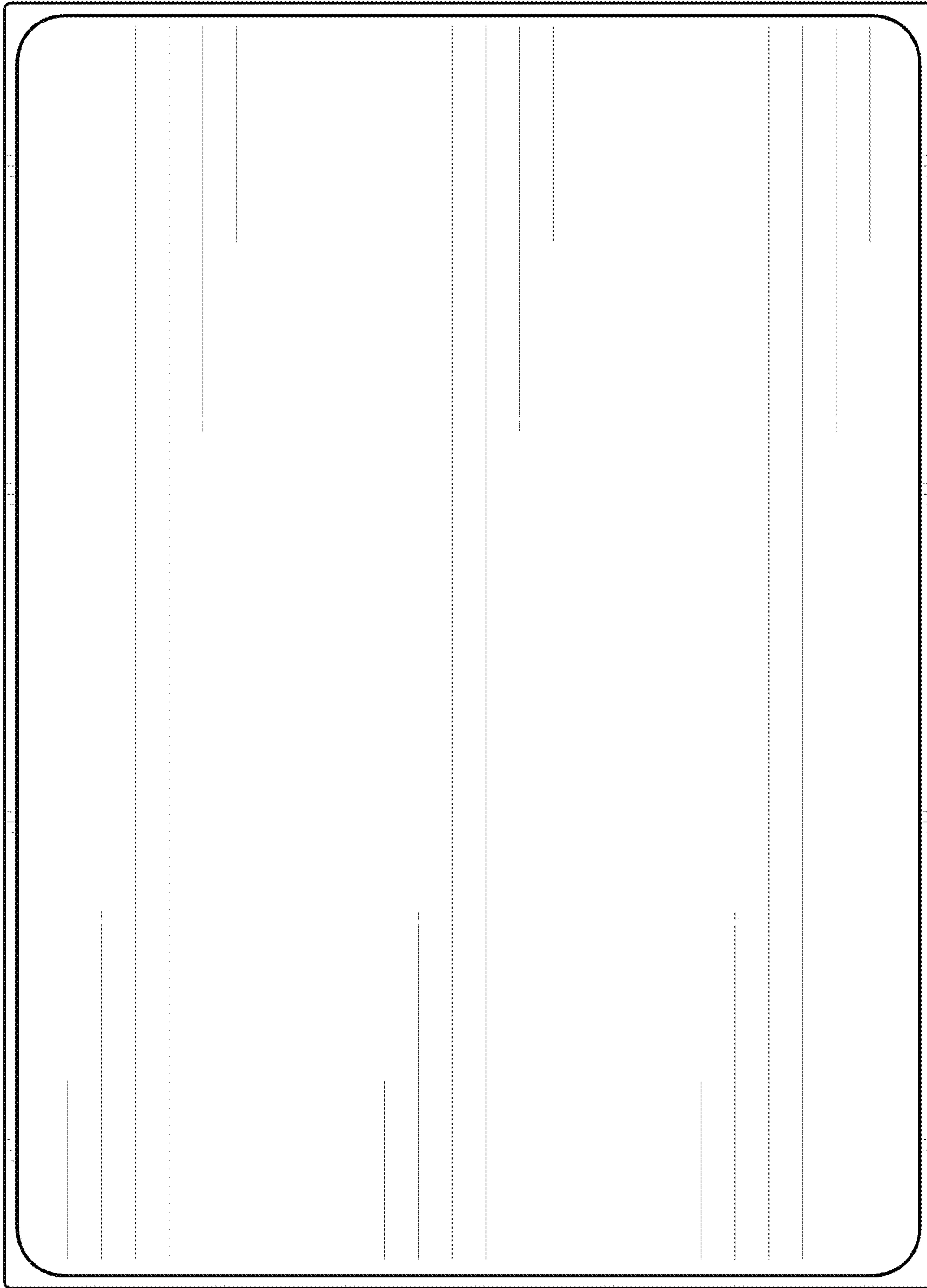

FIG. 7

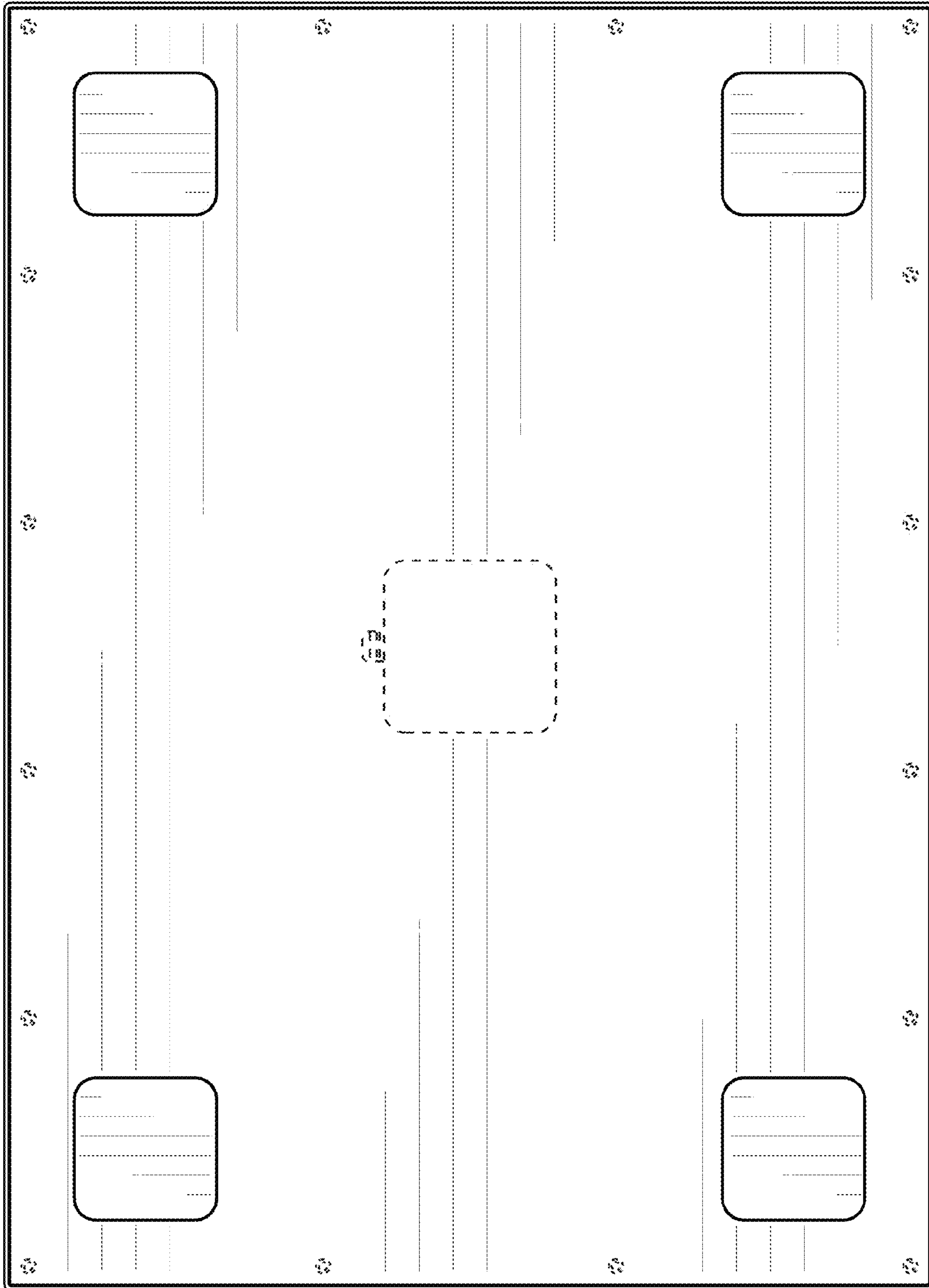

FIG. 8

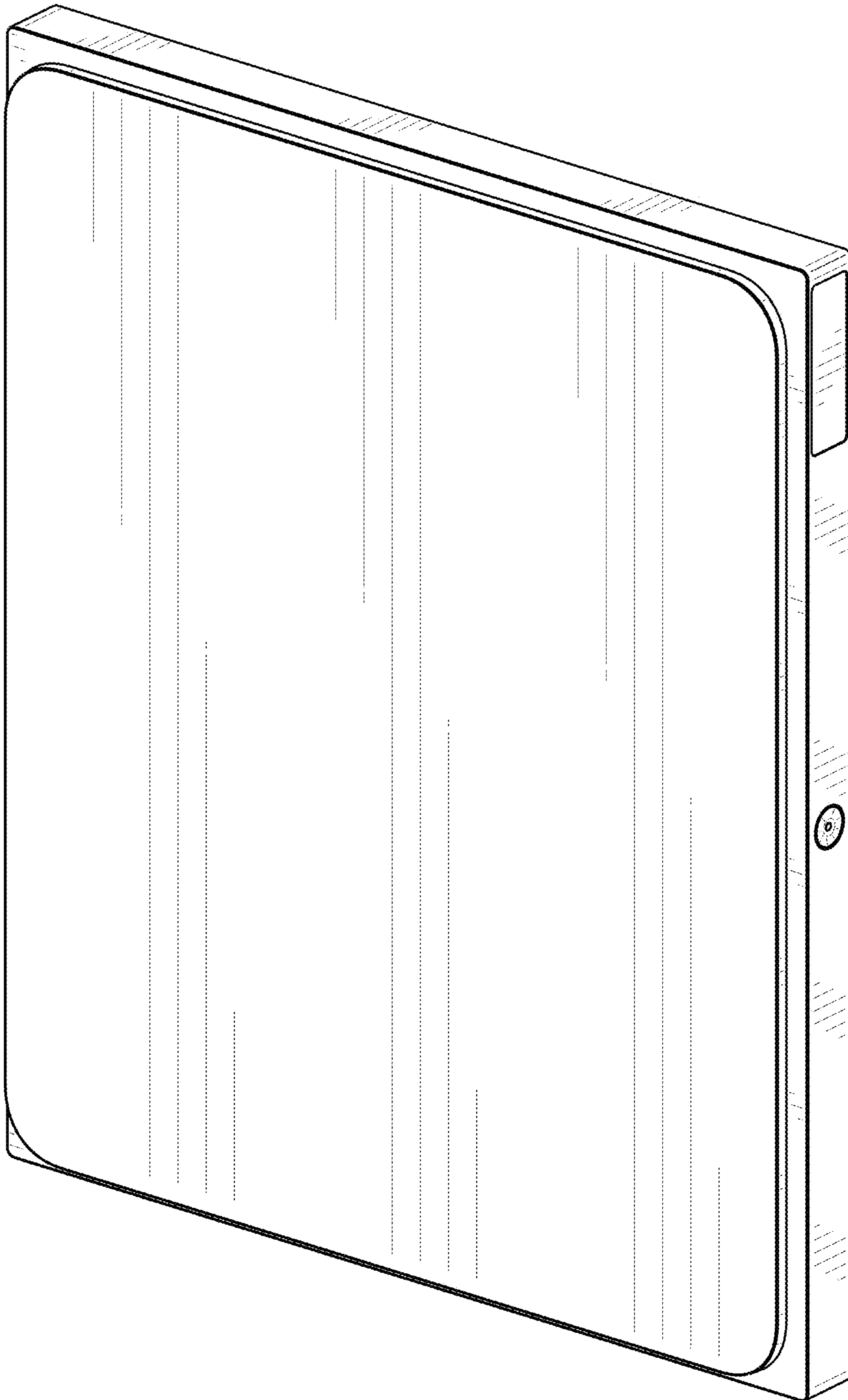

FIG. 9

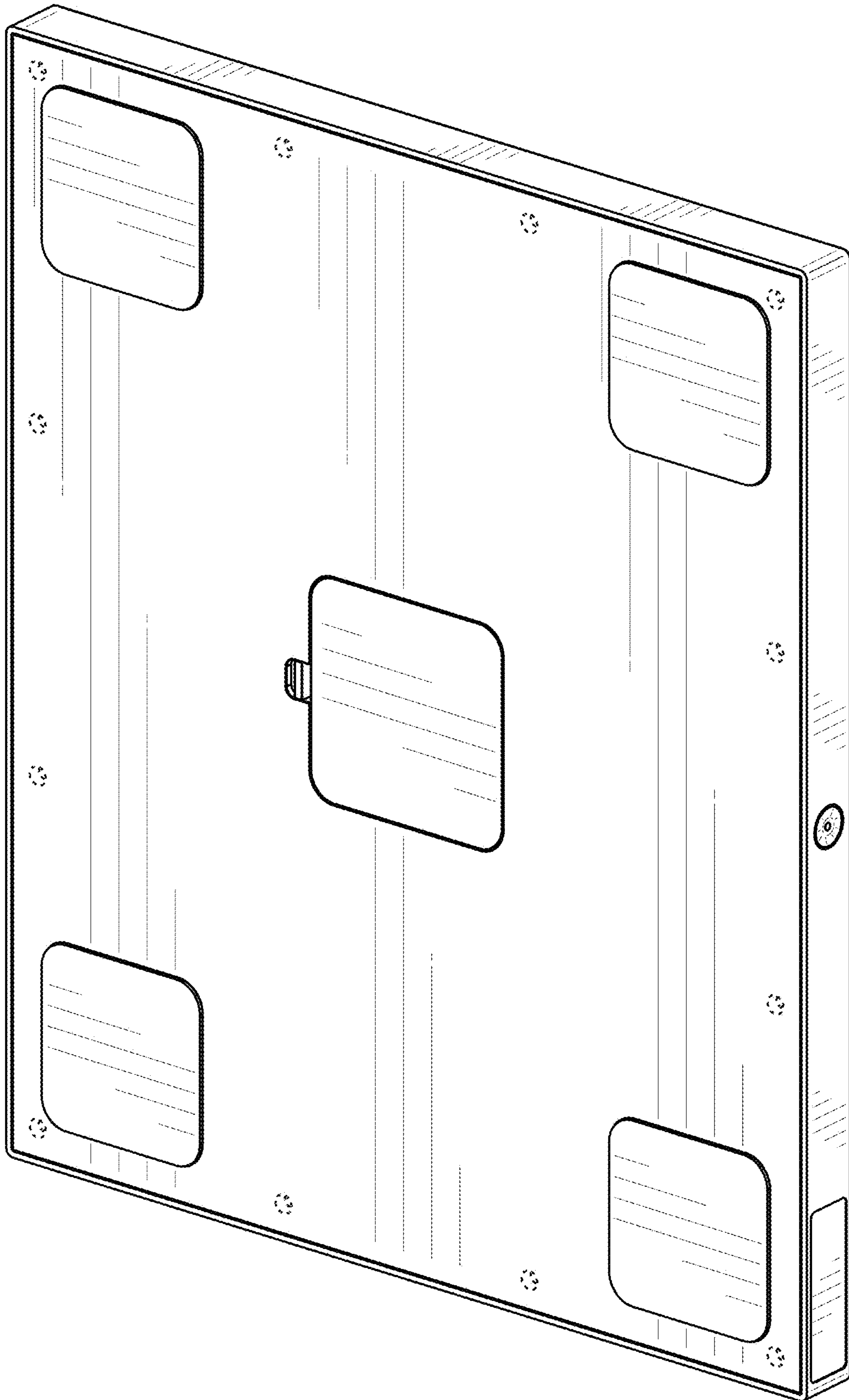

FIG. 10

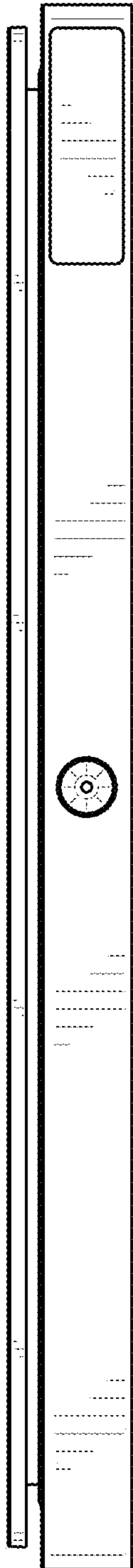

FIG. 11



FIG. 12

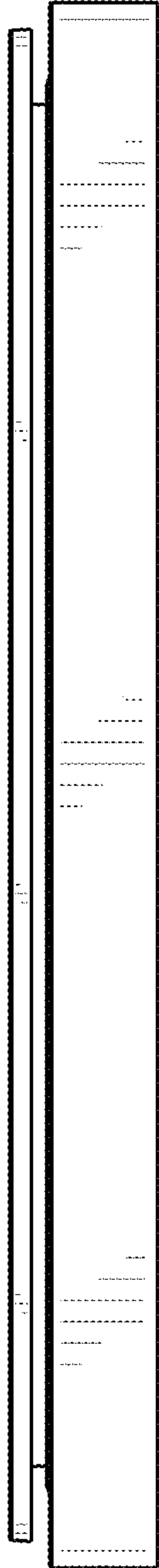

FIG. 13

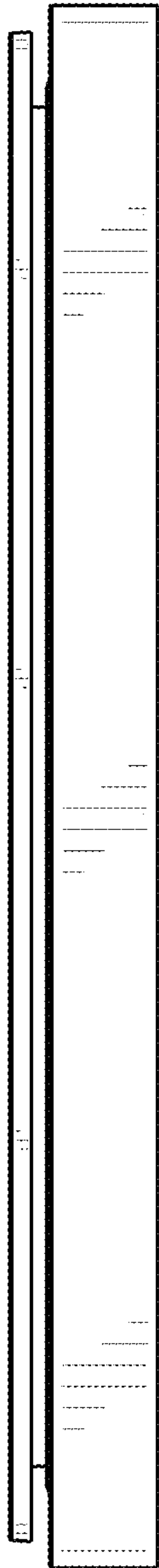

FIG. 14

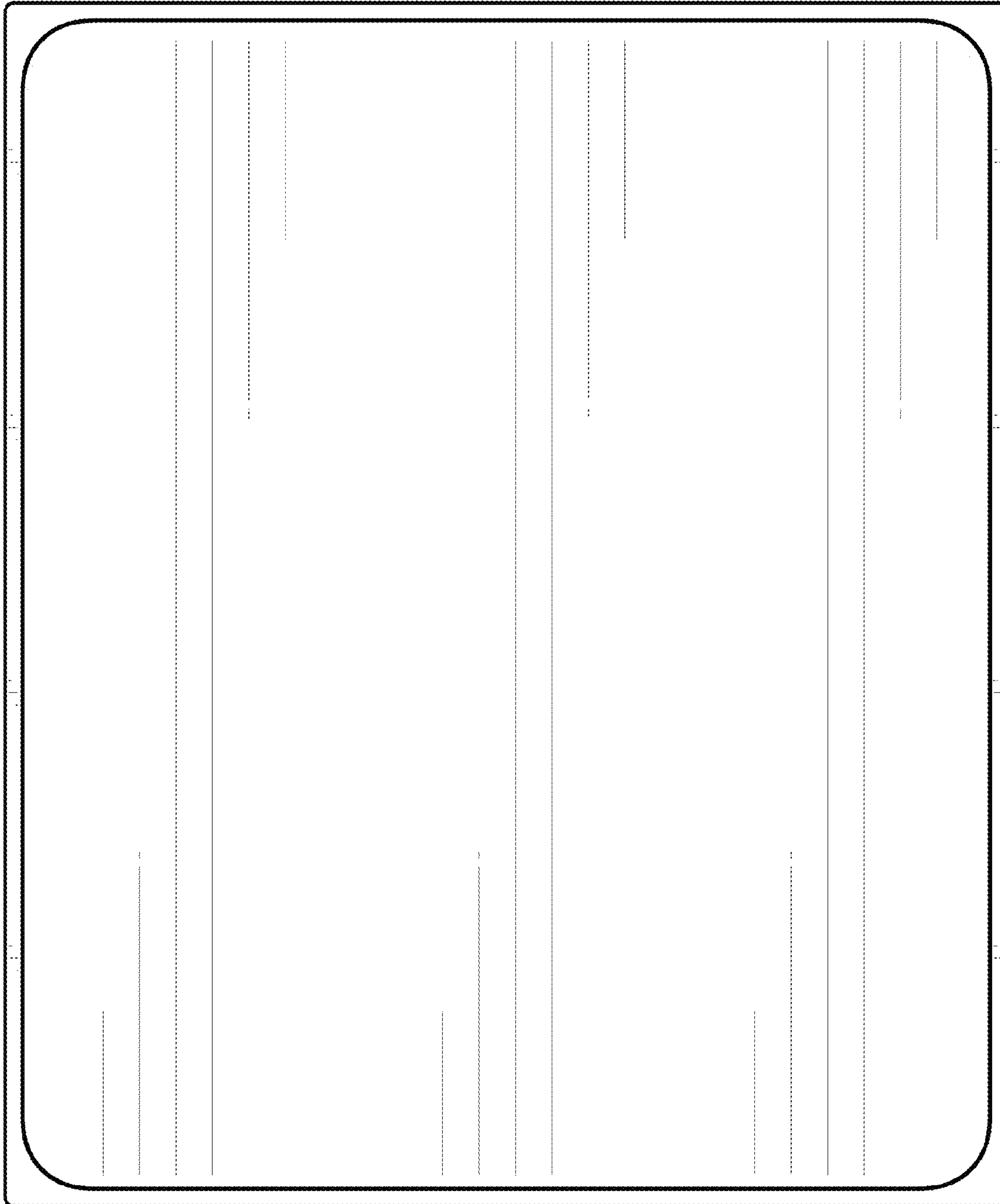

FIG. 15

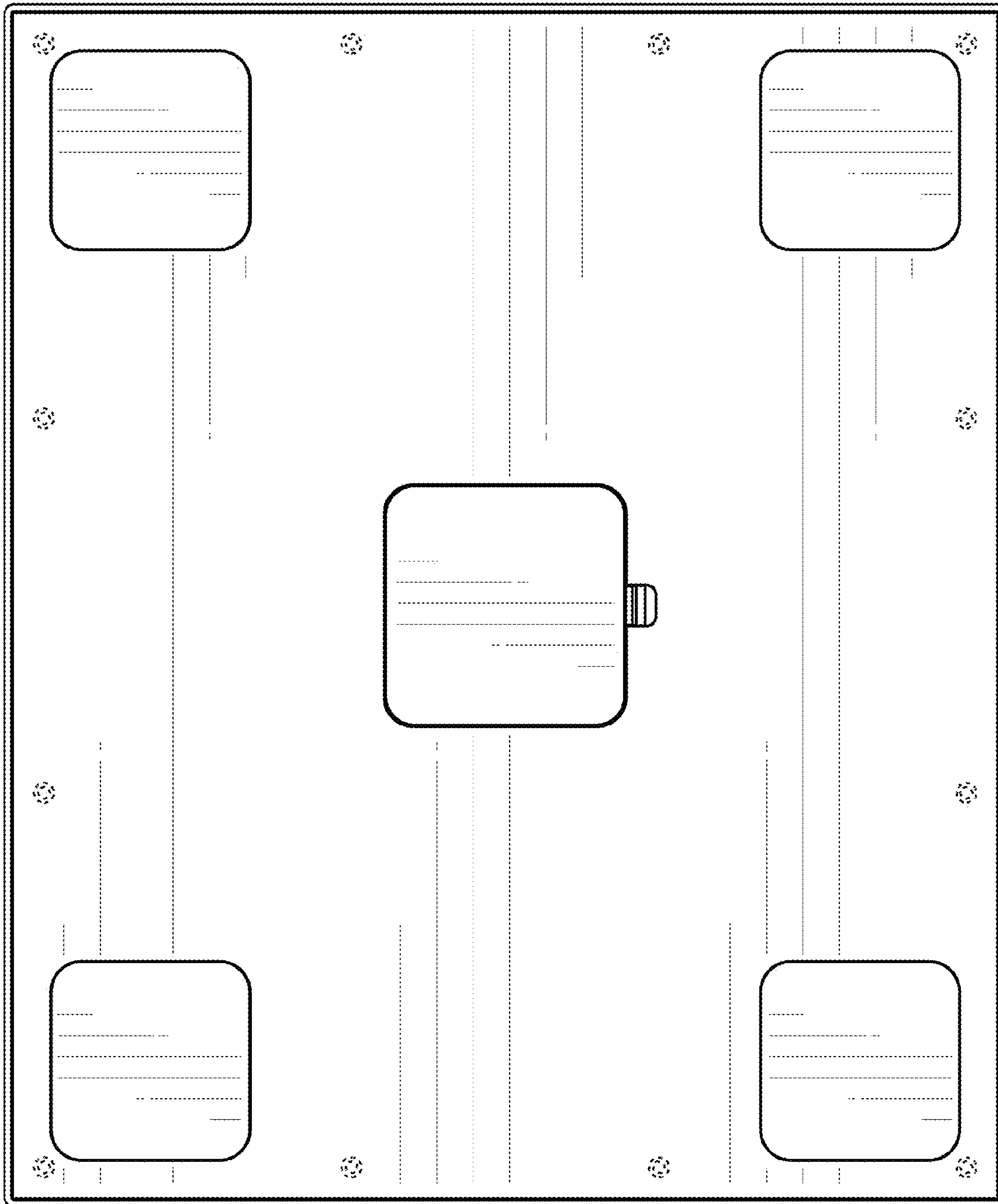

FIG. 16

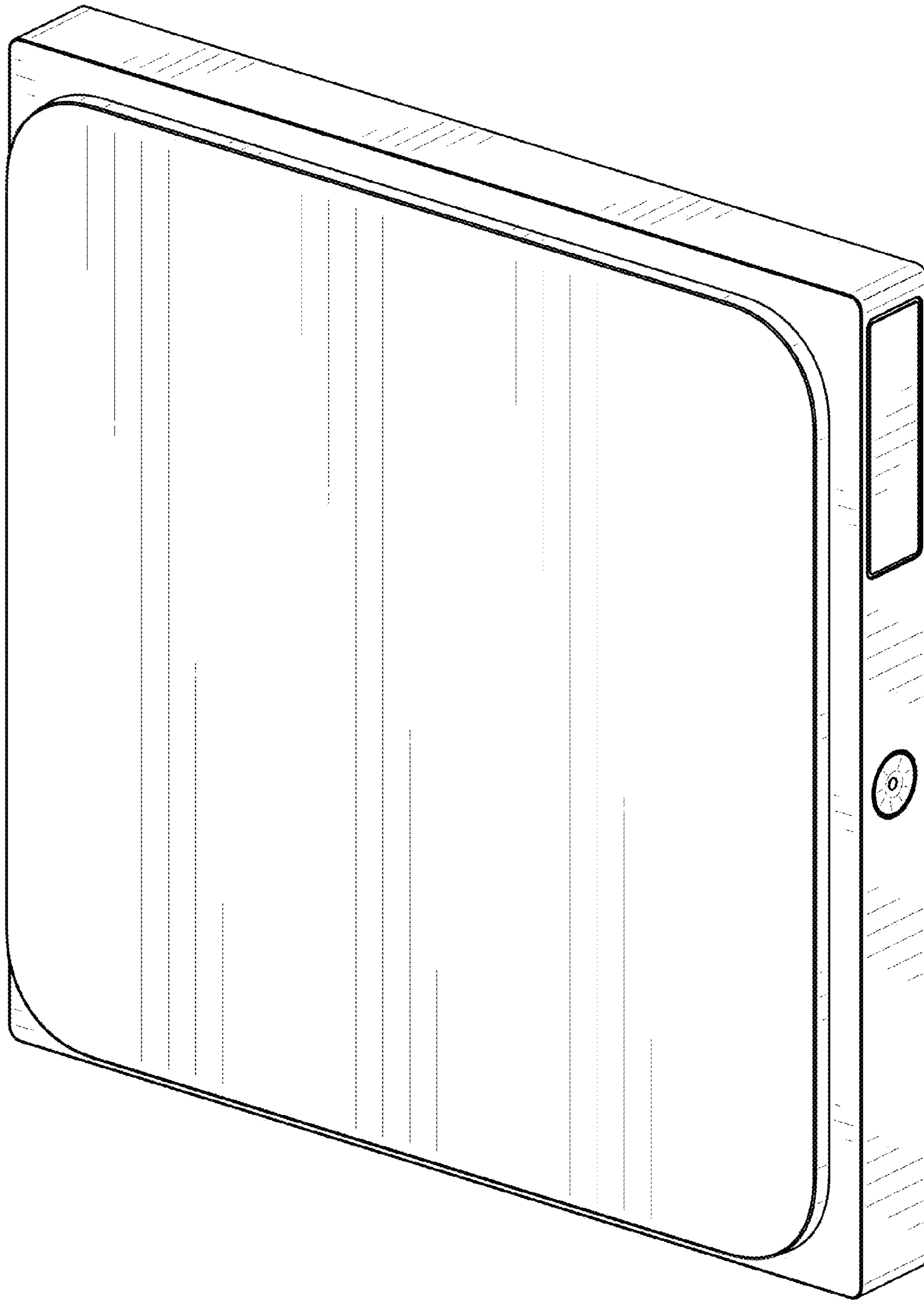

FIG. 17

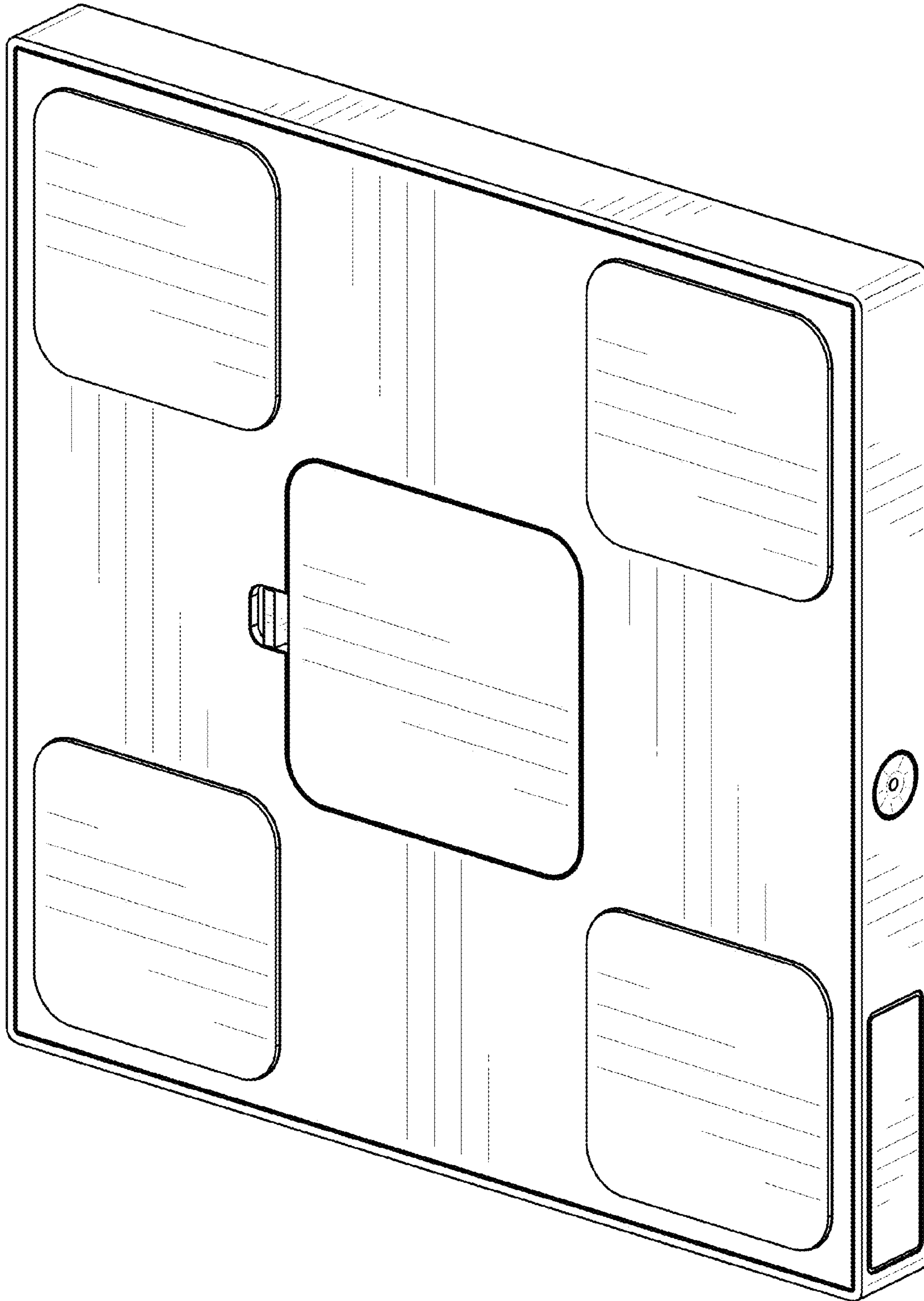

FIG. 18

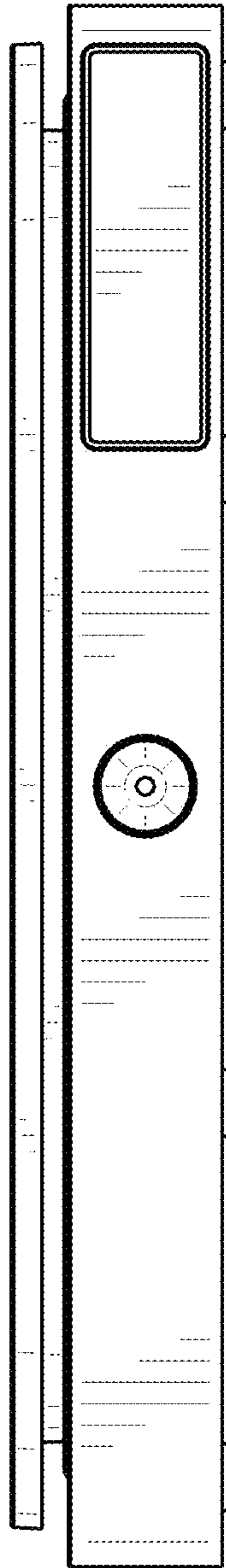

FIG. 19

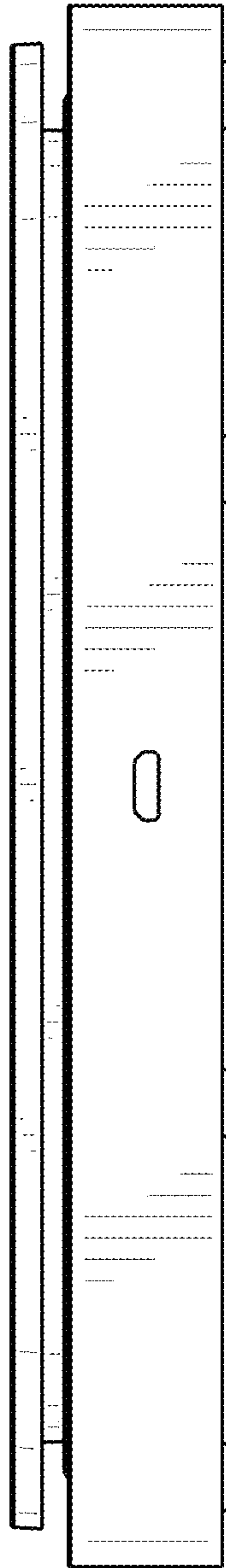

FIG. 20

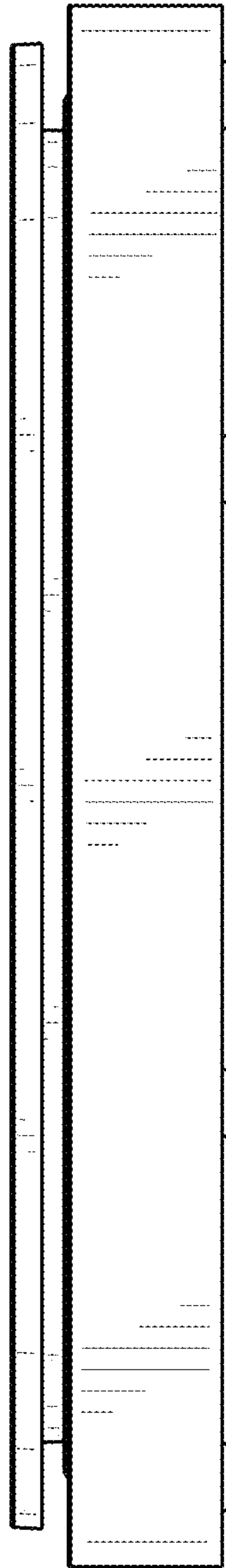

FIG. 21

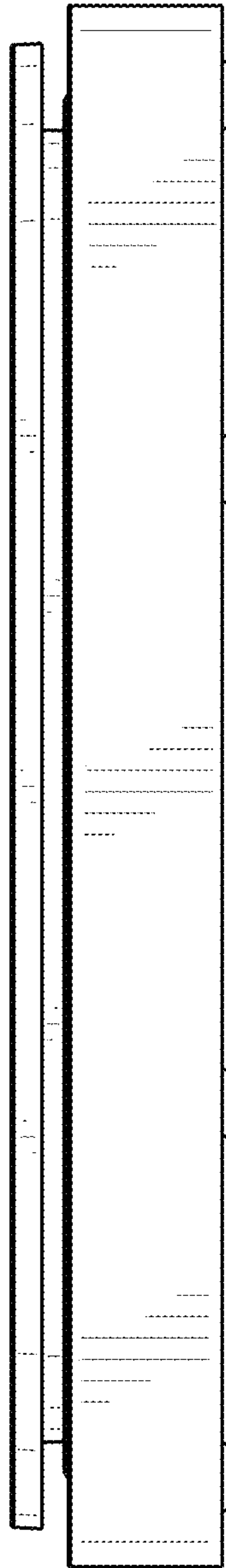

FIG. 22

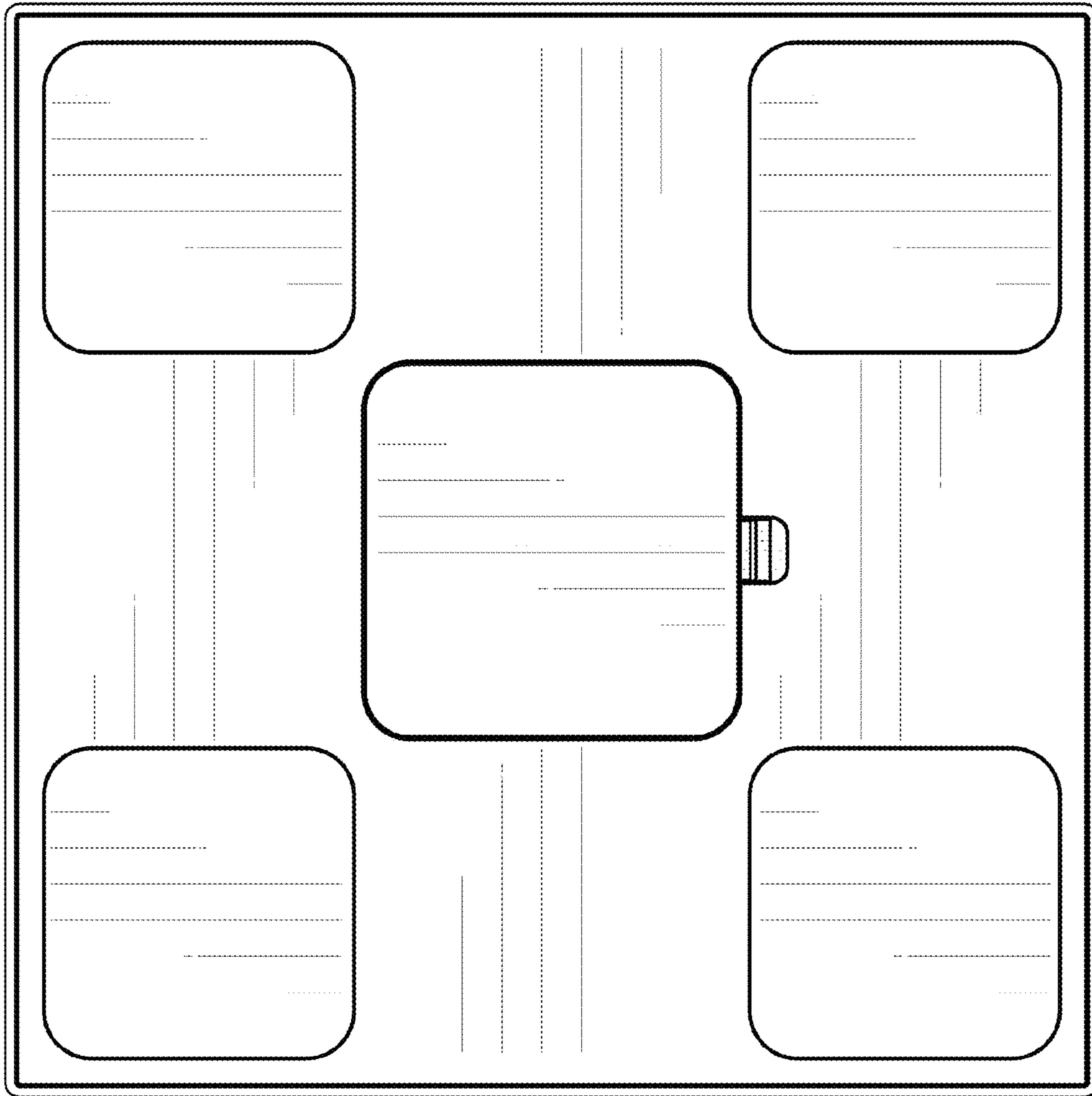

FIG. 24