



US00D938253S

(12) **United States Design Patent**  
**Chen**

(10) **Patent No.:** **US D938,253 S**

(45) **Date of Patent:** **\*\* Dec. 14, 2021**

(54) **HUNTING KNIFE**

(71) Applicant: **Sheng Chen**, Ningbo (CN)

(72) Inventor: **Sheng Chen**, Ningbo (CN)

(\*\*) Term: **15 Years**

(21) Appl. No.: **29/754,992**

(22) Filed: **Oct. 16, 2020**

(51) **LOC (13) Cl.** ..... **08-03**

(52) **U.S. Cl.**  
USPC ..... **D8/99**

(58) **Field of Classification Search**  
USPC ..... D8/98, 99, 100, 105, 107  
CPC ..... B26B 5/001; B26B 5/003; B26B 11/00;  
B26B 1/08; B26B 1/02; B26B 1/10;  
B26B 1/04; B26B 1/042; B26B 1/044;  
B26B 1/048; B26B 3/08; B26B 29/06;  
B26B 5/00

See application file for complete search history.

(56) **References Cited**

**U.S. PATENT DOCUMENTS**

D684,654 S	6/2013	Hunter	
D764,888 S *	8/2016	Bloch	D8/99
D767,079 S	9/2016	Hannan	
9,586,329 B2 *	3/2017	Schuft	B26B 5/001
D795,040 S *	8/2017	Bloch	D8/99
10,525,606 B2 *	1/2020	Cheng	B26B 1/044
D897,808 S *	10/2020	Gao	D8/99

D909,170 S *	2/2021	Bloch	D8/99
D926,551 S *	8/2021	Bloch	D8/99
2014/0366387 A1 *	12/2014	Schuft	B26B 29/04 30/293
2016/0271809 A1 *	9/2016	Bloch	B26B 5/00
2019/0217489 A1 *	7/2019	Cheng	B26B 1/044

**OTHER PUBLICATIONS**

The Ultimate Replaceable blade knife Test, Freerangeamerican.com, Mar. 21, 2021.\*

\* cited by examiner

*Primary Examiner* — Philip S Hyder

(57) **CLAIM**

The ornamental design for a hunting knife, as shown and described.

**DESCRIPTION**

FIG. 1 is a perspective view of a hunting knife showing my new design;  
FIG. 2 is another perspective view thereof;  
FIG. 3 is a front elevational view thereof;  
FIG. 4 is a rear elevational view thereof;  
FIG. 5 is a left side elevational view thereof;  
FIG. 6 is a right side elevational view thereof;  
FIG. 7 is a top plan view thereof; and,  
FIG. 8 is a bottom plan view thereof.  
The broken lines in the drawings depict portions of the hunting knife that form no part of the claimed design.

**1 Claim, 8 Drawing Sheets**

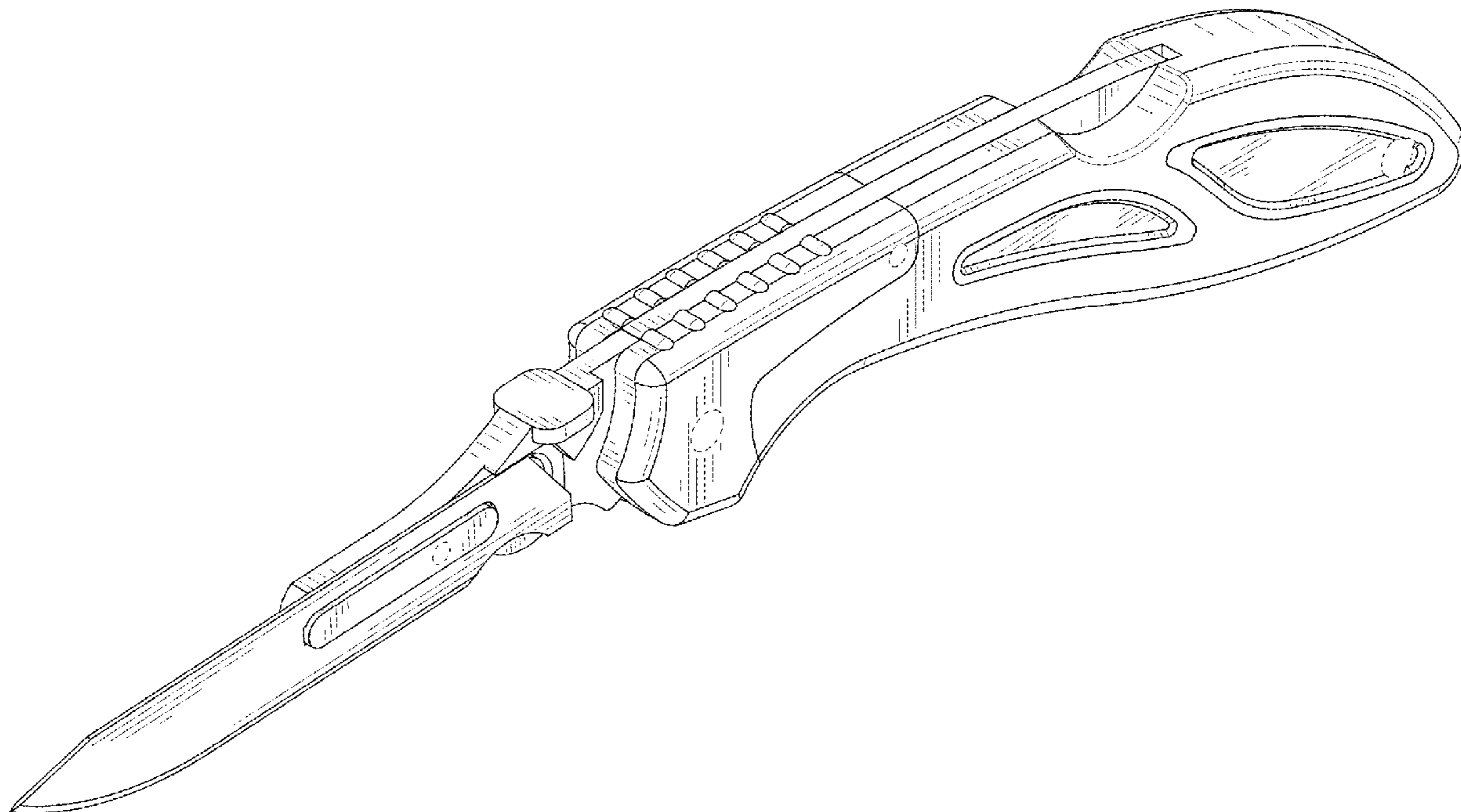

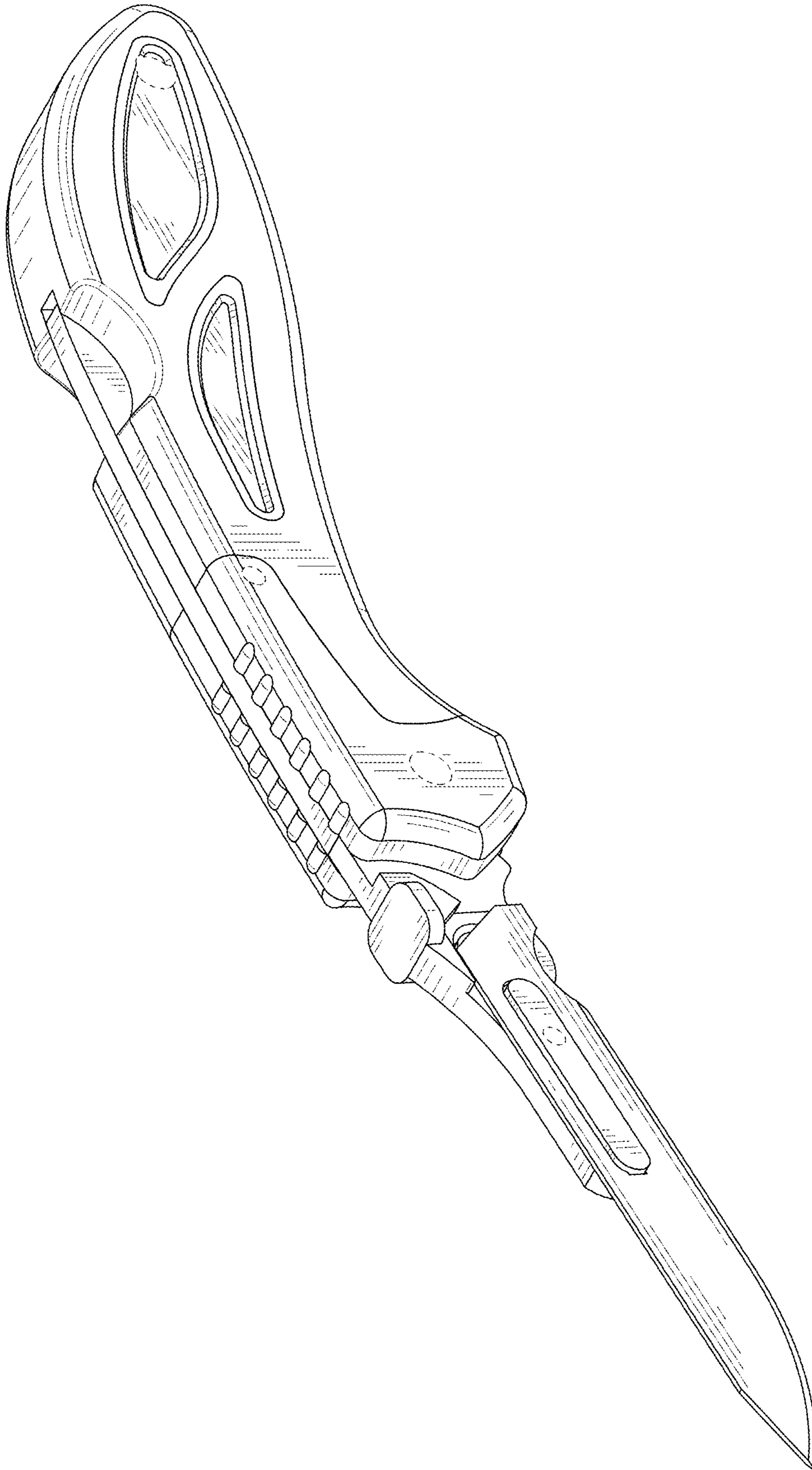

FIG. 1

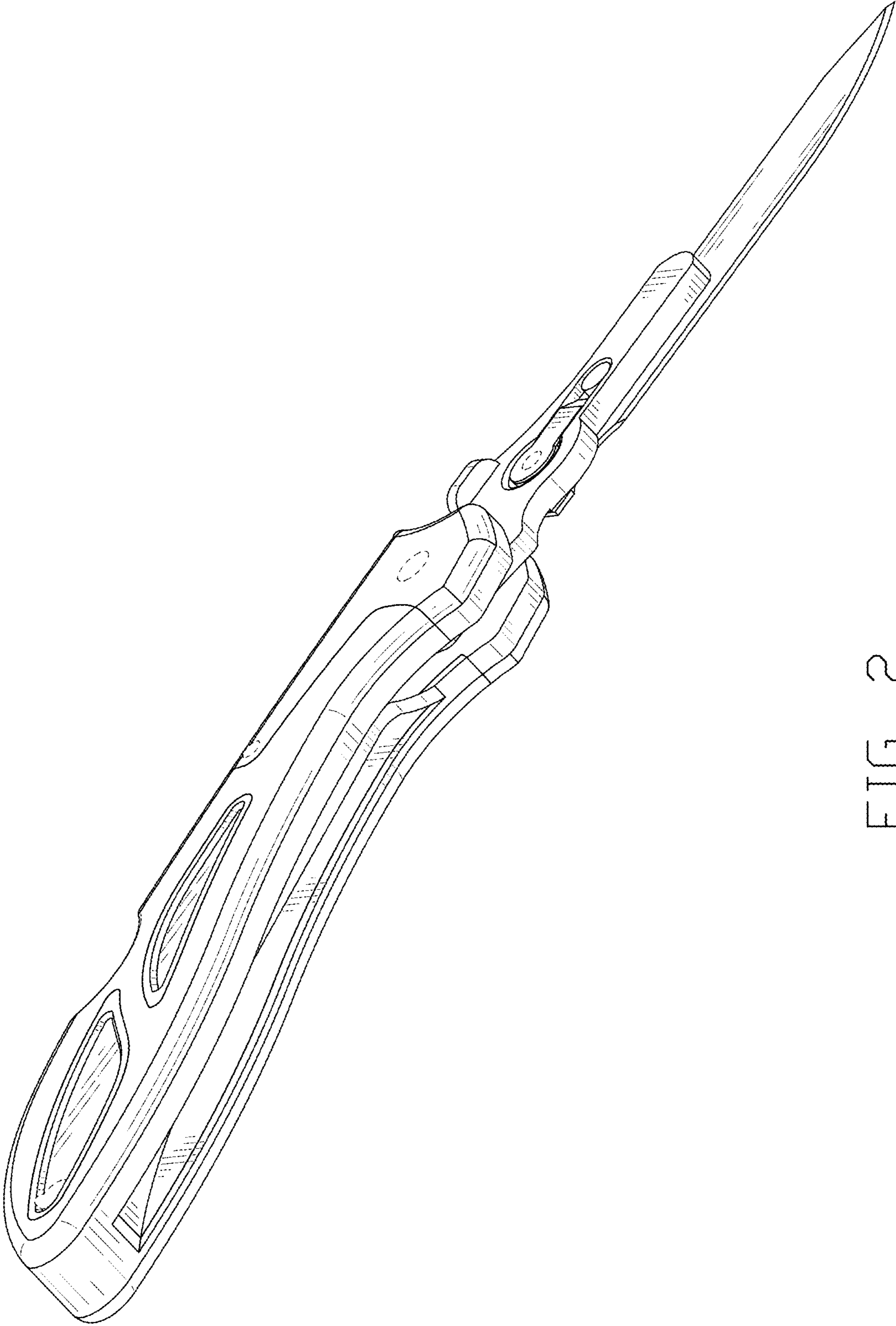

FIG. 2

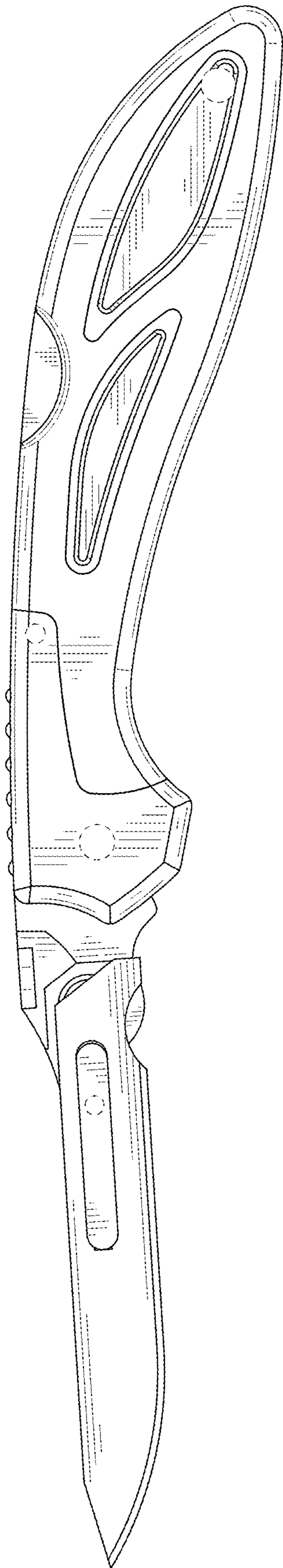

FIG. 3

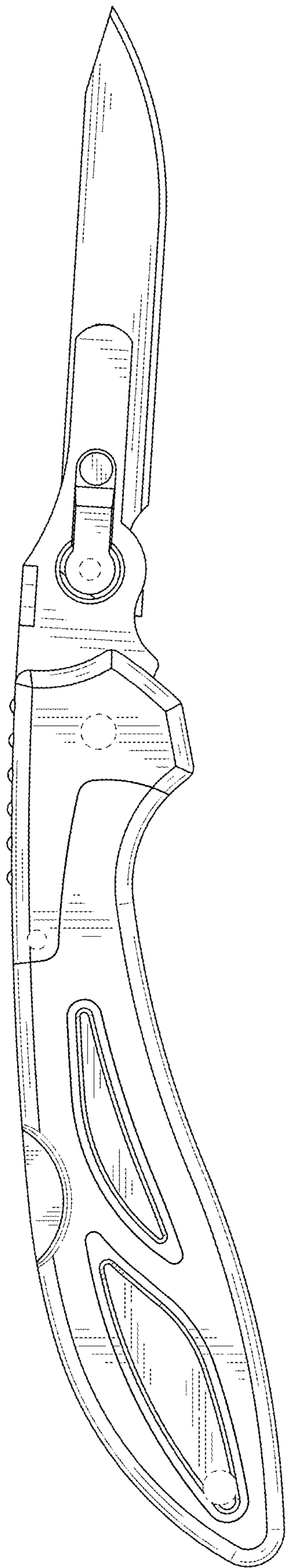

FIG. 4

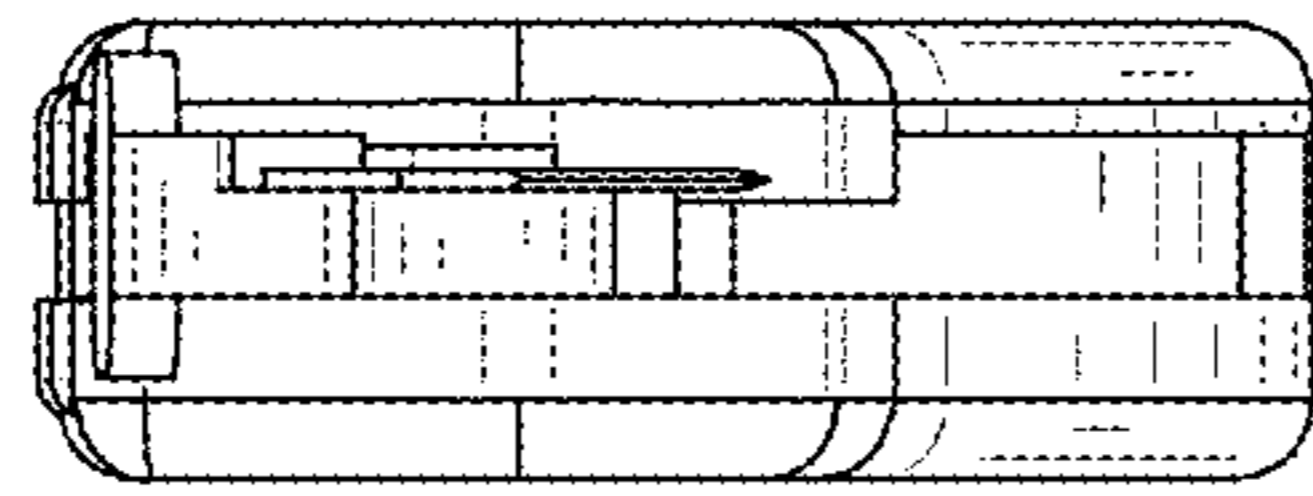

FIG. 5

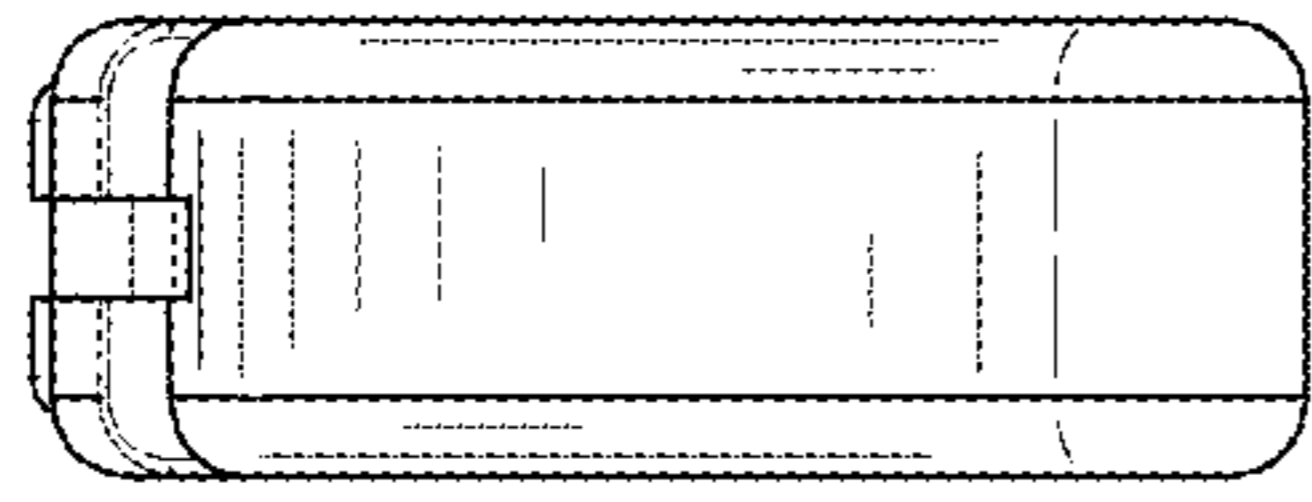

FIG. 6

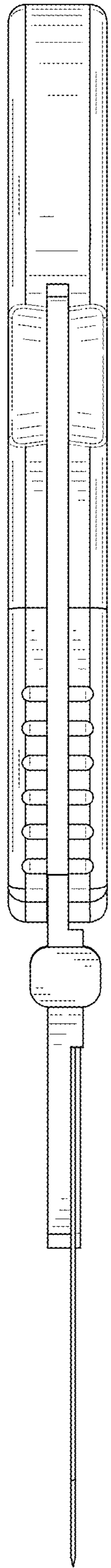

FIG. 7



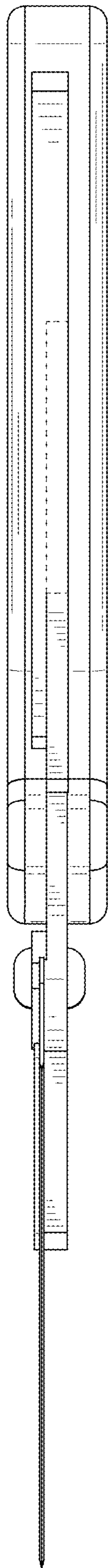

FIG. 8