



US00D938240S

(12) **United States Design Patent** (10) **Patent No.:** **US D938,240 S**
Lyytikäinen et al. (45) **Date of Patent:** **** Dec. 14, 2021**

(54) **PRUNER**
(71) Applicant: **Fiskars Finland Oy Ab**, Helsinki (FI)
(72) Inventors: **Sami Lyytikäinen**, Helsinki (FI); **Kari Kunnas**, Helsinki (FI)
(73) Assignee: **FISKARS FINLAND OY AB**, Helsinki (FI)

D396,615 S 8/1998 Spear
D426,755 S * 6/2000 Wu D8/5
D457,040 S 5/2002 Hirschfeld
D458,094 S 6/2002 Clivio
D458,815 S * 6/2002 Meyerratken D8/5
D458,816 S * 6/2002 Meyerratken D8/5
D463,227 S * 9/2002 Choi D8/5
D472,433 S * 4/2003 Richwine D8/5

(Continued)

(**) Term: **15 Years**
(21) Appl. No.: **29/715,365**
(22) Filed: **Dec. 2, 2019**

OTHER PUBLICATIONS

U.S. Appl. No. 29/710,921, filed Oct. 28, 2019, Weber et al.

(Continued)

(30) **Foreign Application Priority Data**
Sep. 24, 2019 (EM) 006913117
(51) **LOC (13) Cl.** **08-03**
(52) **U.S. Cl.**
USPC **D8/5**
(58) **Field of Classification Search**
USPC D8/4, 5, 7, 51, 52, 57
CPC A01G 2003/005; A01G 2003/023; A01G 2/35; A01G 3/02; A01G 3/065; A01G 3/021; B26B 13/26; B26B 13/28; B26B 13/285; B26B 13/16
See application file for complete search history.

Primary Examiner — Holly E Thurman
Assistant Examiner — Ieisha N Price
(74) *Attorney, Agent, or Firm* — Leason Ellis LLP

(57) **CLAIM**

The ornamental design for a pruner, as shown and described.

DESCRIPTION

FIG. 1 is a top plan view of our pruner according to our new design;
FIG. 2 is a left, side view thereof;
FIG. 3 is a right, side view thereof;
FIG. 4 is a bottom-left rear perspective view thereof;
FIG. 5 is a bottom-left front perspective view thereof;
FIG. 6 is a top-left rear perspective view thereof;
FIG. 7 is a top-left front perspective view thereof;
FIG. 8 is a front view thereof;
FIG. 9 is a bottom plan view thereof; and,
FIG. 10 is a rear view thereof.
The broken lines in the drawings illustrate portions of the pruner and form no part of the claimed design.
Conventional shading is illustrated for purposes of highlighting the line drawings, but forms no part of the claimed design.

(56) **References Cited**
U.S. PATENT DOCUMENTS
4,073,059 A 2/1978 Wallace et al.
4,079,513 A 3/1978 Harrison
4,268,963 A 5/1981 Harrison
4,341,016 A 7/1982 Harrison et al.
5,058,277 A * 10/1991 Kishimoto B26B 13/26
30/252
D336,412 S * 6/1993 Wensley D8/5
5,367,774 A 11/1994 Labarre et al.
5,426,857 A 6/1995 Linden
D377,588 S 1/1997 Birkholz

1 Claim, 10 Drawing Sheets

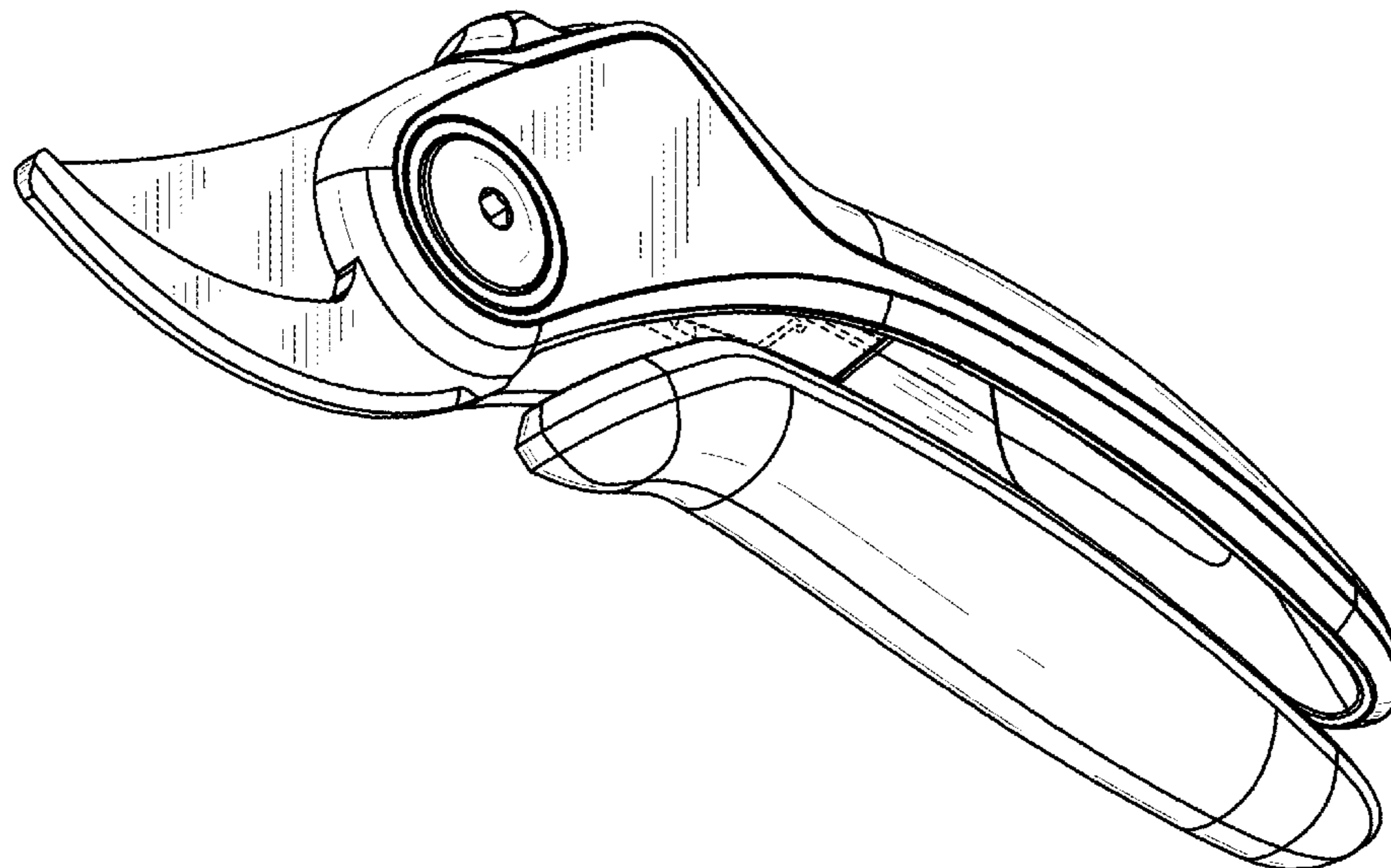

(56)

References Cited

U.S. PATENT DOCUMENTS

D496,838 S * 10/2004 Tomchak D8/5
 6,829,828 B1 12/2004 Cech et al.
 D501,379 S 2/2005 Lipscomb et al.
 D503,595 S 4/2005 Lipscomb et al.
 D506,906 S * 7/2005 Wu D8/5
 D509,115 S * 9/2005 Wu D8/5
 D547,140 S * 7/2007 Shan D8/5
 D557,086 S 12/2007 Lipscomb et al.
 D567,601 S 4/2008 Klecker
 D576,011 S 9/2008 Lipscomb et al.
 D585,250 S 1/2009 Lee
 D585,251 S * 1/2009 Lee D8/5
 D628,031 S 11/2010 Stokes et al.
 D628,032 S 11/2010 Stokes et al.
 7,895,757 B1 * 3/2011 Huang B26B 13/285
 30/250
 D651,053 S 12/2011 Roberts et al.
 D651,487 S 1/2012 Roberts et al.
 D680,829 S * 4/2013 Nelson D8/5
 D698,214 S * 1/2014 Sade D8/5
 D706,096 S 6/2014 Stokes et al.
 D706,097 S * 6/2014 Lyytikainen D8/5
 D706,590 S 6/2014 Sade et al.
 D716,114 S 10/2014 Lyytikainen et al.
 D720,968 S * 1/2015 Roberts D8/5
 D750,455 S * 3/2016 Wu D8/5
 9,408,350 B1 * 8/2016 Wu A01G 3/021
 D778,694 S 2/2017 Lambin
 D790,935 S * 7/2017 Wu D8/5
 D793,824 S 8/2017 Sokka
 D802,381 S 11/2017 Wolf

D810,524 S 2/2018 Hsu
 D815,501 S * 4/2018 Huang D8/5
 D818,783 S 5/2018 Wermeille
 D823,079 S * 7/2018 Lyytikainen D8/4
 D827,399 S * 9/2018 Lyytikainen D8/5
 D829,516 S 10/2018 Wu-Shih-Piao
 D859,100 S 9/2019 Wu-Shih-Piao
 D875,483 S 2/2020 Roberts et al.
 2009/0090010 A1 4/2009 Lin
 2009/0151170 A1 6/2009 Lee
 2010/0037470 A1 2/2010 Liu
 2011/0023309 A1 * 2/2011 Huang B26B 13/16
 30/234
 2011/0192035 A1 * 8/2011 Chen A01G 3/02
 30/251
 2012/0198705 A1 8/2012 Huang
 2013/0091713 A1 4/2013 Wu
 2014/0182142 A1 * 7/2014 Vanttila B26B 13/18
 30/271
 2014/0202007 A1 7/2014 Huang
 2016/0183475 A1 * 6/2016 Wu A01G 3/021
 30/250
 2017/0049060 A1 2/2017 Chou
 2017/0215346 A1 8/2017 Lin
 2019/0261573 A1 8/2019 Wu-Shih-Piao

OTHER PUBLICATIONS

U.S. Appl. No. 29/710,923, filed Oct. 28, 2019, Roberts et al.
 U.S. Appl. No. 29/710,926, filed Oct. 28, 2019, Roberts et al.
 U.S. Appl. No. 29/710,931, filed Oct. 28, 2019, Roberts et al.
 U.S. Appl. No. 29/710,935, filed Oct. 28, 2019, Roberts et al.

* cited by examiner

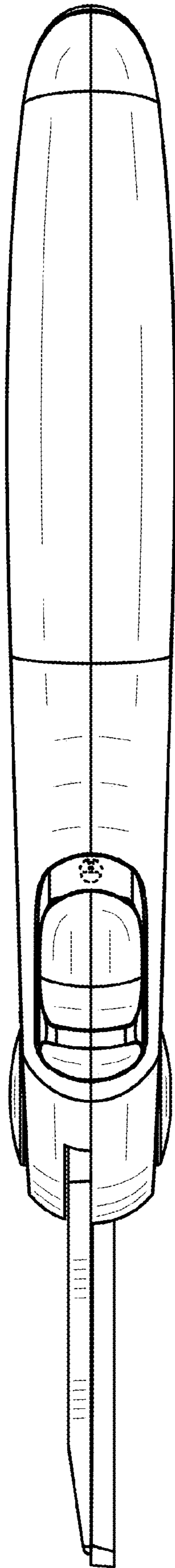

FIG. 1

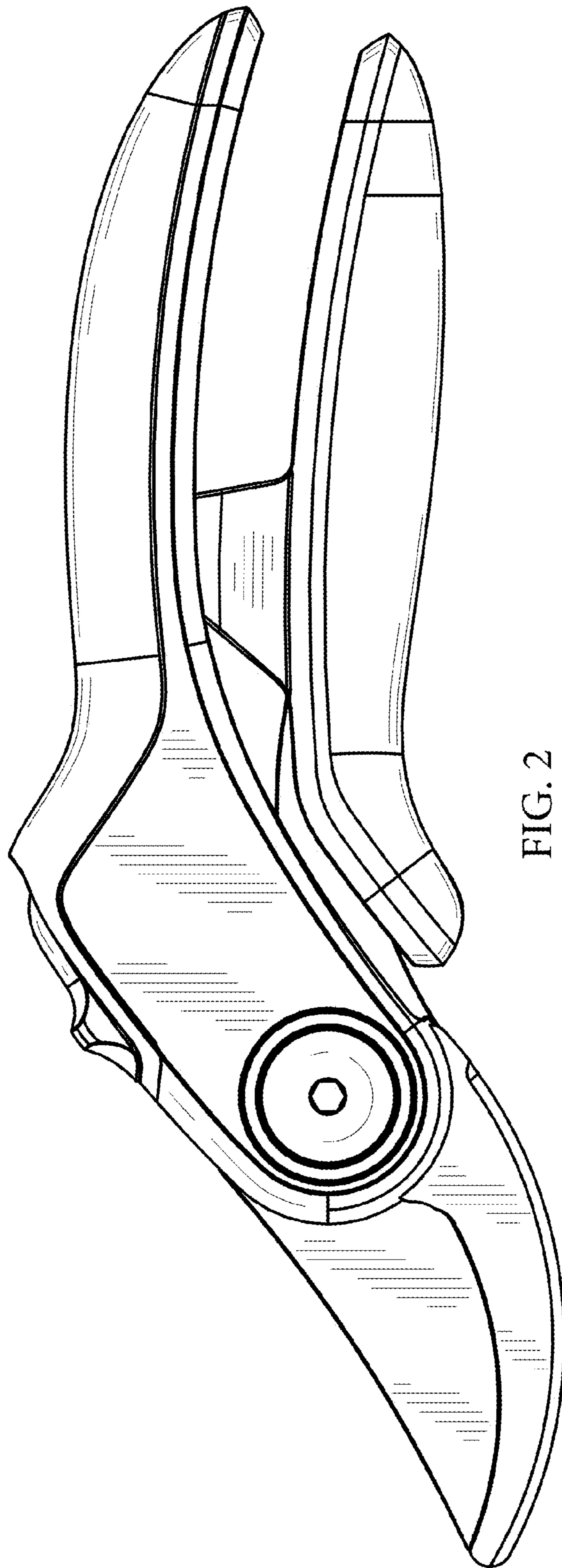

FIG. 2

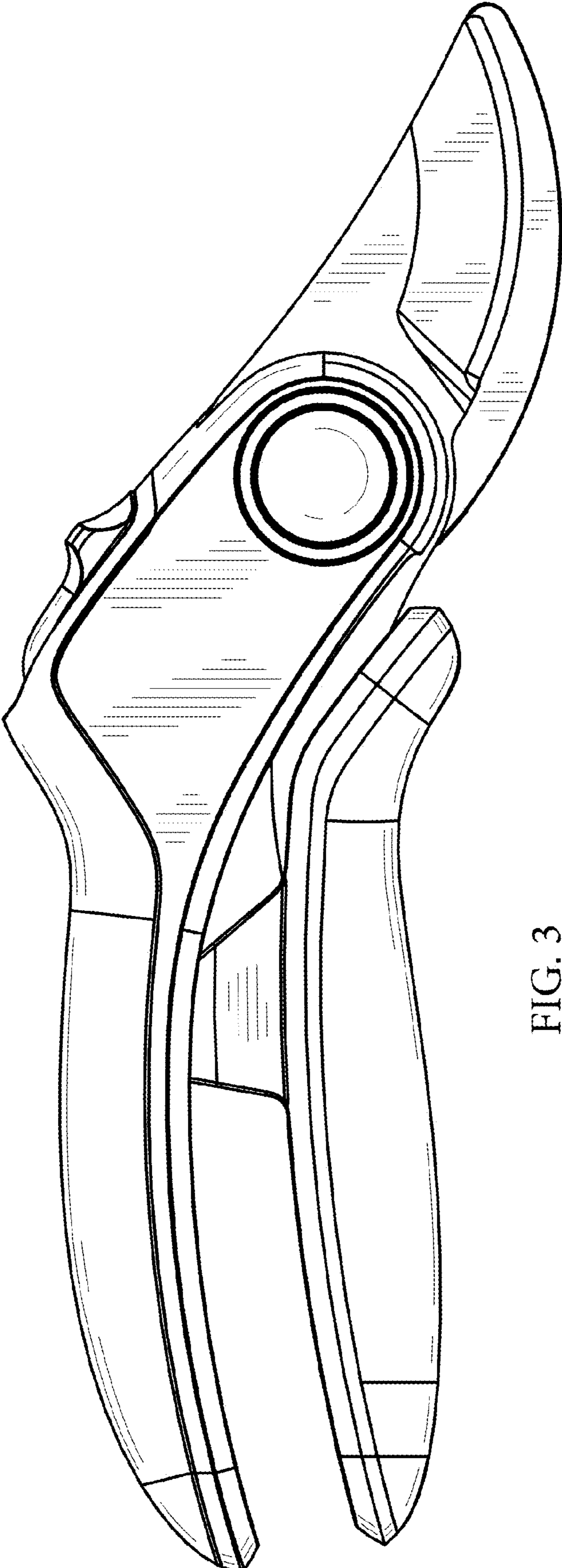

FIG. 3

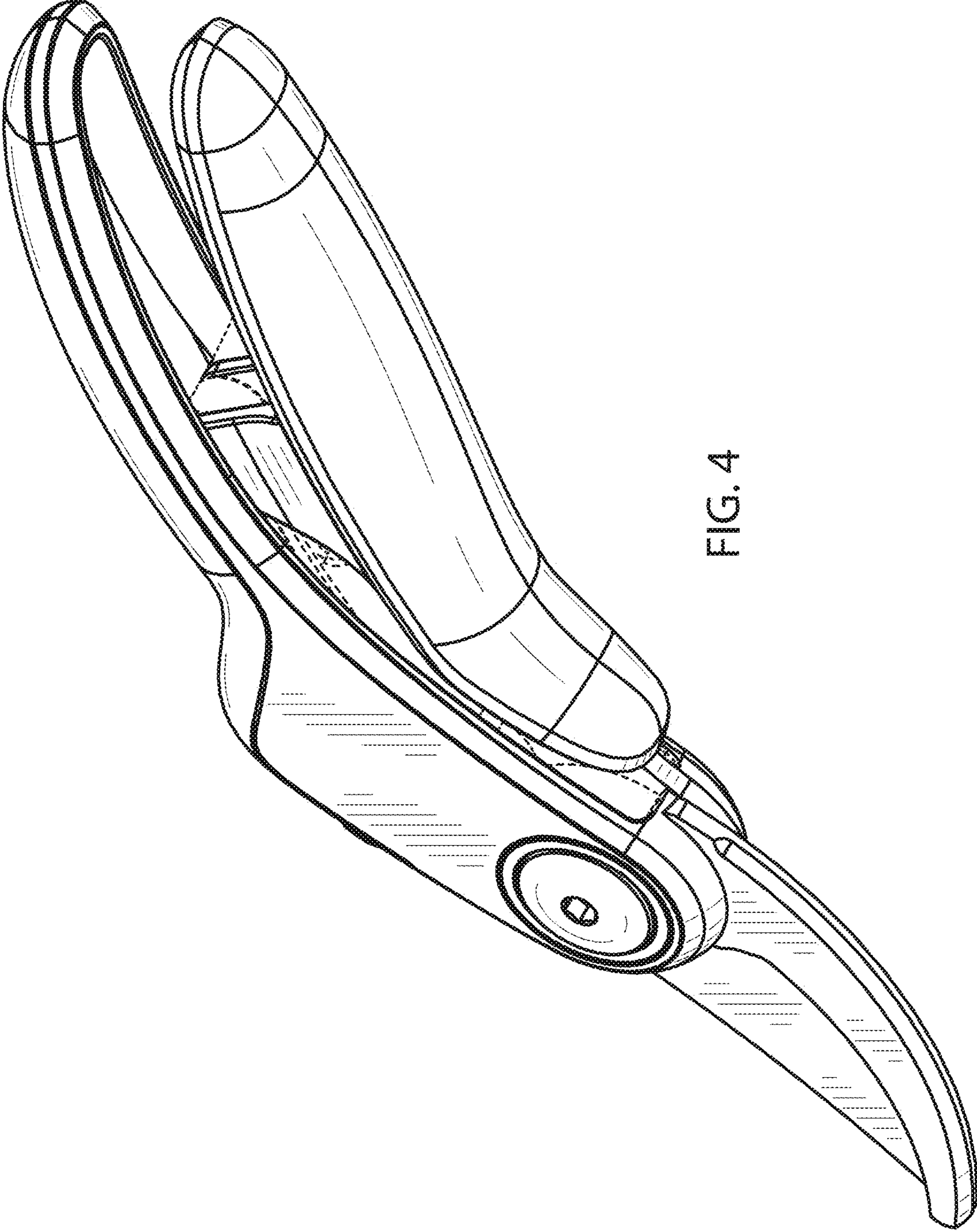

FIG. 4

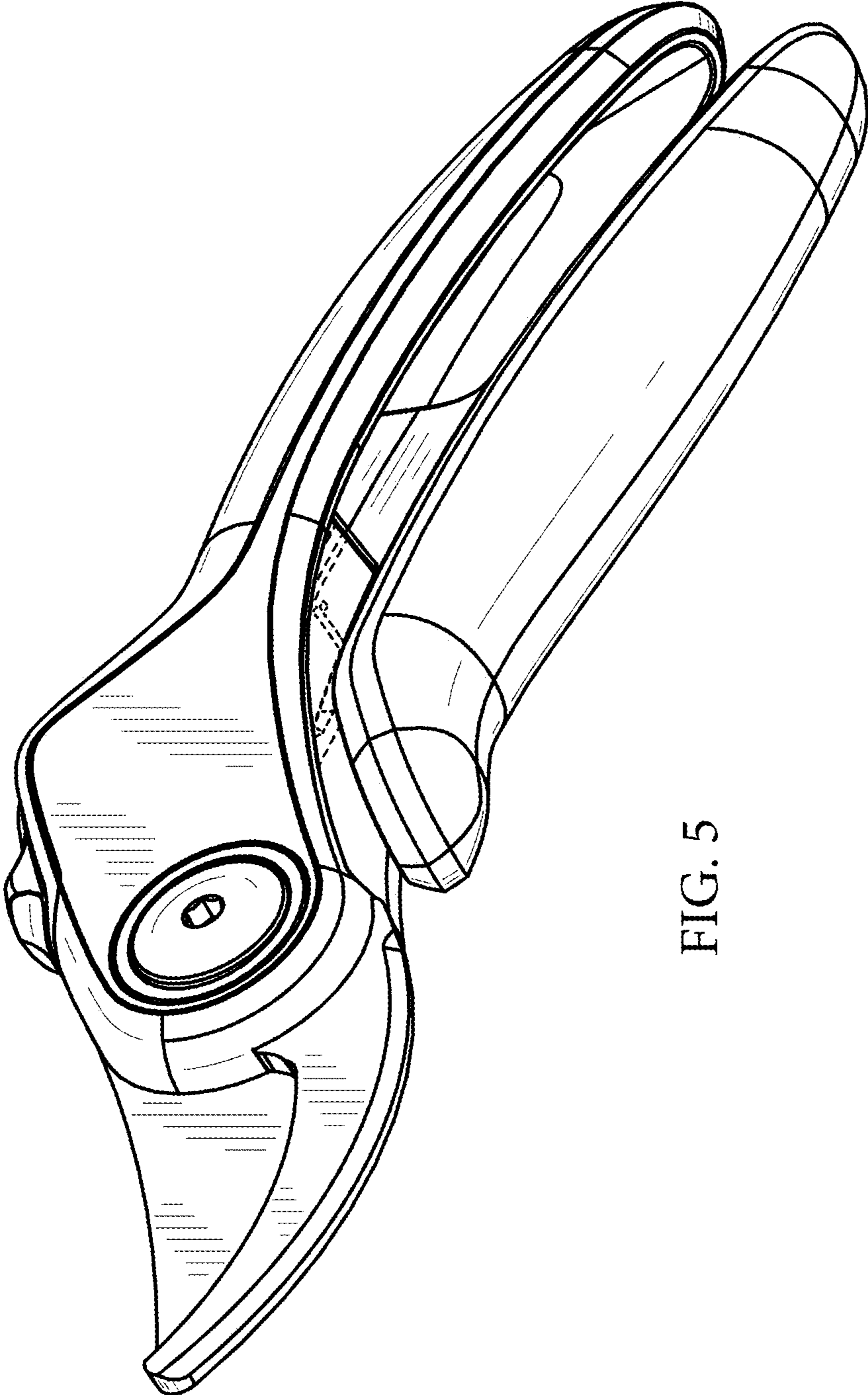

FIG. 5

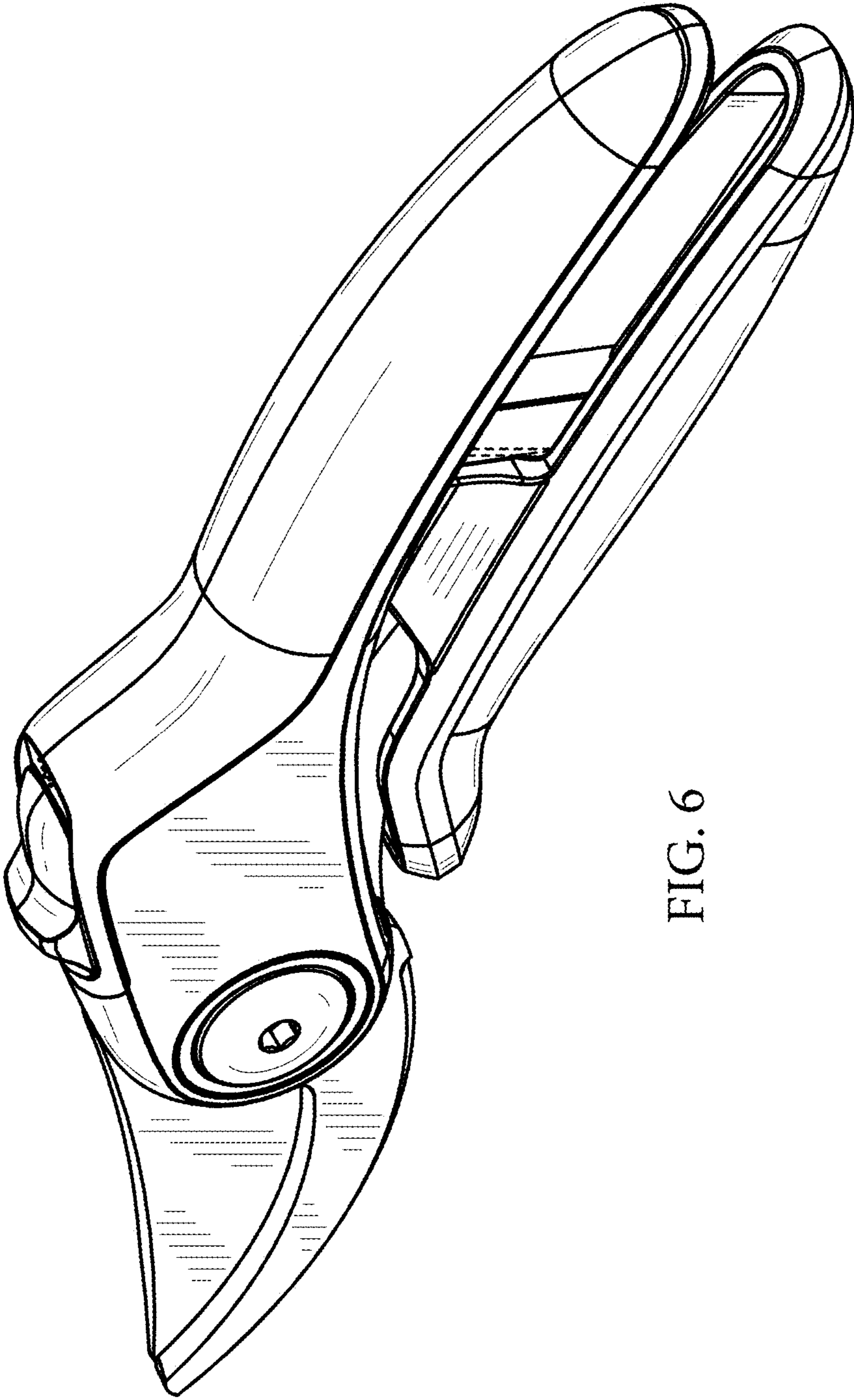

FIG. 6

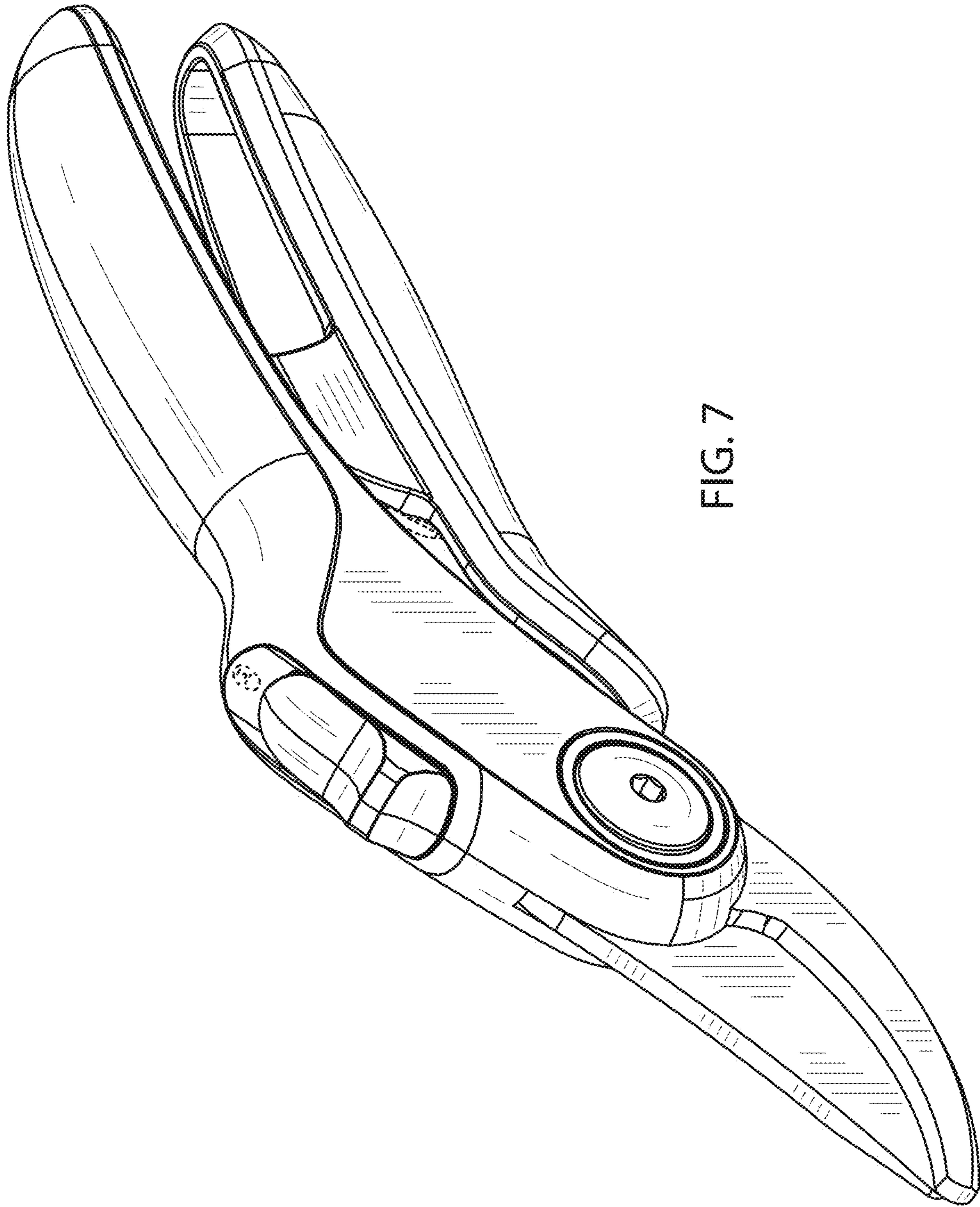

FIG. 7

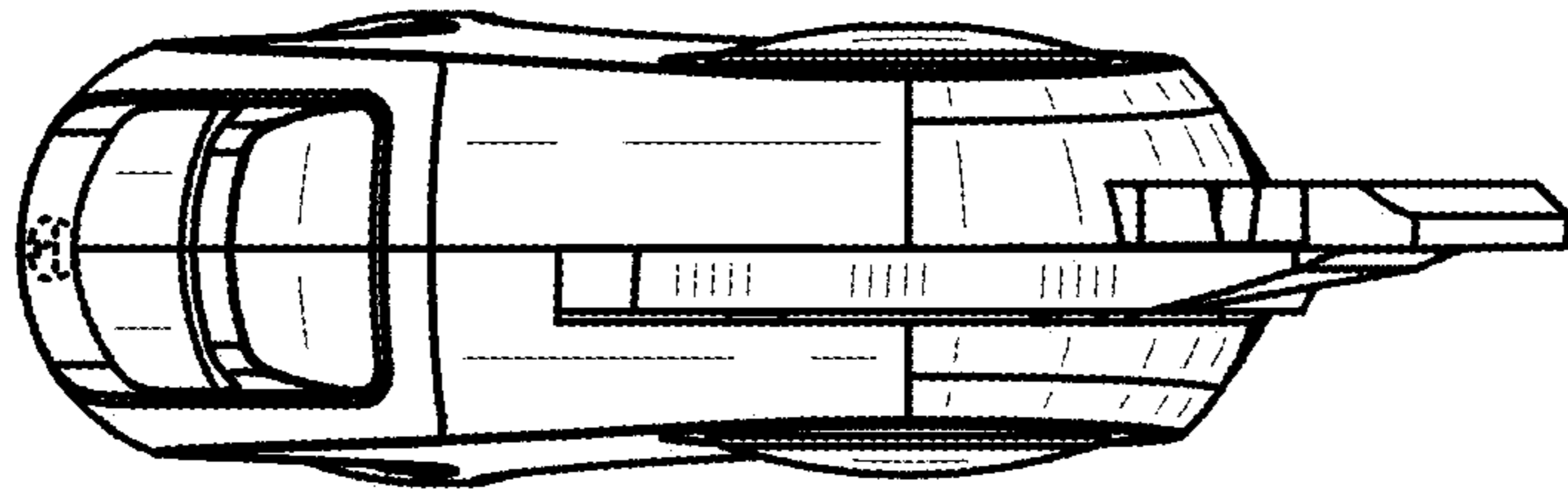

FIG. 8

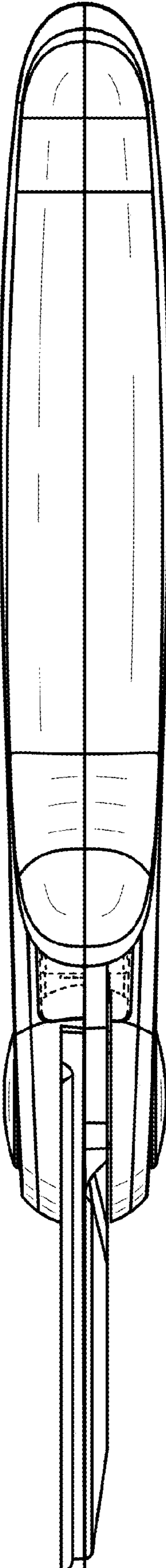

FIG. 9

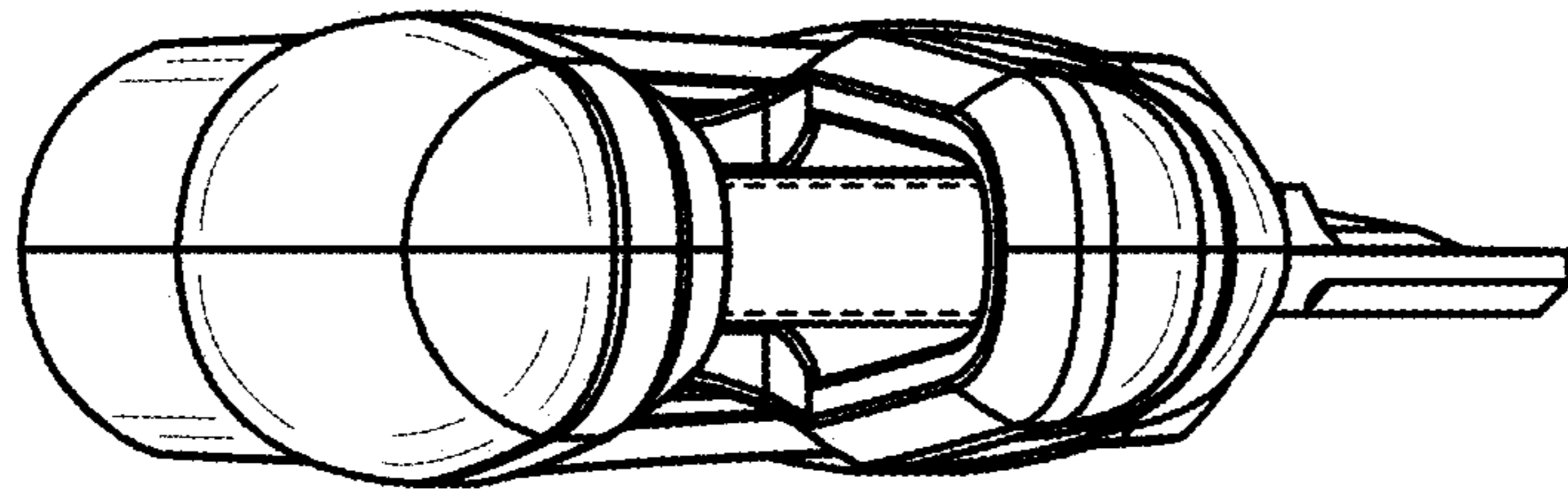

FIG. 10