



US00D938205S

(12) **United States Design Patent**
Baer et al.

(10) **Patent No.:** **US D938,205 S**

(45) **Date of Patent:** **** Dec. 14, 2021**

- (54) **RETAIL DISPLAY KIT**
- (71) Applicant: **ZenGenius, Inc.**, Columbus, OH (US)
- (72) Inventors: **Joseph Baer**, Columbus, OH (US);
Paul Cook, Columbus, OH (US); **Jalpa Patel**, Columbus, OH (US); **Meghan Lefeld**, Columbus, OH (US)
- (73) Assignee: **ZENGENIUS, INC.**, Columbus, OH (US)
- (**) Term: **15 Years**
- (21) Appl. No.: **29/737,770**
- (22) Filed: **Jun. 11, 2020**
- (51) **LOC (13) Cl.** **06-06**
- (52) **U.S. Cl.**
USPC **D6/682.2**
- (58) **Field of Classification Search**
USPC D6/672, 675, 682, 682.1, 682.2, 682.3,
D6/682.4, 512; D19/101, 107, 75, 77,
D19/81, 99, 100
CPC A47F 5/00; A47F 5/0018; A47F 5/0081;
A47F 5/0043; A47F 5/0093; A47F 5/16;
B44D 1/125; B43K 23/00; B43K 23/002
See application file for complete search history.

5,617,960 A *	4/1997	Bishop	A47B 97/02 211/44
D465,891 S *	11/2002	Brown	D32/55
D474,274 S *	5/2003	Walters	D24/128
D497,272 S *	10/2004	Schultz	D6/682.2
D504,550 S *	4/2005	Setcer, Jr.	D99/34
D506,833 S *	6/2005	Wescott, III	B01L 9/06 D24/230
D507,658 S *	7/2005	Wescott, III	B01L 9/06 422/412
D566,423 S *	4/2008	Raile	D6/682.2
D597,370 S *	8/2009	Watkins	D7/354
D621,639 S *	8/2010	Merrick	D6/682.2
D704,261 S *	5/2014	Kim	D19/85
D785,428 S *	5/2017	Friesen	D8/71
D925,304 S *	7/2021	Lukyanov	D7/701
2006/0039834 A1 *	2/2006	Itoh	B01L 9/06 422/400

* cited by examiner

Primary Examiner — Kelley A Donnelly

(74) *Attorney, Agent, or Firm* — Tyler S. Dunham, Esq.

(57) **CLAIM**

We claim, the ornamental design for a retail display kit, as shown and described above.

DESCRIPTION

FIG. 1 is a front perspective view of the retail display kit; FIG. 2 is a front elevation view of the retail display kit; FIG. 3 is a rear elevation view of the retail display kit; FIG. 4 is a left elevation view of the retail display kit; FIG. 5 is a rear elevation view of the retail display kit; FIG. 6 is a top plan view of the retail display kit; FIG. 7 is a bottom plan view of the retail display kit; and, FIG. 8 is a front perspective view of the retail display kit in an alternative arrangement for packing and shipping.

1 Claim, 8 Drawing Sheets

(56) **References Cited**
U.S. PATENT DOCUMENTS

769,592 A *	9/1904	Long	B43M 99/003 211/69.5
1,092,156 A *	4/1914	Mathis	A61L 2/00 206/207
2,459,921 A *	1/1949	Comer	B65D 71/0003 220/512
3,593,856 A *	7/1971	Zander	A45C 11/34 211/69.5
D265,126 S *	6/1982	Beall	D24/230

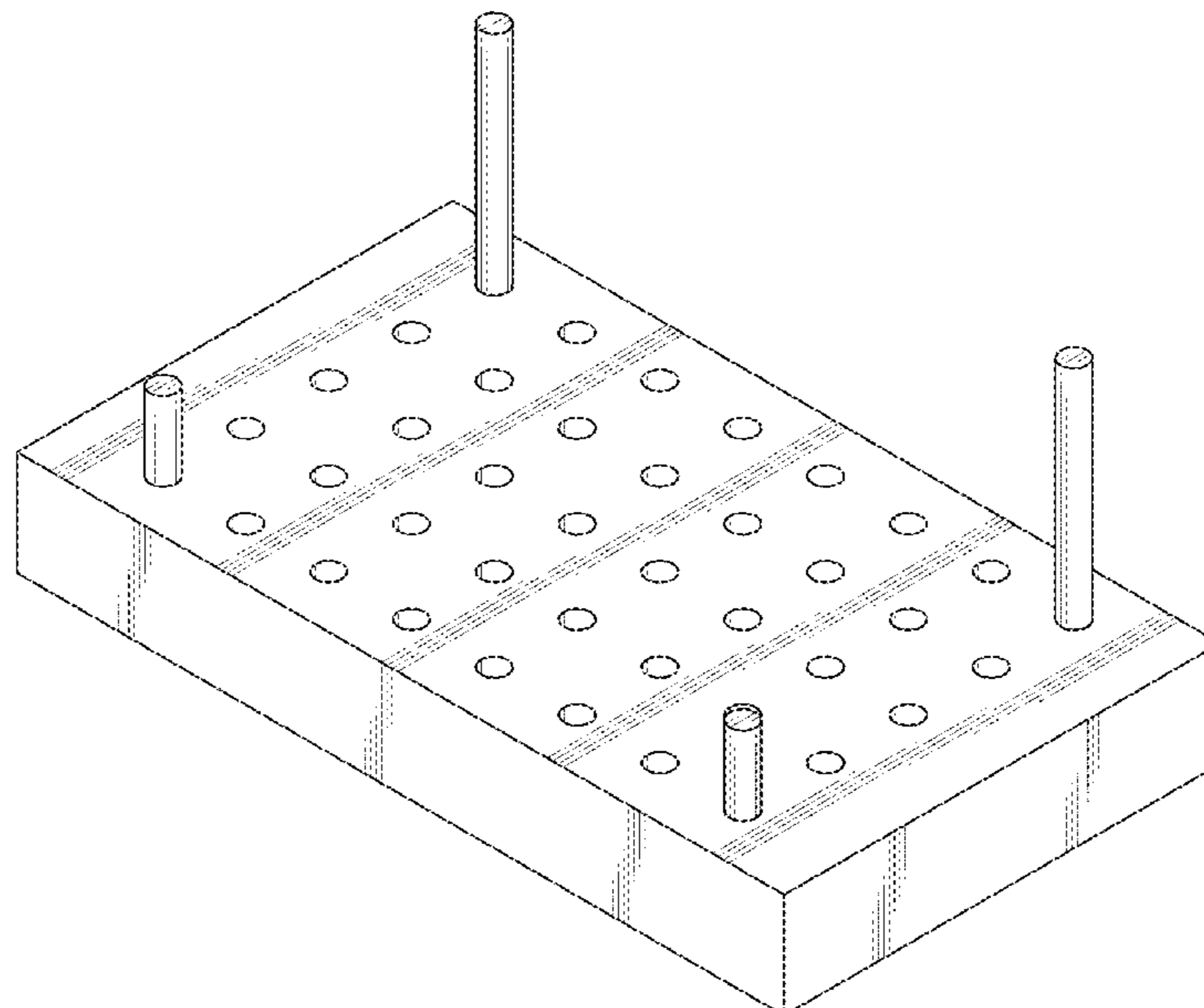

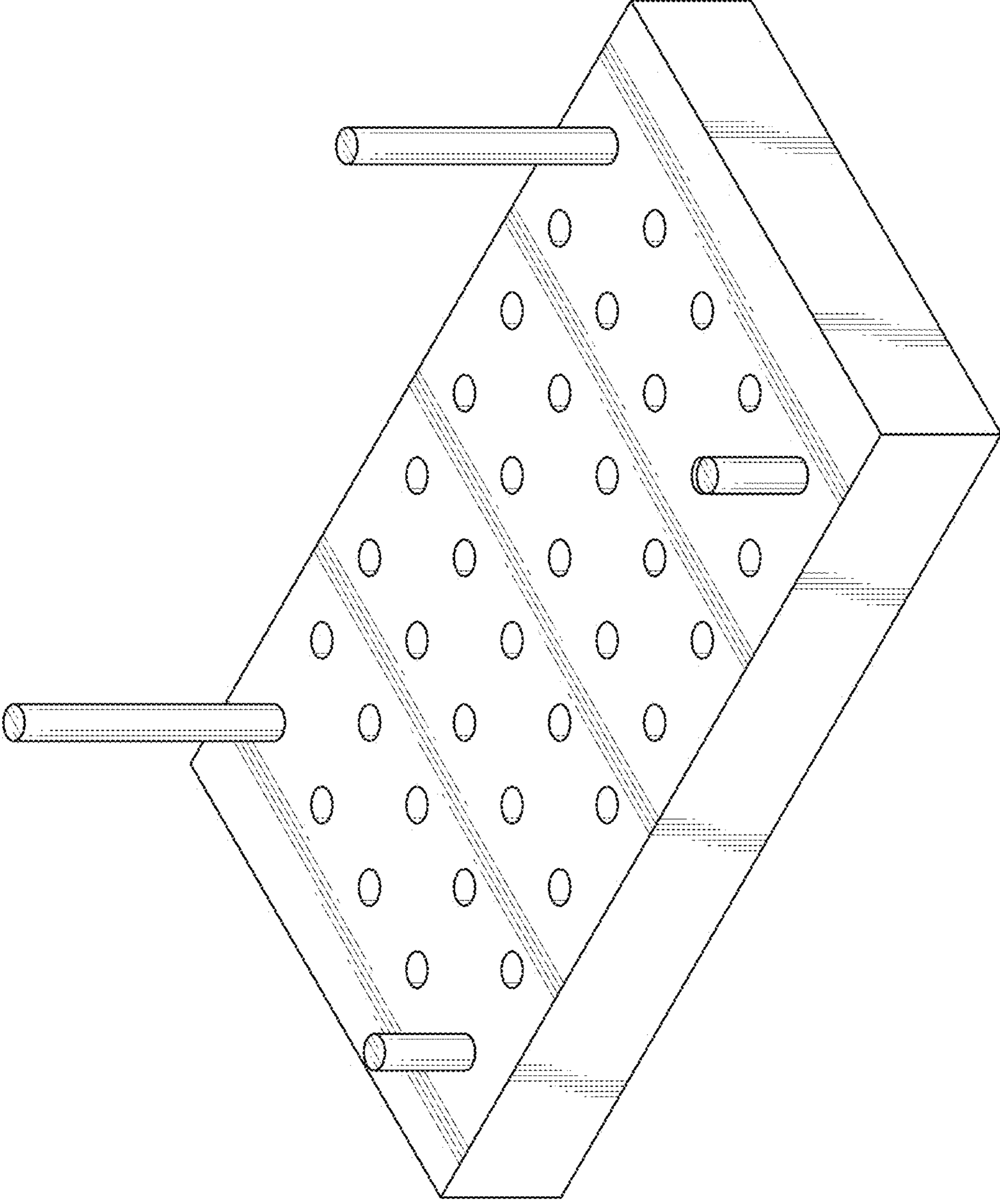

FIG. 1

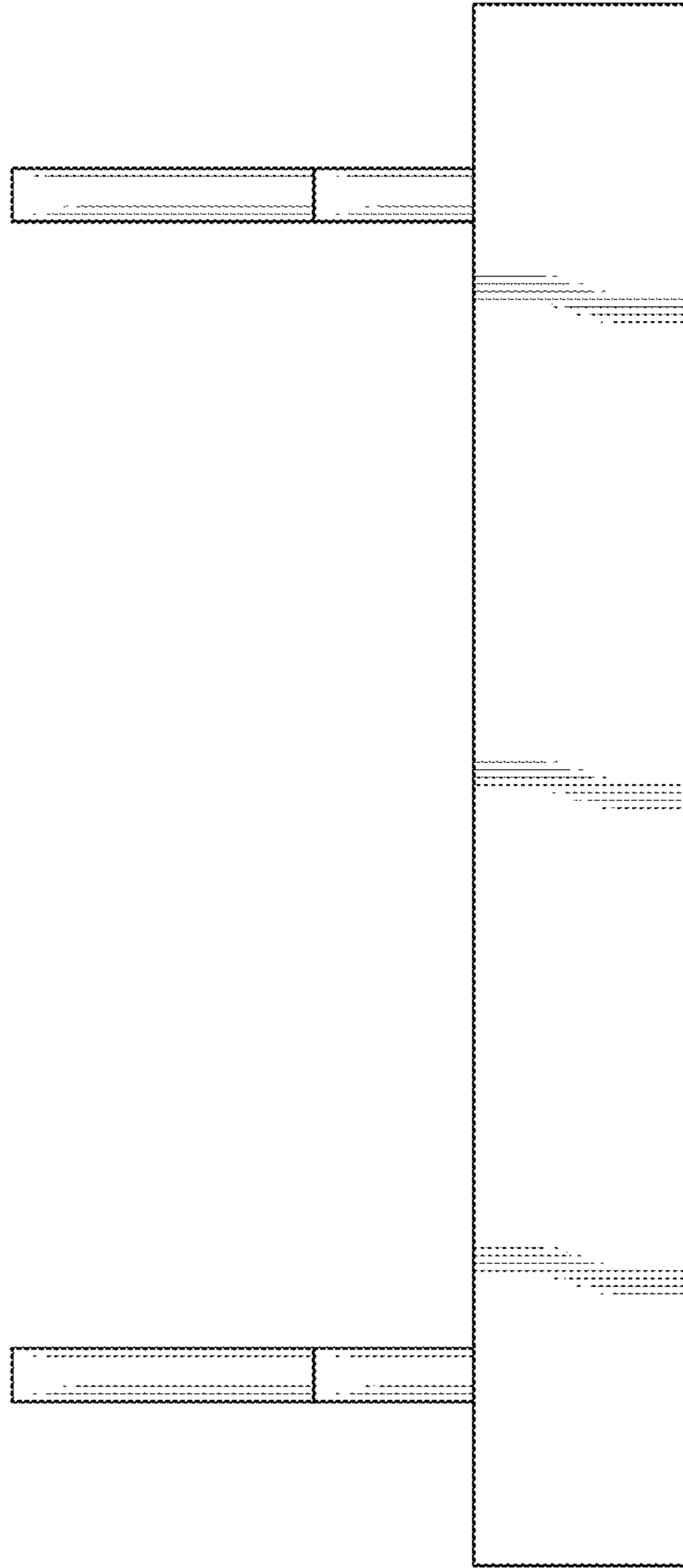

FIG. 2

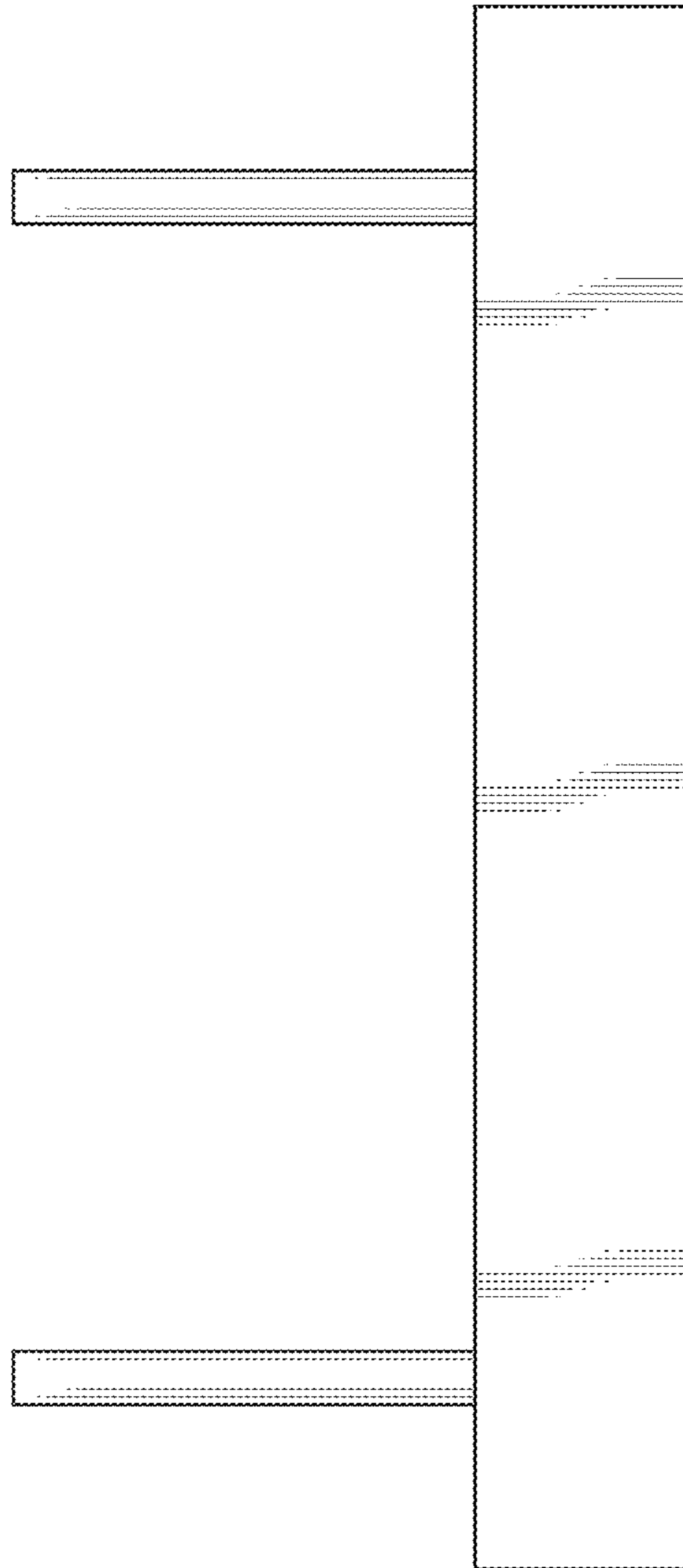

FIG. 3

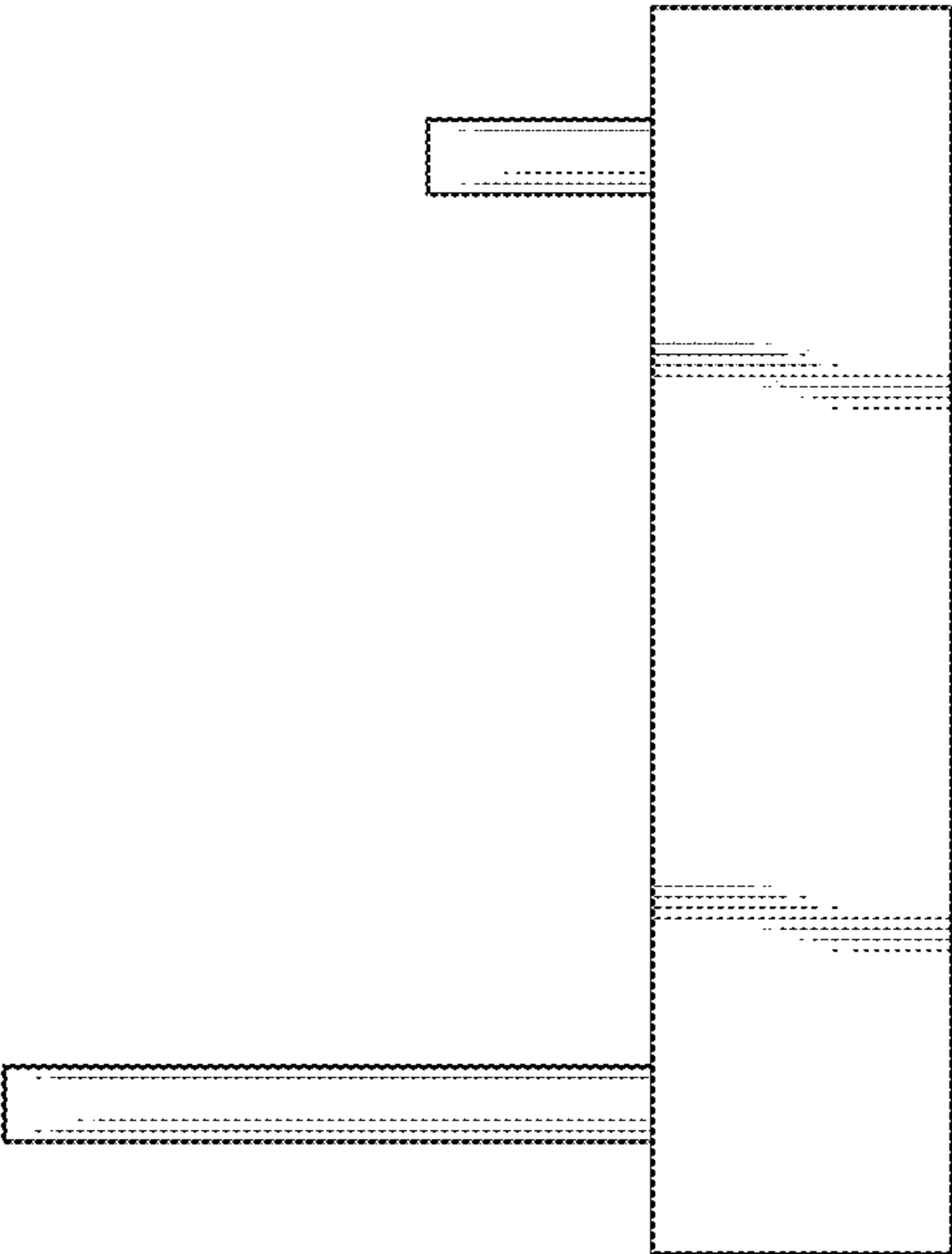

FIG. 4

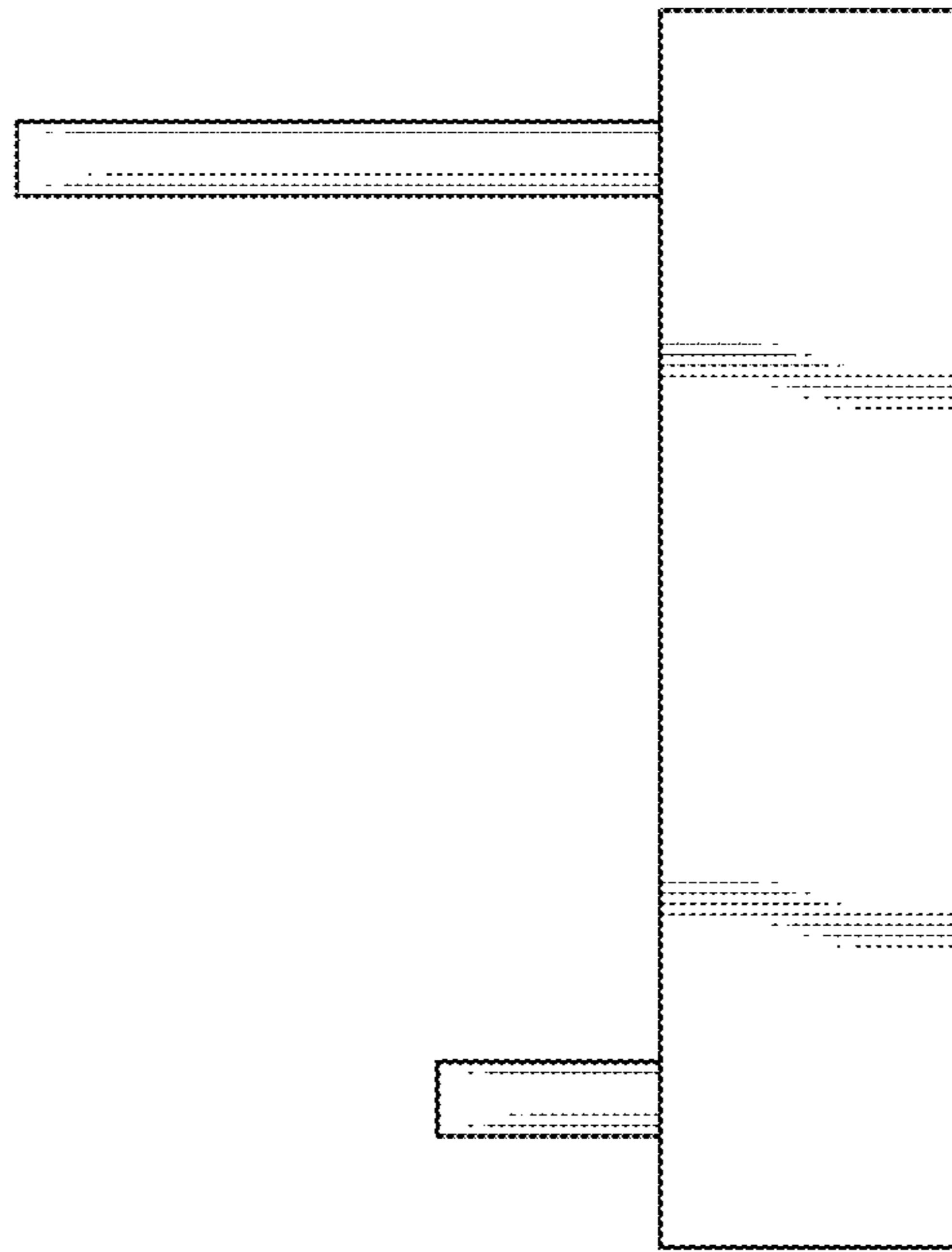

FIG. 5

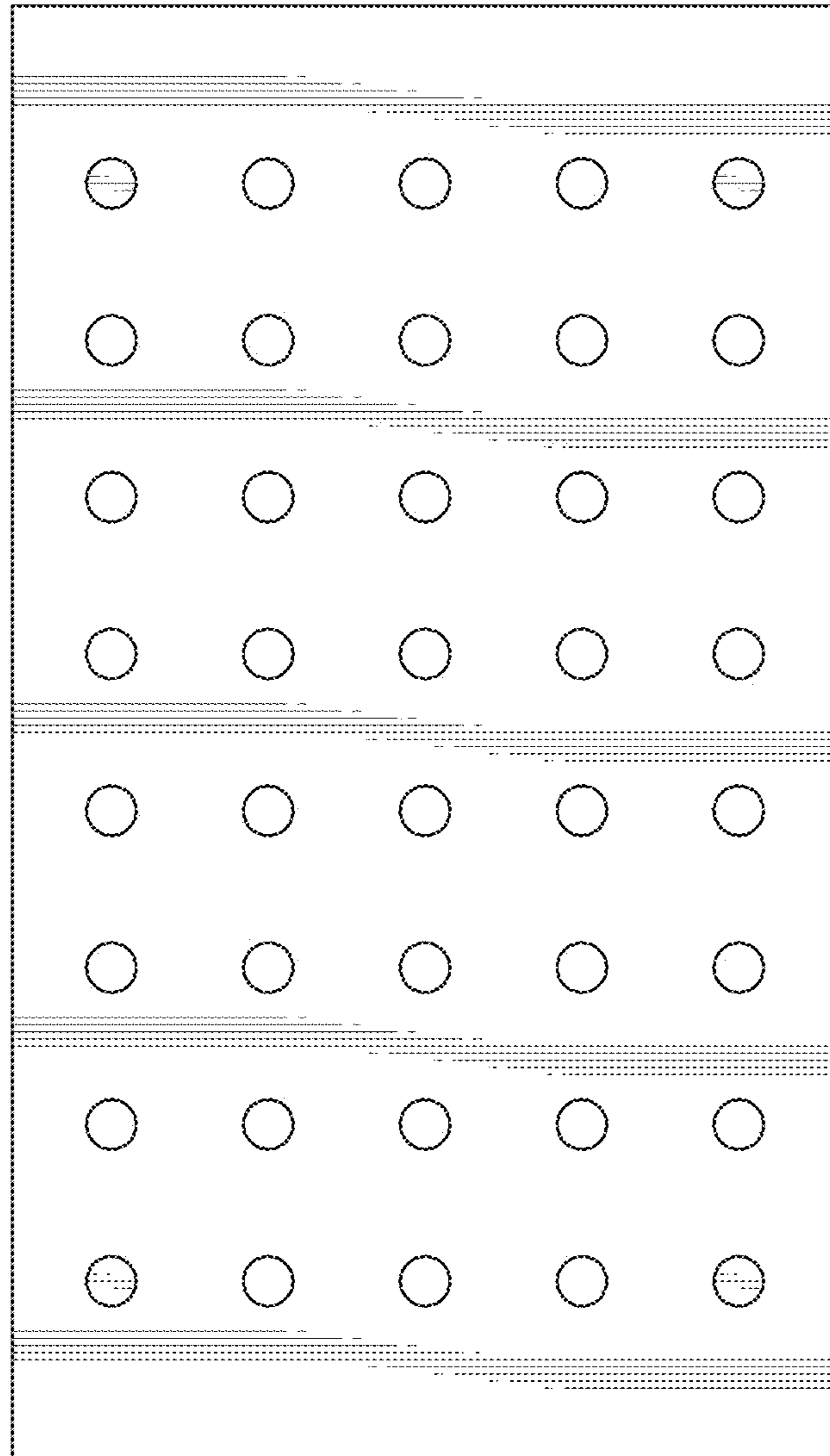

FIG. 6

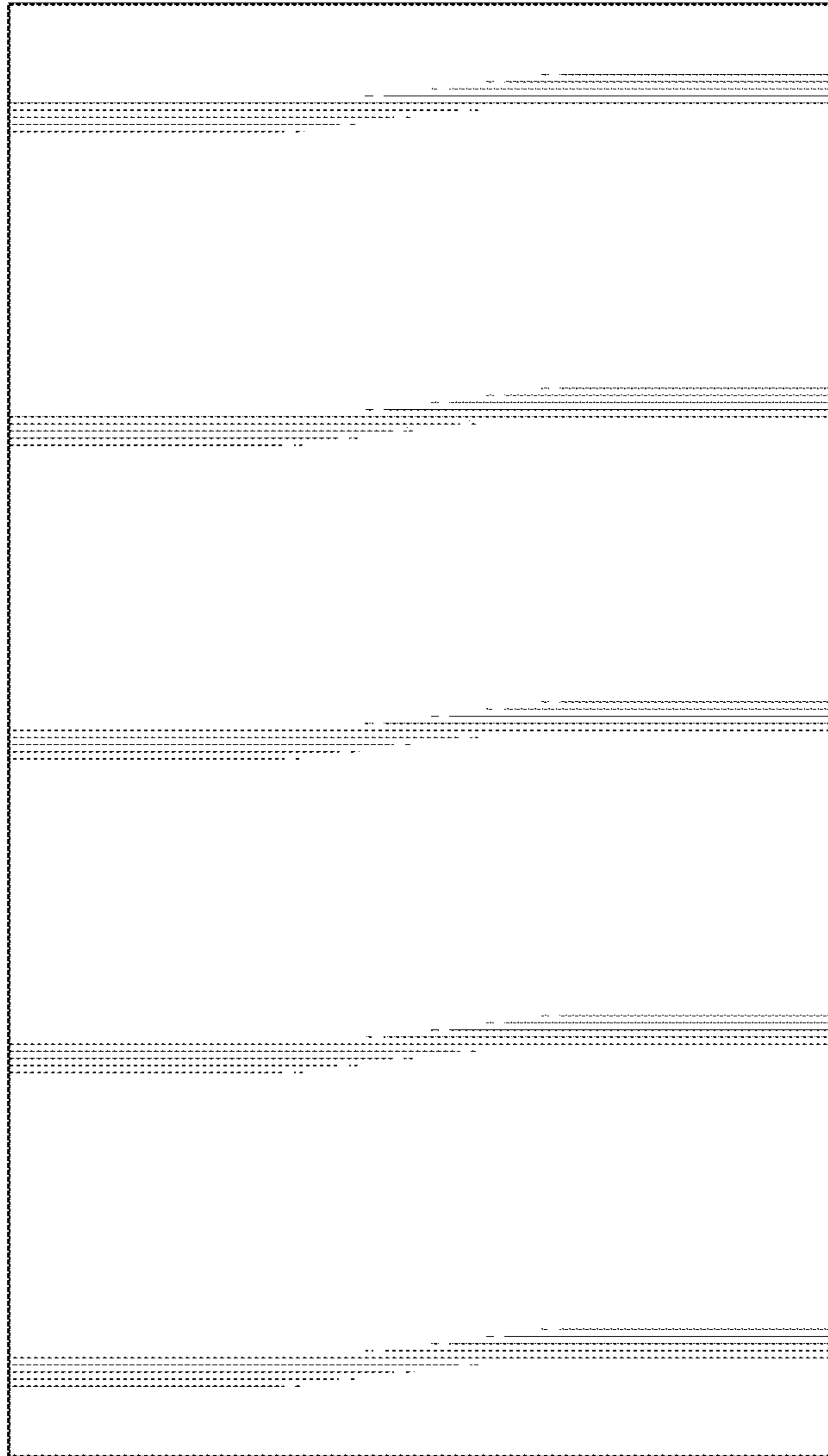

FIG. 7

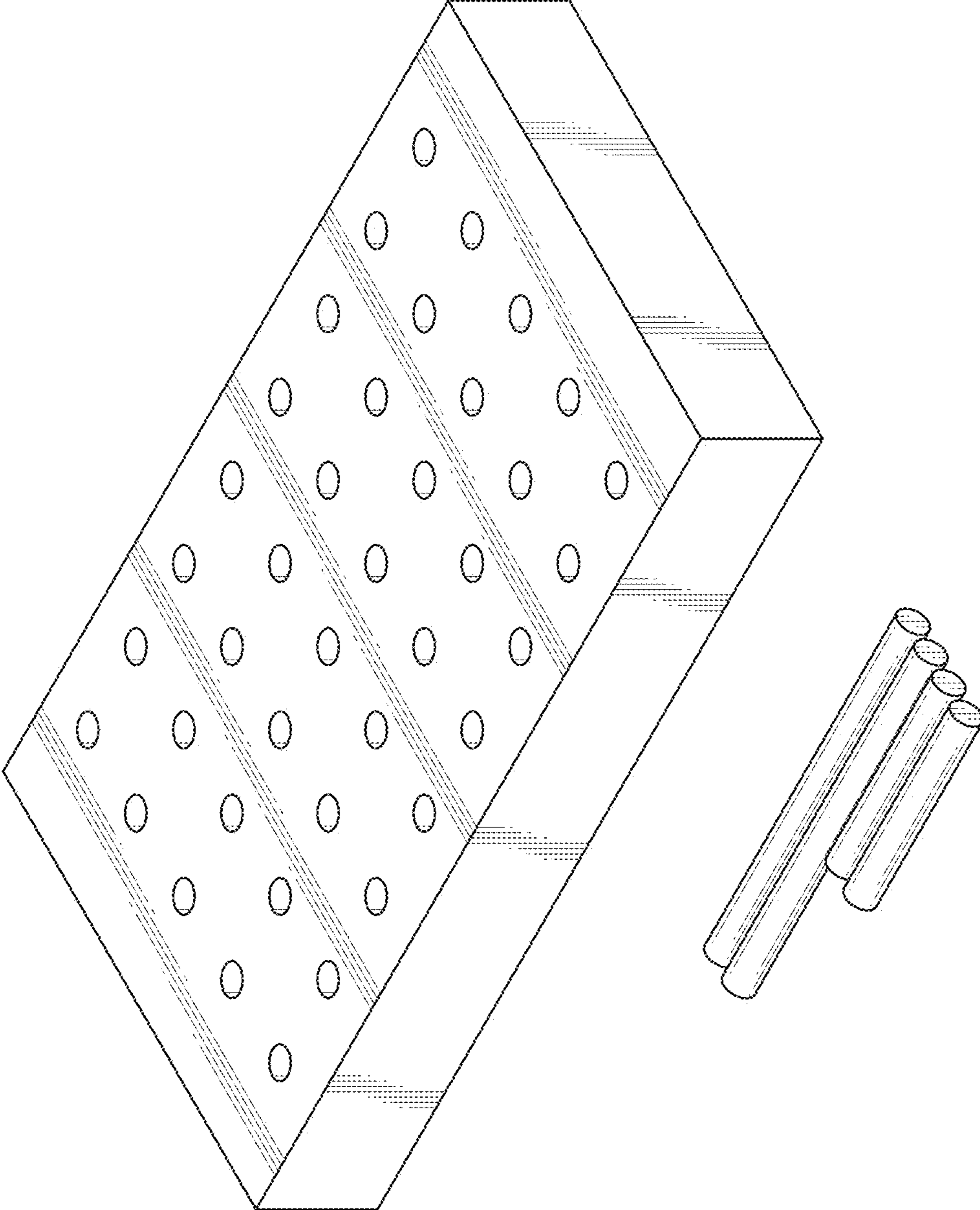

FIG. 8