



US00D938118S

(12) **United States Design Patent** (10) **Patent No.:** **US D938,118 S**
Baker et al. (45) **Date of Patent:** **** Dec. 7, 2021**

(54) **INTERCHANGEABLE SCRUB BRUSH OR SCRUB PAD FOR A FLOOR MAINTENANCE VEHICLE**

(71) Applicant: **Tennant Company**, Minneapolis, MN (US)

(72) Inventors: **Leo J. Baker**, Holland, MI (US); **Jeremy C. Stoddard**, Holland, MI (US); **Steven J. Leibrandt**, Muskegon, MI (US); **Nathan Scott Meyer**, Zeeland, MI (US); **Justin M. Clark**, Hudsonville, MI (US)

(73) Assignee: **Tennant Company**, Eden Prairie, MN (US)

(**) Term: **15 Years**

(21) Appl. No.: **29/638,967**

(22) Filed: **Mar. 2, 2018**

Related U.S. Application Data

(62) Division of application No. 29/521,388, filed on Mar. 23, 2015, now Pat. No. Des. 817,569.

(51) **LOC (13) Cl.** **15-05**

(52) **U.S. Cl.**
USPC **D32/25**
CPC **A47L 11/00** (2013.01)

(58) **Field of Classification Search**

USPC D32/4, 15, 25, 28; D7/368, 675, 677, D7/672; D9/434, 447, 728; D10/64; 15/87, 88.2, 179, 230, 353, 322; 451/285; D4/102, 127, 128
CPC A47L 11/00; A47L 11/02; A47L 11/162; A47L 11/164; A47L 11/283; B24B 23/02; B24B 41/047; A46B 3/00; A46B 13/008

See application file for complete search history.

(56) **References Cited**

U.S. PATENT DOCUMENTS

D424,258 S 5/2000 Pihl et al.
D424,765 S 5/2000 Lund et al.
D425,269 S 5/2000 Pihl et al.
D427,395 S 6/2000 Pihl et al.
D473,685 S 4/2003 McLain et al.
D532,946 S 11/2006 Gansebom et al.
D571,505 S 6/2008 Mettler et al.
D582,113 S 12/2008 van der Meijden et al.
7,587,779 B2 9/2009 Walz et al.
D699,834 S 2/2014 Pan
D701,300 S 3/2014 Tanabe et al.

(Continued)

Primary Examiner — Richard E Chilcot

(74) *Attorney, Agent, or Firm* — Fredrikson & Byron, P.A.

(57) **CLAIM**

Applicant claims the ornamental design for an interchangeable scrub brush or scrub pad for a floor maintenance vehicle, as shown and described.

DESCRIPTION

FIG. 1 is an upper perspective view of an interchangeable scrub brush or scrub pad for a floor maintenance vehicle of Applicant's design;
FIG. 2 is a front elevational view thereof;
FIG. 3 is a rear elevational view thereof;
FIG. 4 is a left-side elevation view thereof;
FIG. 5 is a right-side elevation view thereof;
FIG. 6 is a top plan view thereof;
FIG. 7 is a bottom plan view thereof;
FIG. 8 is a sectional view thereof taken along line 8-8 in FIG. 6;
FIG. 9 is a sectional view thereof taken along line 9-9 in FIG. 6;
FIG. 10 is an enlarged top plan view thereof illustrating the portion within circle 10 in FIG. 6; and,

(Continued)

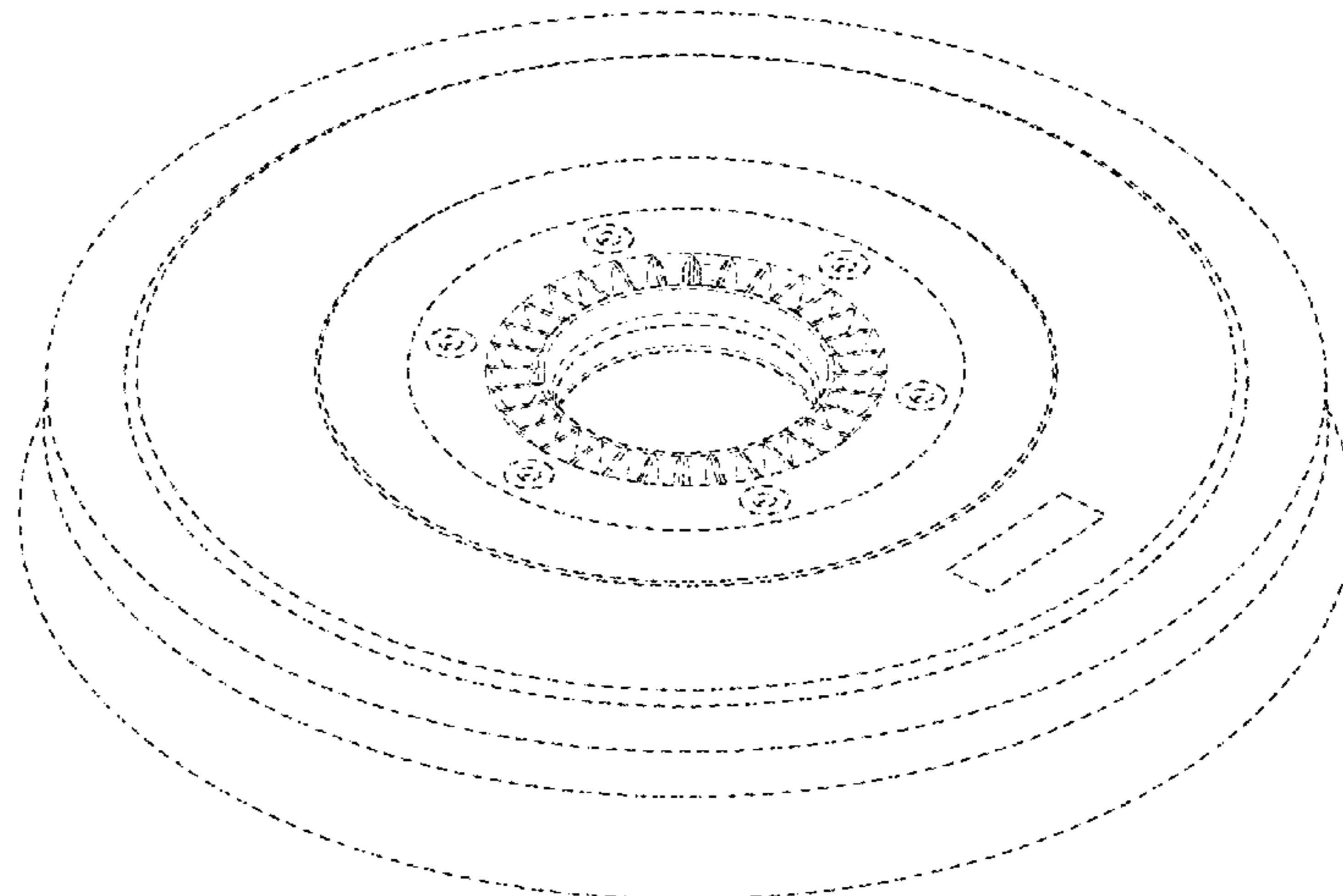

FIG. 11 is a sectional view thereof taken along line 11-11 in FIG. 10.

The broken lines shown represent unclaimed subject matter and form no part of the claimed design.

1 Claim, 8 Drawing Sheets

(56)

References Cited

U.S. PATENT DOCUMENTS

D701,597 S	3/2014	DeFilippis
8,678,186 B2	3/2014	Fabian
D702,829 S	4/2014	Chen et al.
D745,955 S	12/2015	Chen et al.
9,265,397 B2	2/2016	Larson
9,283,655 B2	3/2016	Olari
D759,914 S	6/2016	Goff
9,695,606 B1	7/2017	Allen, Jr.
D795,511 S	8/2017	Jeon et al.
D803,908 S	11/2017	Yamaguchi et al.
D804,230 S	12/2017	Allan et al.
D817,569 S *	5/2018	Baker D32/25

9,980,556 B2	5/2018	Goff
D820,966 S	6/2018	De Filippis
D821,873 S	7/2018	Katopis
D855,914 S *	8/2019	Baker D32/25
D913,612 S *	3/2021	Knowlton D32/25
D917,118 S *	4/2021	Ye D32/25
2008/0216259 A1	9/2008	Walz et al.
2009/0139043 A1	6/2009	Ting
2010/0154153 A1 *	6/2010	Hooper A46B 3/10 15/104.05
2011/0030163 A1 *	2/2011	Tucker A47L 11/305 15/320
2012/0118319 A1 *	5/2012	Stuchlik A47L 11/293 134/6
2013/0157548 A1 *	6/2013	Palushaj B24D 13/16 451/294
2014/0237743 A1 *	8/2014	Baker A47L 11/283 15/98
2015/0216386 A1 *	8/2015	Baker A47L 11/4038 15/49.1
2016/0072416 A1 *	3/2016	Hirovani H02P 25/022 318/400.02
2016/0183755 A1	6/2016	Mundinger et al.
2017/0073050 A1 *	3/2017	Smith E04H 4/1618

* cited by examiner

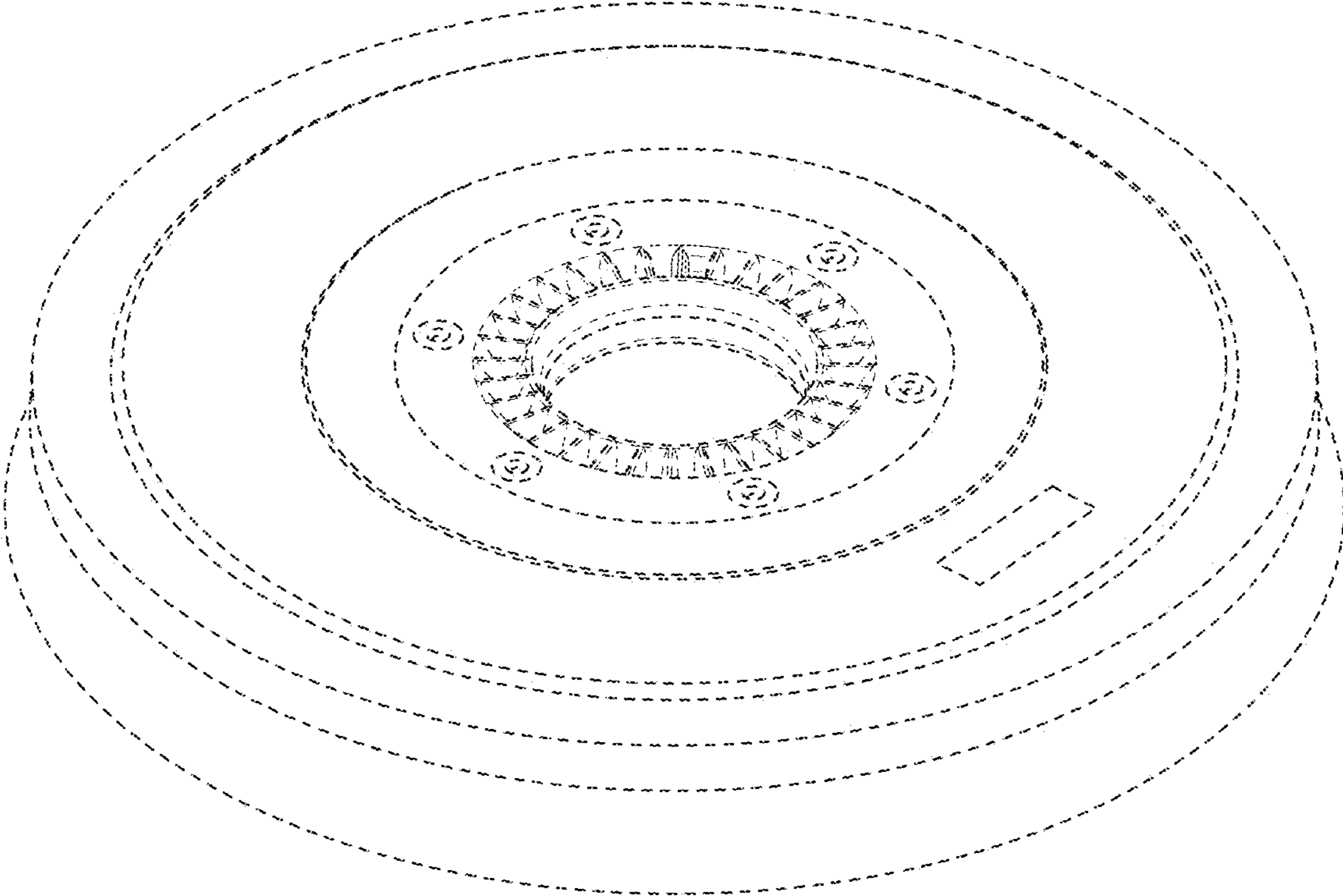

FIG. 1

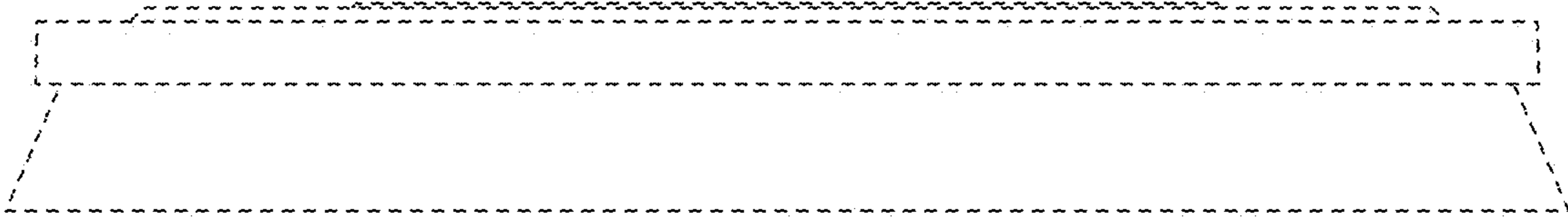

FIG. 2

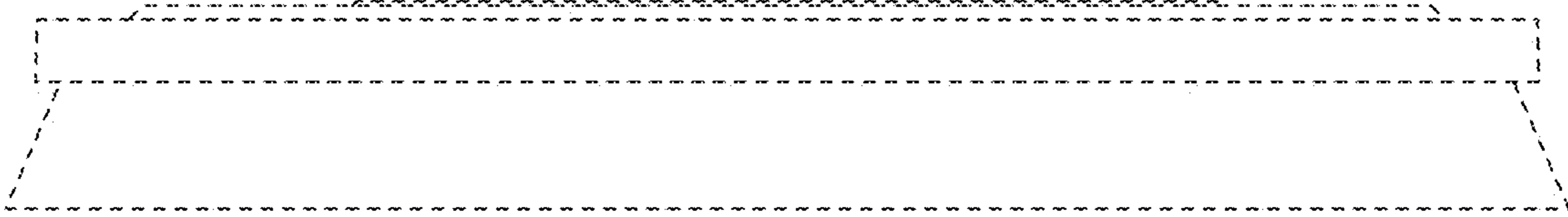

FIG. 3

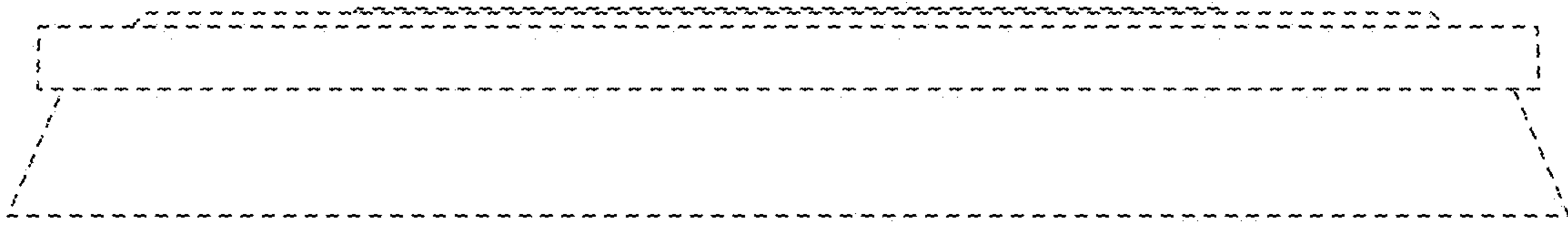

FIG. 4

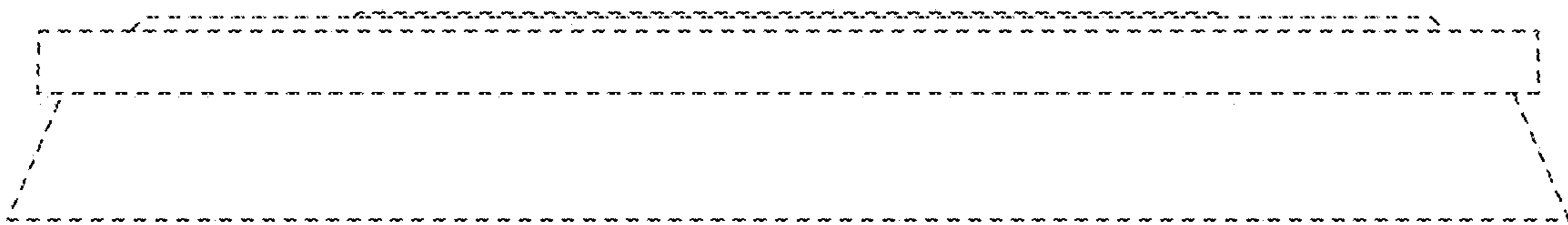

FIG. 5

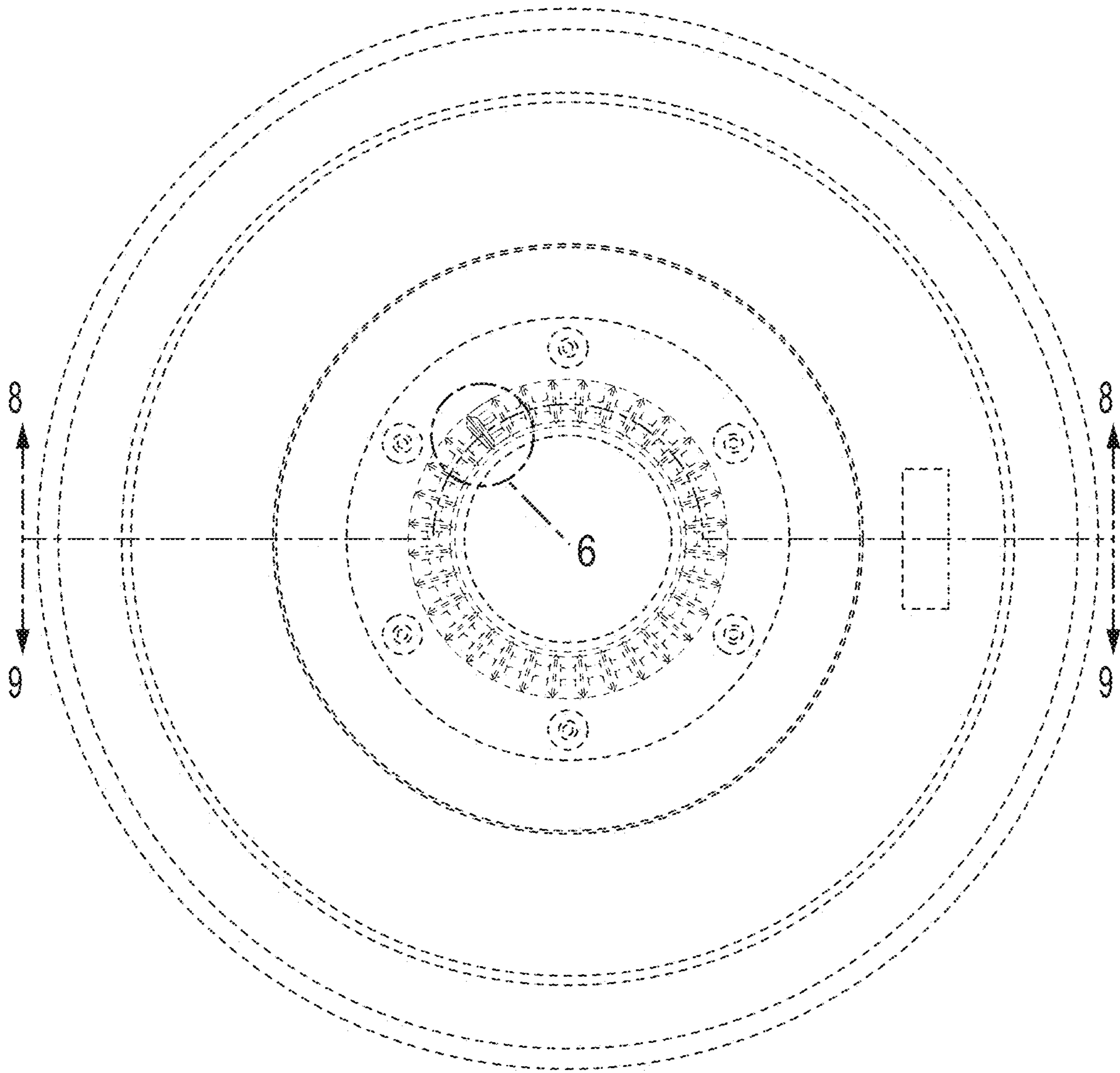

FIG. 6

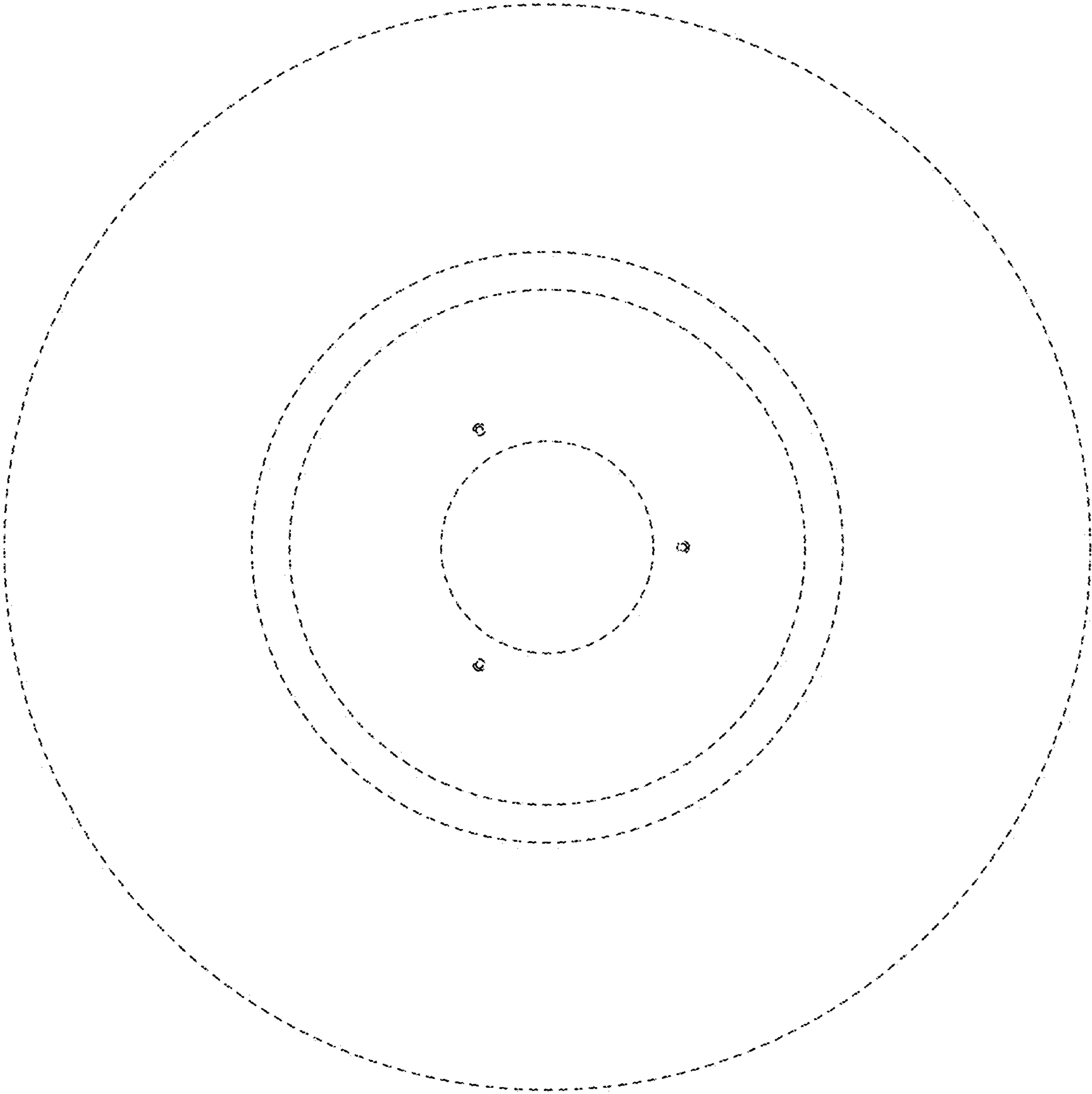

FIG. 7

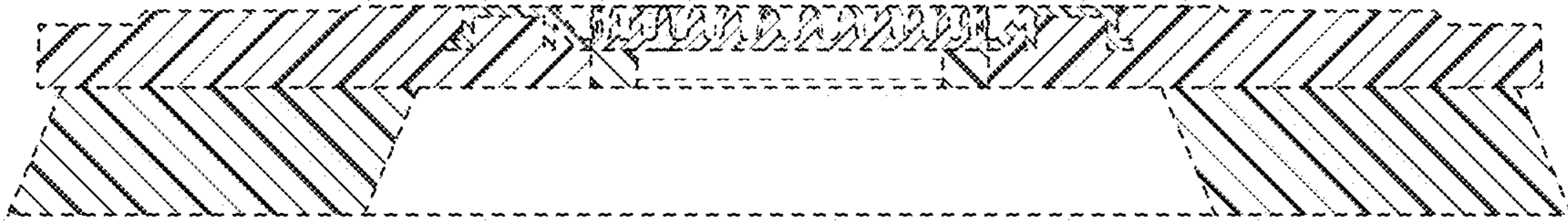

FIG. 8

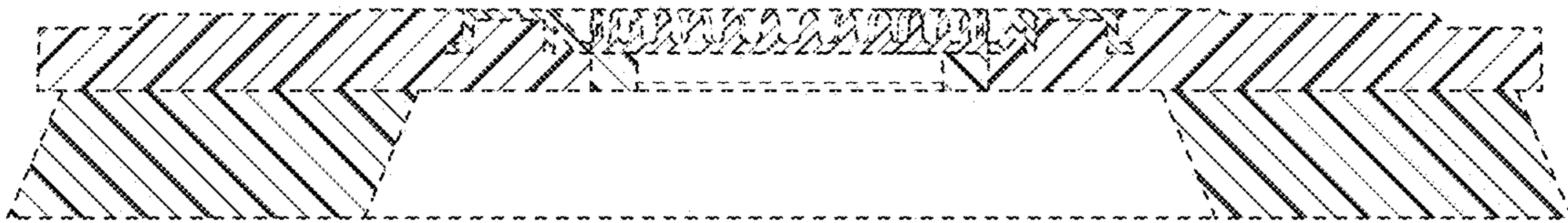

FIG. 9

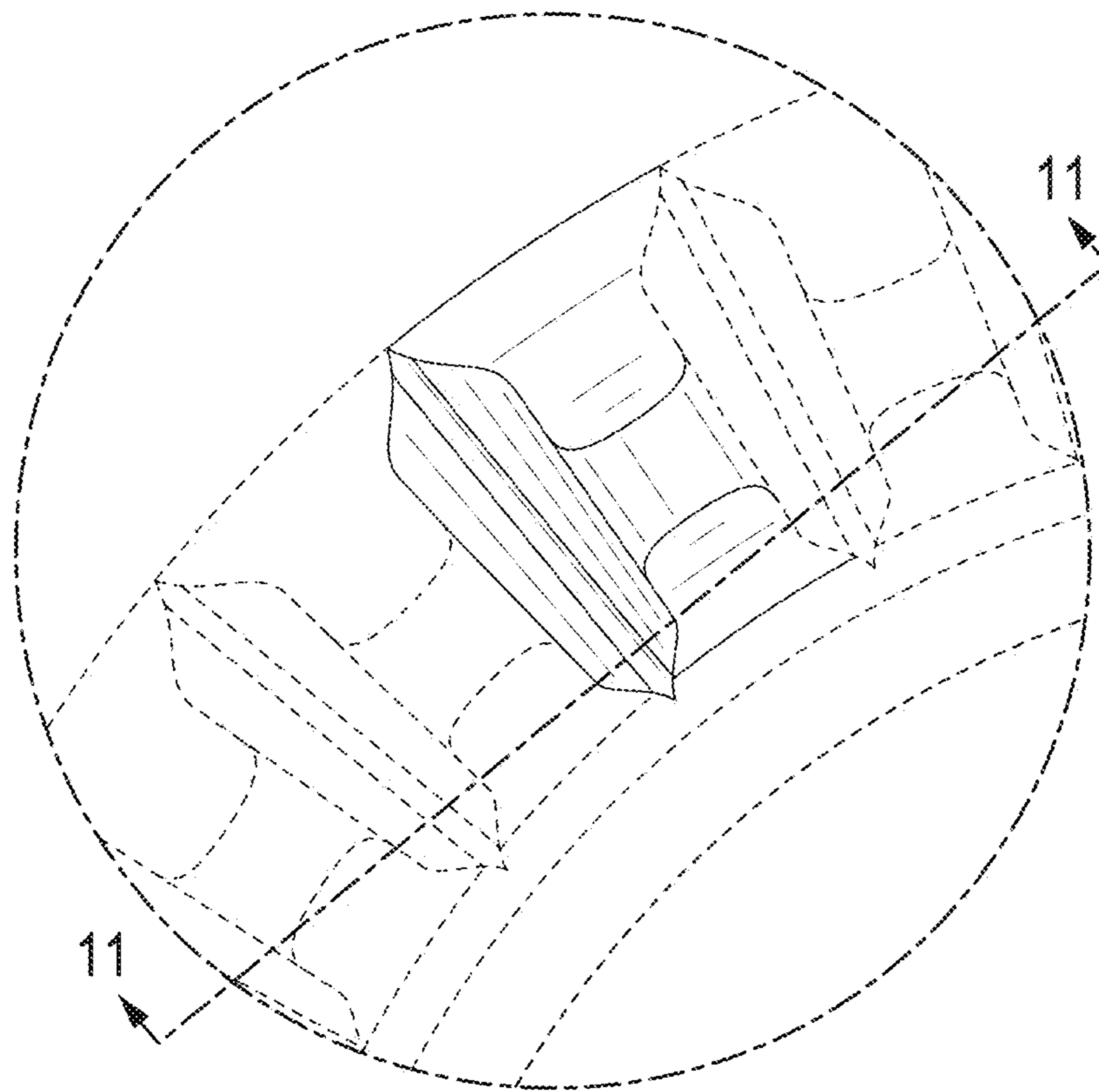

FIG. 10

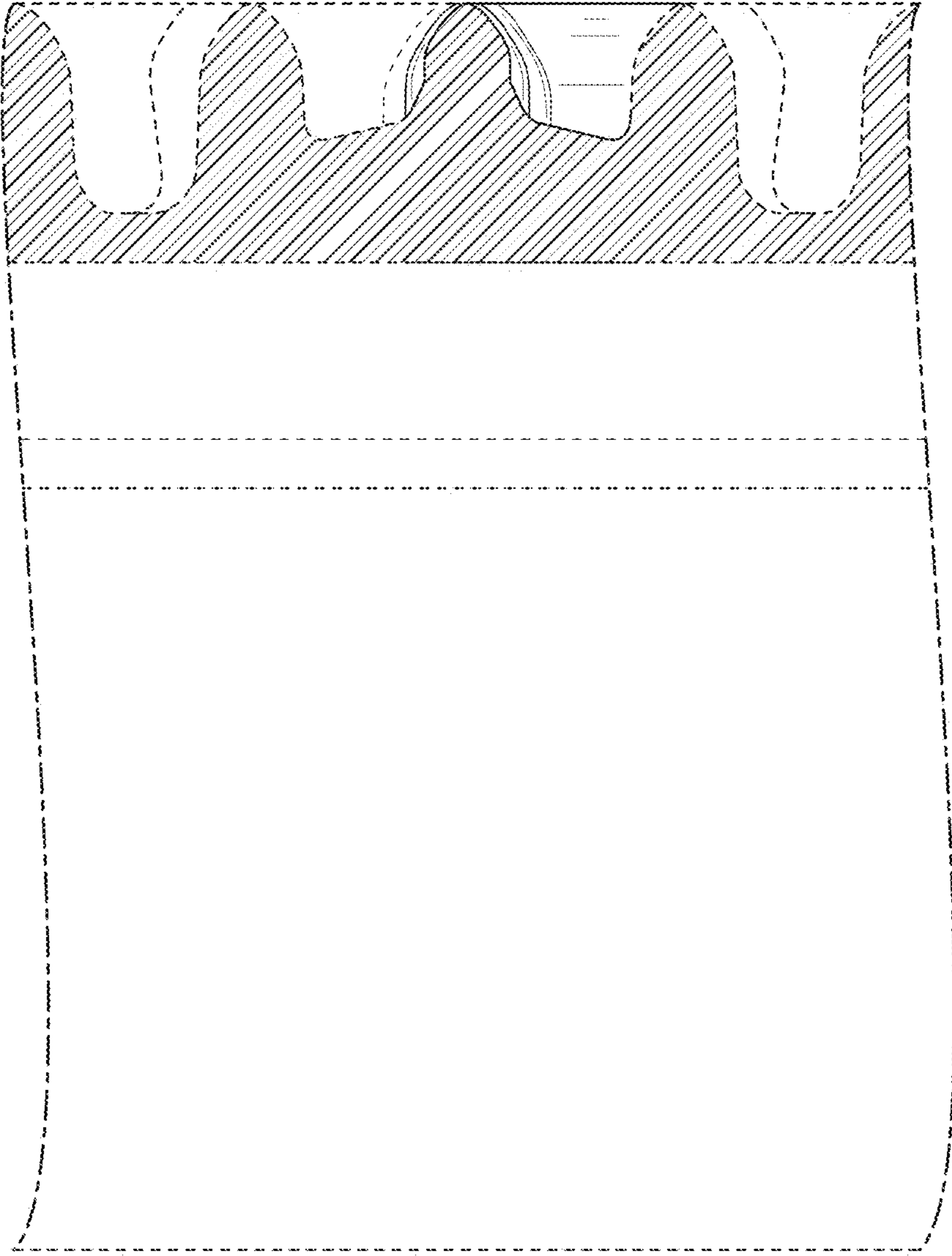

FIG. 11