



US00D937989S

(12) **United States Design Patent** (10) **Patent No.:** **US D937,989 S**
Jin (45) **Date of Patent:** **** Dec. 7, 2021**

(54) **ELEPHANT FAUCET COVER**
(71) Applicant: **Zhejiang Jike Industry & Trade Co., Ltd.**, Yongkang (CN)
(72) Inventor: **Dazhong Jin**, Yongkang (CN)
(**) Term: **15 Years**
(21) Appl. No.: **29/723,811**

(22) Filed: **Feb. 11, 2020**
(51) **LOC (13) Cl.** **23-01**
(52) **U.S. Cl.**
USPC **D23/256**
(58) **Field of Classification Search**
USPC D23/257, 249, 254, 259, 255, 233, 234, D23/235, 236, 237, 238, 240, 241, 242, D23/243, 244, 245, 246, 247, 248, 250, D23/251, 252, 253, 256, 213; D21/616
CPC E03C 1/01; E03C 1/0409; E03C 1/025; E03C 1/0408; Y10T 137/5339; Y10T 137/6014; Y10T 137/6021; Y10T 137/87579; A47K 3/001; A47K 3/005
See application file for complete search history.

(56) **References Cited**

U.S. PATENT DOCUMENTS

3,199,121 A * 8/1965 Greto A47K 3/001
4/675
D282,563 S * 2/1986 Beene D21/616
D326,312 S * 5/1992 Frankel D23/256
5,337,956 A * 8/1994 Crutcher B05B 17/08
239/211
6,205,598 B1 * 3/2001 Black A47K 3/001
4/580
D465,009 S * 10/2002 Siefken A47K 3/005
D21/616
D501,040 S * 1/2005 Gieson A47K 3/005
D23/222
D612,492 S * 3/2010 Krumins D24/127
D691,699 S * 10/2013 Berger D23/213

9,909,685 B1 * 3/2018 Flores F16K 35/00
D889,607 S * 7/2020 Jin D23/255
2007/0277891 A1 * 12/2007 Frankel A47K 3/005
137/801

(Continued)

FOREIGN PATENT DOCUMENTS

CN 201830706537.9 * 12/2018
KR 3020130052546 * 10/2013

OTHER PUBLICATIONS

Youtube, PUJ Snug, posted Feb. 20, 2014, [online], [visited Apr. 21, 2021]. Internet, <URL: <https://www.youtube.com/watch?v=9r7-YhHnBns>> (Year: 2014).*

(Continued)

Primary Examiner — Wendy L Arminio
Assistant Examiner — Samantha N Wood
(74) *Attorney, Agent, or Firm* — Rumit Ranjit Kanakia

(57) **CLAIM**

I claim the ornamental design for an elephant faucet cover, as shown and described.

DESCRIPTION

The file of this patent contains at least one drawing/photograph executed in color. Copies of this patent with color drawing(s)/photograph(s) will be provided by the Office upon request and payment of the necessary fee.

FIG. 1 is a perspective view of an elephant faucet cover showing my new design;
FIG. 2 is a front view thereof;
FIG. 3 is a back view thereof;
FIG. 4 is a right-side view thereof;
FIG. 5 is a left-side view thereof;
FIG. 6 is a top view thereof; and,
FIG. 7 is a bottom view thereof.

1 Claim, 7 Drawing Sheets
(7 of 7 Drawing Sheet(s) Filed in Color)

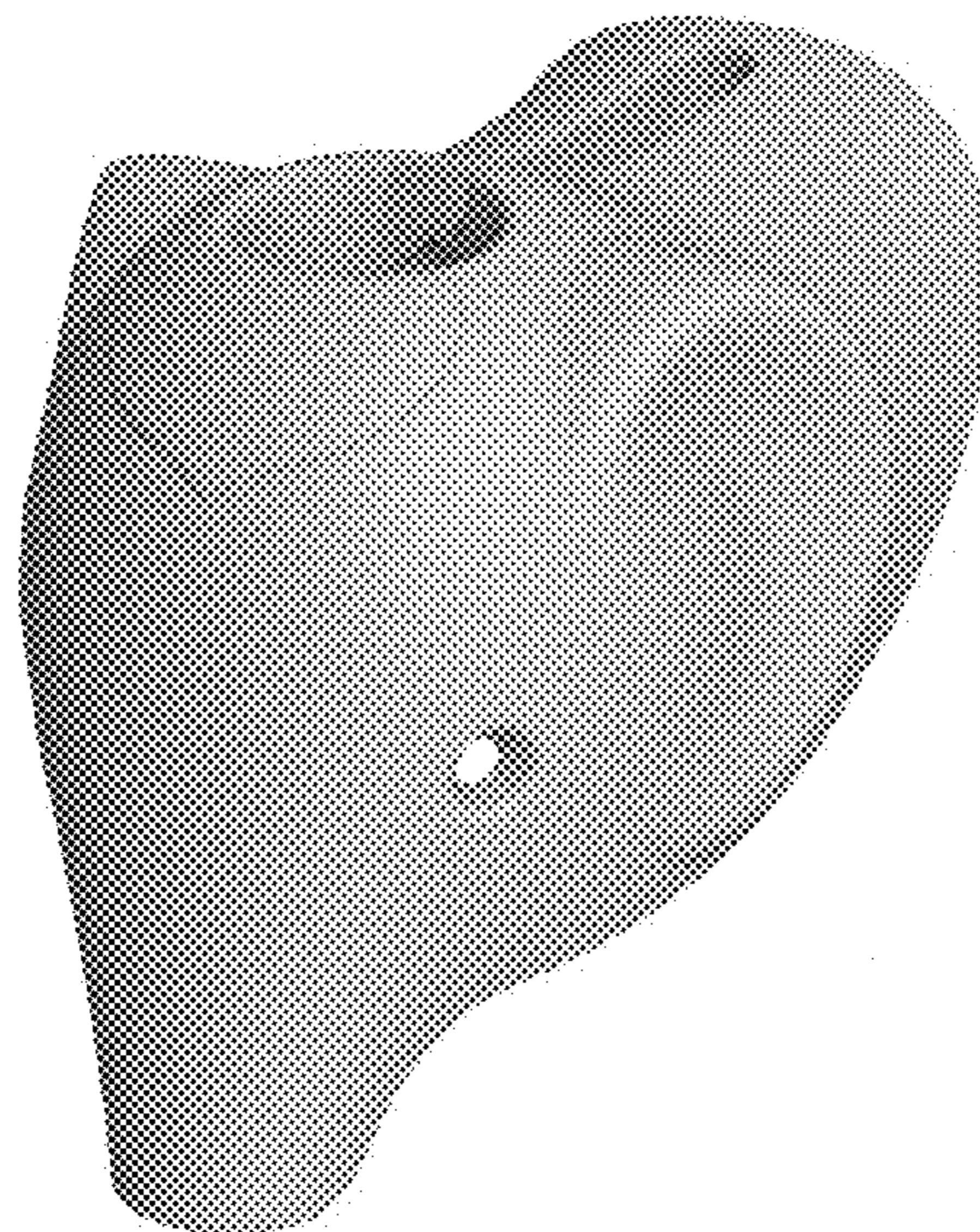

(56)

References Cited

U.S. PATENT DOCUMENTS

2011/0023979 A1* 2/2011 Henderson A47K 3/005
137/377

OTHER PUBLICATIONS

Amazon, Fliyeong Premium Quality Bath Cover, posted Mar. 22, 2019, [online], [visited Jun. 15, 2021]. Internet, <URL: <https://www.amazon.co.uk/dp/B07PWKR1F5/ref>> (Year: 2019).*

* cited by examiner

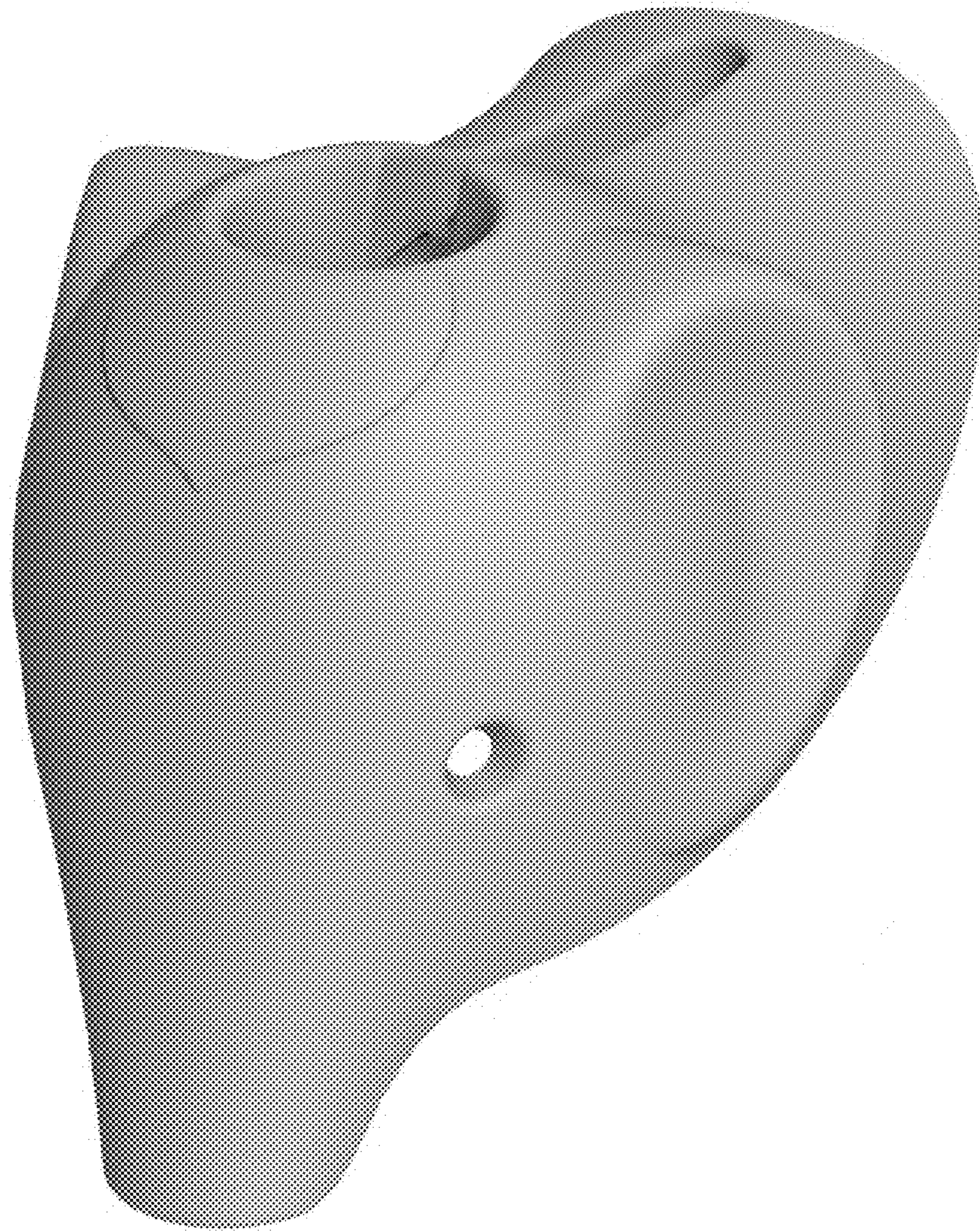

FIG. 1

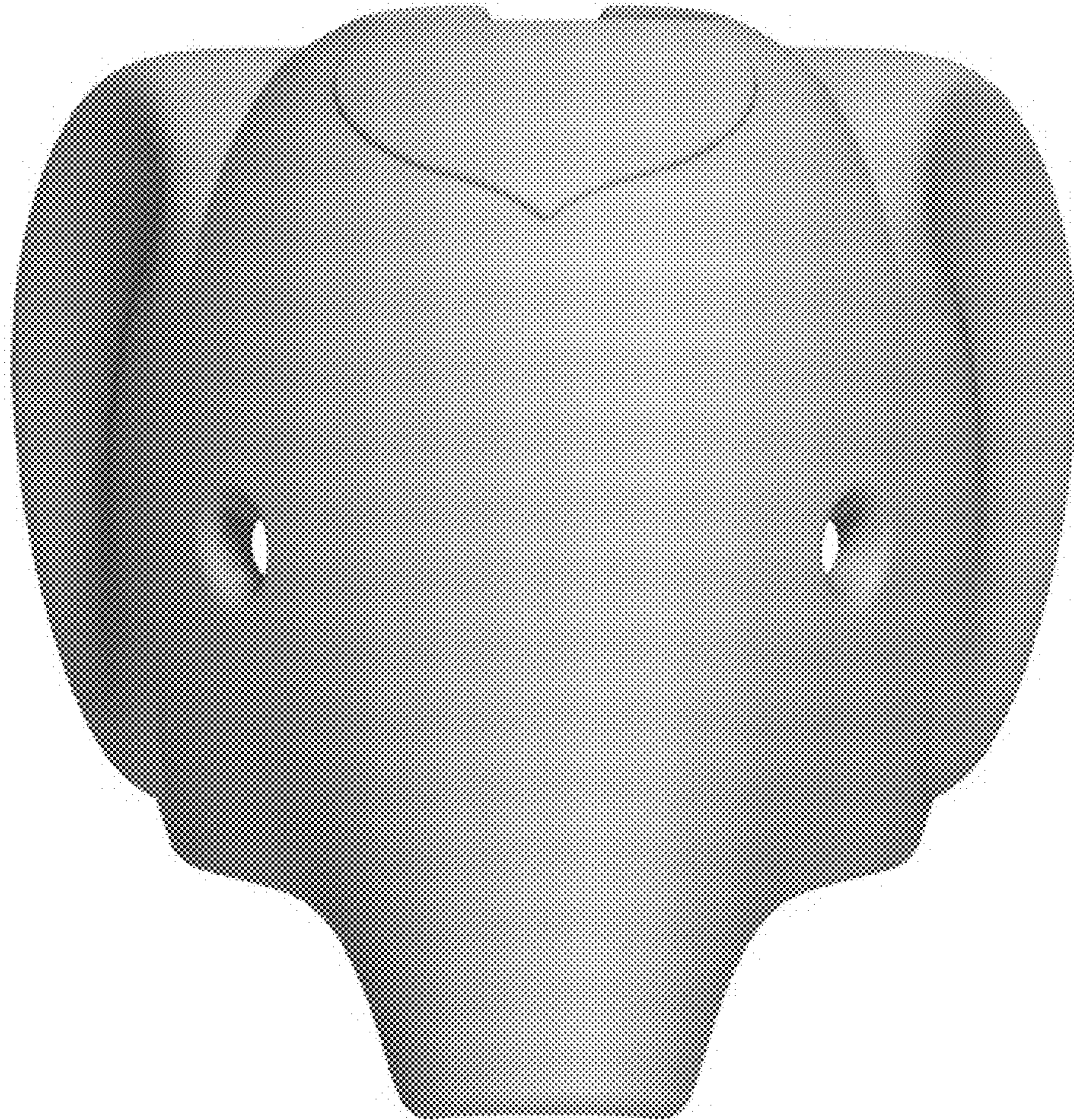

FIG. 2

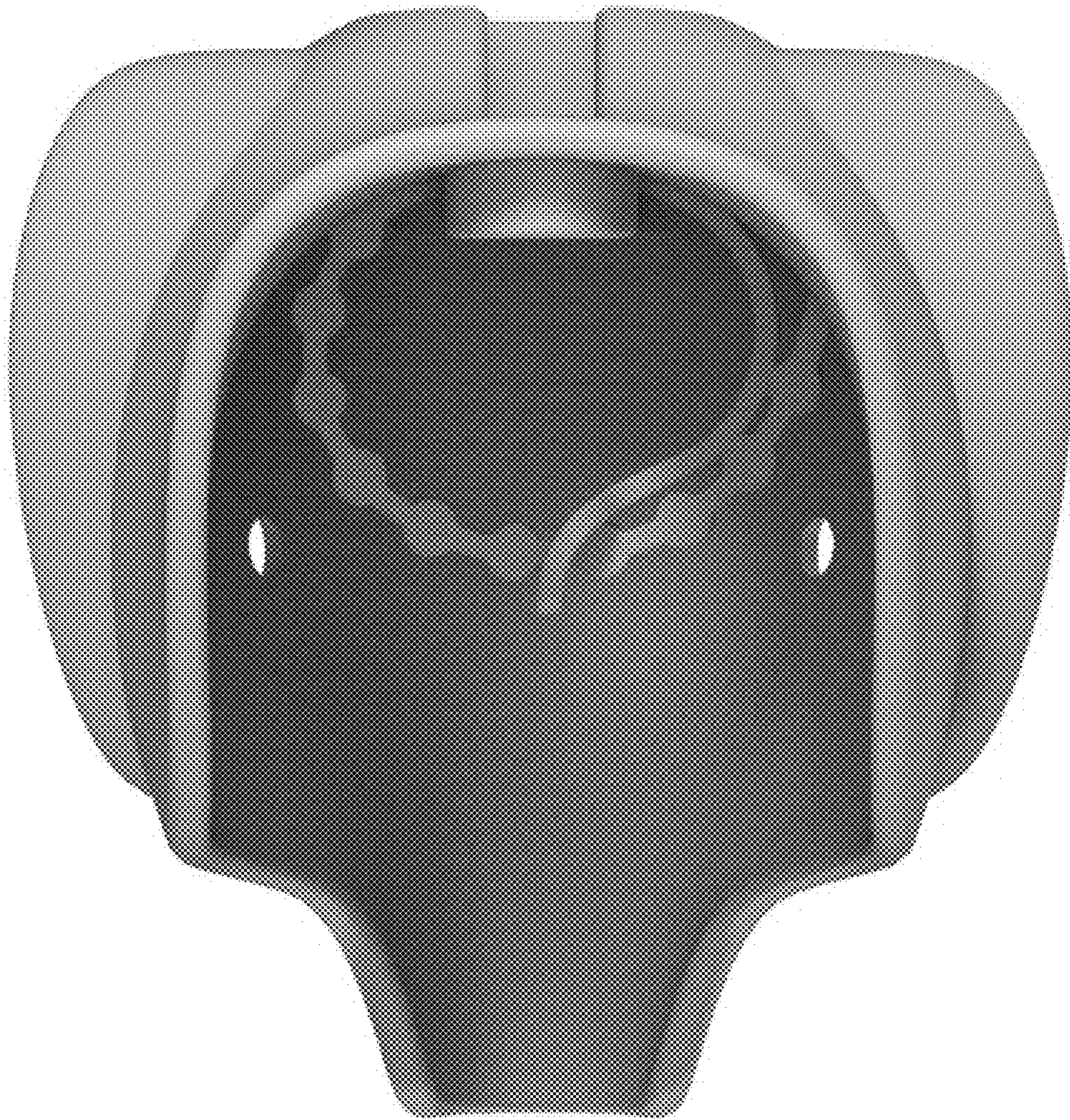

FIG. 3

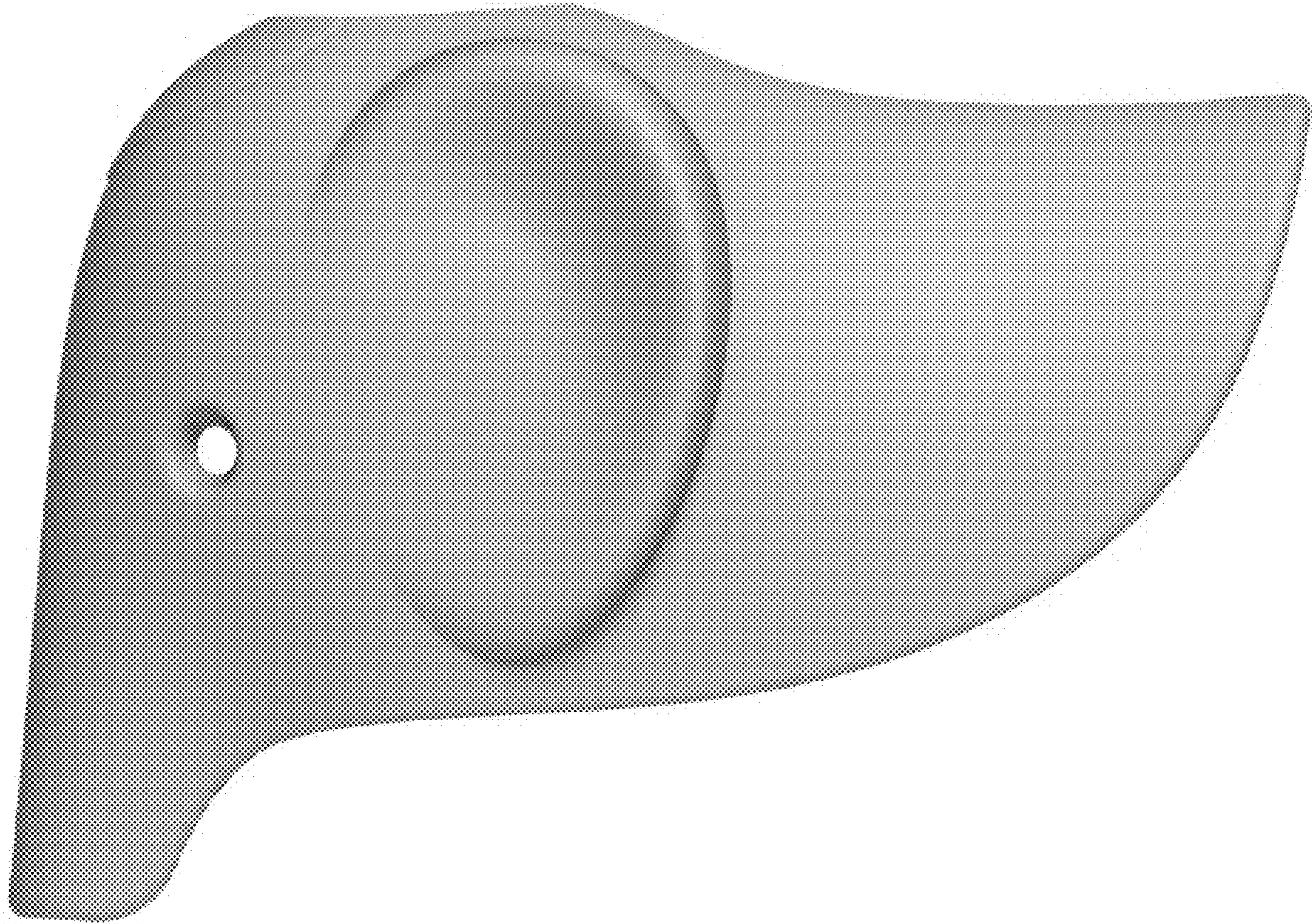

FIG. 4

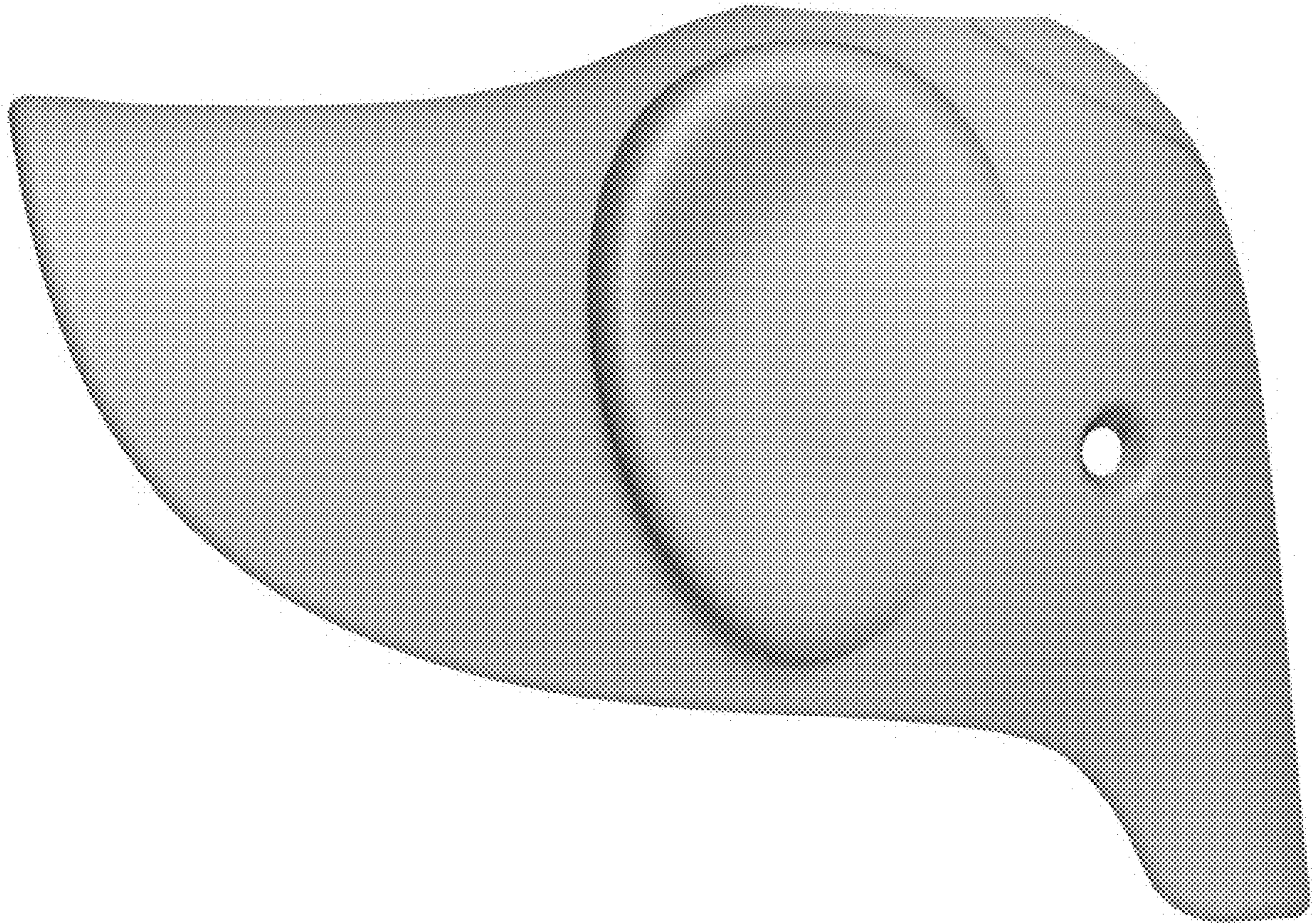

FIG. 5

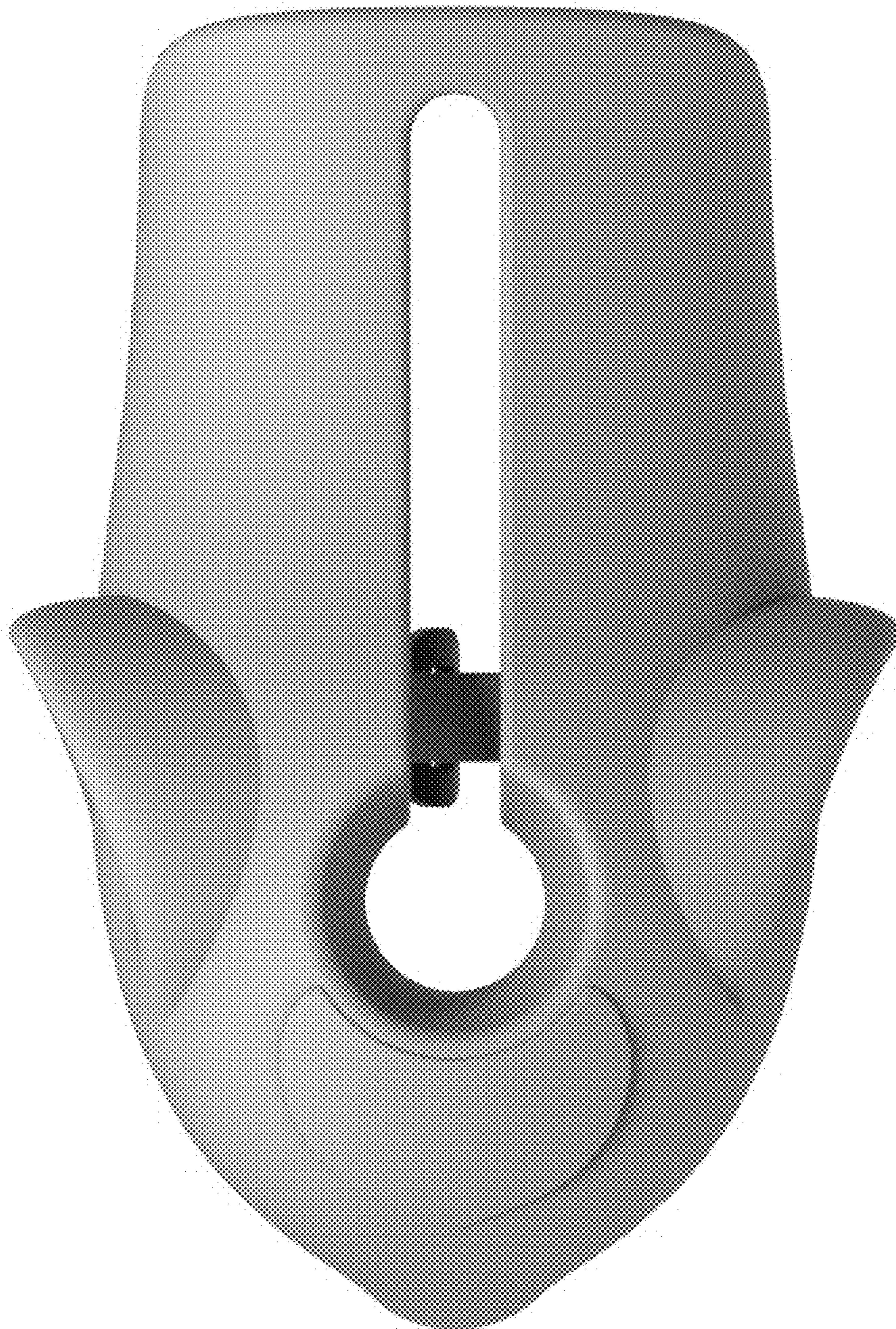

FIG. 6

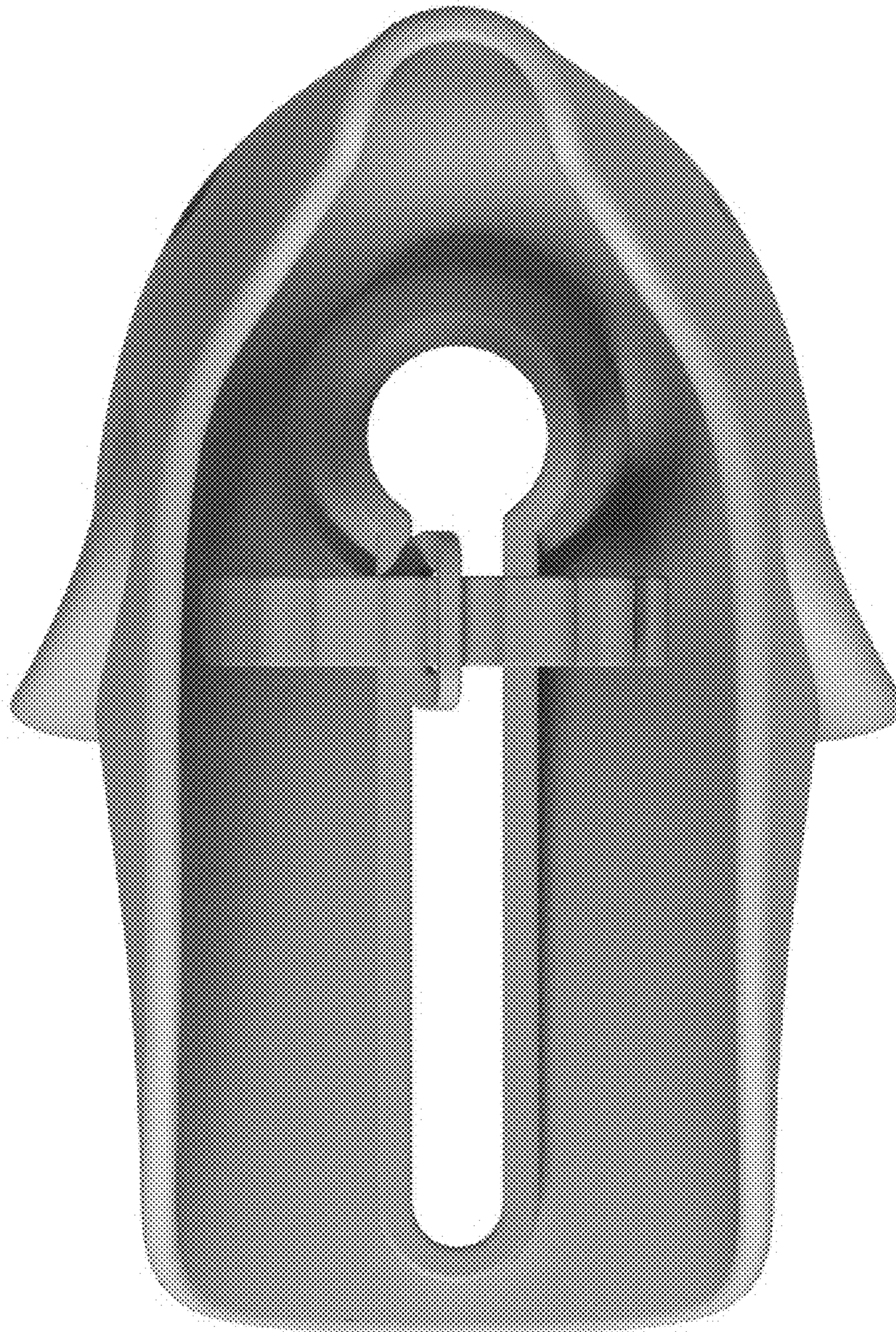

FIG. 7