



US00D937935S

(12) **United States Design Patent** (10) **Patent No.:** **US D937,935 S**
Cai (45) **Date of Patent:** **** Dec. 7, 2021**

(54) **SEA HORSE BUBBLE GUN**

(71) Applicant: **Ciken Cai**, Shantou (CN)

(72) Inventor: **Ciken Cai**, Shantou (CN)

(**) Term: **15 Years**

(21) Appl. No.: **29/787,102**

(22) Filed: **Jun. 4, 2021**

(30) **Foreign Application Priority Data**

May 25, 2021 (CN) 202130314788.4

(51) **LOC (13) Cl.** **21-01**

(52) **U.S. Cl.**
USPC **D21/401; D21/597**

(58) **Field of Classification Search**
USPC D21/401, 402, 472, 473, 474, 597, 599,
D21/572, 575; D23/215, 222, 251, 256;
446/15-21

CPC A63H 3/003; A63H 3/26; A63H 23/00;
A63H 23/10; A63H 23/16

See application file for complete search history.

(56) **References Cited**

U.S. PATENT DOCUMENTS

D192,170 S *	2/1962	Kovac	D21/599
D276,834 S *	12/1984	Paczko	D21/599
D277,879 S *	3/1985	Brown	D21/401
D419,204 S *	1/2000	Bao	D21/401
D674,026 S	1/2013	Roos et al.	
D761,365 S	7/2016	Champ	
D785,741 S *	5/2017	George, II	D21/808
D803,947 S *	11/2017	Lo	D21/401
D842,390 S	3/2019	Iwasawa	
D853,512 S *	7/2019	Zucchelli	D21/808
D895,736 S *	9/2020	Chen	D21/401
D927,642 S *	8/2021	Wu	D23/222

2003/0073374 A1*	4/2003	Thai	A63H 33/28 446/15
2004/0155058 A1*	8/2004	Dunham	A63H 33/28 222/79
2005/0003731 A1*	1/2005	LaFata	A63H 31/08 446/24
2012/0231697 A1*	9/2012	Matheny	A63H 3/20 446/72

FOREIGN PATENT DOCUMENTS

CN	3266794	*	12/2002	
CN	302469352	*	6/2013	
CN	302490087	*	7/2013	
CN	305813643	*	5/2020	
CN	306322757	*	2/2021	
CN	306523054	*	5/2021	
KR	300788527.0000	*	3/2015	
WO	WO-2004012831 A2	*	2/2004 A63H 33/28

* cited by examiner

Primary Examiner — Catherine A Tuttle

(57) **CLAIM**

The ornamental design for a sea horse bubble gun, as shown and described.

DESCRIPTION

FIG. 1 is a first perspective view of a sea horse bubble gun showing my new design;
 FIG. 2 is a second perspective view thereof;
 FIG. 3 is a front view thereof;
 FIG. 4 is a back view thereof;
 FIG. 5 is a left side view thereof;
 FIG. 6 is a right side view thereof;
 FIG. 7 is a top view thereof;
 FIG. 8 is a bottom view thereof; and,
 FIG. 9 is an enlarged view of the selected portion in FIG. 1.
 The broken lines shown in the drawings depict portions of the sea horse bubble gun in which the design is embodied that form no part of the claimed design.

1 Claim, 9 Drawing Sheets

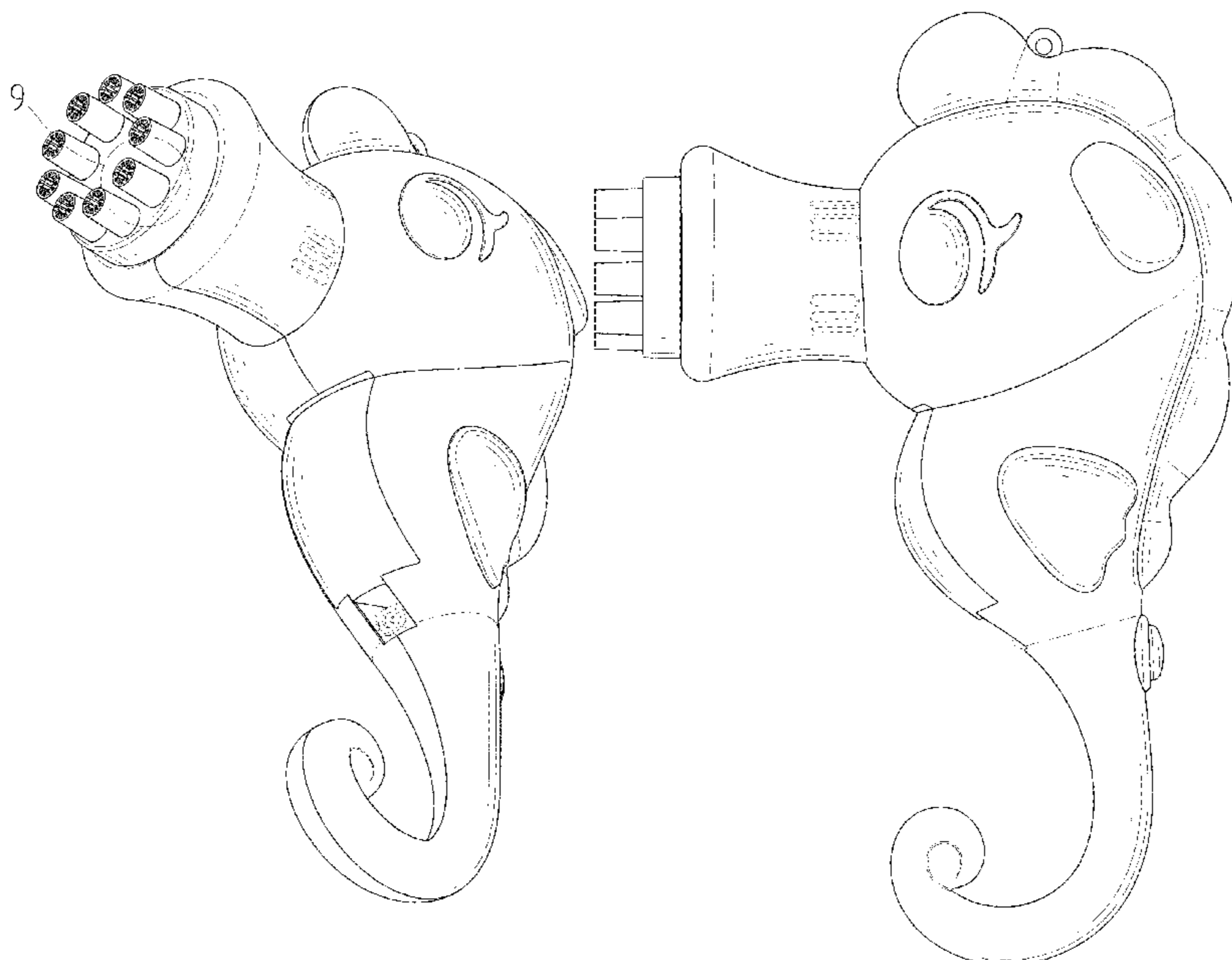

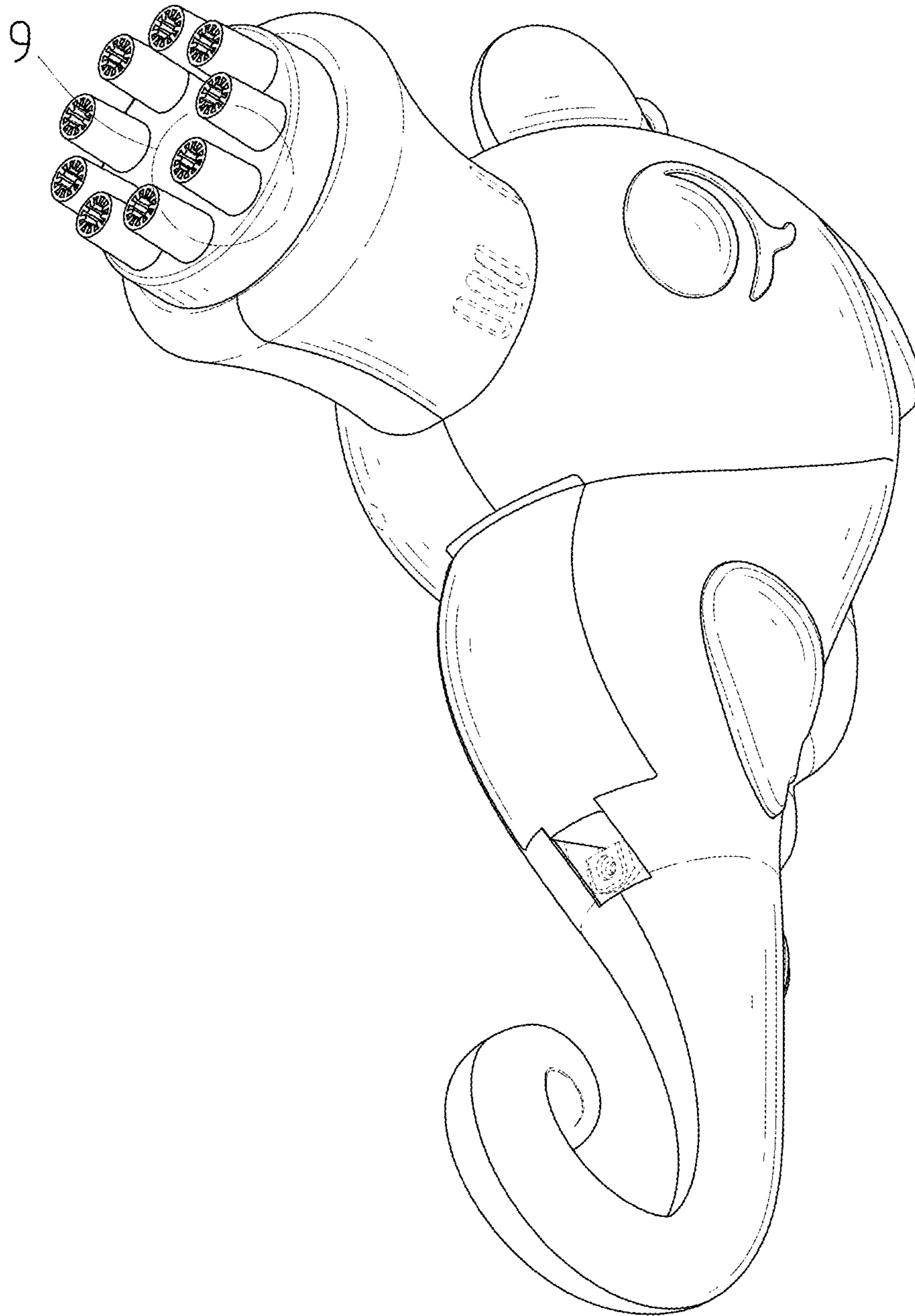

FIG. 1

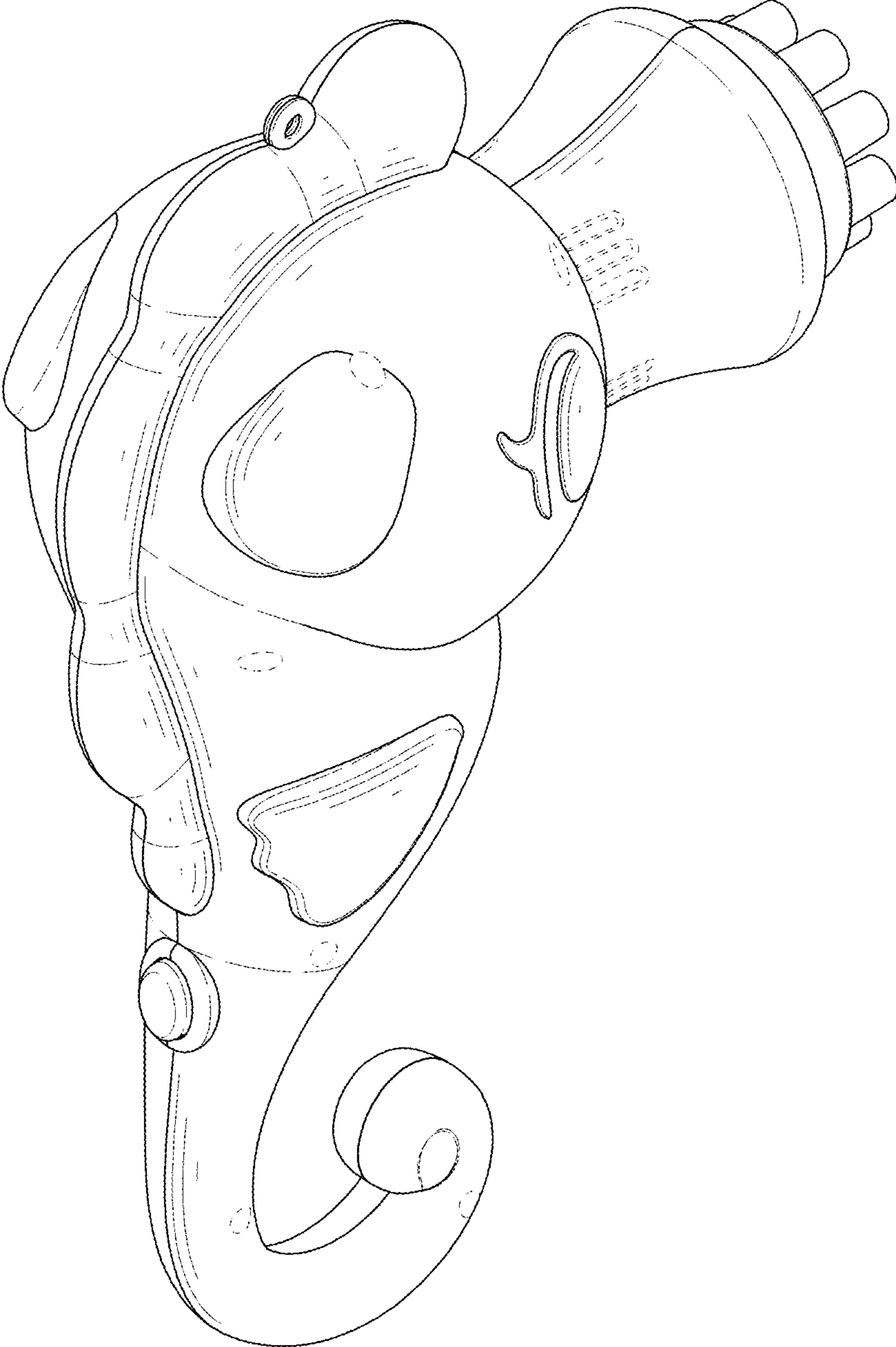

FIG. 2

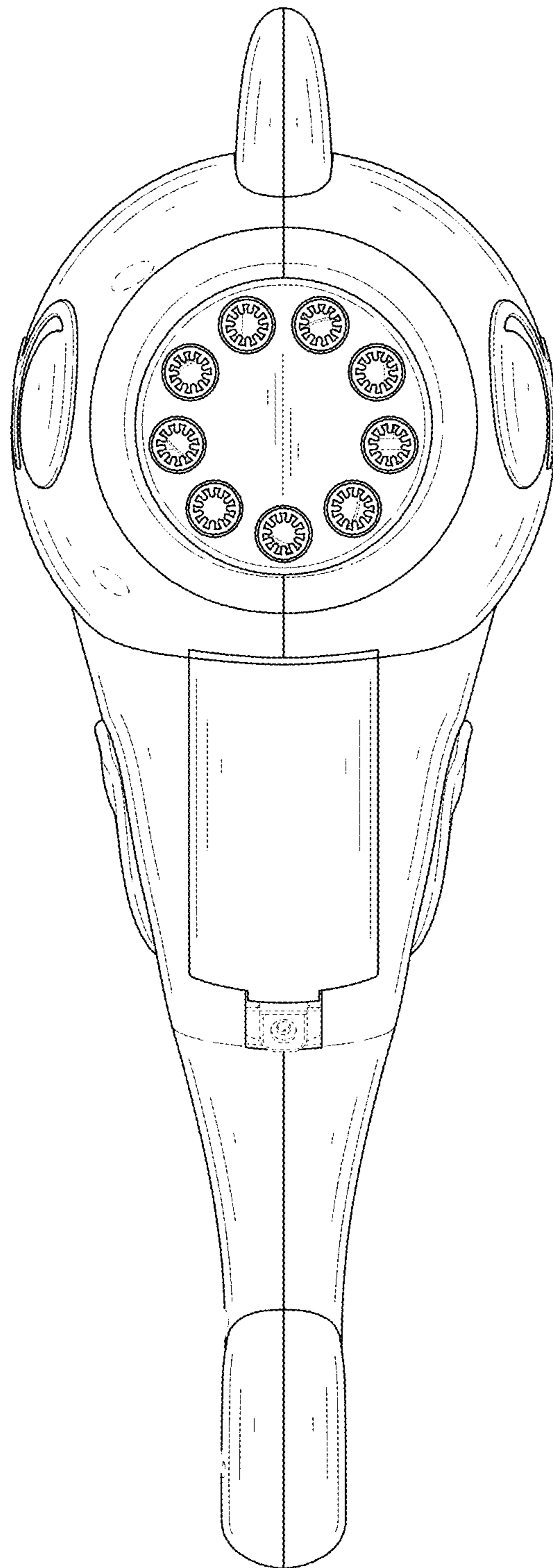

FIG. 3

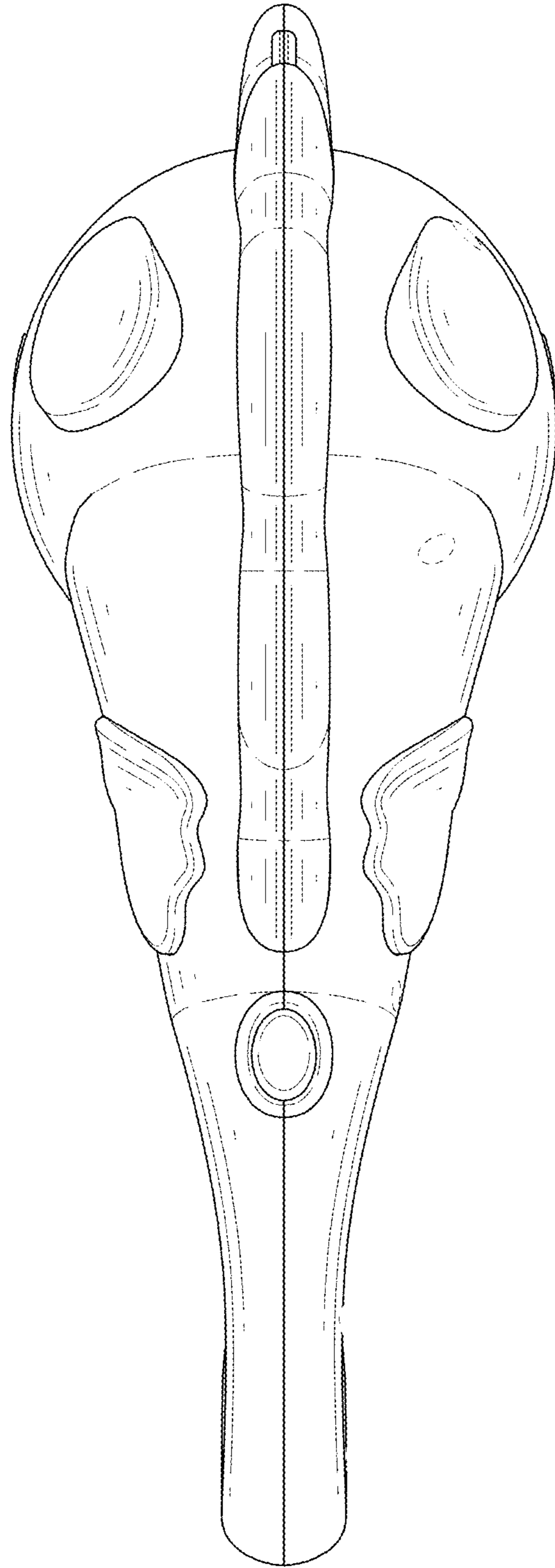

FIG. 4

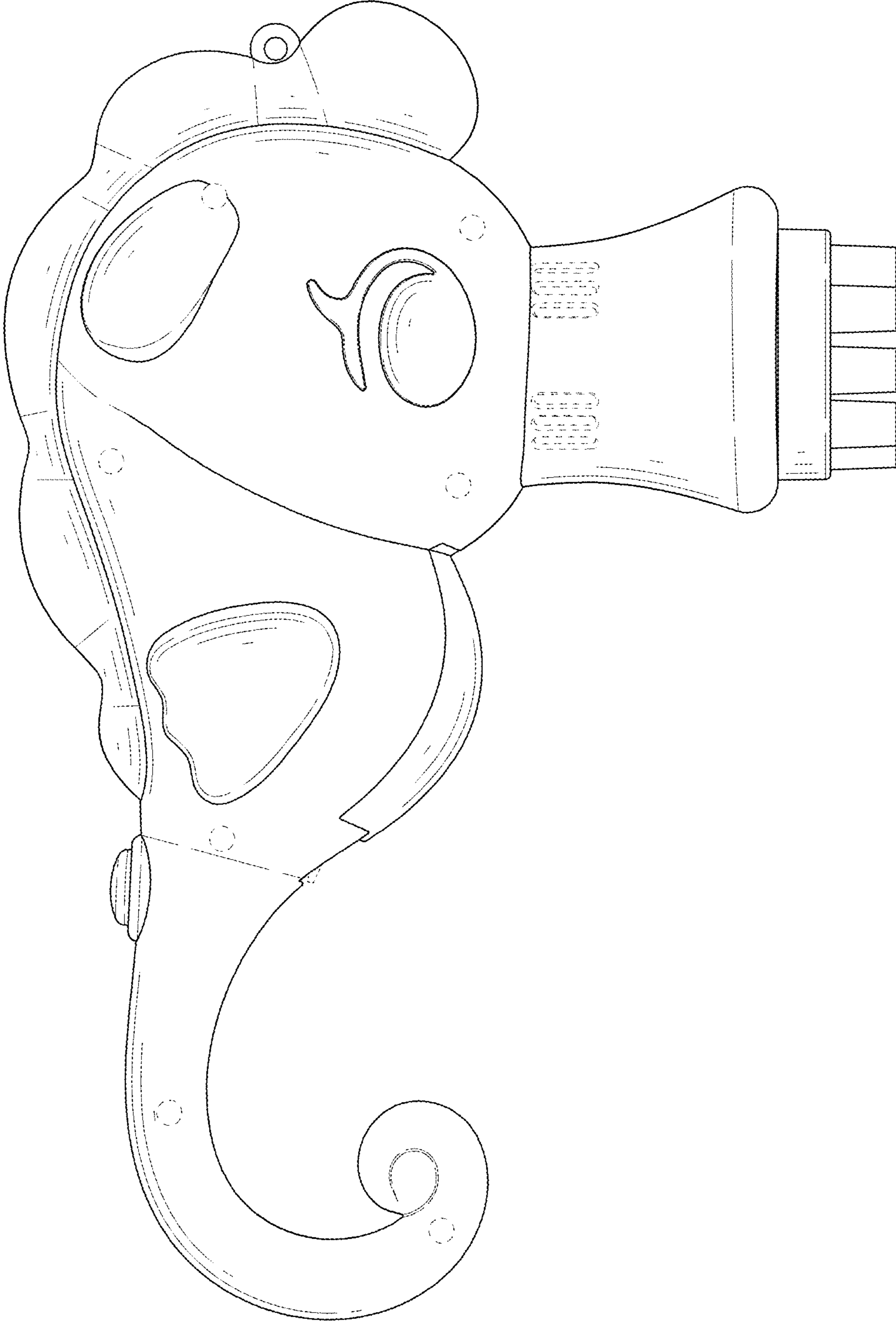

FIG. 5

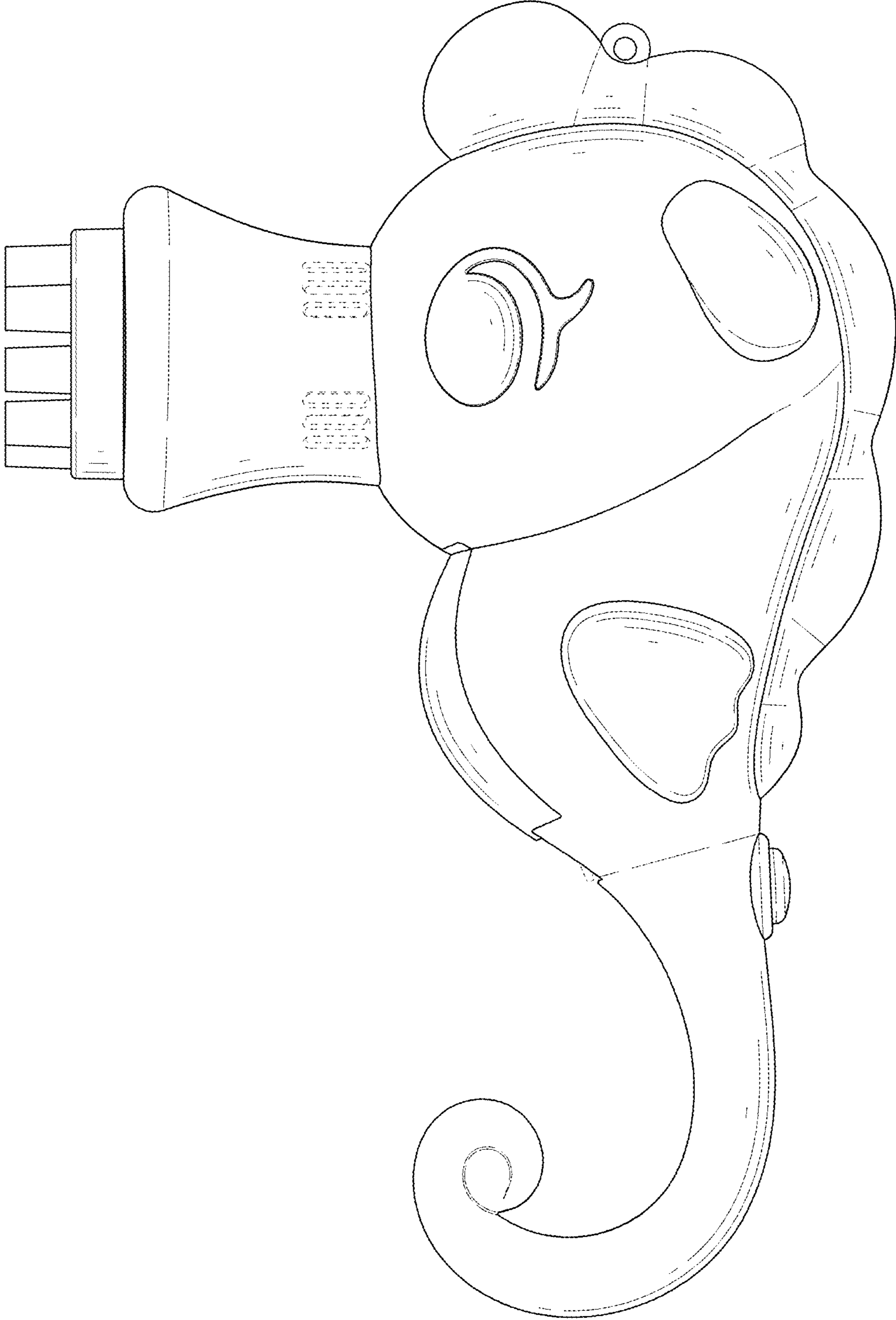

FIG. 6

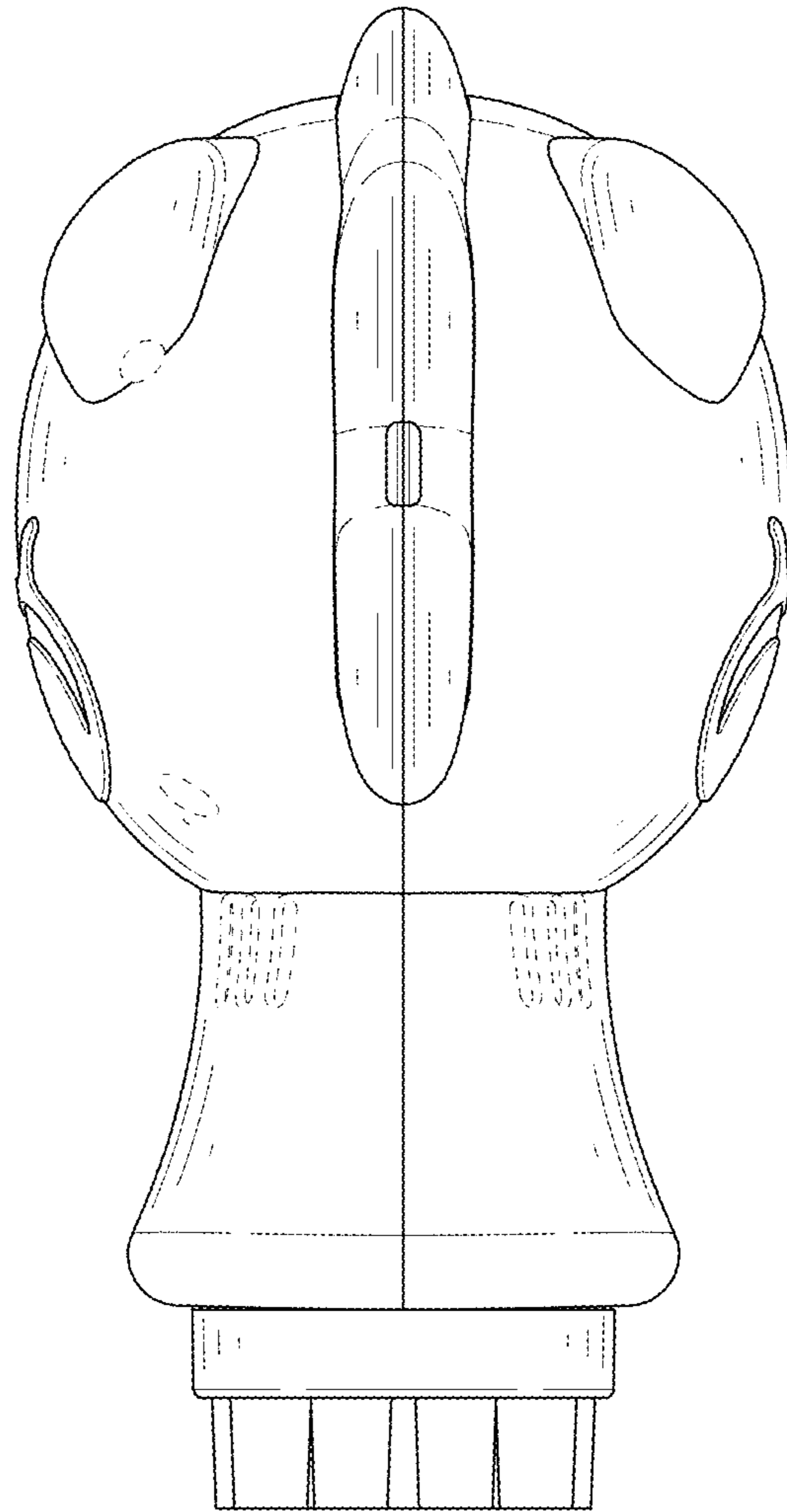

FIG. 7

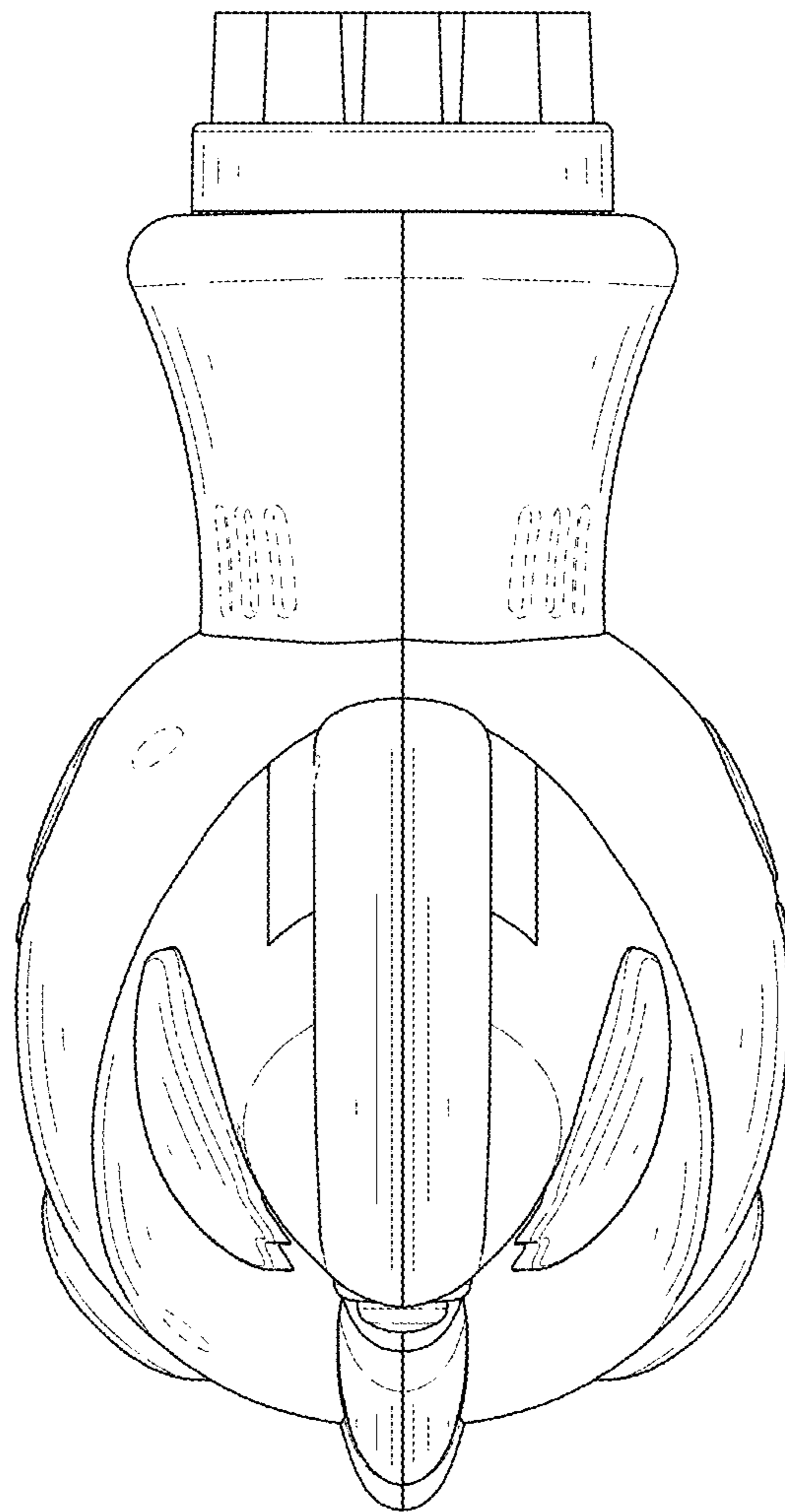

FIG. 8

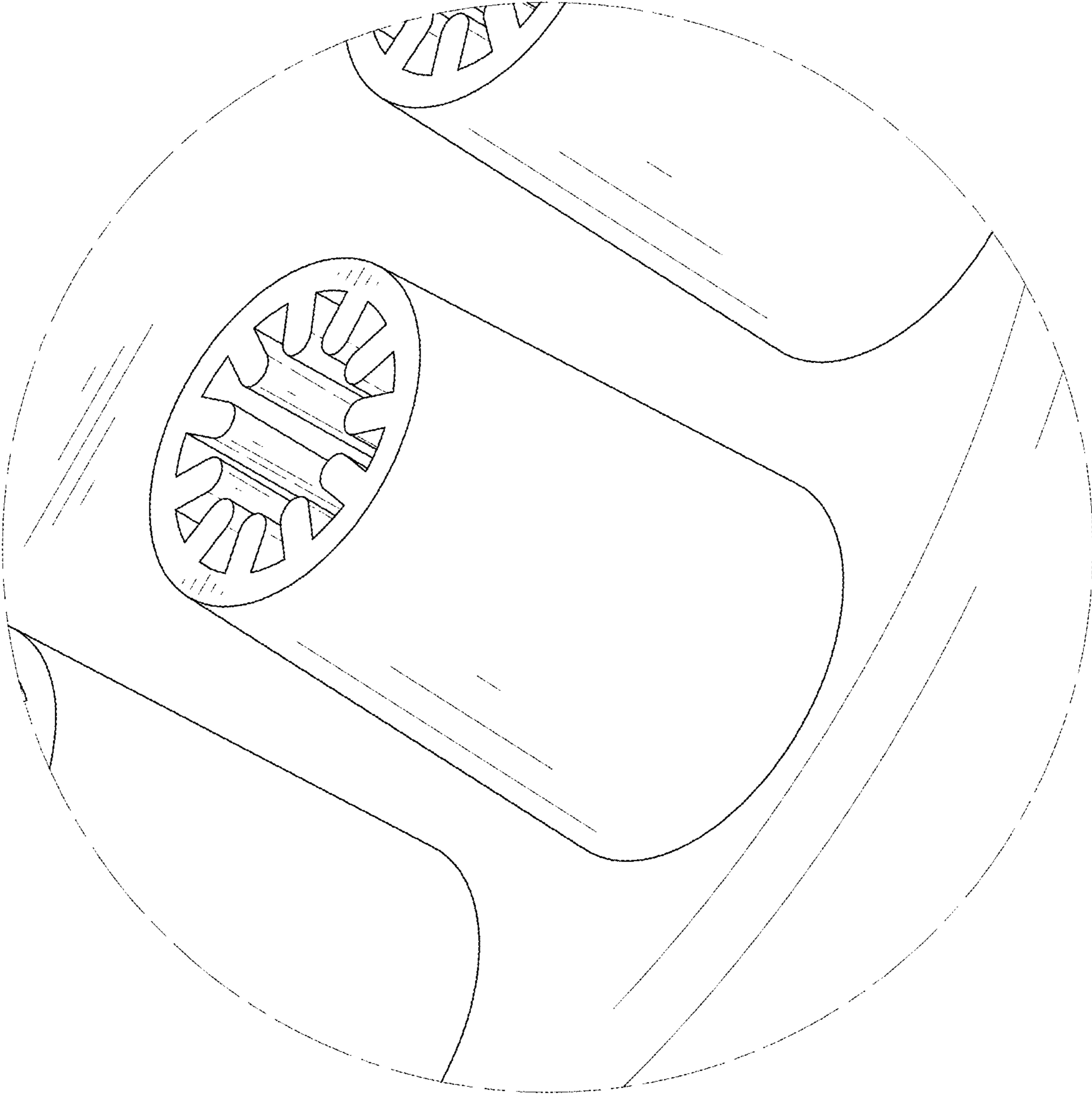

FIG. 9