



US00D937793S

(12) **United States Design Patent** (10) **Patent No.:** **US D937,793 S**
McBride et al. (45) **Date of Patent:** **** Dec. 7, 2021**

(54) **CIRCUIT BOARD**

(71) Applicant: **THE NOCO COMPANY**, Glenwillow, OH (US)

(72) Inventors: **James P. McBride**, Phoenix, AZ (US); **Matthew Michael Bosway**, Gilbert, AZ (US)

(73) Assignee: **THE NOCO COMPANY**, Glenwillow, OH (US)

(**) Term: **15 Years**

(21) Appl. No.: **29/705,008**

(22) Filed: **Sep. 9, 2019**

Related U.S. Application Data

(63) Continuation of application No. 16/564,758, filed on Sep. 9, 2019.

(51) **LOC (13) Cl.** **13-03**

(52) **U.S. Cl.**
USPC **D13/182**

(58) **Field of Classification Search**
USPC D13/182; 361/748, 752, 760, 761, 807, 361/808, 736, 719, 720; 174/250, 253, 174/255, 68.1; 363/144, 147
CPC H05K 3/30; H05K 3/301; H05K 3/284; H05K 3/303; H05K 1/18; H05K 1/181; H05K 1/182; H05K 1/183; H05K 1/185; H05K 1/00; H05K 7/1417; H05K 7/02; H05K 7/12; H05K 7/06; H01L 2924/14
See application file for complete search history.

(56) **References Cited**

U.S. PATENT DOCUMENTS

D327,883 S * 7/1992 Gloton D13/182
D328,599 S * 8/1992 Gloton D13/182

D459,706 S * 7/2002 Ebihara D13/182
D466,093 S * 11/2002 Ebihara D13/182
D471,167 S * 3/2003 Ebihara D13/182
D471,524 S * 3/2003 Ebihara D13/182
D547,371 S * 7/2007 Miller D19/1
D552,098 S * 10/2007 Nishizawa D14/436
D637,193 S * 5/2011 Andre D14/436
D639,756 S * 6/2011 Greene, Jr. D13/182
D642,546 S * 8/2011 Greene, Jr. D13/182
D669,478 S * 10/2012 Lepp D14/436
D669,479 S * 10/2012 Lepp D14/436
D673,921 S * 1/2013 Ozawa D13/182
D673,922 S * 1/2013 Moriai D13/182
D690,672 S * 10/2013 Yoshida D13/182
D734,756 S * 7/2015 Stone D14/436
D735,203 S * 7/2015 Kim D14/436
D735,204 S * 7/2015 Kim D14/436
D736,212 S * 8/2015 Kang D14/436
D736,213 S * 8/2015 Kang D14/436
D736,216 S * 8/2015 Kang D14/436
D739,856 S * 9/2015 Kang D14/436
D757,015 S * 5/2016 Amit D14/435
D759,022 S * 6/2016 Beals D14/436

(Continued)

Primary Examiner — Elizabeth J Oswecki

(74) *Attorney, Agent, or Firm* — Vorys, Sater, Seymour & Pease LLP; William Klima

(57) **CLAIM**

The ornamental design for a circuit board, as shown and described.

DESCRIPTION

FIG. 1 is a perspective view of a circuit board, showing our new design;
FIG. 2 is a front view thereof;
FIG. 3 is a rear view thereof;
FIG. 4 is a top view thereof;
FIG. 5 is a bottom view thereof;
FIG. 6 is a left side view thereof; and,
FIG. 7 is a right side view thereof.

1 Claim, 5 Drawing Sheets

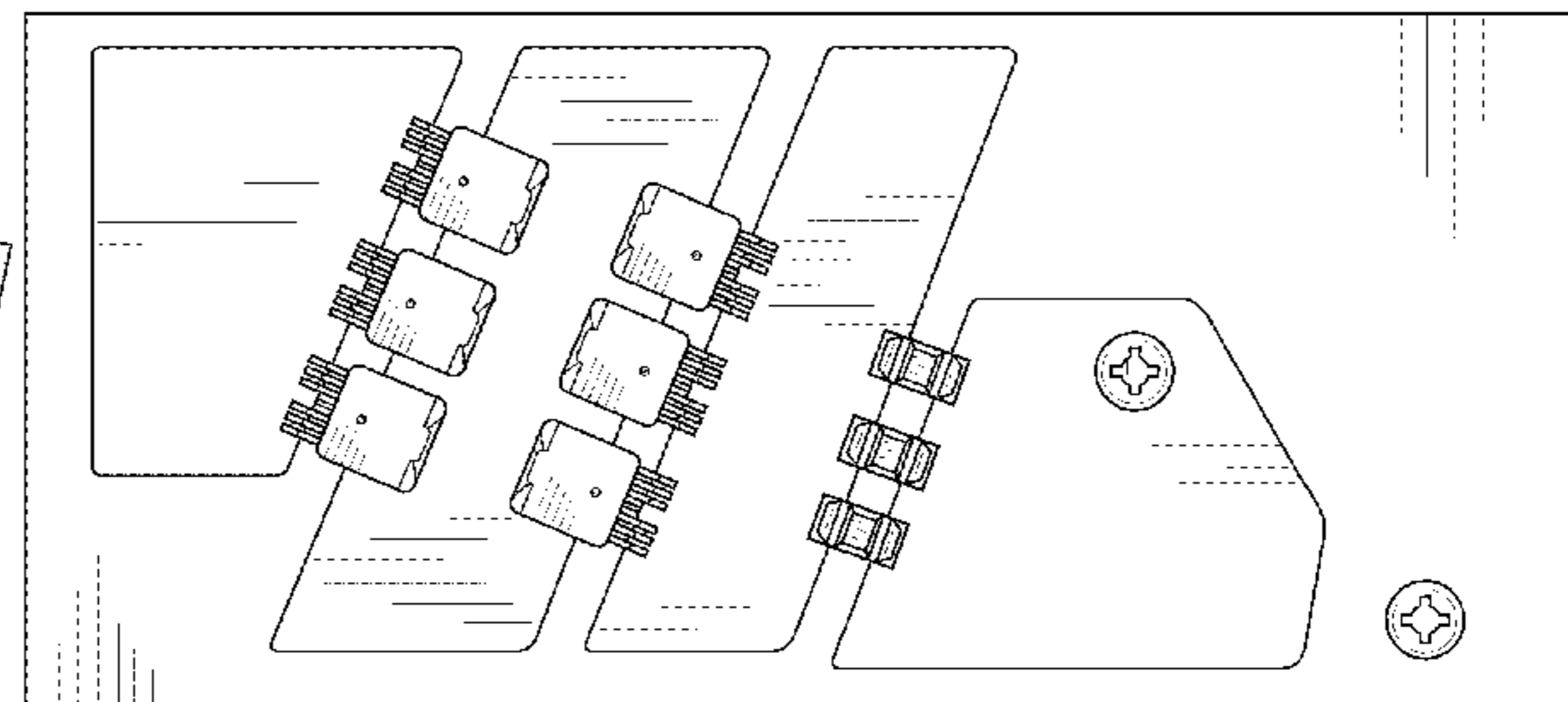
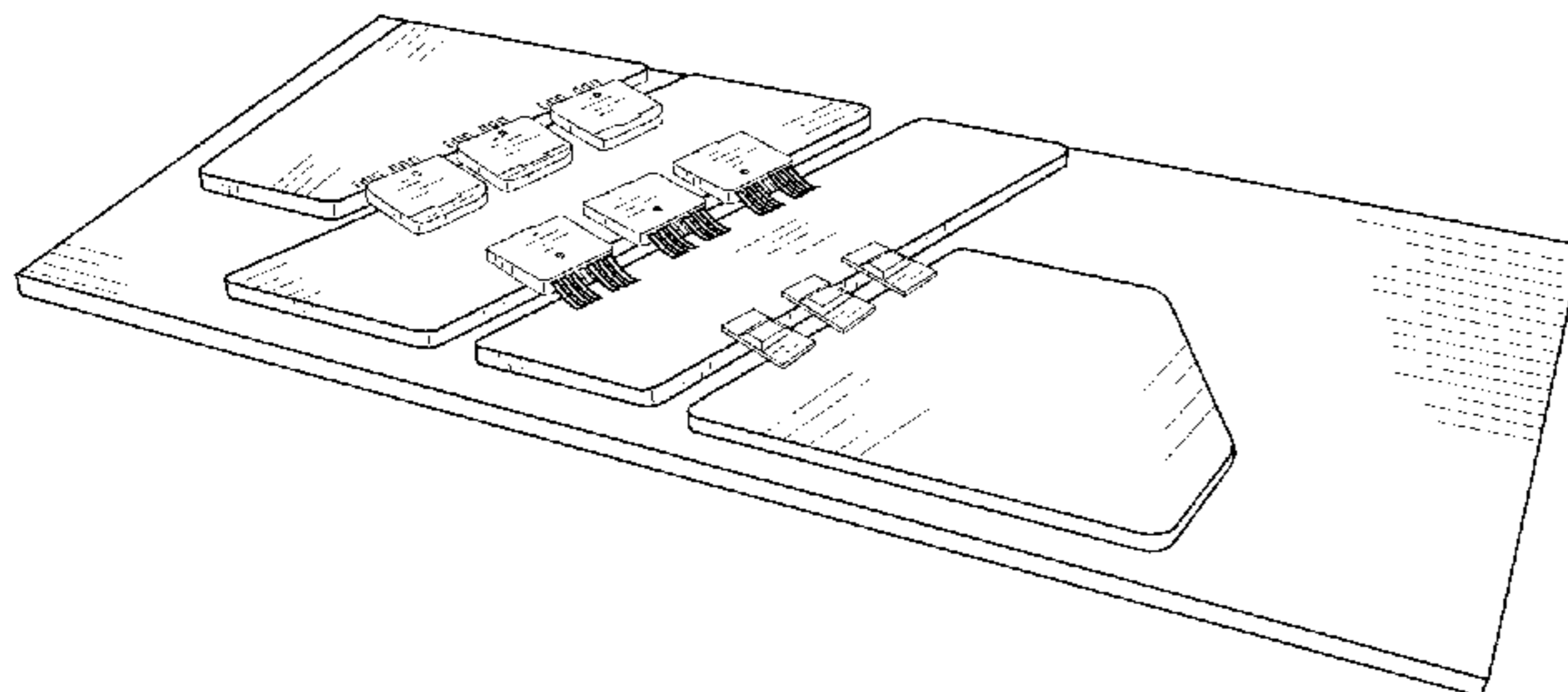

(56)

References Cited

U.S. PATENT DOCUMENTS

D772,232	S *	11/2016	Cho	D14/436
D783,621	S *	4/2017	Lee	D14/436
D813,182	S *	3/2018	Imai	D13/182
D814,473	S *	4/2018	Kadonaga	D14/436
D837,171	S *	1/2019	Vasoya	D13/182
D848,432	S *	5/2019	Lim	D14/436
D856,948	S *	8/2019	Vasoya	D13/182
D864,968	S *	10/2019	Beals	D14/436
D869,469	S *	12/2019	Lim	D14/436
D869,470	S *	12/2019	Lim	D14/436
D872,032	S *	1/2020	Morelli	D13/147
D872,033	S *	1/2020	Morelli	D13/147
D893,439	S *	8/2020	Vasoya	D13/182
D902,164	S *	11/2020	Kondo	D13/182
D909,319	S *	2/2021	Nordeen	D13/182
2003/0081387	A1 *	5/2003	Schulz	H05K 1/117 361/728
2006/0097374	A1 *	5/2006	Egawa	H01L 24/05 257/686
2009/0268390	A1 *	10/2009	King	G06F 13/409 361/679.33

* cited by examiner

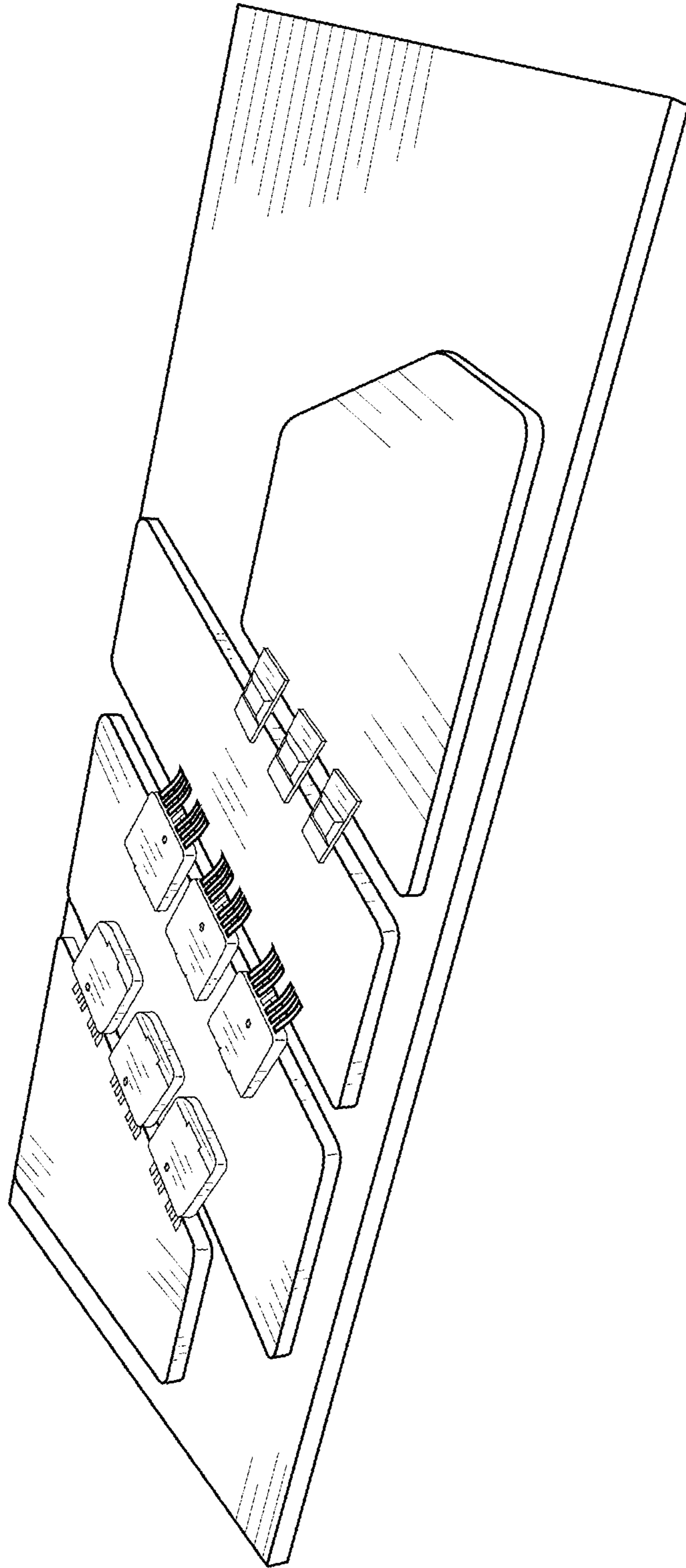

FIG. 1

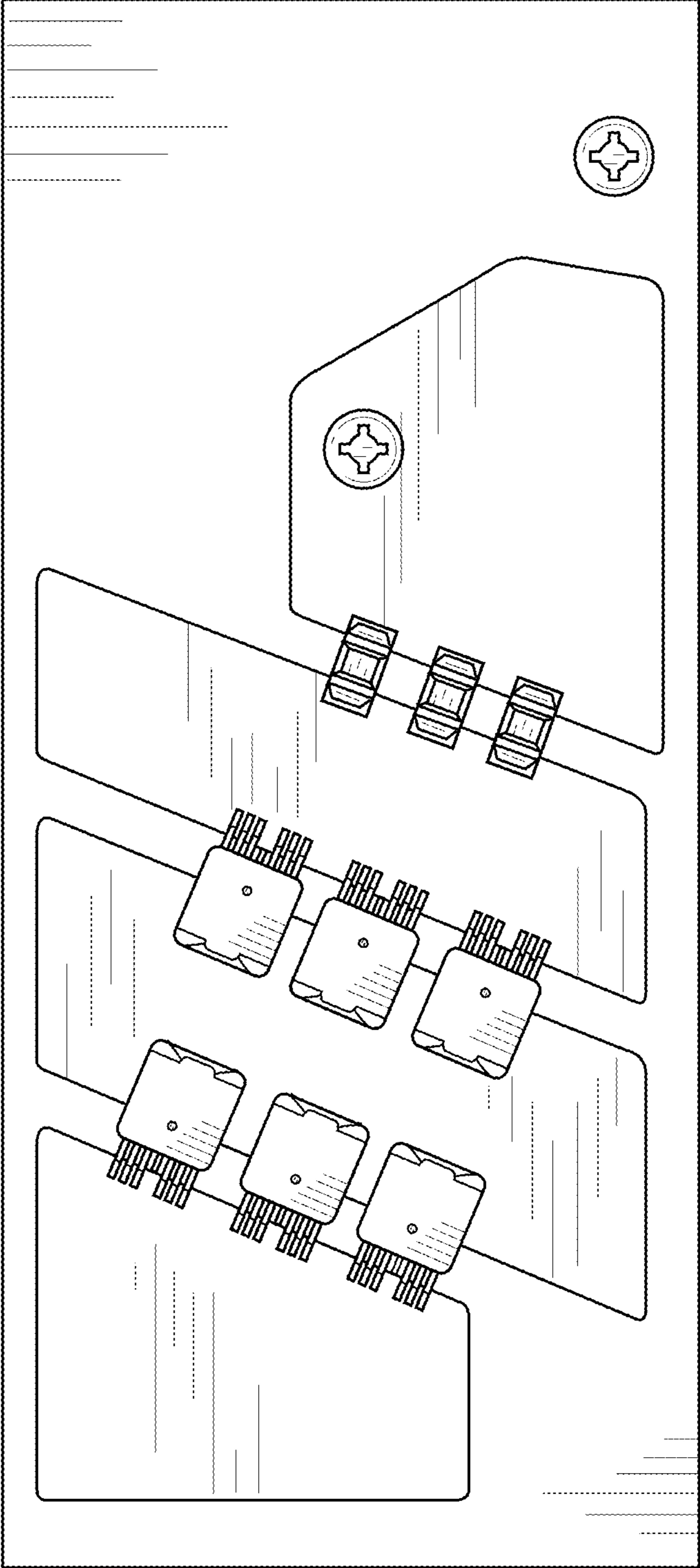

FIG. 2

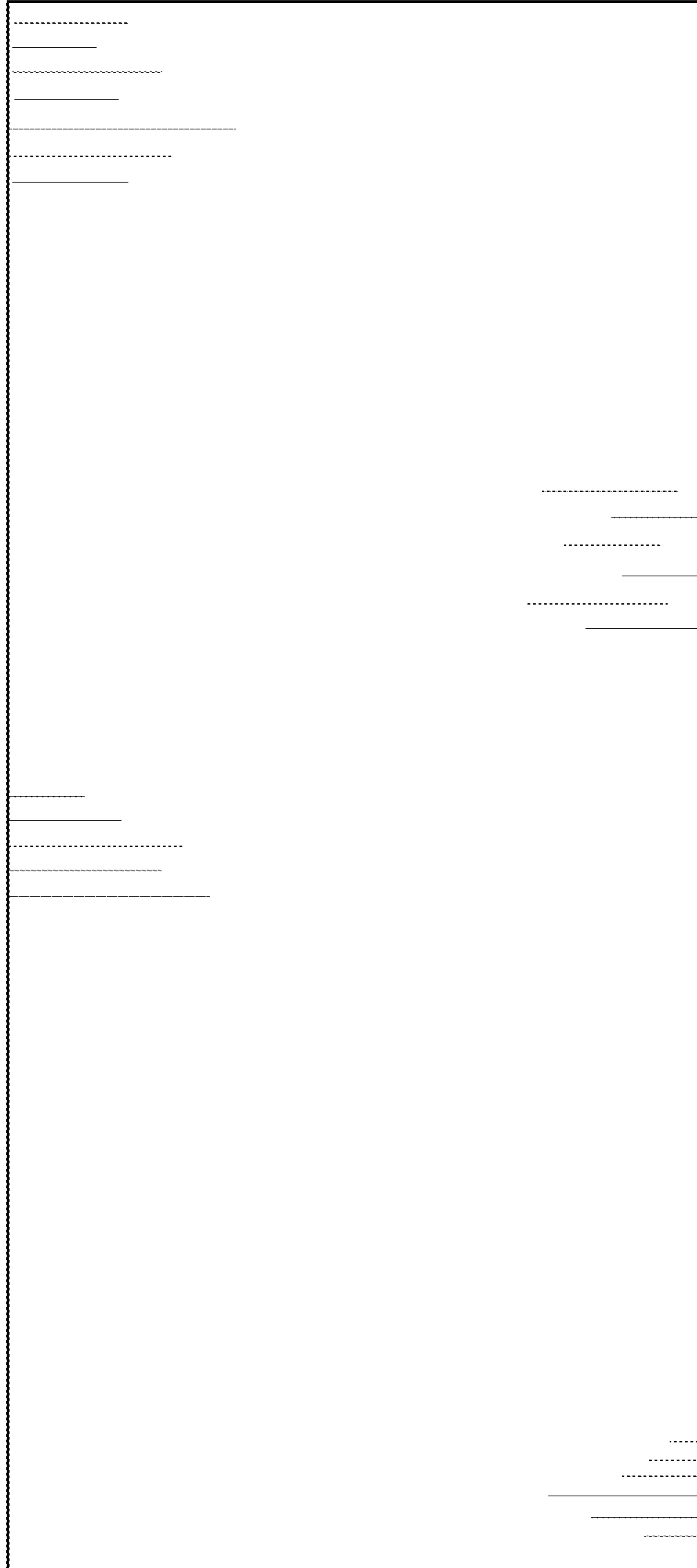

FIG. 3

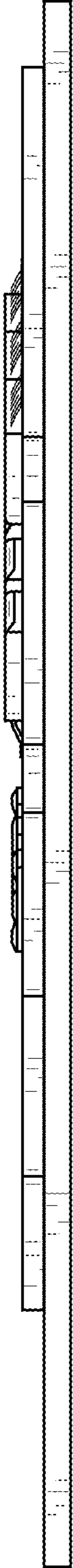

FIG. 4

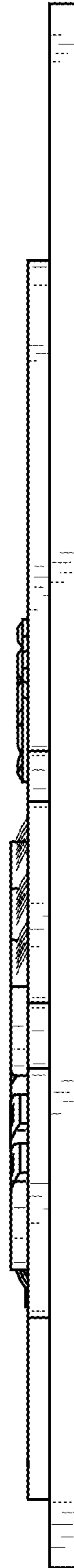

FIG. 5

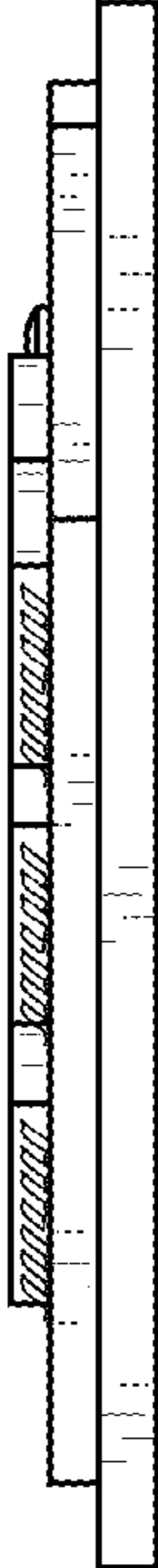

FIG. 6

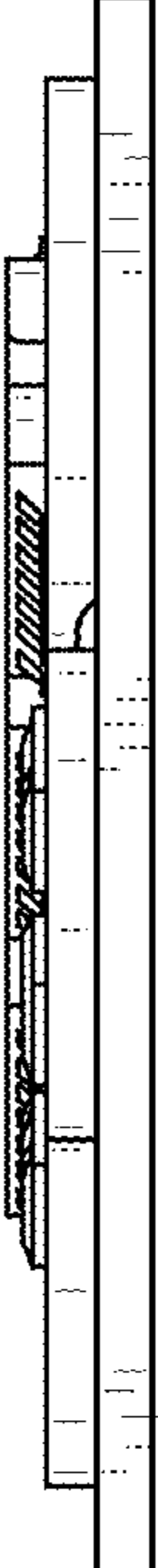

FIG. 7