



US00D937673S

(12) **United States Design Patent** (10) **Patent No.:** **US D937,673 S**
Rosendall et al. (45) **Date of Patent:** **** Dec. 7, 2021**

(54) **PACKAGE**

- (71) Applicant: **MARS, INCORPORATED**, McLean, VA (US)
- (72) Inventors: **Eric Rosendall**, Lansing, MI (US); **Jen Coniglio**, Chicago, IL (US); **Rich Funk**, Park Ridge, IL (US)
- (73) Assignee: **MARS, INCORPORATED**, McLean, VA (US)
- (**) Term: **15 Years**

(21) Appl. No.: **29/716,839**

(22) Filed: **Dec. 12, 2019**

(51) **LOC (13) Cl.** **09-03**

(52) **U.S. Cl.**
USPC **D9/432**

(58) **Field of Classification Search**

USPC D9/414-420, 421-433, 434, 442, 445, D9/456, 542, 563, 600, 614-624, 707, D9/708, 711, 754, 759; D3/273, 276, D3/304, 309-313; D7/601, 602, 709

CPC B65D 5/00; B65D 5/001; B65D 5/0027; B65D 5/0254; B65D 5/18; B65D 5/38; B65D 5/40; B65D 5/2033; B65D 5/48024; B65D 5/6605; B65D 1/22; B65D 1/24; B65D 1/34; B65D 50/04; B65D 5/5021; B65D 85/30; B65D 50/045; B65B 5/06

See application file for complete search history.

(56) **References Cited**

U.S. PATENT DOCUMENTS

- 2,132,957 A * 10/1938 Mahone B65D 5/2004
229/125.125
- D126,123 S * 3/1941 Clemens D9/418
(Continued)

OTHER PUBLICATIONS

Exclusive to Festival Foods: Green and Gold Packers M&Ms. Online, published date Aug. 30, 2019. Retrieved on Apr. 20, 2021 from URL: <https://www.festfoods.com/blog/exclusive-to-festival-foods-green-and-gold-packers-mms> (Year: 2021).*

(Continued)

Primary Examiner — Michael C Stout
Assistant Examiner — Omeed Agilee

(57) **CLAIM**

We claim the ornamental design for a package, as substantially shown and described.

DESCRIPTION

FIG. 1 is an elevated perspective view of a package showing the sleeve;

FIG. 2 is a front elevation view thereof;

FIG. 3 is a rear elevation view thereof;

FIG. 4 is a right side elevation view thereof;

FIG. 5 is a left side elevation view thereof;

FIG. 6 is a top plan view thereof;

FIG. 7 is a bottom plan view thereof;

FIG. 8 is an elevated perspective view of the package showing the tray;

FIG. 9 is a front elevation view thereof;

FIG. 10 is a rear elevation view thereof;

FIG. 11 is a right side elevation view thereof;

FIG. 12 is a left side elevation view thereof;

FIG. 13 is a top plan view thereof;

FIG. 14 is a bottom plan view thereof;

FIG. 15 is an elevated view of the package showing the tray and the sleeve together; and,

FIG. 16 is an elevated exploded view thereof.

The broken lines in FIGS. 1-5 and FIGS. 8-12 depict portions of the package that form no part of the claimed design. The broken line showing of a bag (filled with circular items) in FIGS. 15 and 16 illustrates environmental subject matter and forms no part of the claimed design.

1 Claim, 12 Drawing Sheets

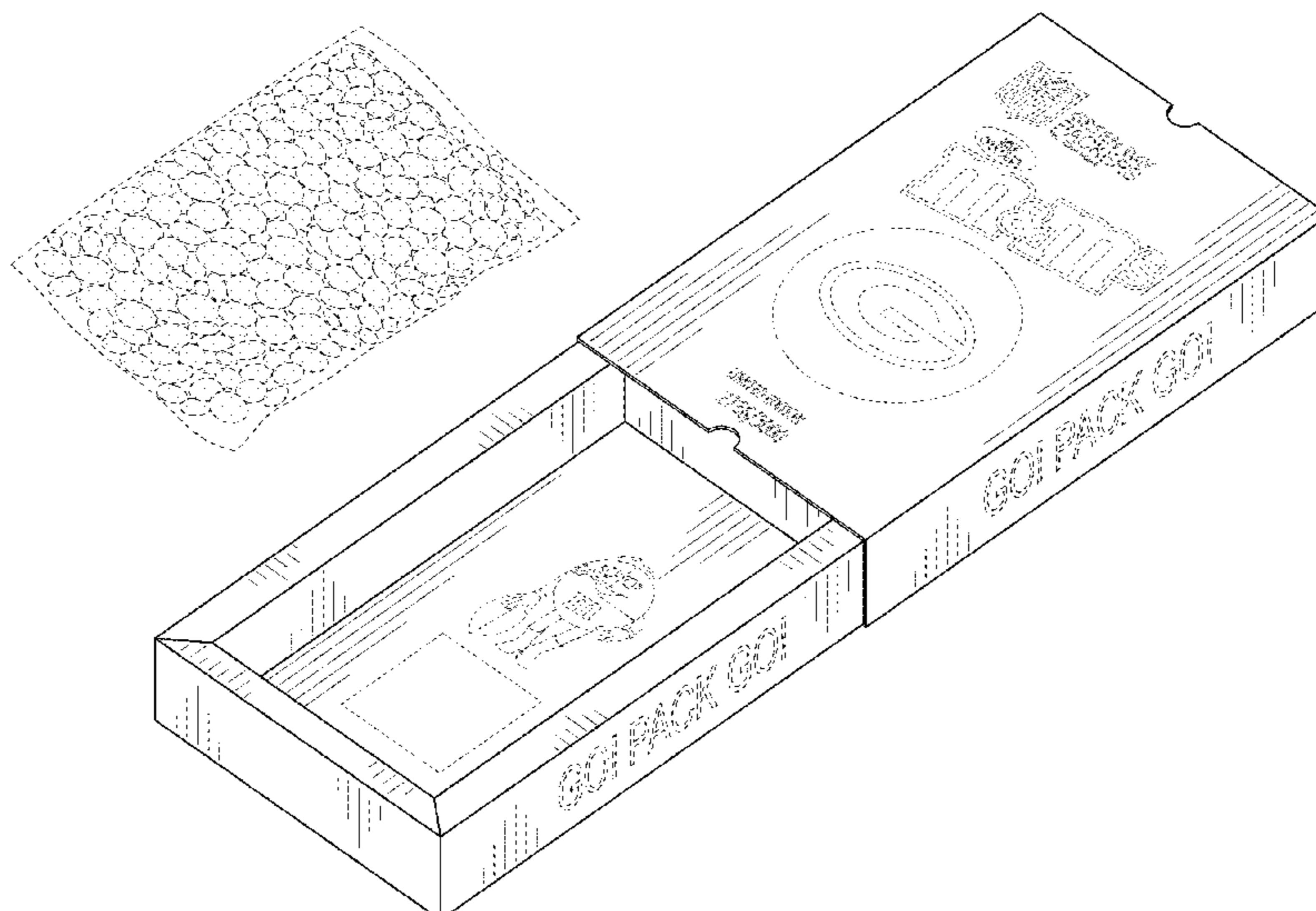

(56)

References Cited

U.S. PATENT DOCUMENTS

2,430,609 A * 11/1947 Guyer B65D 5/52
229/122.29
3,371,843 A * 3/1968 Hailey B65D 5/2009
229/167
3,395,849 A * 8/1968 Gillam B65D 5/38
229/125.125
3,905,543 A * 9/1975 Randles B65D 5/2009
229/161
D576,873 S * 9/2008 Kim D9/418
D621,703 S * 8/2010 Hageman D9/432
D720,614 S * 1/2015 Kim D9/432
9,738,412 B1 * 8/2017 Victor A24F 27/00
D883,802 S * 5/2020 Meech D9/748
D899,247 S * 10/2020 Kilduff D9/432
D910,439 S * 2/2021 Kelly D9/432
D913,785 S * 3/2021 Kelly D9/432
2007/0251983 A1 * 11/2007 Freeze B65D 5/38
229/125.125

2016/0114965 A1 * 4/2016 Huang B65D 5/48022
206/472
2019/0062023 A1 * 2/2019 Lantz B65D 5/38
2020/0140157 A1 * 5/2020 Pai B65D 5/643
2021/0016939 A1 * 1/2021 Palmer B65D 50/045

OTHER PUBLICATIONS

NBEADS Box Rectangle Burlywood Cardboard Bead Paper Gift Drawer Box for Jewellery Bracelet Necklace Crafts Birthday Christmas Festival Present Bangle Storage. Online, published date May 2, 2019. Retrieved on Apr. 20, 2021 from URL: <https://www.amazon.co.uk/NBEADS-Rectangle-Burly> (Year: 2019).*
XLPD 100Pcs/Lot 10 Sizes White/Black/Kraft Paper Gift Box Small/Large Kraft Paper Drawer Box, Paper Gift Cardboard Boxes White Color 8x8x4cm. Online, published date unknown. Retrieved on Apr. 20, 2021 from URL: <https://www.amazon.com/XLPD-100Pcs-Drawer-Cardboard-8x8x4cm/dp/B07JJGD5L7> (Year: 2021).*

* cited by examiner

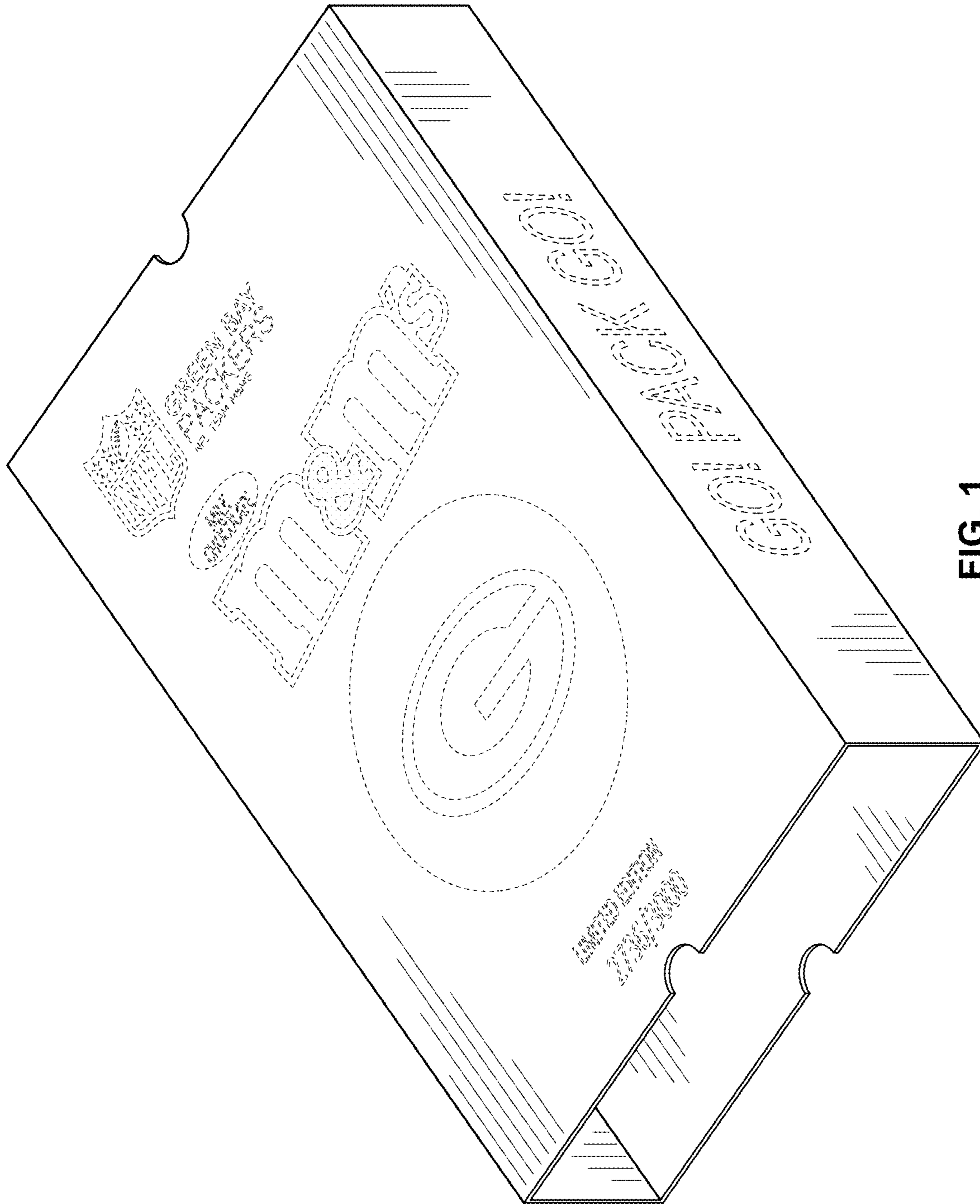

FIG. 1

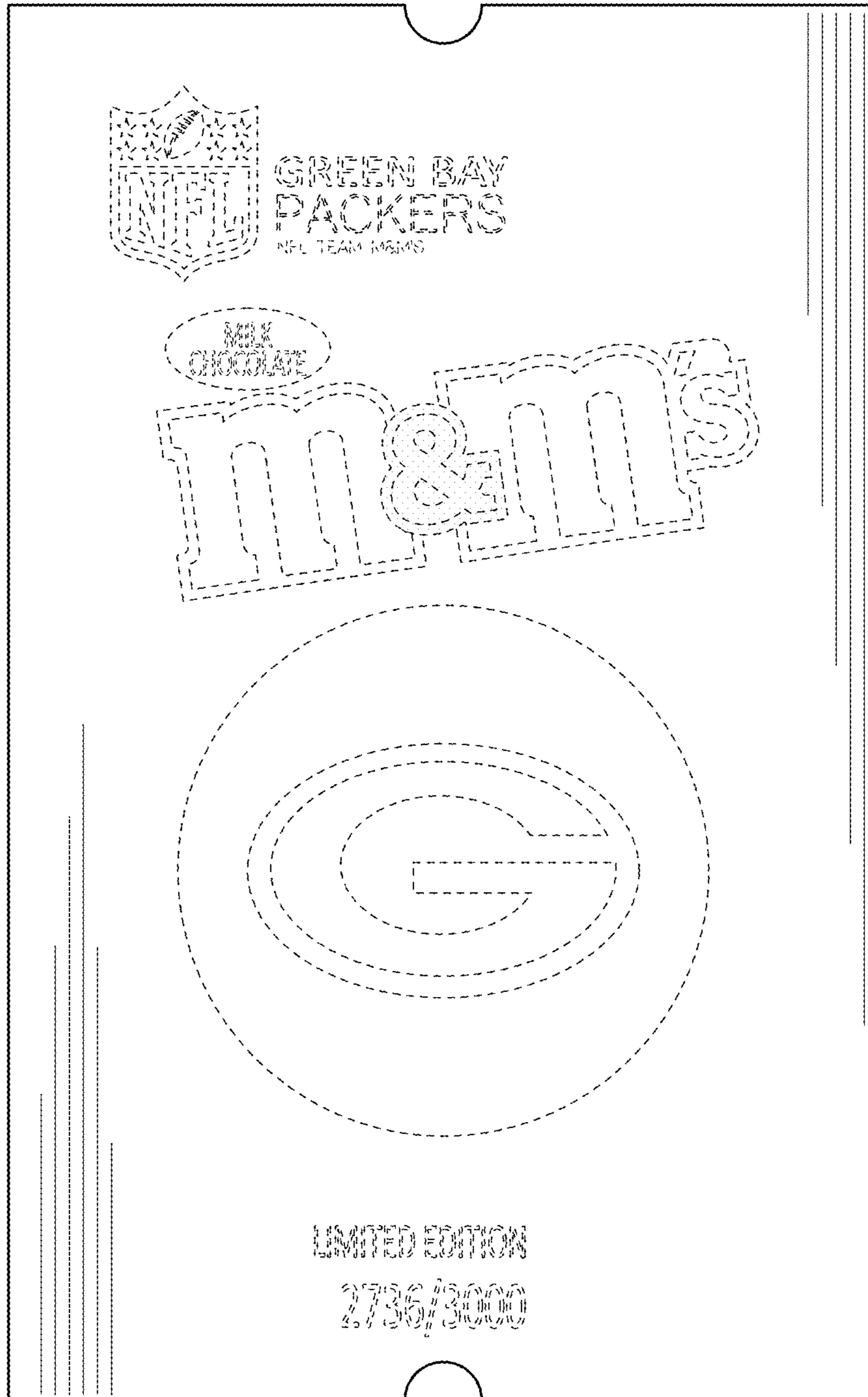

FIG. 2

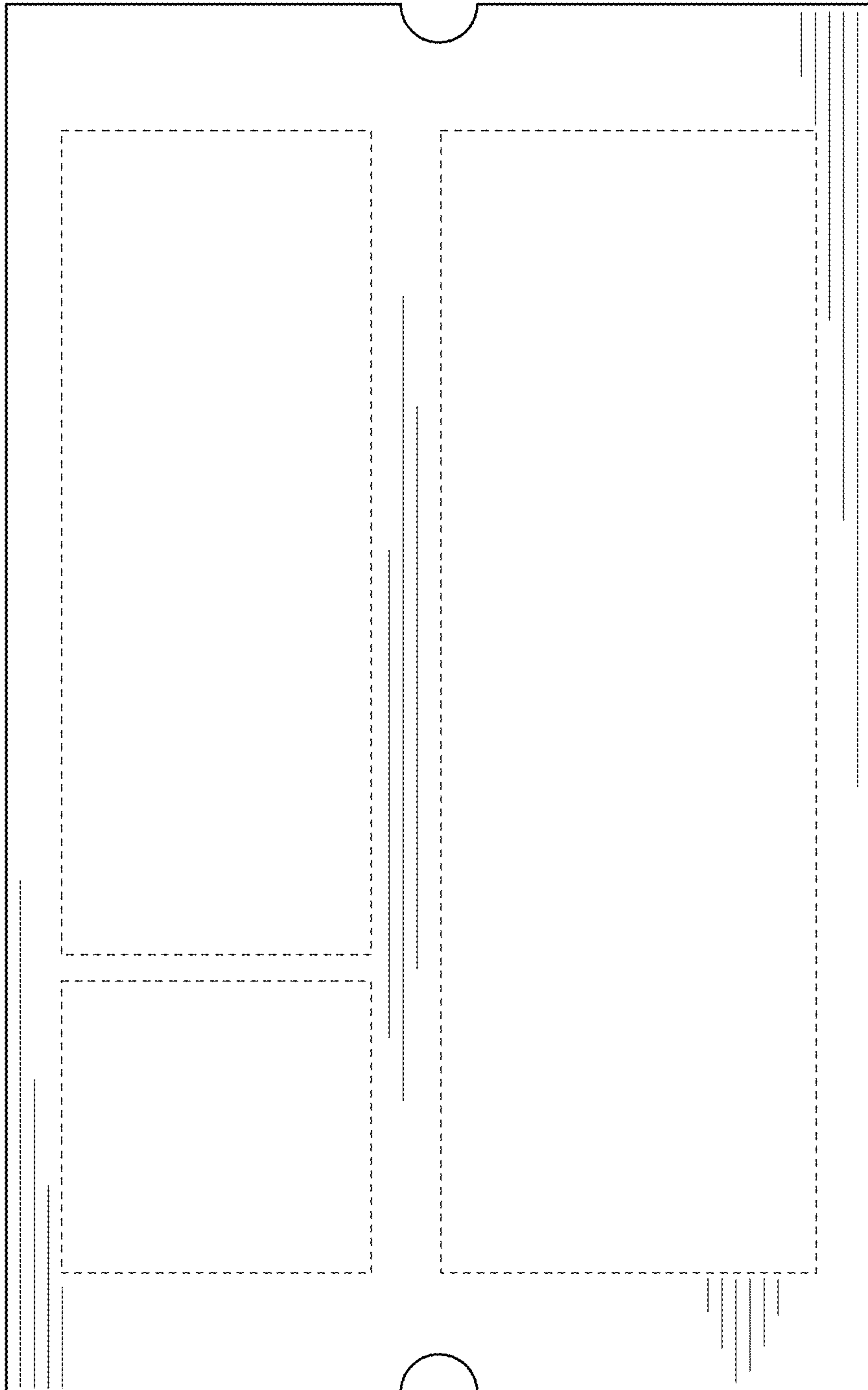

FIG. 3

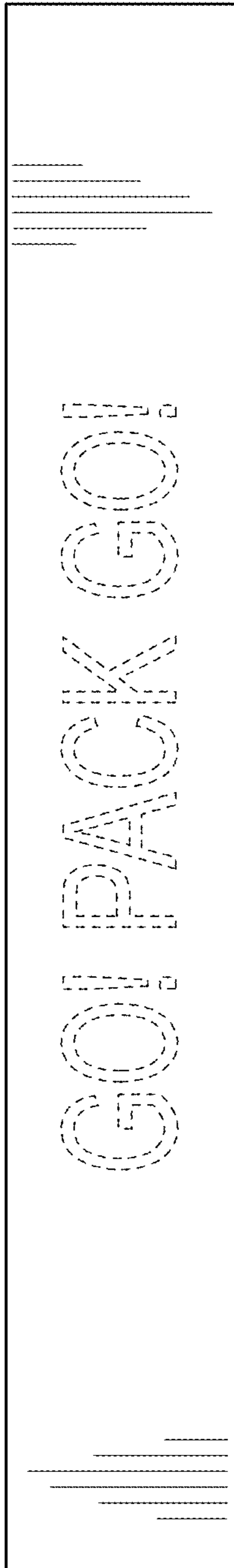

FIG. 4

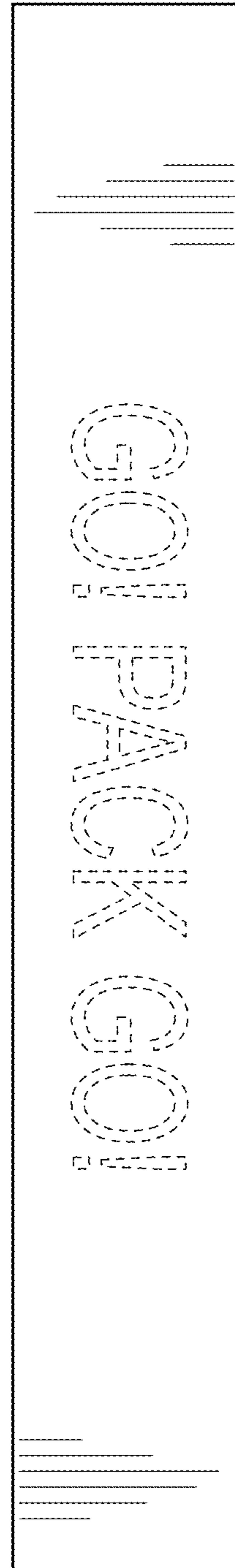

FIG. 5



FIG. 6

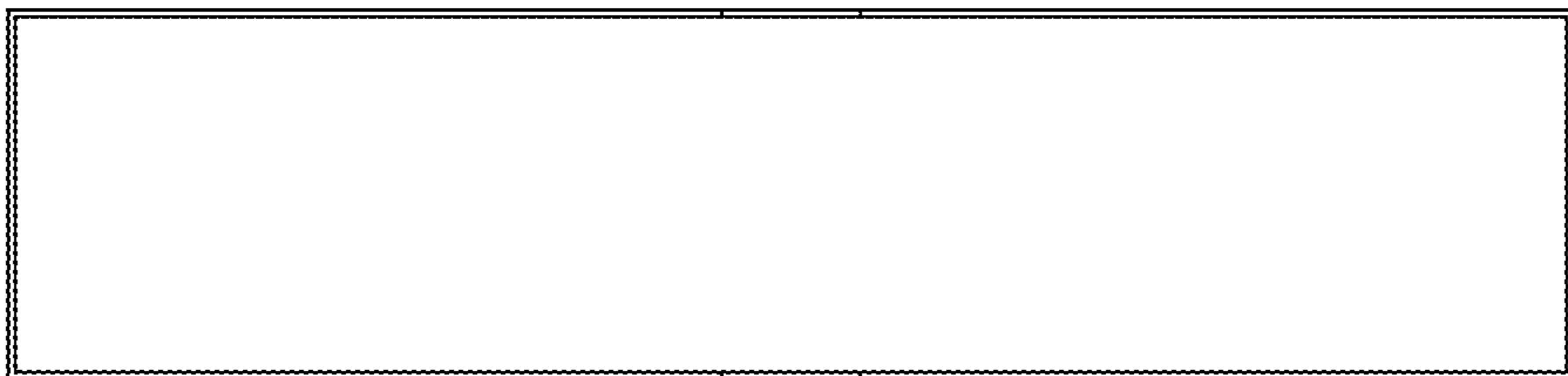

FIG. 7

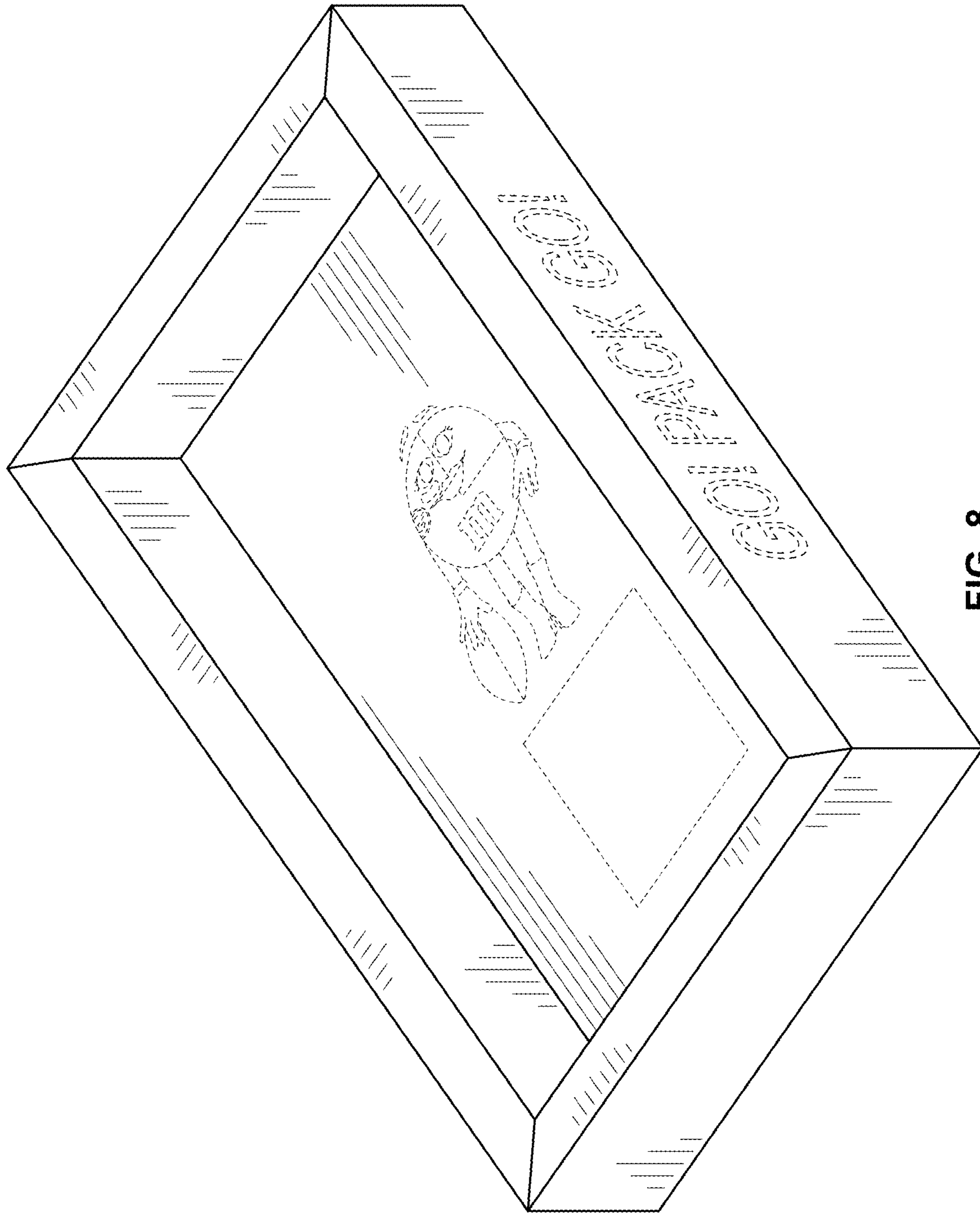

FIG. 8

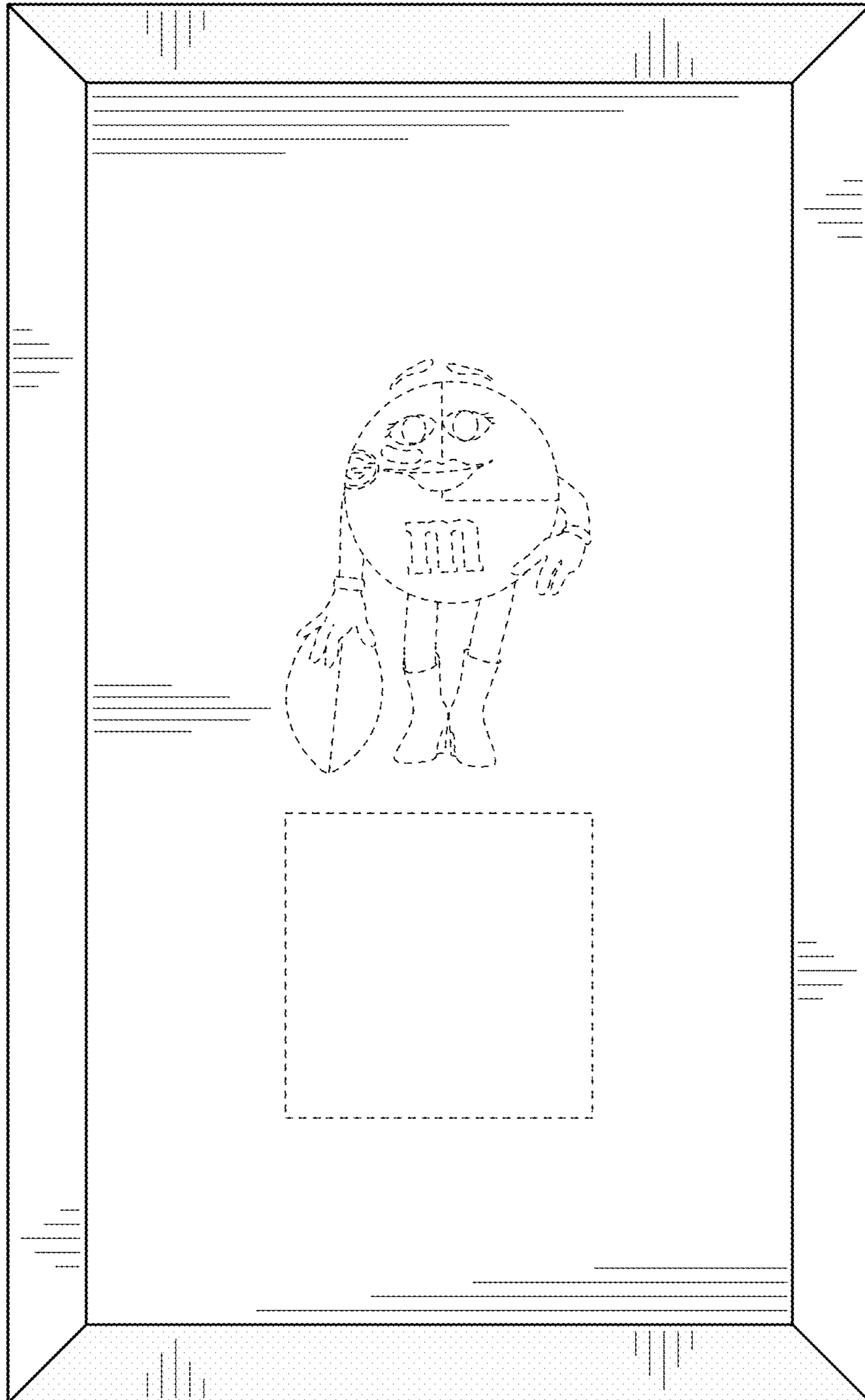

FIG. 9



FIG. 10

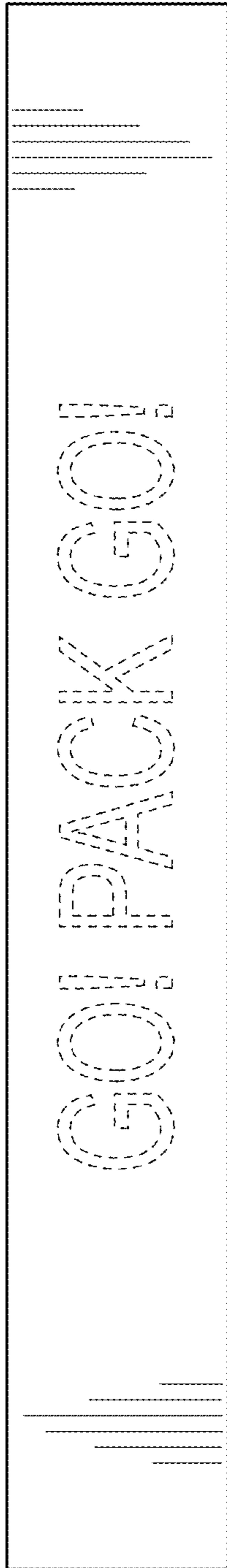

FIG. 11

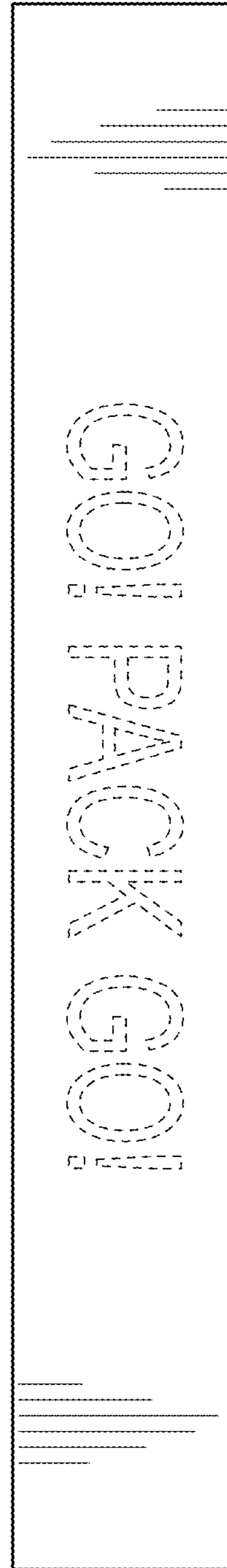

FIG. 12

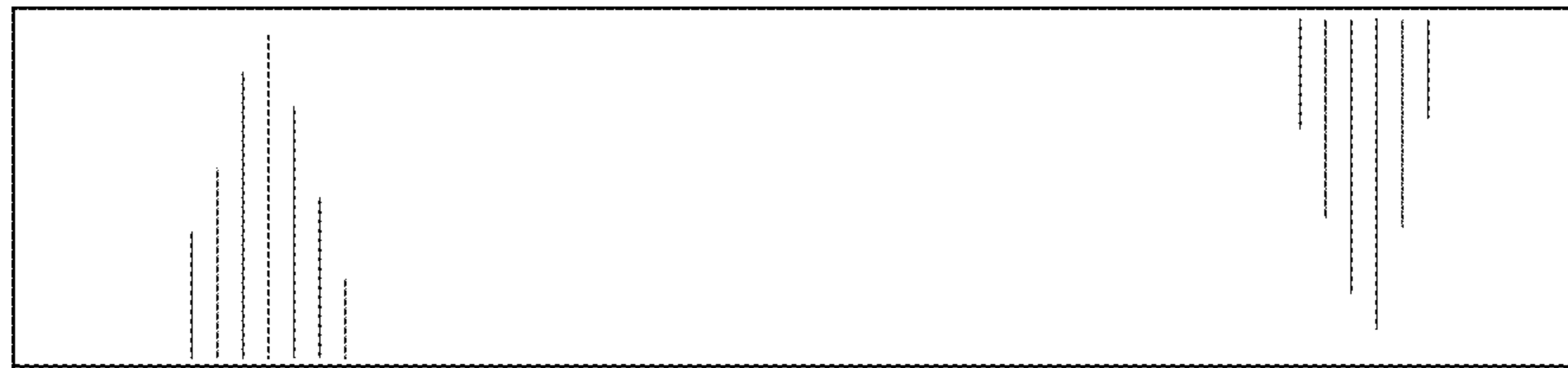

FIG. 13



FIG. 14

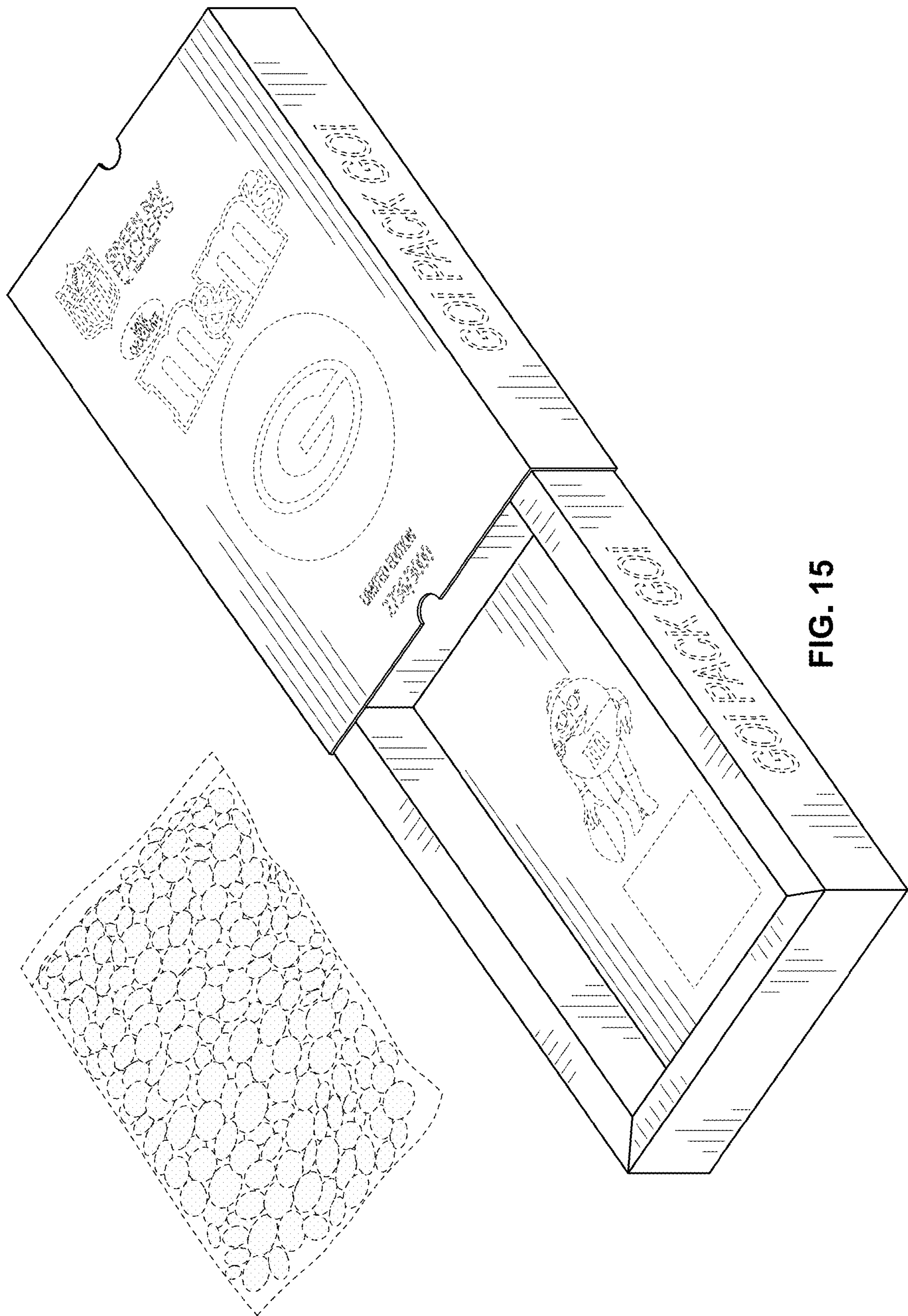

FIG. 15

