

US00D937614S

(12) **United States Design Patent** (10) **Patent No.:** **US D937,614 S**
Dejesus et al. (45) **Date of Patent:** **** *Dec. 7, 2021**

(54) **RETAIL FIXTURE**

FOREIGN PATENT DOCUMENTS

(71) Applicant: **Apple Inc.**, Cupertino, CA (US)

KR 30-0703066 7/2013

(72) Inventors: **Manuel Dejesus**, San Francisco, CA (US); **Joshua Robert Edwards**, Santa Cruz, CA (US); **Jean-Marc Gady**, Los Altos, CA (US); **Wesley Bryan Hamm**, San Francisco, CA (US); **Russell John Kaaihue Heirakuji**, Cupertino, CA (US); **Allison Inouye**, San Francisco, CA (US); **Moritz Wilsberg**, Rheinbreitbach (DE)

Primary Examiner — Kelley A Donnelly
(74) *Attorney, Agent, or Firm* — Sterne, Kessler, Goldstein & Fox P.L.L.C.

(57) **CLAIM**

The ornamental design for a retail fixture, as shown and described.

(73) Assignee: **Apple Inc.**, Cupertino, CA (US)

DESCRIPTION

(*) Notice: This patent is subject to a terminal disclaimer.

(**) Term: **15 Years**

The file of this patent contains at least one drawing/photograph executed in color. Copies of this patent with color drawing(s)/photograph(s) will be provided by the Office upon request and payment of the necessary fee.

(21) Appl. No.: **29/780,929**

FIG. 1 is a top front perspective view of a retail fixture showing the claimed design;

(22) Filed: **Apr. 27, 2021**

FIG. 2 is a front view thereof;

Related U.S. Application Data

(63) Continuation of application No. 29/741,447, filed on Jul. 13, 2020, now Pat. No. Des. 917,937, which is a (Continued)

FIG. 3 is a rear view thereof;

(51) **LOC (13) Cl.** **06-06**

(52) **U.S. Cl.**
USPC **D6/675**

FIG. 4 is a left side view thereof;

(58) **Field of Classification Search**
USPC D6/672, 675, 675.1, 678, 678.1, 682, D6/682.3, 682.4, 683, 683.1
(Continued)

FIG. 5 is a right side view thereof;

FIG. 6 is a top view thereof;

FIG. 7 is a bottom view thereof;

FIG. 8 is a top front perspective view of a retail fixture showing the claimed design;

FIG. 9 is a front view thereof;

FIG. 10 is a rear view thereof;

FIG. 11 is a left side view thereof;

FIG. 12 is a right side view thereof;

FIG. 13 is a top view thereof; and,

FIG. 14 is a bottom view thereof.

The dashed broken lines in the figures show portions of the retail fixture that form no part of the claimed design.

FIGS. 1-7 and 8-14 are illustrated to show color. The colored portions and the white claimed portions of the retail fixture have an appearance as shown. The appearance of the white unclaimed portions of the retail fixture forms no part of the claimed design.

(56) **References Cited**

U.S. PATENT DOCUMENTS

D248,345 S 7/1978 Stoddard
D274,203 S 6/1984 Everett

(Continued)

(Continued)

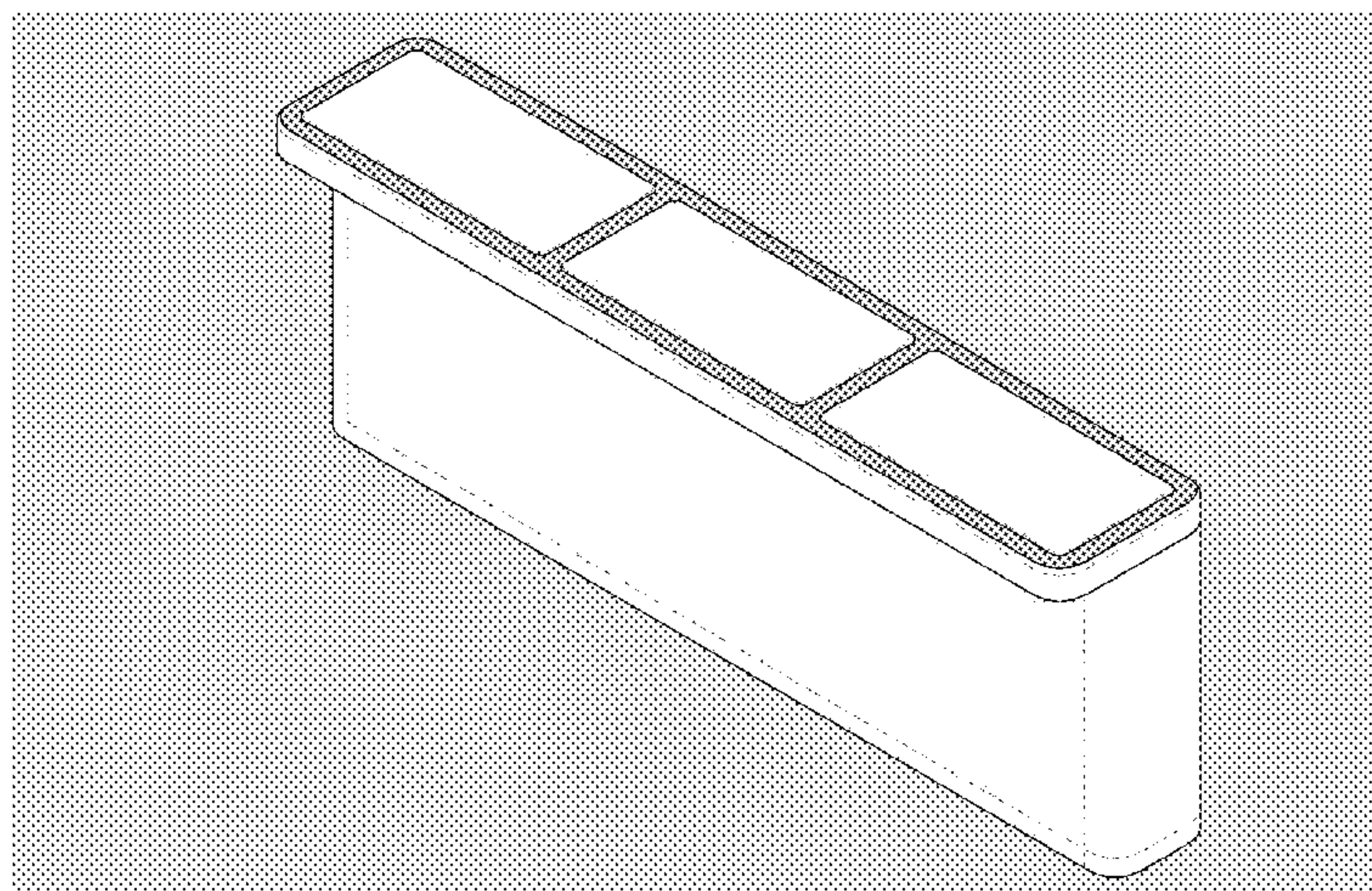

The gray background in FIGS. 1-7 and 8-14 is used to better illustrate the colored appearance of the retail fixture. The gray background itself forms no part of the claimed design.

**1 Claim, 14 Drawing Sheets
(4 of 14 Drawing Sheet(s) Filed in Color)**

Related U.S. Application Data

continuation of application No. 29/655,967, filed on Jul. 9, 2018, now Pat. No. Des. 889,887.

- (58) **Field of Classification Search**
 CPC A47B 73/00; A47B 73/002; A47B 47/00;
 A47B 47/008; A47B 47/25; A47F 5/00;
 A47F 5/0062

See application file for complete search history.

- (56) **References Cited**

U.S. PATENT DOCUMENTS

D300,966 S	5/1989	Colby
D303,190 S	9/1989	Suttles
4,886,327 A	12/1989	Amstutz et al.
D305,286 S	1/1990	Otema
D347,755 S	6/1994	Houston
D406,964 S	3/1999	Lewis
D427,814 S	7/2000	Black
D427,815 S	7/2000	Lewis
D465,936 S	11/2002	Arnold
D466,337 S	12/2002	Feng
D530,548 S	10/2006	McCurry
D539,569 S	4/2007	Lewis
D582,169 S	12/2008	Skalka
D583,577 S	12/2008	Wicha
D591,090 S	4/2009	Judkins
D599,570 S	9/2009	Skalka
D611,735 S	3/2010	Stukenberg
D611,736 S	3/2010	Navone
D651,651 S	1/2012	Beukema et al.
D657,978 S	4/2012	Hamm et al.
D659,415 S	5/2012	Soto et al.
D661,935 S	6/2012	Kozak et al.
D672,594 S	12/2012	Kozak et al.

D678,696 S	3/2013	Hamm et al.	
D679,521 S	4/2013	Hamm et al.	
D686,438 S	7/2013	Denby et al.	
D688,494 S	8/2013	Hamm et al.	
D693,156 S	11/2013	Hamm et al.	
D693,610 S	11/2013	Denby et al.	
D694,557 S	12/2013	Rodgers	
D694,558 S	12/2013	Denby et al.	
D705,556 S	5/2014	Udagawa	
D711,171 S	8/2014	Brielmaier	
D713,190 S	9/2014	Behar	
D713,658 S	9/2014	Smeds et al.	
D717,554 S	11/2014	Kapka	
D727,644 S	4/2015	Sorel	
D728,281 S	5/2015	Heirakuji et al.	
D729,560 S	5/2015	Hamm et al.	
D730,071 S	5/2015	Sorel	
D734,631 S	7/2015	Velez	
D740,595 S	10/2015	Kim et al.	
D741,616 S	10/2015	Sneve et al.	
D750,921 S	3/2016	Kozak	
D753,419 S	4/2016	Heirakuji et al.	
D758,106 S	6/2016	Hamm et al.	
D763,016 S	8/2016	Clark et al.	
D766,630 S	9/2016	Akana et al.	
D766,631 S	9/2016	Akana et al.	
D767,310 S	9/2016	Akana et al.	
D769,021 S	10/2016	Green et al.	
D769,654 S	10/2016	Akana et al.	
D776,471 S	1/2017	Mandon et al.	
D783,324 S	4/2017	Akana et al.	
D787,247 S	5/2017	Price et al.	
D788,506 S	6/2017	Choi	
D795,613 S	8/2017	Hamm et al.	
D796,234 S	9/2017	Thaler et al.	
D796,235 S	9/2017	Morrell	
D810,476 S	2/2018	Heirakuji et al.	
D821,116 S	6/2018	Hamm et al.	
D846,313 S	4/2019	Carral O' Gorman	
D859,892 S	9/2019	Tio et al.	
D869,210 S	12/2019	Mangold	
D873,056 S	1/2020	Stafford et al.	
D877,548 S *	3/2020	Brugger	D6/675
D885,800 S	6/2020	Mills	
D889,887 S *	7/2020	DeJesus	D6/675
D894,645 S	9/2020	Ohmoto et al.	
D900,513 S	11/2020	Li	
D917,937 S *	5/2021	DeJesus	D6/675

* cited by examiner

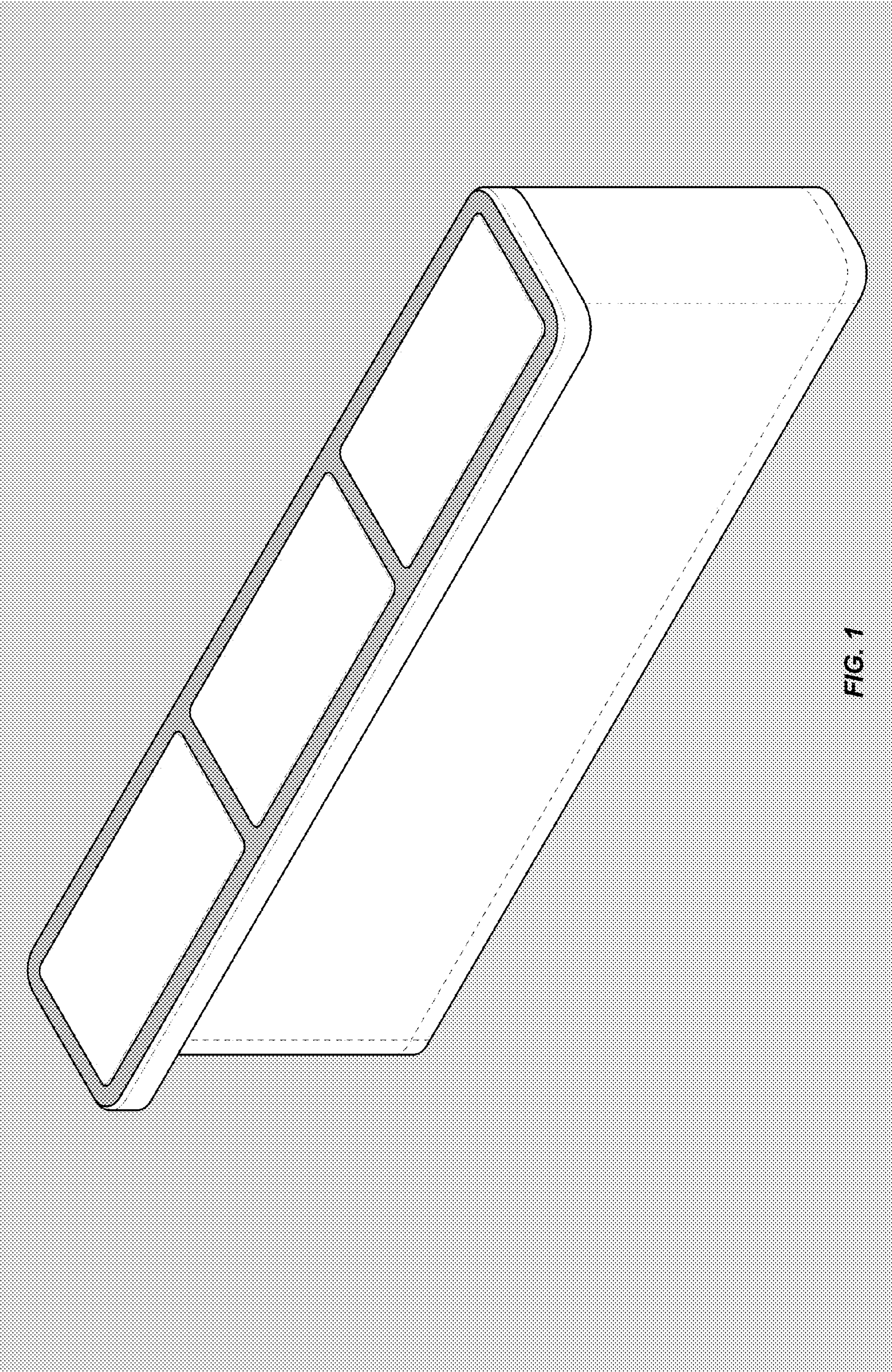

FIG. 1

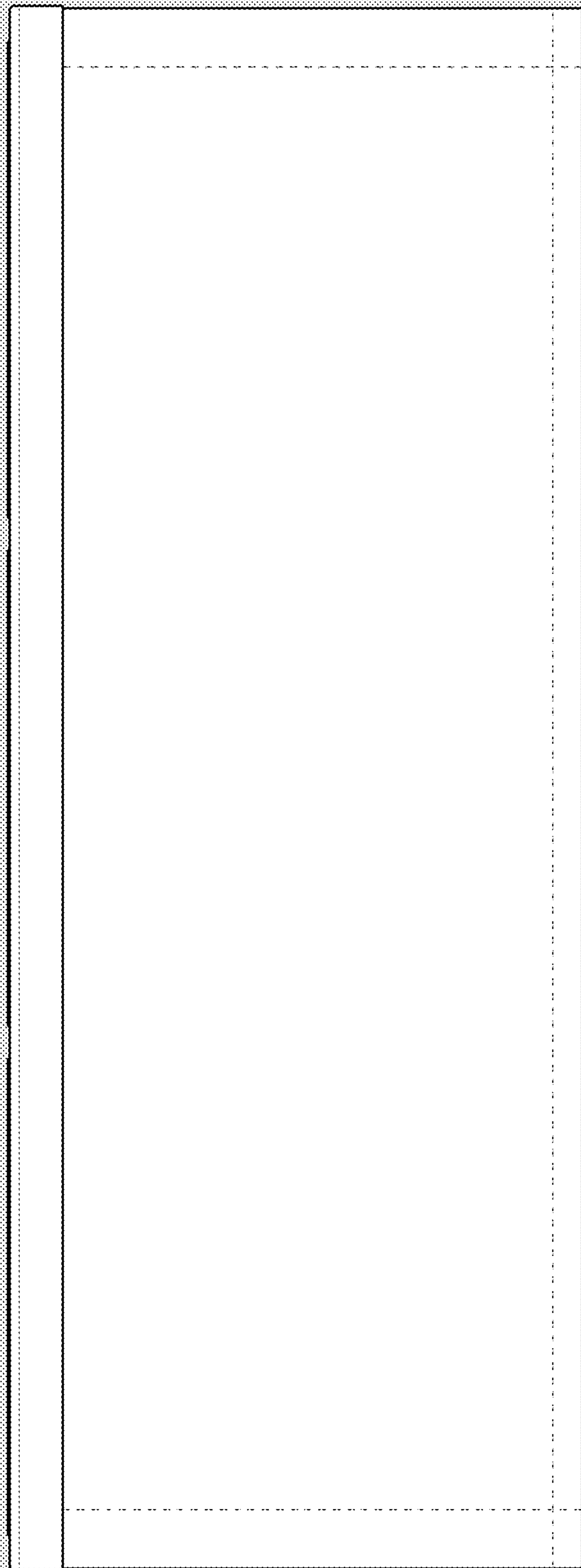

FIG. 2

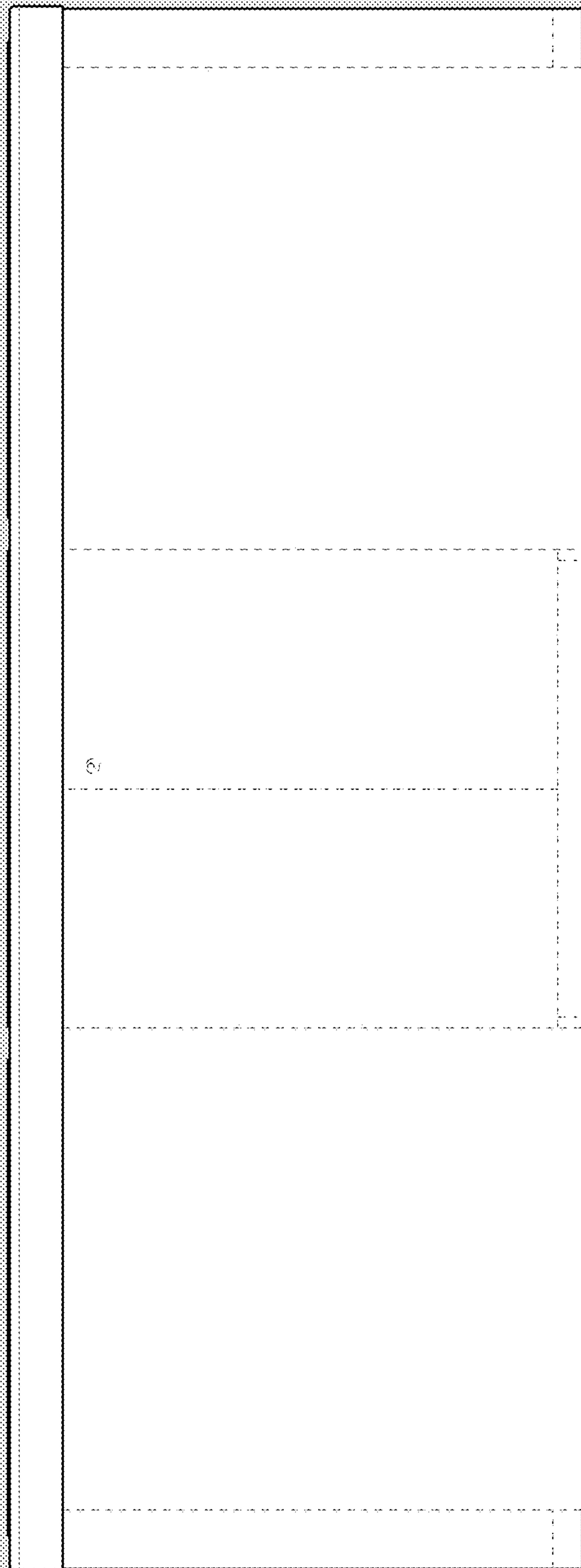

FIG. 3



FIG. 4

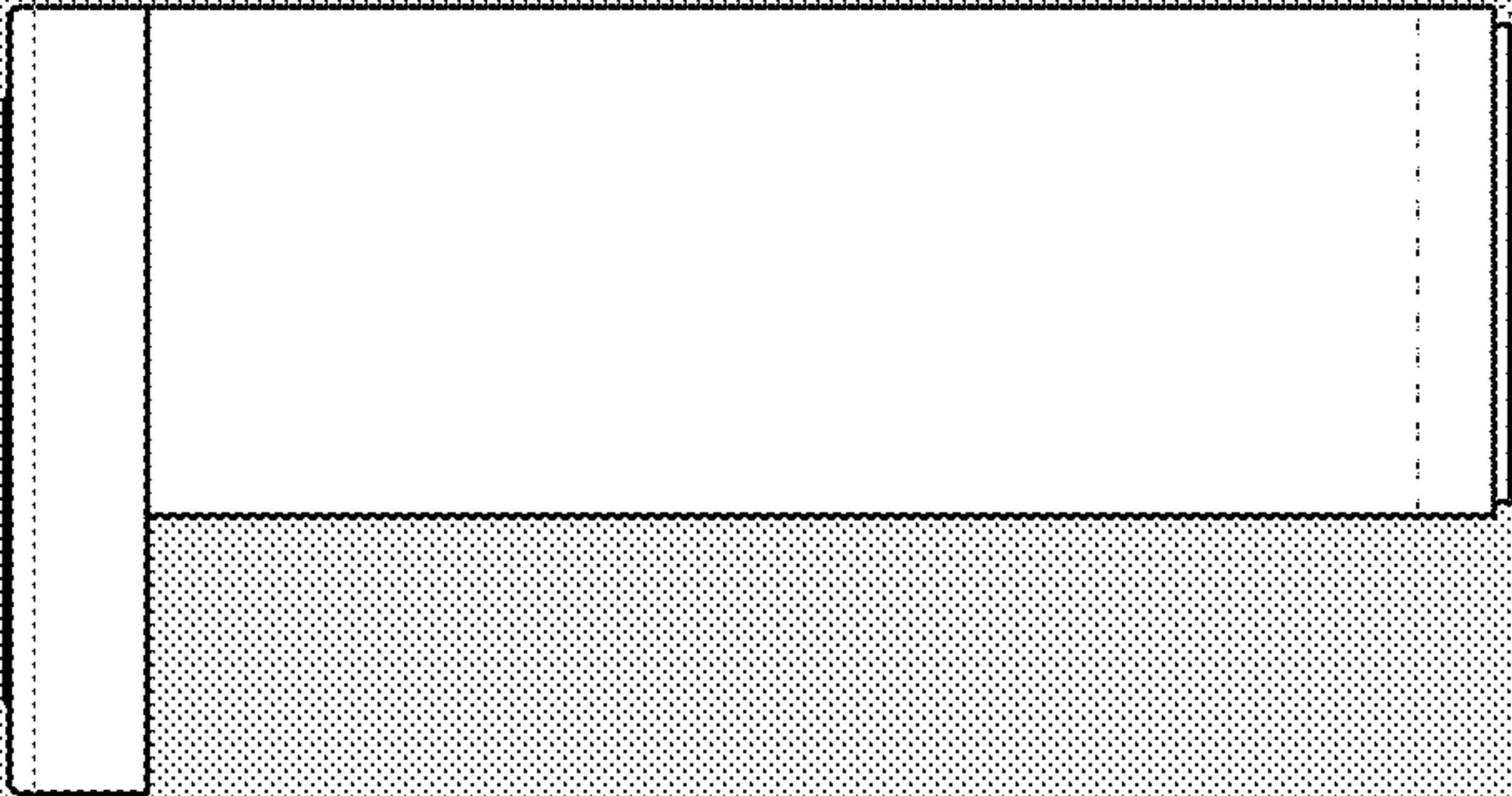

FIG. 5

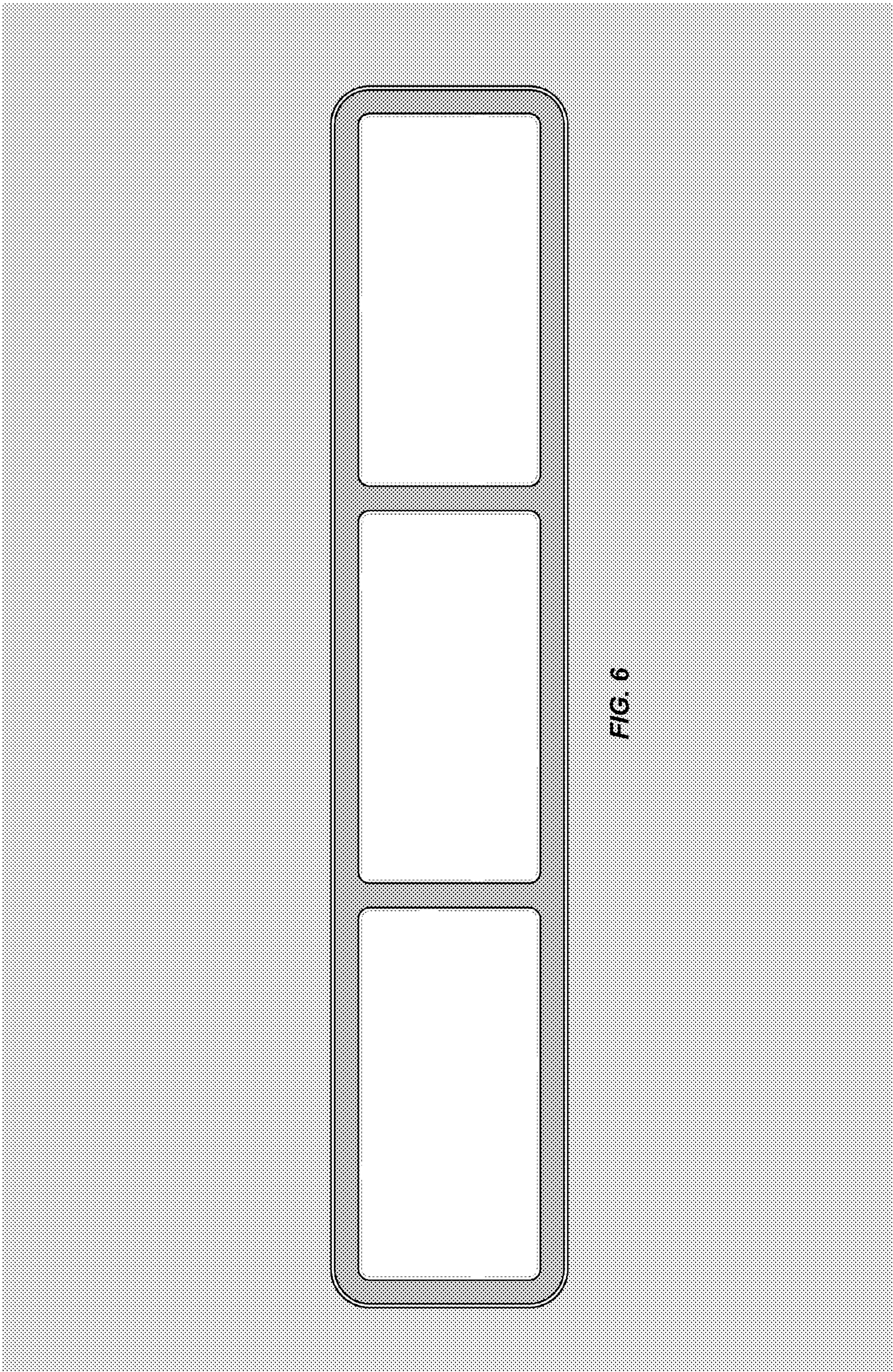

FIG. 6

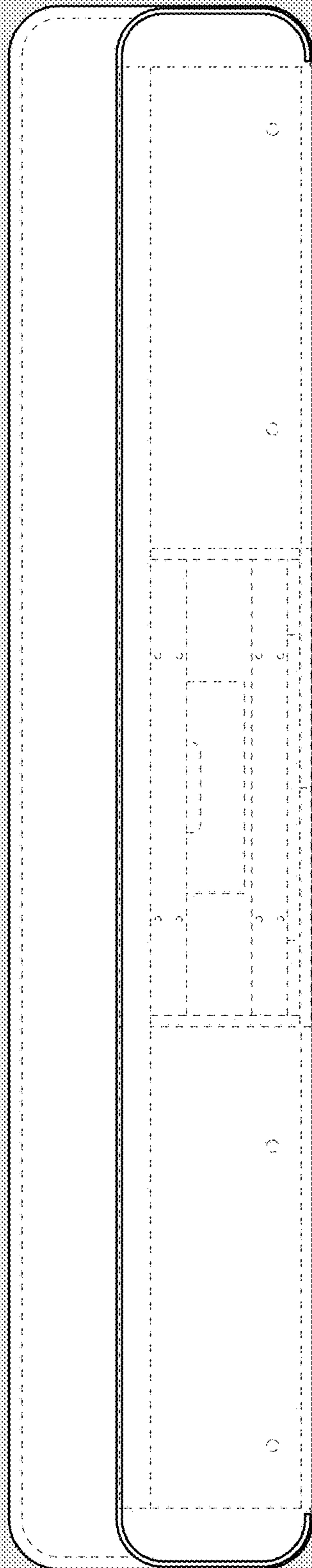

FIG. 7

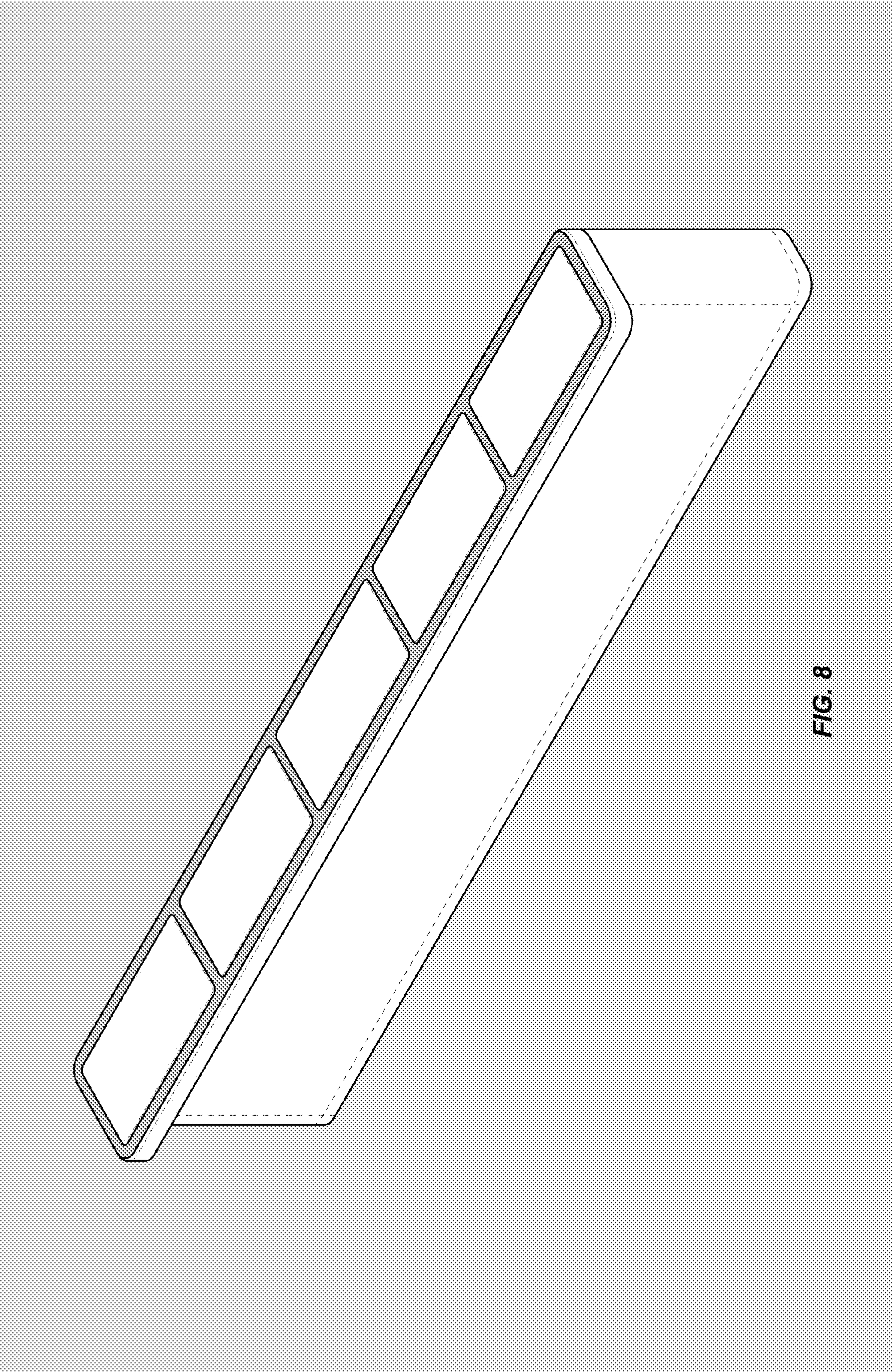

FIG. 8

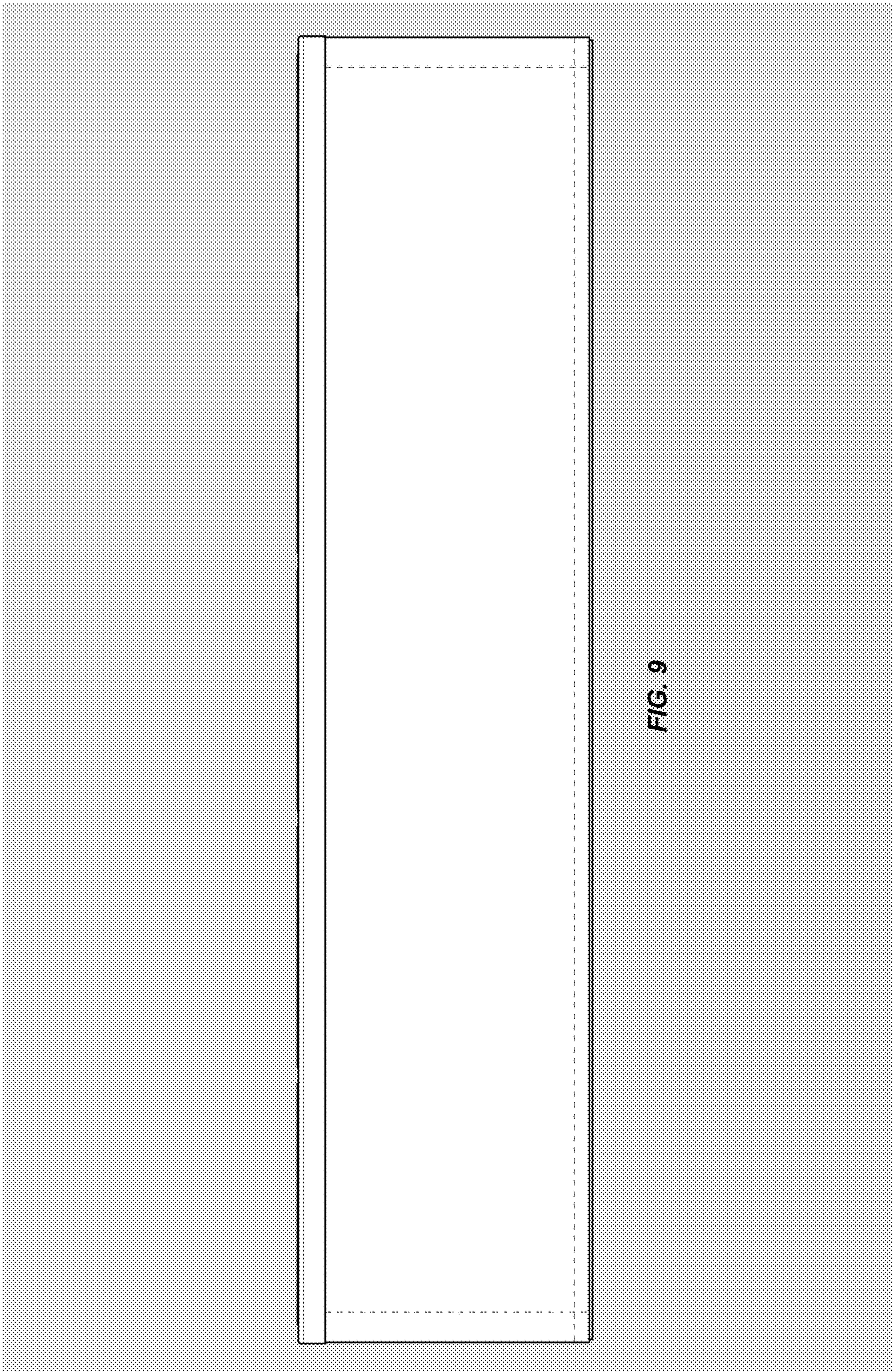

FIG. 9

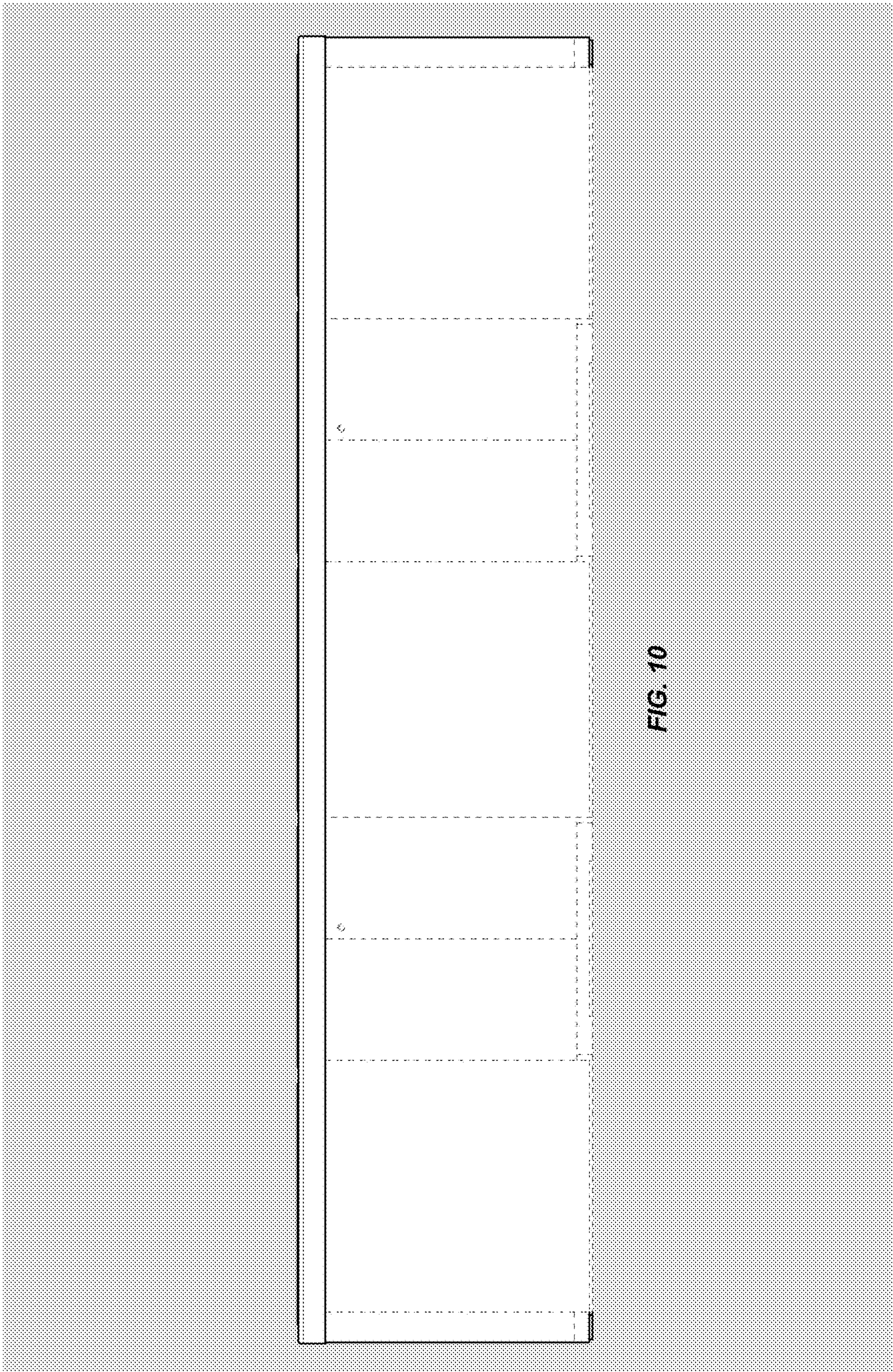

FIG. 10



FIG. 11



FIG. 12

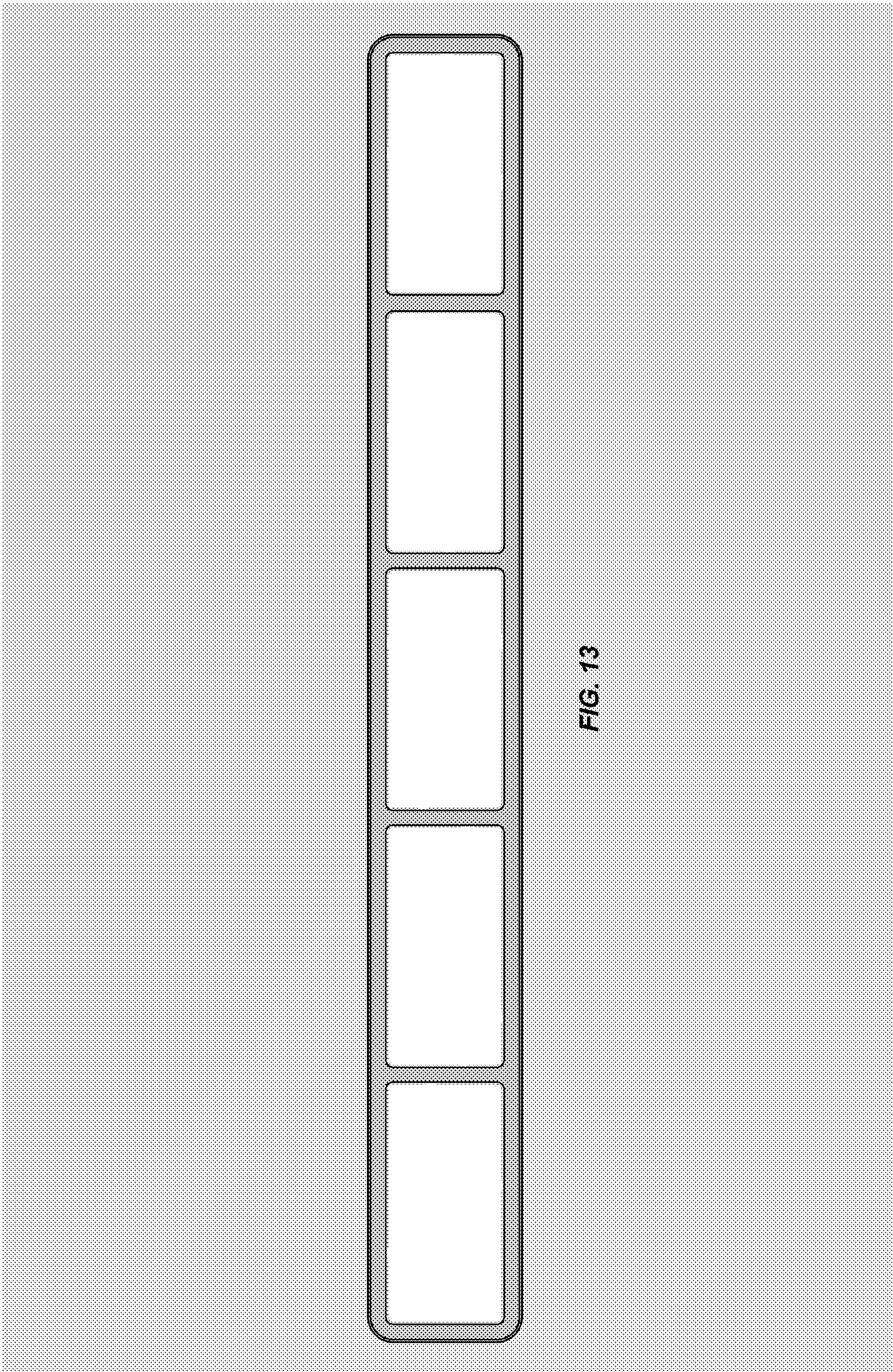

FIG. 13

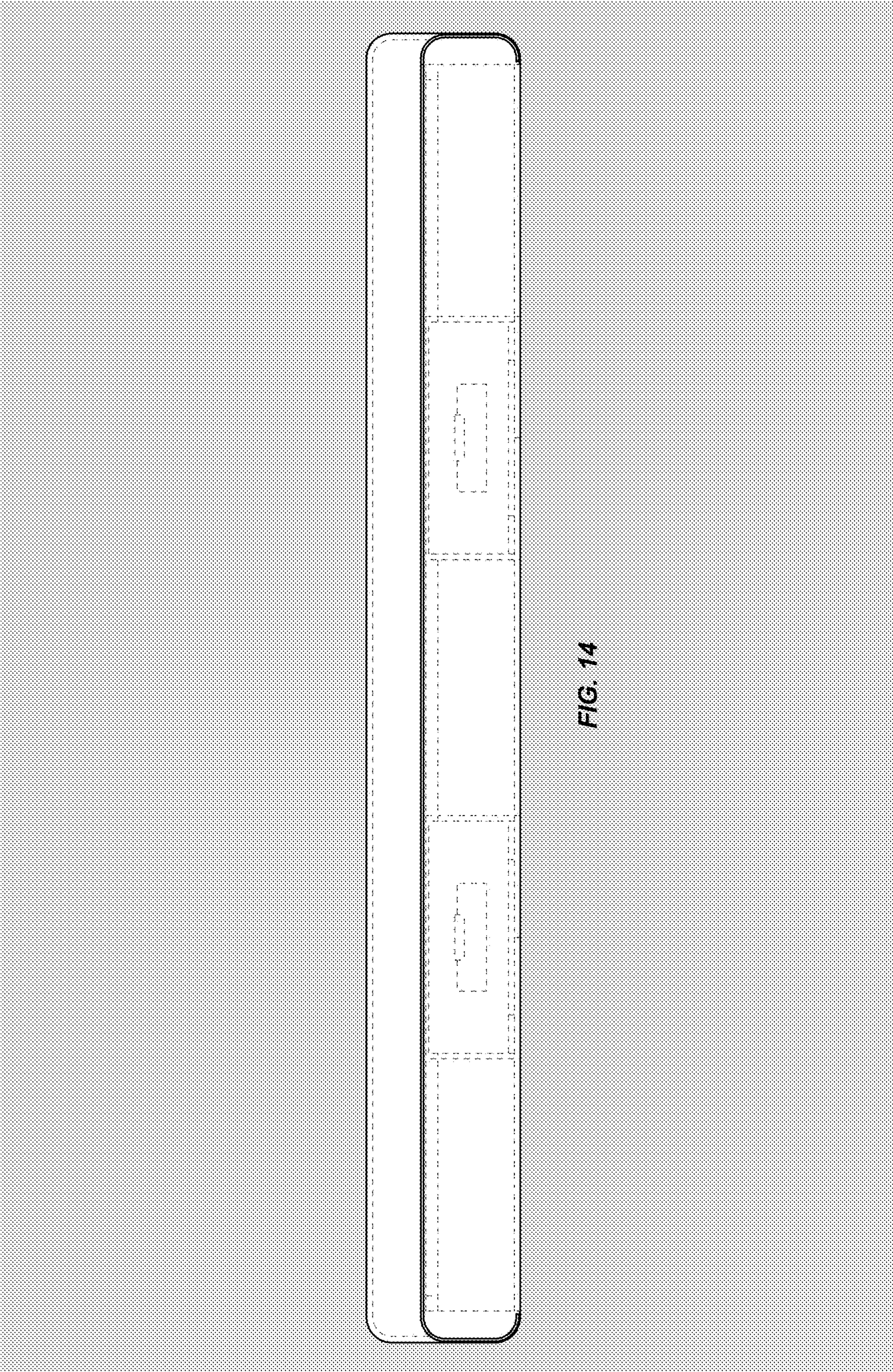

FIG. 14